

Uputstvo za upotrebu

KONČAR mašina za pranje veša PRT138MDINVG

KONČAR



Tehnoteka je online destinacija za upoređivanje cena i karakteristika bele tehnike, potrošačke elektronike i IT uređaja kod trgovinskih lanaca i internet prodavnica u Srbiji. Naša stranica vam omogućava da istražite najnovije informacije, detaljne karakteristike i konkurentne cene proizvoda.

Posetite nas i uživajte u ekskluzivnom iskustvu pametne kupovine klikom na link:

<https://tehnoteka.rs/p/koncar-masina-za-pranje-vesa-prt138mdinvg-akcija-cena/>

KONČAR

HR

EN

UPUTE ZA UPORABU OWNER'S MANUAL

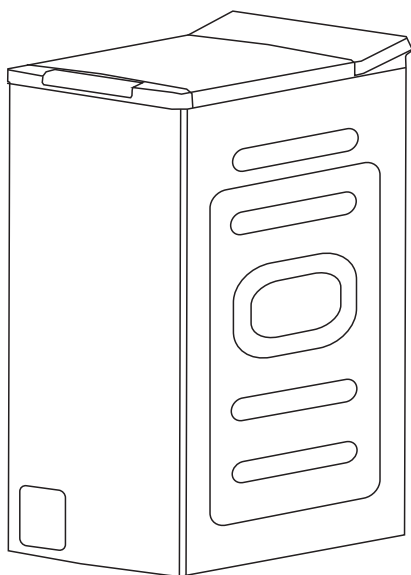

PERILICA RUBLJA WASHING MACHINE

PRT138MDINVG

KONČAR - KUĆANSKI APARATI d.d.
Slavonska avenija 16 , 10001 Zagreb , Hrvatska
tel : ++ 385 1/2484 555
fax : ++ 385 1/2404 102
www.koncar-ka.hr



ŠTOVANI KUPCI,

zahvaljujemo Vam na povjerenju koje ste nam ukazali kupnjom našeg proizvoda.



Za Vaše lakše snalaženje prilikom uporabe aparata, pripremili smo ove Upute za uporabu.

Molimo Vas da pažljivo pročitate ove "Upute za uporabu" jer ćete na taj način izbjeći greške, povećati uporabno trajanje aparata, štedjeti energiju i novac.

Upute su dostupne na web adresi: **www.koncar-ka.hr**

Upute za uporabu odložite na sigurno mjesto kako bi ih mogli koristiti i za buduće potrebe. Ako aparat prodate ili ustupite drugom vlasniku tada uz aparat priložite i ove upute.



POZOR! VRUĆA POVRŠINA!



POZOR! OPASNOST OD POŽARA!

U uputama za uporabu mogu biti opisani različiti tipovi aparata koji se međusobno razlikuju po opremljenosti i načinu rada, te su zbog toga uključena i neka poglavlja, crteži i podaci koji za Vaš aparat ne dolaze u obzir.

Pridržavamo pravo izmjena i grešaka u uputama za uporabu.

Tehničke specifikacije i ovaj priručnik podložni su promjenama bez prethodne obavijesti ili najave.

SADRŽAJ

UVOD

- 3 Važne opće informacije
- 4 Informacije o jamstvu
- 5 Sigurnosna upozorenja

POSTAVLJANJE I PRIKLJUČENJE APARATA

- 13 Opis proizvoda
- 14 Postavljanje i priključenje

UPORABA APARATA

- 17 Brze upute
- 18 Prije svakog pranja
- 19 Ladica za deterdžent
- 21 Upravljački elementi i njihova uporaba
- 22 Tablica programa i informacije
- 26 Funkcije i dodaci

ODRŽAVANJE APARATA

- 27 Čišćenje i održavanje
- 30 Problemi te njihovo moguće uklanjanje
- 32 Tehnički podaci

Važne opće informacije

Ovaj aparat je namijenjen isključivo za uporabu u domaćinstvu i sličnim okruženjima kao što su:

- priručne kuhinje za osoblje u trgovinama, uredima i drugim radnim okruženjima;
- korištenje od strane gostiju u hotelima, motelima i drugim smještajnim prostorima;
- gospodarske zgrade na farmama;
- objekti koji nude usluge noćenja s doručkom
- područja za komunalne uporabe u stambenim zgradama (zajedničke prostorije za pranje i sušenje rublja).

Aparat nije namijenjen uporabi u profesionalne (komercijalne) svrhe ili namjene koje nadilaze uobičajenu uporabu u domaćinstvu.

Ako se aparat ipak tako upotrebljava, tada proizvođač ne snosi nikakvu odgovornost, a jamstvo ne vrijedi.

Proizvođač ne snosi nikakvu odgovornost za ozljede ili oštećenja izazvana nepravilnim postavljanjem ili uporabom te ne priznaje pravo na jamstvo u slučaju nepridržavanja uputa za uporabu i nesavjesne uporabe aparata.

Proizvođač zadržava pravo promijeniti konstrukciju, mjere i težinu ako to smatra potrebnim radi poboljšanja kvalitete proizvoda, bez ugrožavanja osnovnih svojstava proizvoda i bez prethodne najave.

U uputama za uporabu mogu biti opisani različiti tipovi aparata koji se međusobno razlikuju po opremljenosti i načinu rada, te su zbog toga uključena i neka poglavlja, podaci i crteži koja za Vaš aparat ne dolaze u obzir.

ODLAGANJE PROIZVODA

Ovi proizvodi su razvijeni i proizvedeni uz uporabu kvalitetnih materijala i komponenti koje je moguće reciklirati i ponovo iskoristiti. Simbol s lijeve strane znači da se električni i elektronički aparati na kraju njihova uporabnog vijeka ne smiju odbacivati zajedno s ostalim kućnim otpadom.



Molimo da ovaj aparat predate lokalnoj tvrtki koja se bavi zbrinjavanjem otpada ili ga odnosi u reciklažno dvorište. Ovaj aparat zadovoljava EU direktivu (2012/19/EU) u svezi zbrinjavanja električnog i elektroničkog otpada (WEEE). Ovaj aparat zadovoljava EU RoHS direktivu (2011/65/EU).

Korisnik ne smije rastavljati aparat ili ostale komponente. Taj posao obavlja ovlaštena tvrtka koja se bavi recikliranjem takve vrste otpada.

Ambalaža je izrađena tako da ne ugrožava okoliš; ambalažni materijal je ekološki i može se preraditi, odnosno reciklirati. Nije dozvoljeno odlagati ambalažni materijal s ostalim kućnim otpadom, nego ga je poterbno odložiti na zato namjenenom mjestu.



Informacije o jamstvu

Ako do nekog kvara na aparatu dođe tijekom jamstvene dobi, nemojte ga popravljati sami.

Reklamaciju odmah prijavite na jedno od servisnih mjesta jer u suprotnom može doći do većeg oštećenja aparata, za što proizvođač neće preuzeti nikakvu odgovornost.

Pri podnošenju reklamacije držite se teksta

Jamstvenog Lista. Najnovije informacije o servisnim mjestima nalaze se na web stranici www.koncar-ka.hr

Bez predaje pravilno popunjenog Jamstvenog lista i priloženog računa za kupljeni aparat reklamacija je nevažeća.

SIGURNOSNA UPOZORENJA

NE RABITE APARAT PRIJE NEGO PROČITATE UPUTE ZA UPORABU I UPOZNATE SE S NJEGOVOU UPORABOM.



Upute za uporabu odložite na sigurno mjesto kako bi ih mogli koristiti i za buduće potrebe. Ako aparat prodate ili ustupite drugom vlasniku tada uz aparat priložite i ove upute.

Zbog Vaše sigurnosti, morate se pridržavati naputaka u ovim uputama te na taj način smanjiti rizike od požara, eksplozija, električnog udara, oštećenja imovine, opasnosti po okoliš, ozljedama osoba s ozbiljnim ili tragičnim (smrtnim) posljedicama.

⚠ POZORNOST!

Ova kombinacija simbola i riječi označava potencijalno opasnu situaciju koja može rezultirati opasnim ozljedama osoba, oštećenjem imovine, opasnosti po okoliš, te tragične (smrtne) posljedice.

POZORNOST! Proizvođač/distributer ne preuzima nikakvu odgovornost za oštećenja nastala prilikom uporabe neuzemljenog aparata, te u svezi bilo kakvog oštećenja i povreda ako se ne pridržava uputa za uporabu, u slučaju nesavjesne i nepravilne uporabe aparata, samostalnih popravaka i modifikacija te uporabe dijelova koji nisu originalni i odobreni od proizvođača.

Ako do nekog kvara na aparatu dođe, nemojte ga popravljati sami, nego kvar odmah prijavite na jedno od servisnih mjesta, jer u suprotnom može doći do većeg oštećenja aparata.

Ovaj aparat je namijenjen isključivo za uporabu u domaćinstvu (i sličnim okruženjima) i unutar zatvorenih prostora, te nije namijenjen uporabi u profesionalne (komercijalne) svrhe ili namjene koje nadilaze uobičajenu uporabu u domaćinstvu.

Ako se aparat ipak tako upotrebljava, tada proizvođač ne snosi nikakvu odgovornost, a jamstvo ne vrijedi.

⚠ POZORNOST! SIGURNOST DJECE!

⚠ POZORNOST! Po primitku aparata, raspakirajte ga, ambalažni materijal (plastičnu foliju, stiropor, drvo...) uklonite izvan domašaja djece kako se djeca ne bi ozljedila (progutala manje komade ili se ugušila plastičnom folijom).

⚠ OPREZ! Ambalažni materijal (plastična folija, stiropor, drvo...) je opasan za djecu. Djeci nemojte dozvoliti igranje ambalažnim materijalom, kako ne bi progutala manje komade ili se ugušila plastičnom folijom.

⚠ POZORNOST! Ovaj aparat mogu upotrebljavati djeca u dobi od osam godina i starija te osobe sa smanjenim tjelesnim, osjetnim ili duševnim sposobnostima ili pomanjkanjem iskustva i znanja ako dobiju nadzor ili uputu o uporabi aparata na siguran način te razumiju uključene opasnosti.

⚠ POZORNOST! Djeci onemogućite penjanje na aparat ili ulaz u bubanj jer postoji opasnost sa tragičnim posljedicama.

⚠ POZORNOST! Omekšivače rublja, deterdžente i slične proizvode držite izvan dohvata djece.

⚠ POZORNOST! Ne ostavljajte djecu bez stalnog nadzora u blizini aparata.

⚠ POZORNOST! Djeca ne smiju koristiti aparat za igru.

⚠ POZORNOST! Čišćenje i korisničko održavanje ne smiju obavljati djeca bez nadzora. Isto vrijedi i za maloljetne osobe.

Ovaj aparat nije namijenjen osobama (uključujući djecu mlađu od 3 godine) koje imaju smanjene fizičke, osjetne ili mentalne sposobnosti, kao i osobama koje nisu dovoljno iskusne i informirane, osim ako ih se nadgleda ili ako su dobile upute o uporabi aparata od osobe odgovorne za njihovu sigurnost.

Kućni ljubimci moraju biti pod stalnim nadzorom te im se mora onemogućiti penjanje po aparatu, zavlacenje u isti, kao i griženje kablova. Prije uporabe aparata obavite provjeru!

Nije dozvoljeno penjanje niti sjedenje na aparatu.

⚠ POZORNOST! OPASNOST OD OPEKLINA!

Površina vrata, stakla, cijev za odvod vode te dijelovi aparata mogu biti jako vrući tijekom rada pa stoga može doći do opekline. Zbog toga djeca i kućni ljubimci moraju biti udaljeni od aparata te pod stalnim nadzorom.

**⚠ POZORNOST!
OPASNOST OD ELEKTRIČNOG UDARA!**

Električna sigurnost aparata zajamčena je jedino ako je ono ispravno spojeno na ispravnu i propisnu električnu instalaciju s uzemljenjem.

Aparat obvezatno mora biti uzemljen!

Budite uvjereni kako priključni vod nije oštećen, prignječen ili zapetljan tijekom instalacije, ne zatežite priključni vod.

Ne uključujte aparat u električnu instalaciju ako je priključni vod oštećen.

Oštećeni priključni vod mora biti zamijenjen ispravnim, a smije ga zamijeniti jedino stručna osoba ili serviser.

Nestručno priključenje i popravci mogu uzrokovati električni udar i tjelesne ozljede.

Aparat se priključuje na propisno instaliranu zidnu priključnicu s kontaktom za uzemljenje s vlastitim strujnim krugom i osiguračem. Zidna priključnica mora biti uzemljena, lako pristupačna, ne smije biti izložena toplinskom zračenju i vlazi.

Priključnica i instalacija mora izdržati struju koja je uvijek veća od one potrebne za aparat.

Aparat nije dozvoljeno priključiti na električnu instalaciju preko produžnih kablova i/ili vanjskih timera ili sličnih uređaja i daljinskih kontrolera.

Ne dodirujte aparat mokrim rukama dok je uključen u električnu instalaciju te nemojte biti bos i dok se služite aparatom.

Nakon uporabe aparata, obvezatno ga odspojite od električne mreže (povlačeći utikač iz utičnice, ali samo suhim rukama) te zatvorite dovod vode.

⚠ POZORNOST! OPASNOST OD EKSPLOZIJE!

Aparat se ne smije koristiti u prostorijama gdje se pojavljuju zapaljive i/ili eksplozivne pare ili kemikalije.

Ne smije se prati ili sušiti rublje koje je čišćeno, namočeno, prano ili trljano zapaljivim ili eksplozivnim sredstvima koja su ostala na rublju (kao što su trikloretilen, benzin, aceton, vosak, ulje, odmašćivači, petrolej, itd.) jer bi moglo doći do požara ili eksplozije.

Ispušni zrak iz aparata ne smije biti usmjeren u kuhinjsku napu ili na odvod zraka koji koriste kućanski aparati na plin ili druga goriva.

**Aparat se ne smije koristiti ako se industrijske kemikalije koriste za čišćenje rublja.
Nije dozvoljeno držati zapaljive tvari u blizini ili na aparatu jer bi se mogle zapaliti.**

POZORNOST U SVEZI S POSTAVLJANJEM APARATA

Priključak za vodu i struju mora biti izveden prema nacionalnim propisima i sigurnosnim odredbama, te od strane ovlaštenog, stručnog i kvalificiranog osoblja.

Potrebno je ukloniti sve transportne blokade prije uporabe aparata jer može doći do ozbiljnih oštećenja.

Aparat je namjenjen samo za unutarnju uporabu.

Aparat nije ugradbeni, niti je predviđen za ugradnju u elemente.

Aparat ne smije biti instaliran iza prepreka (npr vrata, klizna vrata i sl.) jer se time onemogućuje potpuno otvaranje vrata na aparatu.

Aparat se ne smije postaviti u prostorijama koje su zaparene, vrlo vlažne (npr. kupaona) ili gdje se pojavljuju zapaljive, eksplozivne ili korozivne pare.

Aparat se ne smije postavljati na tepih ili podne obloge kako se ne be zaklonili ili zatvorili otvori na aparatu.

Opasnost od smrzavanja! Ne postavljajte aparat u prostorijama gdje može doći do smrzavanja ili na temperaturama blizu nule. Pri tome može doći do smrzavanja vode u pumpi, crijevima, bubnju, itd.

Aparat ne koristite pri temperaturama nižim od 5°C.

Priključci aparata (voda, odvod, struja) moraju biti dostupni nakon postavljanja.

Za priključak na vodu potrebno je koristiti novo crijevo koje je isporučeno uz aparat, a ne staro ili prije upotrebljavano crijevo. Crijevo se priključuje samo na hladnu vodu tlaka od min. 0,05 MPa do max. 1 MPa.

Crijeva za priključak na vodu i odvod moraju biti dobro pričvršćena i osigurana, te neoštećena, inače bi moglo doći do procurivanja vode.

POZORNOST U SVEZI NEPRAVILNE UPORABE

Aparat je namjenjen samo za uporabu u kućanstvu te za pranje-sušenje tekstila koji je prikladan za strojno pranje-sušenje.

Nije dozvoljeno penjati se, sjediti ili stavljati teške predmete na gornju ploču aparata.

Nije dozvoljeno naslanjati se na vrata aparata.

Ne izlažite aparat sunčevom zračenju.

Aparat se ne smije pomicati tijekom rada ili održavanja.

Ne vadite utičnicu iz utikača potezanjem priključnog voda. Nemojte presavijati ni oštećivati priključni vod, te ga nemjote uključivati - isključivati mokrim rukama.

Nemojte deinstalirati i instalirati aparat bez uputa ili nadzora.

Nije dozvoljeno prati tepihe.

Ne čistite aparat mlazom vode ili visokotlačnim parnim aparatom za čišćenje.

Ne stavljajte u perilicu više rublja od preporučenog.

Držite se maksimalnog dozvoljenog kapaciteta.

Nemojte zatvarati vrata prejakom silom. Ako se vrata teško zatvaraju, potrebno je provjeriti da li odjeća sprječava zatvaranje ili je uklještena u šarnir vrata.

POZORNOST U SVEZI UPORABE APARATA

Prije uprabe aparata preporučuje se kalibracija istoga, kako bi bolje radio (ako je ta opcija ugrađena).

Ako se aparat koristi po prvi put, potrebno je izvršiti jedan ciklus pranja bez odjeće.

Rabite samo odgovarajuće deterdžente i omekšivače koji su namjenjeni za strojno pranje rublja, a u skladu s uputama proizvođača dotičnih sredstava.

Zabranjeno je korištenje zapaljivih, eksplozivnih i štetnih otapala (benzin, alkohol, itd) umjesto deterdženta.

Provjerite da u džepovima odjeće, koju stavljate u aparat, nema kakvih predmeta (upaljači, mobiteli, igle, novčići, šibice, vijci, itd.) jer bi mogli oštetiti aparat.

Provjerite da li je voda u bubnju ispražnjena prije otvaranja vrata. Ako je voda u bubnju tada nije dozvoljeno otvaranje vrata.

Obratite pozornost i ne dodirujte odvodno crijevo tijekom pražnjenja vruće vode jer bi se mogli opeći.

Ne otvarajte filter pumpe ako je voda u aparatu jer može isteći velika količina, a voda može biti i vruća pa postoji opasnost od opekline.

Ne pokušavajte otvarati vrata na silu. Nakon završetka programa potrebno je pričekati do dvije minute kako bi se mogla otvoriti vrata.

Nije dozvoljeno ručno nadopunjavanje vode tijekom pranja.

Prostorija u kojoj se nalazi aparat mora se dobro provjetravati kako bi se spriječio povratni tok plinova koje ispuštaju aparati koji izgaraju plin i ostale energente (npr. peći, štednjaci i sl.).

Aparati čija se vrata mogu otvoriti tijekom pražnjenja vode, potrebno je pričekati oko 15 sekundi dok se ne završi proces pražnjenja vode.

Rublje koji sadrže lateks i gumene dijelove, kape za kupanje i tuširanje, rublje od vodonepropusnih tkanina, rublje, jastuci ili prevlake s spužvastom gumom, zabranjeno je sušiti u aparatu.

Rublje koje je bilo natopljeno zapaljivim ili kemijskim sredstvima (ulje, alkohol, benzin, aceton, vosak, ulje, odstranjivači mrlja, terpentini, petroleji) mora biti suho pa onda oprano u vrućoj vodi s više deterdženta, a tek se onda može sušiti u aparatu.

Nije dozvoljeno sušenje neopranog rublja.

Završni dio ciklusa pranja-sušenja izvršava se bez topline (ciklus hlađenja) kako bi rublje ostalo na temperaturi koja ga neće oštetiti (za perilice-sušilice).

POZOR! Nikada ne zaustavljajte aparat prije kraja programa, a ako se to mora tada rublje treba brzo izvaditi i rasprostrjeti kako bi se ohladilo. Rublje u bubnju je vruće i potreban je oprez prilikom vađenja jer može doći do opekline.

Nakon završetka programa i uporabe, potrebno je isključiti aparat, izvaditi utičnicu priključnog kabela iz električnog priključka te zatvoriti dovod vode.

Prije svakog čišćenja i održavanja, aparat obvezatno isključite iz električne mreže povlačeći utikač iz utičnice, ali samo suhim rukama!

POZORNOST U SVEZI POPLAVE

Poduzmite odgovarajuće mjere za sprječavanje proklizavanja cijevi na umivaoniku, jer snaga vode koja prolazi kroz cijev, koja nije postavljena na odgovarajući način, može pomaknuti cijev. Cijev mora biti učvršćena. Postavite čep umivaonika tako da ne zatvara odvod umivaonika.

Provjerite priključke na vodu i odvod, jer ako nisu dobro učvršćeni i osigurani, može doći do curenja vode.

POSTAVLJANJE I PRIKLJUČENJE

Opis proizvoda

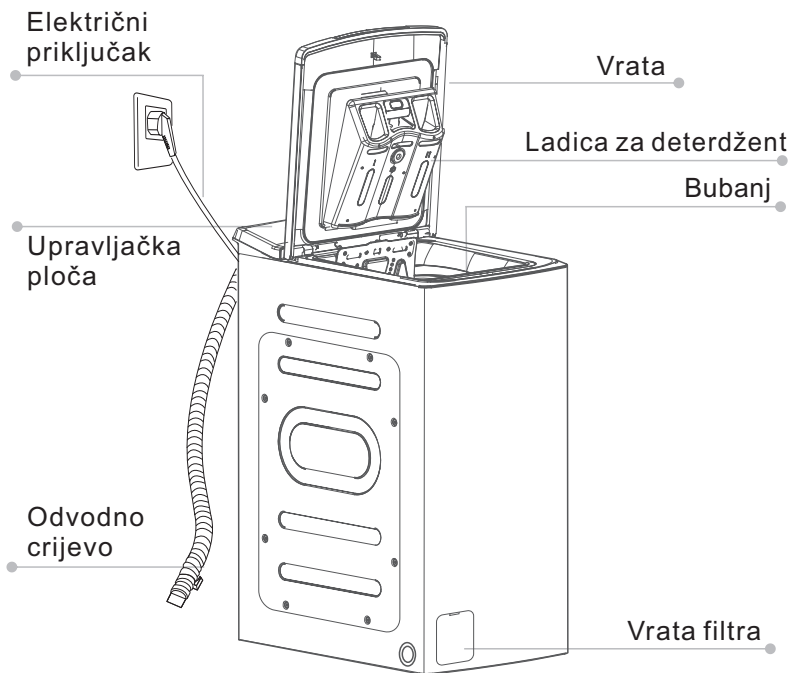

Prikazani crteži su samo informativne naravi i mogu se razlikovati od stvarnog proizvoda. Neki dijelovi mogu biti opcija i ne moraju biti uključeni u proizvod. U uputama za uporabu mogu biti opisani različiti tipovi aparata koji se međusobno razlikuju po opremljenosti i načinu rada, te su zbog toga uključena i neka poglavlja, podaci i crteži koja za Vaš aparat ne dolaze u obzir.

Pribor (ovisno o modelu)

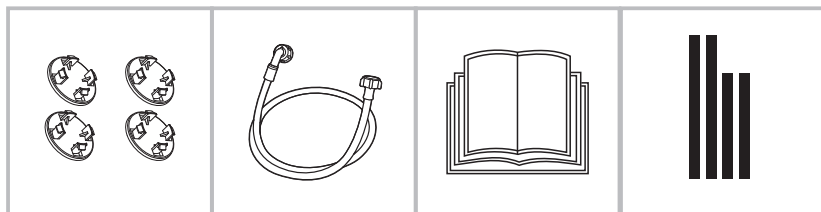

Poklopci za transportne otvore

Crijevo za priključak na hladnu vodu

Upute za uporabu

Spužve protiv buke (ovisno o modelu)

Postavljanje i priključenje

Mjesto postavljanja

⚠ Pozornost!

Stabilnost je vrlo važna kako bi se spriječilo pomicanje aparata tijekom rada (uslijed vibracija).

Pripazite kako aparat ne bi prignječio električni vod.

Prije postavljanja i priključenja aparata odaberite odgovarajući prostor s karakteristikama:

1. Suha, čvrsta i ravna podloga
2. Spriječiti direktno izlaganje sunčanim zrakama
3. Odgovarajuće prozračan ili ventiliran prostor
4. Temperatura prostora mora biti iznad 0°C
5. Aparat mora udaljen od izvora topline kao što su plin, drva/ugljen i slično.

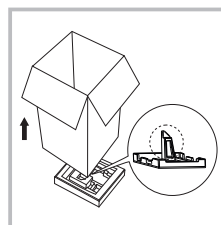
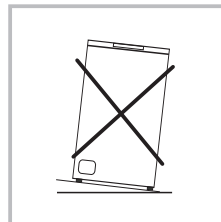

Otpakiravanje aparata

⚠ Pozornost!

Ambalažni materijal (plastičnu foliju, stiropor, drvo...) uklonite izvan domašaja djece kako se djeca ne bi ozljeđila ili ugušila.

1. Uklonite kartonsku kutiju i stiroporne umetke.
2. Podignite aparat i uklonite stiropornu bazu na kojoj aparat stoji. Obavezno uklonite stiroporni umetak (u obliku trokuta) iz donjeg dijela aparata (ako je potrebno tada nagnite aparat i izvadite umetak).
3. Uklonite ljepljive trake koje učvršćuju priključni vod i odvodno crijevo.
4. Izvadite crijevo za dovod vode iz bubnja (i ostale predmete ako su unutra).

Uklanjanje transportnih blokada (vijaka)

⚠ Pozornost!

Obavezno uklonite transportne blokade (vijke) sa stražnje strane aparata prije njegove uporabe.

Transportni vijci (blokade) su opet potrebni ako postavljate aparat na drugo mjesto, stoga vijke spremite na sigurno mjesto.

Procedura uklanjanja transportnih vijaka:

1. Olabavite 4 matice pomoću odgovarajućeg ključa te ih odvijte.
2. Pokrijte ta 4 otvora s poklopcima iz pribora.
3. Spremite transportne vijke na sigurno mjesto za buduću uporabu.

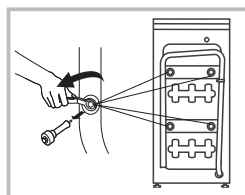

U slučaju ponovnog transporta/premještanja aparata, otkriti otvore, spremite poklopce, zavrnuti vijke (obrnuta procedura).

Uklanjanje transportnih blokada (vijaka)

⚠ Pozornost!

Obvezatno uklonite transportne blokade (vijke) sa stražnje strane aparata prije njegove uporabe, te ih spremite na sigurno mjesto. Transportni vijci su opet potrebni ako postavljate aparat na drugo mjesto.

1. Olabavite 4 vijka pomoću odgovarajućeg ključa te ih odvijte.



2. Izvucite vijke i gumene dijelove iz otvora, te ih spremite na sigurno.

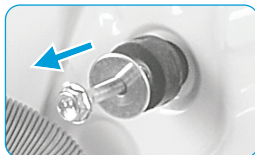

3. Pokrijte 4 otvora s poklopcima iz pribora.

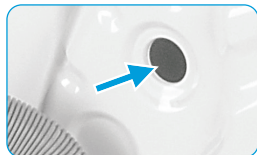

Niveliranje aparata

⚠ Pozornost!

Sve četiri matice na nožicama moraju biti čvrsto pritegnute uz dno kućišta aparata.

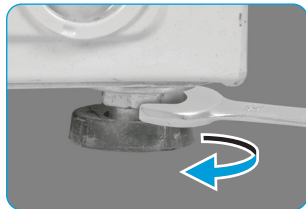

1. Olabavite sigurnosnu maticu.
2. Odvrćite odgovarajuću nožicu dok ne dođe u kontakt s podom.
3. Postavite libelu na gornju ploču aparata, te okretanjem nožica podesite ravninu. Nožice osigurajte pritezanjem sigurnosne matice ključem.

Aparat mora stajati stabilno i nivelirano na tvrdom podu. **NE POSTAVLJAJTE NIŠTA ISPOD NOŽICA** (komadiće drveta, pločice is slično).

Priključak aparata na vodu

⚠ Pozornost!

Obratite pozornost i pratite upute kako ne bi došlo do curenja vode i mogući nastanak štete. Nije dozvoljeno uvijanje, gnječenje, modificiranje ili rezanje crijeva za priključak na vodu.



Priključite crijevo za dovod vode na priključak za ulaz vode na stražnjem dijelu aparata, a drugi kraj crijeva priključite na pipu za hladnu vodu. Čvrsto zategnite plastične matice.



Priključite manualno i dobro zategnite matice bez uporabe alata. Provjeriti jesu li priključci sigurni i čvrsti, te da li propuštaju vodu.

⚠ Pozornost!

Obratite pozornost i pravilno postavite odvodno crijevo. U suprotnom može doći do curenja vode i oštećenja. Nije dozvoljeno savijanje ili produžavanje odvodnog crijeva.

Moguća su dva načina postavljanja izlaznog kraja odvodnog crijeva:

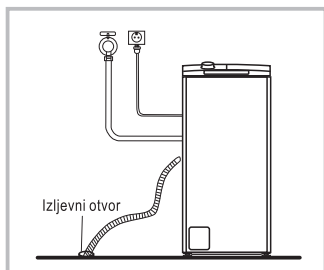

1. Umetnuti kraj crijeva u izljevni otvor i osigurati od vađenja.

Ako se u priboru aparata (ovisno o modelu) nalazi držač odvodnog crijeva, tada se postavlja kako slijedi:

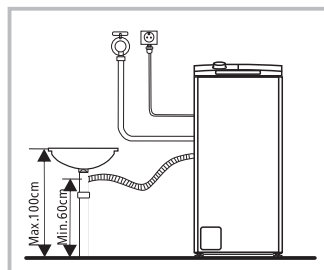
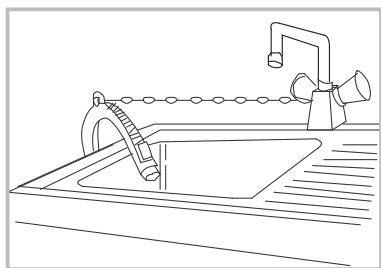

2. Umetnuti kraj crijeva u T-komad na odvodnoj cijevi umivaonika.

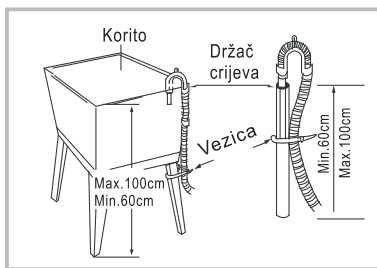

⚠ Pozornost!

Pomoću konopa (lanca) osigurati odvodno crijevo. Ako je odvodno crijevo predugo, nije dozvoljeno vraćanje istog, na silu, u aparat jer bi moglo doći do zamjetne i nekontrolirane buke.

Spužve protiv buke (ovisno o modelu)

Polegnuti aparat i zaljepiti 2 duže spužve na dulji donji rub, a 2 kraće spužve na donji kraći rub aparata.

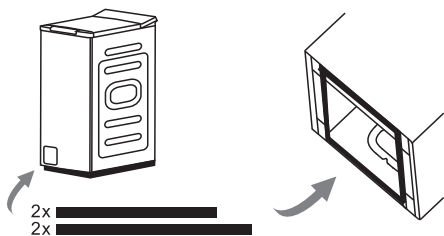

⚠ Pozornost!

NE UKLANJATI NOŽICE ZA NIVELIRANJE !

Spužve služe samo kao virtualno umanjeње buke rada aparata.

UPORABA APARATA

Brze upute



Pozornost!

Aparat mora biti propisno postavljen i priključen. Ako se aparat koristi prvi put tada bi isti trebao proći cijelu proceduru pranja ali bez odjeće i bez deterdženta.

1. Prije početka pranja

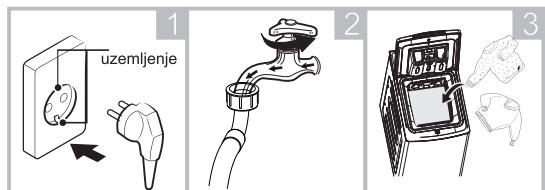

Priključiti na el. mrežu

Otvoriti pipac za dovod vode

Punjenje bubnja rubljem

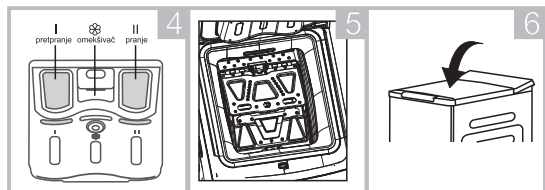

Dodati deterdžent

Zatvoriti otvor bubnja

Zatvoriti vrata

- Provjeriti okretanje bubnja prije svakog pranja - isti se mora glatko okretati.

NAPOMENA!

- Deterdžent se dodaje u odjeljak "I" samo u slučaju ako se odabere pretpiranje (ako aparat ima tu funkciju).
- Vrata na otvoru bubnja moraju biti dobro zaključana.



- Sve metalne kopče moraju biti propisno uglavljene unutar stražnjeg poklopcu vrata.

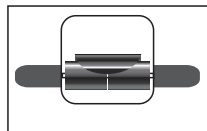

2. Pranje

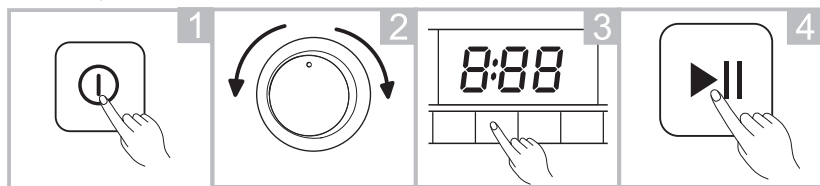

Uključiti aparat

Odabrati program

Odabrati funkciju ili ostaviti osnovno pranje

Pokrenuti proces

NAPOMENA!

Ako je odabrano osnovno pranje tada se korak 3 može i preskočiti. Izgled crteža je samo informativne naravi kako bi se pokazala procedura.

3. Nakon pranja

Ovisno o modelu, javlja se zvučni signal i/ili svjetlosni signal, ili se na displayu ispisuje poruka "End". Pričekati da se vrata otključaju, te izvaditi rublje. Isključiti aparat iz električne mreže i zatvoriti dovod vode.

Prije svakog pranja

Radni uvjeti predviđeni za aparat trebali bi biti između 5-40°C. Aparat se ne smije koristiti na temperaturama ispod 0°C jer može doći do smrzavanja te oštećenja ulaznog ventila, crijeva i pumpe. Ako se aparat nalazi na tako niskoj temperaturi, tada ga je potrebno postaviti u prostor s normalnom temperaturom, a to će osigurati da ne dođe do smrzavanja prije uporabe.

Obvezatno provjeriti podatke o deterdžentu koji će se koristiti u pranju.

Koristiti deterdžente koji se malo ili nimalo pjene, a prikladni su za strojno pranje rublja.

Obvezatno provjeriti etikete na odjevnim predmetima o vrsti tkanine, načinu pranja, najvišoj temperaturi pranja i ostalim svojstvima.

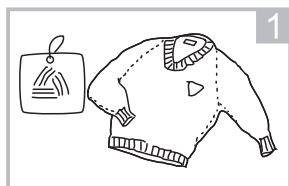

Provjeriti etikete
na rublju

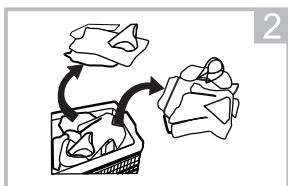

Odvojiti i složiti odjeću
prema vrstama tkanine

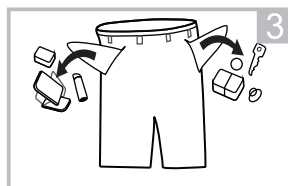

Izvaditi predmete
iz džepova

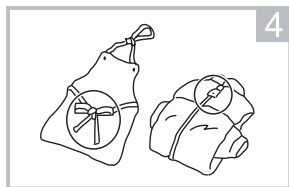

Zavezati vezice te
zatvoriti patent zatvarače

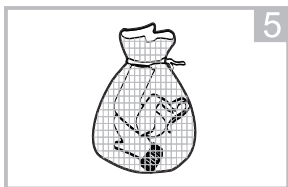

Staviti malenu ili vrlo
osjetljivu odjeću u
specijalne vreće za
pranje

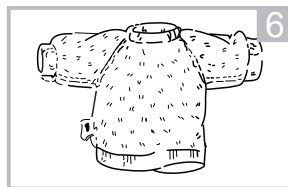

Naopako izvrnuti odjeću
kojoj strše dugi konci ili
otpada materijal (mucice)

⚠ Pozornost!

Ako se pere vrlo mala količina odjeće (1 komad), može doći do većeg ekscentriciteta te drmanja i lupanja, čime se uključuje signal za veliku nebalansiranost. Zato je preporučljivo da se doda još odjeće kako bi se postigla bolja uravnoteženost tijekom pranja.

Nije dozvoljeno pranje odjeće koja je natopljena zapaljivim materijalima (benzin, petrolej, nafta, alkohol i ostalo.) Ovo je već prije opisano.

Nije dozvoljeno pranje ili centrifugiranje vodonepropusnih sjedala, tepiha i odjeće.

Ladica za deterdžent

I Odjeljak za deterdžent za pretpranje

II Odjeljak za deterdžent za pranje

 Odjeljak za omekšivač

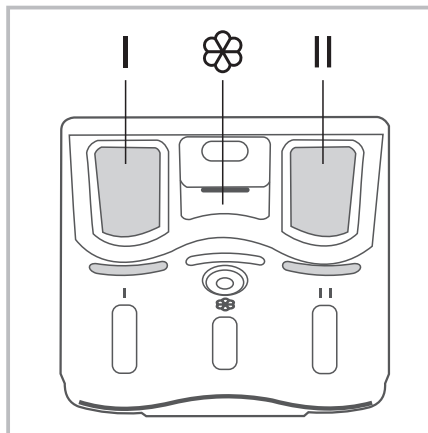

Izvučena ladica za deterdžent

NAPOMENA!

Deterdžent se dodaje u odjeljak "I" samo u slučaju ako se odabere pretpranje (ako aparat ima tu funkciju).

NE PREPORUČUJE SE prekoračenje oznake "MAX" tijekom doziranja deterdženta, omekšivača ili dodataka.

Program	I	II	
Pamuk	<input type="radio"/>	<input checked="" type="radio"/>	<input type="radio"/>
Sintetika	<input type="radio"/>	<input checked="" type="radio"/>	<input type="radio"/>
Mješovito	<input type="radio"/>	<input checked="" type="radio"/>	<input type="radio"/>
Traper	<input type="radio"/>	<input checked="" type="radio"/>	<input type="radio"/>
Sport	<input type="radio"/>	<input checked="" type="radio"/>	<input type="radio"/>
Čišćenje bubnja			
20°C		<input checked="" type="radio"/>	<input type="radio"/>
Parno pranje	<input type="radio"/>	<input checked="" type="radio"/>	<input type="radio"/>
Centrifugiranje			
Ispiranje i centrifugiranje			<input type="radio"/>
Vuna		<input checked="" type="radio"/>	<input type="radio"/>
Dječja odjeća	<input type="radio"/>	<input checked="" type="radio"/>	<input type="radio"/>
Brzo 15'		<input checked="" type="radio"/>	<input type="radio"/>
ECO 40-60		<input checked="" type="radio"/>	<input type="radio"/>
Brzo 45'		<input checked="" type="radio"/>	<input type="radio"/>

Obvezatno

Po želji (opcija)

Uporaba deterdženta

Preporuka za uporabu deterdženta za pranje	Ciklus pranja (program)	Temp. pranja	Vrsta rublja ili tekstila
Snažni deterdženti sa sredstvima za izbjeljivanje	Pamuk, Mješovito	20°C 40°C 60°C	Rublje od bijele pamučne ili lanene tkanine otporne na visoke temperature pranja
Color deterdženti (za pranje obojenih tkanina), bez sredstva za izbjeljivanje	Pamuk, Mješovito	Hladno 20°C 40°C	Obojeno (šareno) rublje od pamučne ili lanene tkanine
Color ili blagi deterdženti bez sredstva za izbjeljivanje	Sintetika	Hladno 20°C 40°C	Obojeno (šareno) rublje od sintetike ili tkanina koje se lako održavaju
Blagi deterdženti za pranje	Sintetika	20°C 40°C	Osjetljive tkanine, svila, viskoza
Specijalni deterdženti za pranje vune	Vuna	20°C 40°C	Vuna

NAPOMENE!

Ako se koriste granulasti ili vrlo gusti i ljepljivi deterdženti ili aditivi, prije njihovog stavljanja u odjeljak, potrebno ih je razrijediti s vodom kako bi se spriječilo začepeljivanje izlaza iz odjeljka a time i preljevanje vode iz ladice kada aparat uzima vodu.

Potrebno je odabrati odgovarajući deterdžent za odgovarajuću temperaturu pranja kako bi se postigle najbolje performanse pranja uz manju potrošnju energije i vode.

Kako bi se ostvarila najbolja čistoća rublja, važno je odgovarajuće doziranje deterdženta.

Potrebno je smanjiti količinu deterdženta ako bubanj nije potpuno napunjen. Neophodno je podesiti količinu deterdženta prema tvrdoći vode (ako je voda iz vodovoda meka, tada treba manje deterdženta).

Doziranje deterdženta ovisi o nivou zaprljanosti, jer manje zaprljano rublje zahtjeva manju količinu deterdženta.

Visoko koncentrirani (kompaktni) deterdženti zahtjevaju pažljivo i točno doziranje.

Pojava jakog pjenjenja i loši rezultati pranja i ispiranja, posljedice su prevelike količine deterdženta.

Ako je oprano rublje sivo ili ako se pojavljuje gomilanje ostataka (mucica) na bubnju, grijačem elementu i rublju, to je posljedica premalene količine deterdženta.

Upravljački elementi i njihova uporaba

NAPOMENA!

Crteži i skice samo su informativne naravi i može se razlikovati od stvarnog izgleda na aparatu.

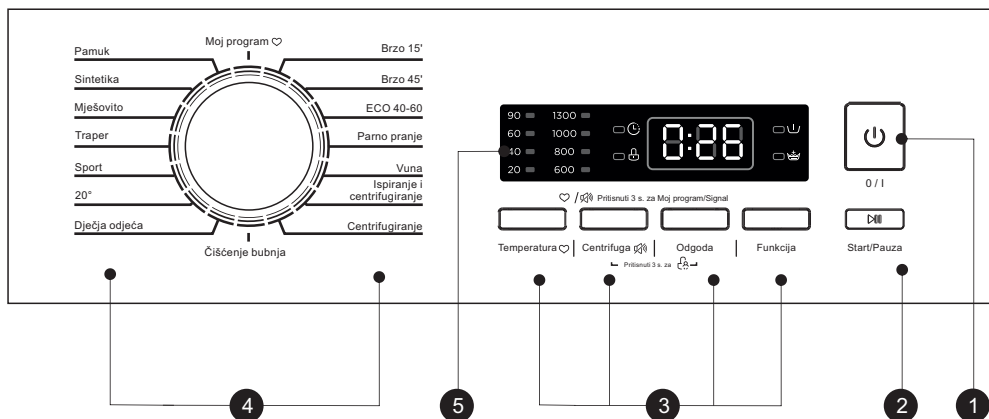

1 0 / I

Tipka za uključenje/isključenje aparata.

2 Start/Pauza

Tipka za pokretanje ili pauziranje ciklusa pranja.

3 Dodaci

Tipka za odabir dodatnih funkcija (uključiti se lampica na pokazivaču).

4 Programi

Držak za odabir raznih programa prema vrsti rublja.

5 Display

Display (pokazivač) pokazuje postavke, funkcije, procijenjeno preostalo vrijeme te statusne poruke na aparatu. Display će svjetliti tijekom ciklusa pranja/sušenja.

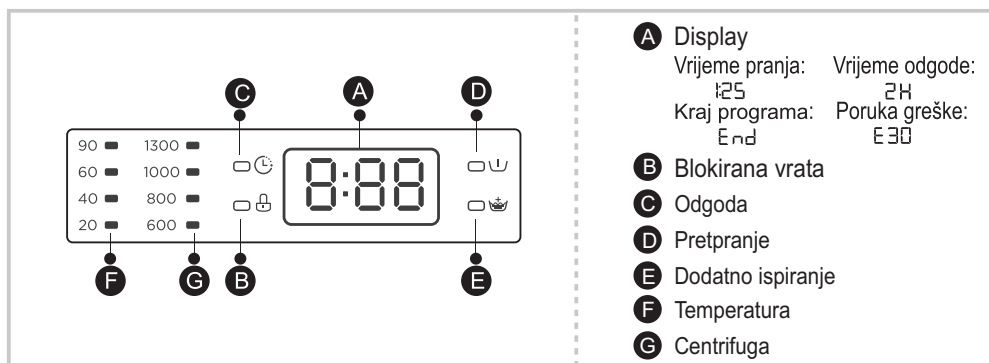

Program	Kapacitet (kg)	Vrijeme trajanja (hh:mm)
Pamuk	8.0	2:40
Sintetika	4.0	2:20
Mješovito	8.0	1:20
Traper	8.0	1:40
Sport	4.0	0:47
20°C	4.0	1:01
Dječja odjeća	8.0	2:01
Čišćenje bubnja	-	1:18
Centrifugiranje	8.0	0:12
Ispiranje i centrifugiranje	8.0	0:20
Vuna	2.0	1:07
Parno pranje	4.0	1:47
ECO 40-60	8.0	3:38
Brzo 45'	2.0	0:45
Brzo 15'	2.0	0:15

Napomena !

Podaci u tablicama samo su informativne naravi. Stvarni parametri mogu odstupati od parametara prikazanih u tablicama. Vrijednosti trajanja programa, potrošnje energije i vode mogu se razlikovati u ovisnosti od opterećenja i vrste rublja, odabranih dodatnih funkcija, tipa vode, odabranog deterdženta i temperature okoliša. Stvarni parametri ovise o tome kako će se aparat koristiti. Tablice uzeti samo kao približni orijentir.

Program	Kapacitet (kg)	Temperatura (°C)	Vrijeme trajanja (h:min)	Potrošnja energije (kW/ciklus)	Potrošnja vode (litara/ciklus)	Najviša temperatura (°C) (1)	Preostala vlaga (%brzina centrifuge) (2)
Brzo 15'	2.0	Hladno	0:15	0.026	34	Hladno	53/800
20°C	4.0	20	1:01	0,183	47	20	70/800
Pamuk	8.0	60	2:45	1,394	71	60	53/1300
Sintetika	4.0	40	2:20	0,625	34	40	35/800
Mješovito	8.0	40	1:20	0.754	4	40	70/800
ECO 40-60 (3)	8.0	-	3:38	0,739	71	38	53.9/1250
	4.0	-	2:48	0,456	47	32	53.9/1250
	2.0	-	2:48	0,196	38	23	53.9/1250

Vrijednosti za programe različite od "ECO 40-60" jesu samo za informaciju.

Program 20°C može prati samo lagano zaprljano pamučno rublje, pri nominalnoj temperaturi od 20°C, a što je u skladu s regulativom (EU) 2019/2023.

U skladu s Regulativama EN 60456:2016/prA2019 sa (EU)2019/2014, (EU)2019/2023, (EU)2021/340, (EU)2021/341

EU energetska učinkovitost: A

Program za testiranje: ECO 40-60. Ostale postavke su osnovne.

Polu punjenja za 8.0kg aparat iznosi 4.0kg.

Četvrtina punjenja za 8.0kg aparat iznosi 2.0kg.

- 1) Najviša postignuta temperatura rublja u ciklusu pranja koje traje najmanje 5 min.
- 2) Preostala vlaga nakon ciklusa pranja u vodi, sadrži postotak i broj okretaja centrifuge pri kojoj je ta vrijednost doegnuta.
- 3) Program ECO40-60 omogućuje pranje normalno zaprljanog pamučnog rublja, koje je perivo od 40°C ili 60°C, zajedno u istom ciklusu. Ovaj se program koristi unutar regulative (EU) 2019/2023.

Programi sa najvećom učinkovitosti glede potrošnje energije jesu općenito oni koji se izvode duže vremena pri nižim temperaturama.

Punjenje rubljem, perilice rublja za kućanstvo, na kapacitet koji odgovara odgovarajućem programu doprinosi uštedi energije i vode.

Razina buke i preostala vlaga su ovisne o brzini vrtnje centrifuge. Veća brzina vrtnje rezultira većom razinom buke, ali manjom preostalom vlagom.

































POZORNOST !

U slučaju nestanka električne energije tijekom rada aparata, zadnje postavke programa su memorirane, pa nakon povratka električne energije, program nastavlja s radom.

Tablica programa

Programi koji su dostupni prema vrsti rublja kao i modelu parata.

Programi	
Pamuk	Pamučne i lanene tkanine otporne na više temperature.
Sintetika	Pranje rublja od sintetičkih tkanina. Majice, jakne, miješano. Tijekom pranja pletenih tkanina potrebno je smanjiti količinu deterdženta zbog slabije konstitucije vlakana i jačeg stvaranja pjene.
Dječja odjeća	Pranje dječje odjeće, što ju čini puno čišćom, a ispiranje je poboljšano kako bi se zaštitila osjetljiva dječja koža.
Brzo 45'	Brzo pranje nekoliko komada odjeće, koja nije jako zaprljana.
Mješovito	Zajedničko pranje odjeće od pamučnih i sintetičkih tkanina.
Sport	Pranje odjeće namjenjene za sport i aktivnosti.
Traper	Specijalno za pranje odjeće od trapera (jeans-a).
Brzo 15'	Kratak program za brzo pranje odjeće. Prikladno za lagano zaprljano rublje kao i za malu količinu rublja.
Vuna	Pranje vunениh tkanina za ručno ili strojno pranje, kao i od tkanina s većim sadržajem vune. Vrlo nježan program pranja kojim se sprječava skupljanje, duže su pauze u programu (pa su tkanine duže u vodi).
Centrifugiranje	Samo centrifugiranje s odabranom brzinom vrtnje.
Ispiranje i centrifugiranje	Dodatno ispiranje i centrifugiranje.
Čišćenje bubnja	Posebni program za čišćenje bubnja i cijevi. Program podiže temperaturu na 90°C kako bi sterilizirao unutrašnje površine te kako bi pranje rublja, nakon toga, bilo više ekološki čisto. Pri uporabi ovog programa ne stavlja se rublje ili deterdžent. Program se koristi uobičajeno ili prema potrebi.
ECO 40-60	Osnovna temperatura od 40°C ne može se podešavati, prikladno za pranje rublja na 40°C - 60°C.
Parno pranje	Dodaje se para u ciklusu pranja, dublje prodire u vlakna čime se eliminiraju klice i bakterije, te sprječavaju neugodni mirisi.
20°C	Osnovna temperatura od 20°C. Pranje u hladnoj vodi.

Program	Osnovna temperatura (°C)	Osnovna brzina centrifuge (okr/min)	Dodatne funkcije
Pamuk	40	800	 ,  , 
Sintetika	40	800	 ,  , 
Mješovito	40	800	 ,  , 
Traper	40	800	 ,  , 
Sport	20	800	 ,  , 
20°C	20	800	 , 
Dječja odjeća	60	800	 ,  , 
Čišćenje bubnja	90	--	
Centrifugiranje	--	800	
Ispiranje i centrifugiranje	--	800	 , 
Vuna	40	600	 , 
Parno pranje	40	800	 ,  , 
ECO 40-60	--	--	
Brzo 45'	20	800	 , 
Brzo 15'	Hladno	800	

 Dodatno ispiranje

 Pretpranje

 Odgoda

Napomena !

Za maksimalne brzine vrtnje, trajanje programa te ostale detalje oko programa "ECO 40-60" i "Pranje i Sušenje", potrebno je konzultirati informacijski list.

Tablica prikazuje koje su funkcije moguće na kojem programu.

Dodaci (funkcije)



Temperatura

Pritiskanjem tipke odabire se temperatura:
Hladno (cold), 20°C , 30°C , 40°C , 60°C , 90°C



Centrifuga

Pritiskanjem tipke odabire se brzina centrifuge:
0 , 600 , 800 , 1000 , 1300 o/min



Odgoda

Podešavanje funkcije odgode:

1. Odabrati program
2. Pritisnuti tipku "Odgoda" kako bi se odabralo vrijeme (0-24 sata)
3. Pritisnuti tipku "Start/Pauza" za potvrdu funkcije



Odabrati
program



Podesiti vrijeme
odgode



Start

Poništenje funkcije odgode:

Pritisnuti tipku "Odgoda", prije nego što se program pokrene, dok se na displayu ne pojavi 0H. Ako je već program u tijeku, tada je potrebno isključiti aparat kako bi se program poništio, pa ponovno odabrati novi program.

POZORNOST !

U slučaju nestanka električne energije tijekom rada aparata, zadnje postavke programa su memorirane, pa nakon povratka električne energije, program nastavlja s radom.



Pretpranje

Pretpranje je funkcija koja omogućuje dodatno pranje rublja prije početka glavnog programa pranja, a pogodna je za pranje prašnjavog i jako prljavog rublja. Potrebno je umetnuti deterdžent u odjeljak "I".



Dodatno ispiranje

Funkcija kojom se rublje podvrgava dodatnom ispiranju.



Isključenje zvučnog signala



Odabrati program

Pritisnuti tipku "Centrifuga"
u trajanju od 3 sekunde, čime se izvučni signal isključuje.

Za uključenje zvučnog signala pritisnuti tipku i držati 3 sekunde.
Postavke će biti zapamćene do sljedećeg reseta.

Pozornost!

Nakon isključenja zvučne funkcije, zvukovi se neće moći aktivirati.



Roditeljsko zaključavanje (zaštita za djecu)

Aparat posjeduje posebnu funkciju za sigurnost djece, a kojim se onemogućuju nehotični pritisci na tipke.



Centr.

Odgoda



Pritisnuti tipke "Centrifuga" i "Odgoda" na 3 sec. dok se ne javi zvučni signal, te se upali indikator za roditeljsku zaštitu.

Odabrali
program

Start

Pozornost!

Roditeljsko zaključavanje blokira sve tipke osim "0/I" i "Roditeljsko zaključavanje". Pritiskom obje tipke ("Centrifuga" i "Odgoda") na 3 sekunde, funkcija se poništava. Roditeljsko zaključavanje se mora deaktivirati prije izbora novog programa.



Moj Program

Ova funkcija definira i memorira Vaš omiljen program koji često koristite. Nakon odabira programa i dodatka, pritisnite i držite tipku "Temperatura" oko 3 sekunde, prije nego započne pranje, a Vaš će program biti snimljen (memoriran). Tvornički je postavljen program "Pamuk".

ODRŽAVANJE APARATA

Čišćenje i održavanje

⚠ Pozornost!

Prije početka održavanja, potrebno je isključiti aparat iz električne mreže te zatvoriti dovod vode.

Čišćenje kućišta aparata

Odgovarajuće održavanje aparata može produžiti radni vijek aparata. Površine se mogu čistiti krpom umočenom u mješavinu vode i tekućeg deterdženta. Deterdžent mora biti neutralan i ne smije biti abrazivan. Ako se uoči procurivanje vode po površini tada je treba odmah obrisati krpom. Nije dozvoljena uporaba oštih i šiljatih predmeta u svrhu čišćenja.

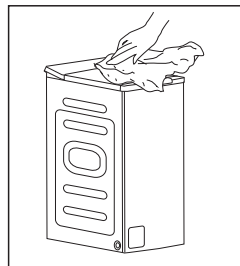

Napomena !

Uporaba kemijskih ili sličnih sredstava (alkohol, kemijska sredstva, otapala, kiseline, ili slično) nije dozvoljeno u svrhu čišćenja.

Čišćenje bubnja

Preostala hrđa unutar bubnja, koja je preostala od metalnih predmeta, mora odmah biti uklonjena pomoću deterdženata koji ne sadrže klor. Uporaba metalne vune nije dozvoljeno u svrhu čišćenja.

Napomena !

Ne stavljati rublje u aparat tijekom čišćenja bubnja.

Čišćenje filtra za ulaz vode

Napomena !

Ulazni filtar se mora očistiti ako je dotok vode u aparat smanjen.

1. Zatvoriti pipu za vodu.

Odspojiti crijevo za ulaz vode.

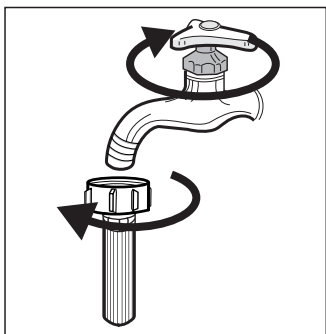

2. Očistiti filtar pomoću četkice i vode.

Ponovno spojiti crijevo na pipu.

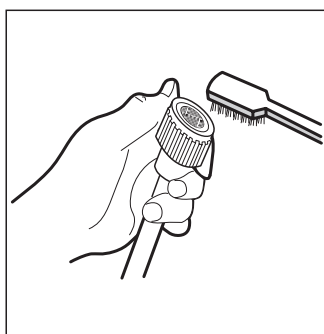

3. Odvrnuti ulazni fitting sa crijevom na stražnjoj strani aparata.

Izvući filtar pomoću odgovarajućeg alata (kliješta s dugačkim vrhom).

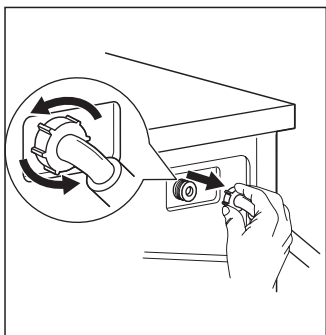

4. Očistiti filtar pomoću četkice i vode.

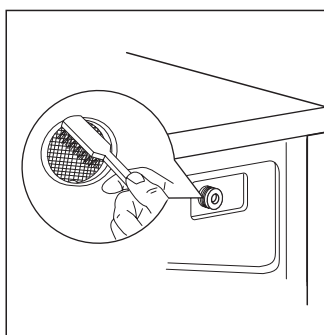

5. Ponovo pričvrstiti fitting za dovod vode na stražnjoj strani aparata, te zavrnuti crijevo za ulaz vode natrag na pipu.

6. Preporučuje se čišćenje ulaznog filtera svaka 3 mjeseca, čime se osigurava normalan rad aparata.

Čišćenje ladice za deterdžent

1. Pritisnuti prema dolje poziciju A, na pokrovu za omekšivač, koji se nalazi unutar ladice.
2. Podići kopču prema gore i izvaditi pokrov omekšivača te isprati sve vodom, a naročito žljebove.
3. Vratiti pokrov za omekšivač te gurnuti ladicu na mjesto.

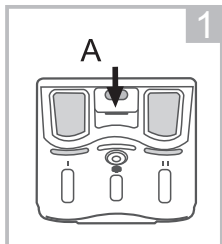

Pritiskom na poziciju "A" izvući ladicu van



Oprati ladicu ispod mlaza tekuće vode

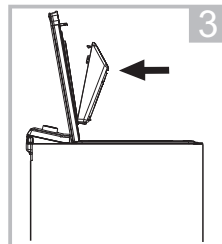

Vratiti ladicu natrag u aparat

Napomena !

Uporaba abrazivnih te kemijskih ili sličnih sredstava (alkohol, kemijska sredstva, otapala, kiseline, ili slično) nije dozvoljeno u svrhu čišćenja.

Čišćenje ladice za deterdžent se preporučuje svaka 3 mjeseca.

Čišćenje filtra na pumpi za odvod vode

⚠ Pozornost!

Nije dozvoljeno otvaranje poklopca s filtrom tijekom rada aparata. Obratiti pozornost na vruću vodu koja može preostati nakon pranja. Zbog toga je potrebno pričekati kako bi se smjesa otpadne vode i deterdženta ohladila. Prije početka čišćenja, potrebno je isključiti aparat iz električne mreže (opasnost od električnog udara) te zatvoriti dovod vode. Uvjerite se kako je poklopac dobro pritegnut i siguran. Filtar treba redovito čistiti (svaka 3 mjeseca) kako bi se osigurao normalan rad aparata.

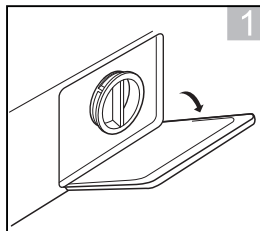

1 Otvoriti vratašca za pristup filtru

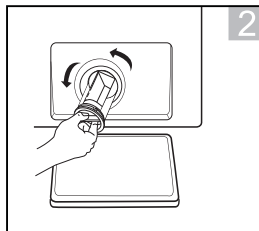

2 Otvoriti poklopac s filtrom okretanjem obrnuto od smjera kazaljke na satu

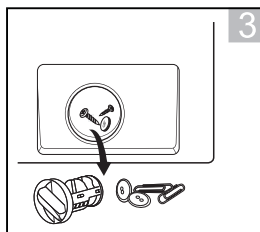

3 Izbaciti strane objekte i ostatke

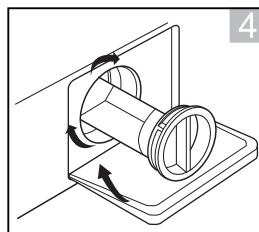

4 Vratiti filtara na mjesto i zatvoriti ga, te zatvoriti vratašca za pristup

Problemi te njihovo moguće uklanjanje

POZORNOST!

Samo stručno osposobljeno servisno osoblje, iz ovlaštenog servisa, smije obavljati popravke.



Ukoliko Vaš aparat ne radi ispravno, uzrok bi mogla biti neka sitnica.

Kolebanja u električnoj mreži:

Ponekad se događaju velike promjene napona u mreži ili čak vrlo brzi i kratki prekidi napona u mreži (dijelić sekunde ili do sekundu-dvije). Ta pojava može uzrokovati prekid rada elektronike u aparatu. U tom slučaju isključite aparat iz mreže, pričekajte nekoliko minuta, uključite aparat te ponovo pokrenite program.

Neki aparati memoriraju zadnje stanje prilikom izvršavanja programa, pa povratak električne energije samo nastavi rad programa gdje je stao.

Kako biste uštedijeli vrijeme i novac prije pozivanja servisera, provjerite sljedeće:

Opis	Razlog	Moguće rješenje
Aparat se ne može startati	Vrata aparata nisu zatvorena	Zatvoriti vrata i ponovo startati aparat Provjeriti da li se zaglavila odjeća
Vrata aparata se ne mogu otvoriti	Sigurnosna brava na vratima je uključena	Isključiti aparat sa električne mreže te ponovno startati aparat
Curenje vode	Priključak dovoda vode ili ispusta vode nije stegnut	Provjeriti i pritegnuti priključak na vodu Očistiti crijevo za ispušt vode
Ostaci deterdženta u ladicu	deterdžent je vlažan ili u grudicama	Očistiti, oprati i obrisati ladicu za deterdžent
Signalno svjetlo ili display ne svijetli	Prekid u napajanju upravljačke ploče ili spojeva	Provjeriti da li je došlo do prekida u električnoj mreži te da li je priključak pravilno priključen na električnu mrežu
Prevelika buka		Provjeriti da li su transportne blokade uklonjene Provjeriti da li je aparat postavljen na čvrstu i ravnu podlogu te niveliran

Kodovi greške

Kod greške	Razlog	Moguće rješenje
<i>E30</i>	Vrata aparata nisu propisno zatvorena	Zatvoriti vrata i ponovo startati program Provjeriti da li se zaglavila odjeća
<i>E10</i>	Problemi s ubrizgavanjem vode tijekom pranja	Provjeriti da li je tlak vode prenizak Provjeriti da li je crijevo za ulaz vode presavijeno, prignječeno ili blokirano Provjeriti da li je filter za ulaz vode začepljen
<i>E21</i>	Predugo pražnjenje vode	Provjeriti da li je crijevo za izlaz vode blokirano
<i>E12</i>	Procurivanje vode	Ponovo startati aparat
<i>EXX</i>	Ostalo	Pokušati ponovo startati aparat, a ako se greška i dalje pojavljuje tada pozvati ovlašteni servis.

Ukoliko predložena rješenja ne uklone problem, ili se pojavi drugačija signalizacija greške, tada isključite aparat na tipku "O / I", izvadite utikač iz utičnice, zatvorite dovod vode te pozovite ovlašteni servis.

Informacije o prijevozu

Prije transporta, aparat treba pripremiti - isprazniti vodu iz bubnja, očistiti aparat, staviti blokade i ostalo.

Ako je moguće, sačuvajte originalnu ambalažu i proizvod uvijek prevozite u originalnoj ambalaži. Pridržavajte se znakova i uputa za prijevoz na kutiji.

Ako nemate originalnu kutiju tada poduzmite potrebne mjere za zaštitu vanjskih površina (staklenih, plastičnih i obojenih površina) aparata od udaraca.

Nakon transporta, aparat se mora ponovno postaviti i priključiti u skladu s uputama.

Tehnički podaci

Model	PRT138MDINVG
Standardni tlak vode	0.1MPa~1MPa
MAX. struja	10A
Napon	220-240V~ 50Hz
Kapacitet pranja	8.0kg
Dimenzije(Š*D*V)	400*610*875mm
Težina	56kg
Nazivna snaga	1900W

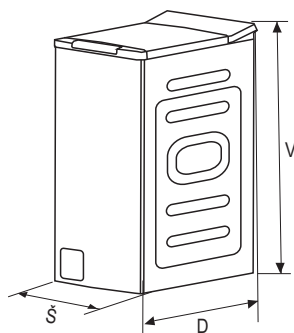

Informacijski list proizvoda

Delegirana uredba Komisije (EU) 2019/2014 u pogledu označivanja energetske učinkovitosti kućanskih perilica rublja i kućanskih perilica-sušilica rublja

Ime ili zaštitni znak dobavljača: KONČAR

Adresa dobavljača: KONČAR - KUĆANSKI APARATI d.d., Slavenska avenija 16, 10001 Zagreb, Hrvatska

Identifikacijska oznaka modela: PRT138MDINVG

Glavni parametri proizvoda:

Parametar	Vrijednost		Parametar	Vrijednost	
Nazivni kapacitet ^(a) (kg)	8.0		Dimenzije u centimetrima	Visina	88
				Širina	40
				Dubina	61
Indeks energetske učinkovitosti EEL _W ^(a)	51.9		Razred energetske učinkovitosti ^(a)	A	
Indeks učinkovitosti pranja ^(a)	1.031		Učinkovitost ispiranja ^(a) (g/kg)	5.0	
Potrošnja energije u kWh po ciklusu, na temelju programa eco 40-60. Stvarna potrošnja energije ovisit će tome kako se uređaj koristi.	0.472		Potrošnja vode u litrama po ciklusu, na temelju programa eco 40-60. Stvarna potrošnja vode ovisit će o tome kako se uređaj koristi i o tvrdoći vode.	48	
Najviša temperatura u obrađenom tekstilu ^(a) (°C)	Nazivni kapacitet	38	Preostali sadržaj vlage ^(a) (%)	Nazivni kapacitet	53.9
	Polovina	32		Polovina	53.9
	Četvrtina	23		Četvrtina	53.9
Brzina centrifugiranja ^(a) (okr./min)	Nazivni kapacitet	1250	Razred učinkovitosti centrifugiranja ^(a)	B	
	Polovina	1250			
	Četvrtina	1250			
Trajanje programa ^(a) (h:min)	Nazivni kapacitet	3:38	Vrsta	samostojeći	
	Polovina	2:48			
	Četvrtina	2:48			
Emisija buke koja se prenosi zrakom u fazi centrifugiranja ^(a) (dB(A) re 1 pW)	78		Razred emisije buke koja se prenosi zrakom ^(a) (faza centrifugiranja)	C	
Isključeno stanje (W)	0.50		Stanje pripravnosti (W)	-	
Odgodeni početak rada (W) (ako je primjenjivo)	4.00		Umreženi odgodeni početak rada (W) (ako je primjenjivo)	-	

Minimalno trajanje jamstva koje nudi proizvođač: 60 mjeseci

Ovaj je proizvod projektiran za ispuštanje iona srebra tijekom ciklusa pranja:

NE

Dodatne informacije:

Poveznica na internetsku stranicu proizvođača: www.koncar-ka.hr

(a) za program eco 40 – 60.

Washing Machine

OWNER'S MANUAL

Read This Manual 

Read all instructions and explanations for the installation before use. Follow the instructions carefully. Keep the operation instructions handy for later use. If the appliance is sold or passed on, ensure that the new owner always receives this operation instructions.

CONTENTS

SAFETY INSTRUCTIONS

- Safety Instructions 2

INSTALLATION

- Product Description 9
- Installation 10

OPERATION

- Quick Start 13
- Before Each Washing 15
- Detergent Dispenser 16
- Control Panel 18
- Programmes.....19
- Option..... 23

MAINTENANCE

- Cleaning and Care 26
- Trouble Shooting 29
- Customer Service..... 30
- Technical Specifications 30
- Product Fiche 31

SAFETY INSTRUCTIONS

■ Safety Instructions

Please read the following safety information thoroughly and follow it strictly to minimize the risk of fire or explosion, electric shock and to prevent property damage, personal injury or loss of life. Failing to follow these instructions shall void any warranty.

Warning!

This combination of symbol and signal word indicates a potentially dangerous situation which may result in death or serious injuries unless it's avoided.

Caution!

This combination of symbol and signal word indicates a potentially dangerous situation which may result in slight or minor injuries or damage to property and the environment.

Note!

This combination of symbol and signal word indicates a potentially dangerous situation which may result in slight or minor injuries.

Warning!

ELECTRIC SHOCK HAZARD

- If the supply cord is damaged, it must be replaced by the manufacturer, its service agent or similarly qualified persons in order to avoid a hazard.
 - If the machine is damaged, it must not be operated unless repaired by the manufacturer, its service agent or similarly qualified persons.
- Risk of electric shock!

SAFETY INSTRUCTIONS

- The appliance can be used by children aged from 8 years and above and persons with reduced physical, sensory or mental capabilities or lack of experience and knowledge if they have been given supervision or instruction concerning use of the appliance in a safe way and understand the hazards involved. Children shall not play with the appliance. Cleaning and user maintenance shall not be made by children without supervision.
- Children should be supervised that they do not play with the appliance.
- Children 3 years and under shall be kept away from the appliance or continuously supervised.
- Animals and children may climb into the machine. Check the machine before every operation.
- Do not climb or sit on the appliance.

INSTALLATION LOCATION AND SURROUNDING

- All washing and additional substances are to be kept in a safe place out of the reach of children.
- Do not install the machine on a carpet floor. The obstruction of the openings by a carpet can damage the machine.
- Keep the appliance clear from heating sources and direct sunlight to avoid plastic and rubber parts to corrode.
- Do not use the appliance in humid environments or rooms containing explosive or caustic gas. In case of water leakage or water splashes let the appliance dry in the open air.
- The appliance must not be installed behind a lockable door, a sliding door or a door with a hinge on the opposite side to that of the washing machine.

SAFETY INSTRUCTIONS

- Do not operate the machine in rooms with a temperature of below 5°C. This can cause damages to parts of it. If it is unavoidable, make sure to drain the water completely from the appliance after every use (see „Maintenance - Cleaning of drain pump filter“) to avoid damages caused by frost.
- Never use flammable sprays or substances in the immediate proximity of the appliance.

INSTALLATION

- Remove all packaging material and transport bolts before using the appliance. Otherwise, serious damage may result.
- This appliance is equipped with a single inlet valve and can be connected to the cold water supply only.
- Mains plug must be accessible after installation.
- Before washing clothes for the first time, the product shall be operated once throughout all the procedures without any clothes inside.
- Do not put any excessively heavy objects on the appliance, like water containers or heating devices.
- The new hose-sets supplied with the appliance are to be used and that old hose-sets should not be reused.
- Max. Inlet water pressure 1 MPa. Min. inlet water pressure 0.1 MPa.

ELECTRICAL CONNECTION

- Make sure the supply cable is not trapped by the machine, it can get damaged.
- Connect the product to a grounded outlet protected by a fuse complying with the values in the “ Technical specifications “ table. The grounding installation has to be made by a qualified electrician. Ensure that the machine is installed in accordance with the local regulations.

SAFETY INSTRUCTIONS

•Water and electrical connections must be carried out by a qualified technician in accordance with the manufacturer's instructions and local safety regulations.

Warning!

- Don't use multiple plugs or extension cords.
- The appliance must not have an external switching device such as a timer or connected to a circuit that is regularly switched on and off.
- Do not pull the plug out of the mains outlet if there is flammable gas around.
- Never pull out power plug with wet hands.
- Always pull at the plug, not at the cable.
- Always unplug the appliance if it is not being used.

WATER CONNECTIONS

- Check the connections of the water inlet tubes, the water tap and the outlet hose for possible problems due to changes of water pressure. If the connections loosen or leak close the water tap and get it repaired. Do not use the appliance before the pipes and hoses are installed properly by qualified persons.
- Glass door may become very hot during the operation. Keep children and pets far away from the machine while it is operating.
- The water inlet and outlet hoses have to be safely installed and remain undamaged. Otherwise, water leakage can occur.
- Do not remove the drain pump filter while there is still water in the appliance. Big quantities of water can leak out, and there is a risk of scalding due to hot water.

SAFETY INSTRUCTIONS

OPERATION AND MAINTENANCE

- Never use any flammable, explosive or toxic solvents. Do not use gasoline and alcohol etc. as detergents. Only select detergents that are suitable for machine washing.
- Make sure that all pockets are emptied. Sharp and rigid items such as coins, brooches, nails, screws, stones etc. may cause serious damages to this machine.
- Remove all objects from pockets such as lighters and matches before use the appliance.
- Thoroughly rinse items that have been washed by hand.
- Items that have been soiled with substances such as cooking oil, acetone, alcohol, petrol, kerosene, spot removers, turpentine, wax and wax removers should be washed in hot with an extra amount of detergent before being dried in the appliance.
- Items containing foam rubber (latex foam), shower caps, water proof textiles, rubber backed articles and clothes or pillows fitted with foam rubber pads should not be dried in the machine
- Fabric softeners or similar products should be used as recommended in their instructions.
- Never try to open the door forcefully. The door will unlock shortly after the end of a cycle.
- Please do not close the door with excessive force. If it is found difficult to close the door, please check if the clothes are properly inserted and distributed.

SAFETY INSTRUCTIONS

- Always unplug the appliance and close the water tap before cleaning and maintenance and after each use.
- Never pour water over the appliance for cleaning purpose. Risk of electric shock!
- Repairs shall only be carried out by the manufacturer, its service agent or similarly qualified persons in order to avoid a hazard. The producer will not be responsible for damages caused by the intervention of not authorized persons.

TRANSPORT

- Before Transport:
 - Bolts shall be reinstalled to the machine by a specialized person
 - Accumulated water shall be drained out of the machine
- This appliance is heavy. Transport with care. Never hold any protruding part of the machine when lifting. The machine door cannot be used as a handle.

INTENDED USE

The product is intended only for home use and for textiles in household amounts suitable for machine washing and drying. This appliance is for indoor use only and not intended for built in use. Only use according to these instructions. The appliance is not intended for commercial use.

Any other use is considered as improper use. The producer is not responsible for any damage or injuries that may result of it.

- This appliance is intended to be used in household and similar applications such as:
 - Staff kitchen areas in shops, offices and other working environments;
 - Farm houses;
 - By clients in hotels, motels and other residential type environments;
 - Bed and breakfast type environments;
 - Areas for communal use in blocks of flats or in launderettes.

SAFETY INSTRUCTIONS

Packaging/Old appliance



This marking indicates that this product should not be disposed with other household wastes throughout the EU. To prevent possible harm to the environment or human health from uncontrolled waste disposal, recycle it responsibly to promote the sustainable reuse of material resources. To return your used device, please use the collection systems or contact the retailer where the product was purchased. They return and can take this product for environmental safe recycling.

INSTALLATION

■ Product Description

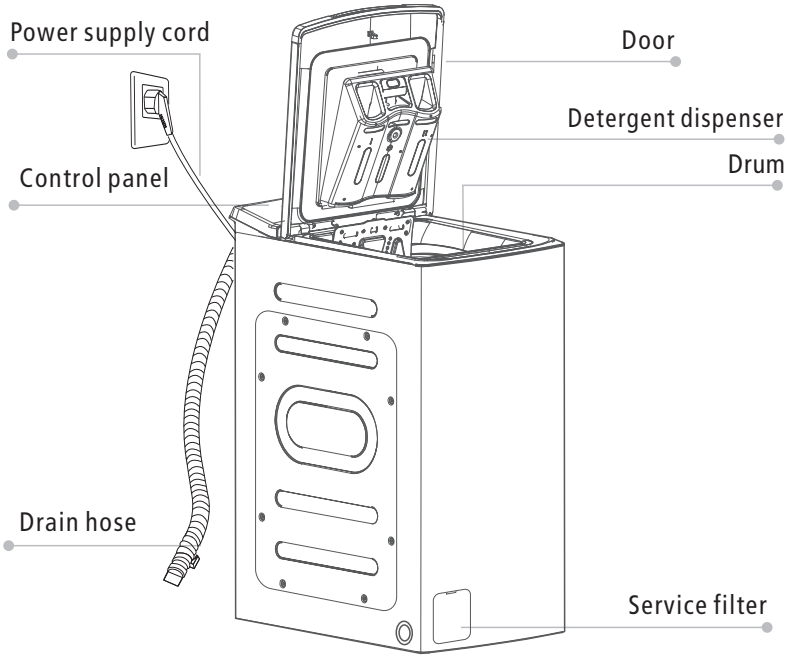

Note!

- The product line chart is for reference only, please refer to real product as standard.

Accessories

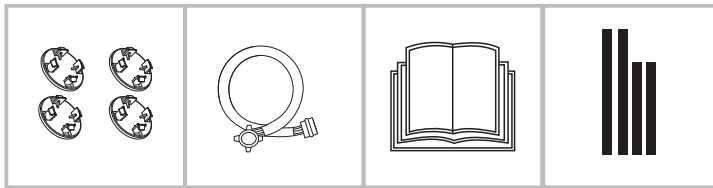

Transport hole plug

Supply hose cold water

Owner's manual

Acoustic sponge (Optional)

INSTALLATION

■ Installation

Installation area

⚠ Warning!

- Stability is important to prevent the product from wandering!
- Make sure that the product should not stand on the power cord.

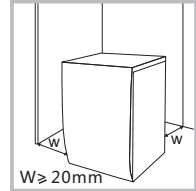

Before installing the machine, the location characterized as follows shall be selected:

1. Rigid, dry, and level surface
2. Avoid direct sunlight
3. Sufficient ventilation
4. Room temperature is above 0°C
5. Keep far away from the heat resources such as coal or gas.

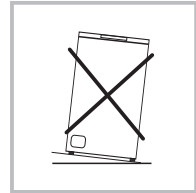

Unpacking the washing machine

⚠ Warning!

- Packaging material (e.g. Films, Styrofoam) can be dangerous for children.
- There is a risk of suffocation ! Keep all packaging well away from children.

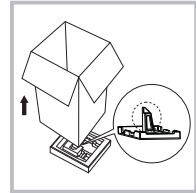

1. Remove the cardboard box and styrofoam packing.
2. Lift the washing machine and remove the base packing. Make sure the small triangle foam is removed with the bottom one together. If not, lay the unit down with side surface, then remove the small foam from the unit bottom manually.
3. Remove the tape securing the power supply cord and drain hose.
4. Remove the inlet hose from the drum.

Remove transport bolts

⚠ Warning!

- You must remove the transport bolts from the backside before using the product.
- You'll need the transport bolts again if you move the product, so make sure you keep them in a safe place.

Please take the following steps to remove the bolts:

1. Loosen 4 bolts with spanner and then remove them.
2. Stop the holes with transport hole plugs.
3. Keep the transport bolts properly for future use.

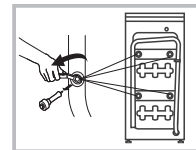

INSTALLATION

Remove transport bolts

⚠ Warning!

- You must remove the transport bolts from the backside before using the product.



Loosen the 4 transport bolts with a spanner.

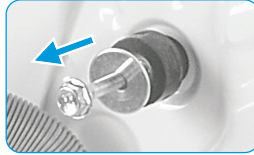

Remove the bolts including the rubber parts and keep them for future use.

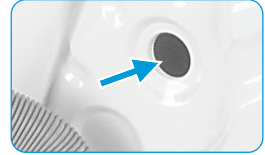

Close the holes using the cover caps.

Levelling the washing machine

⚠ Warning!

- The lock nuts on all four feet must be screwed tightly against the housing.

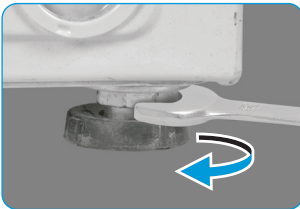

1. Loosen the lock nut.
2. Turn the foot until it reaches the floor.
3. Adjust the legs and lock the nuts with a spanner. Make sure the machine is level and steady.

Connect the water supply hose

⚠ Warning!

To prevent leakage or water damage, follow the instructions in this chapter

- Do not kink, crush or modify water inlet hose.



Connect the water supply hose to the water inlet valve and a water tap with cold water as indicated.



🔧 Note!

- Connect manually, do not use tools. Check if the connections are tight.

INSTALLATION

Drain Hose

⚠ Warning!

- Do not kink or protract the drain hose.
- Position drain hose properly ,otherwise damage might result of water leakage.

There are two ways to place the end of drain hose:

1.Put it into the water trough.

2.Connect it to the branch drain pipe of the trough.

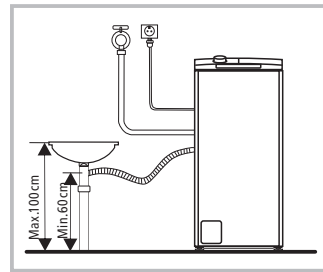
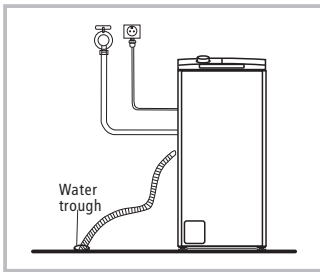

📌 Note!

- If the machine has drain hose support, please install it like the following .

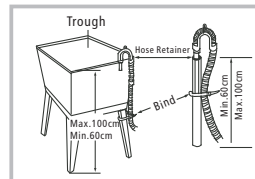
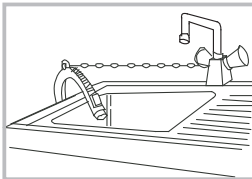

⚠ Warning!

- When installing drain hose, fix it properly with a rope.
- If drain hose is too long, do not force it into washing machine as it will cause abnormal noises.

OPERATION

■ Quick Start

⚠ Caution!

- Before washing, please make sure the washing machine is installed properly.
- Your appliance was thoroughly checked before it left the factory. To remove any residual water and to neutralize potential odors, it's recommended to clean your appliance before first use. For this reason, start the Drum Clean without laundry and detergent.

1. Before Washing

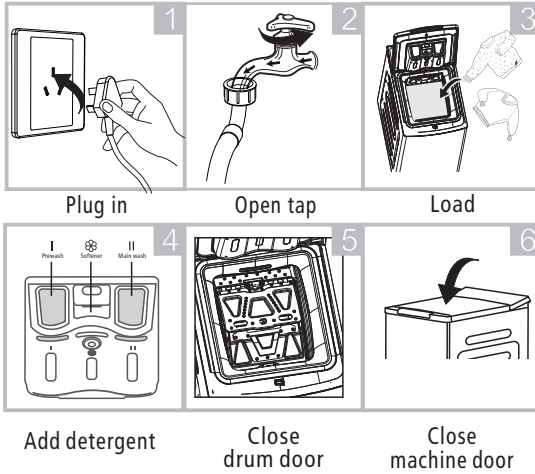

📌 Note!

- Detergent need to be added in "case I" after selecting pre-washing for machines with this function.
- Make sure that the drum flaps are properly locked.

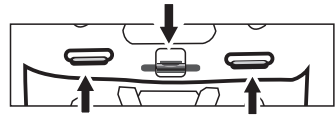

- All metal hooks must be properly hooked inside the rear door flap.

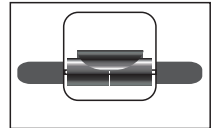

- Check the roller before each laundry, it must roll smoothly.

2. Washing

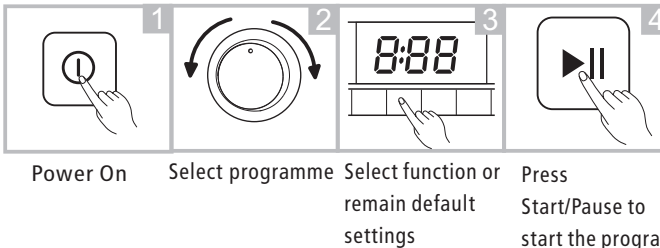

📌 Note!

- Step 3 is optional.

3. After Washing

All lights off.

INSTALLATION

Acoustic Sponge

Note!

- Please make sure to assemble the acoustic sponges, which can effectively reduce the noise caused by the machine while working, in order to provide you with a more peaceful and quiet living environment.

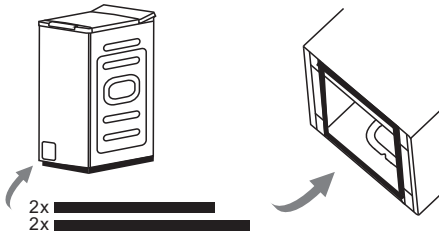

1. Get the machine laid on the floor, using some soft material like foam or clothes between the machine and floor for a protection;
2. Stick the 2x longer sponges to the longer bottom edges of machine, and the 2x shorter sponges to the shorter bottom edges.

OPERATION

■ Before Each Washing

- The ambient temperature of the washing machine should be 5-40°C. If used under 0°C, the inlet valve and draining system may be damaged. If the machine is installed under freezing conditions, it should be transferred to normal ambient temperature to ensure the water supply hose and drain hose can unfreeze before use.
- Please check your laundry care labels and the detergent use instructions before wash. Use non-foaming or less-foaming detergent suitable for machine washing properly.

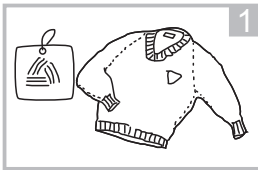

Check the care label

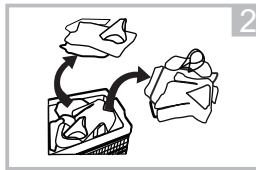

Sort laundry according to color and textile type

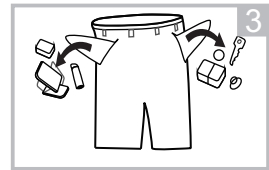

Take all items out of the pockets

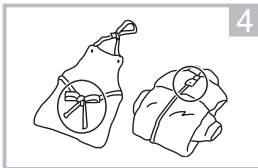

Tie together long textile strips and belts, close zips and button

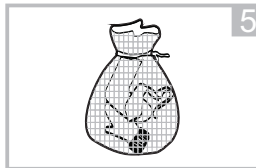

Put small items into a laundry bag

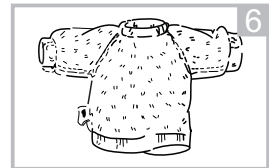

Turn easy-pilling and long-pile fabric inside out

⚠ Warning!

- Do not wash articles that have been cleaned in, washed in, soaked in, or dabbed with combustible or explosive substances like wax, oil, paint, gasoline, alcohol, kerosene, and other flammable materials.
- Washing single clothes items may easily create big eccentricity and cause alarm due to unbalance. Therefore it is suggested to add one or two more laundry items to the wash so that spin can be done smoothly.
- Do not wash, or spin water-proof seats, mats, or clothing.

OPERATION

Detergent Dispenser

- I Pre Wash detergent
- II Main Wash detergent
- ☼ Softener

⚠ Caution!

- Detergent only need to be added in "case I" after selecting pre-washing for machines with this function.
- Do not exceed the "MAX" level mark when filling in detergent, additives or softener.

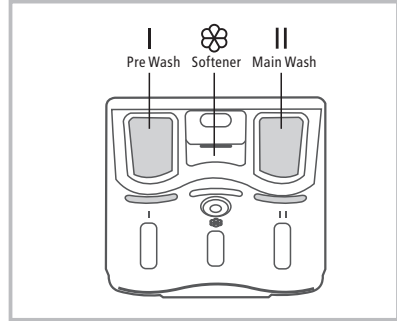

Pull out the dispenser

Programme	I	II	☼	Programme	I	II	☼
Cotton	○	●	○	Spin Only			
Synthetic	○	●	○	Rinse & Spin			○
Mix	○	●	○	Wool		●	○
Jeans	○	●	○	Baby Care	○	●	○
Sportswear	○	●	○	Quick 15'		●	○
Drum Clean				ECO 40-60		●	○
20°C		●	○	Rapid 45'		●	○
Steam	○	●	○				

● Means must ○ Means optional

OPERATION

Detergent Recommendation

Recommended washing detergent	Wash cycles	Washing temp.	Type of laundry and textile
Heavy-duty detergent with bleaching agents and optical brighteners	Cotton,Mix	20/ 40/60	White laundry made from boil-proof cotton or linen
Colour detergent without bleaching agent and optical brighteners	Cotton,Mix	Cold/20/ 40	Coloured laundry made from cotton or linen
Color or mild detergent without optical brighteners	Synthetic	Cold/20/ 40	Coloured laundry made from easy care fibres or synthetic materials
Mild washing detergent	Synthetic	20/40	Delicate textiles, silk, viscose
Special wool detergent	Wool	20/40	Wool

Note!

- Agglomerating or ropy detergent or additive can be diluted in some water before pouring it into the detergent dispenser, to avoid its inlet to get blocked and thus cause a water overflow.
- Please choose the suitable type of detergent to get a maximum of washing performance and a minimum of water and energy consumption
- To achieve the best cleaning result a proper detergent dosing is important.
- Use a reduced detergent amount if the drum is not filled completely.
- Always adjust the amount of detergent to the water hardness, if your tap water is soft, use less detergent.
- Dose according to how dirty your laundry is, less dirty clothes require less detergent.
- Highly concentrated (compact detergent) requires particularly accurate dosing.

Following symptoms are a sign of detergent overdosing:

- heavy foam formation
- poor washing and rinsing result

Following symptoms are a sign of detergent underdosing:

- laundry turns grey
- built-up of limescale deposits on the drum, the heating element and/or the laundry

OPERATION

Control Panel

Model: MFE80-T1312B/F02E-EU(NA)

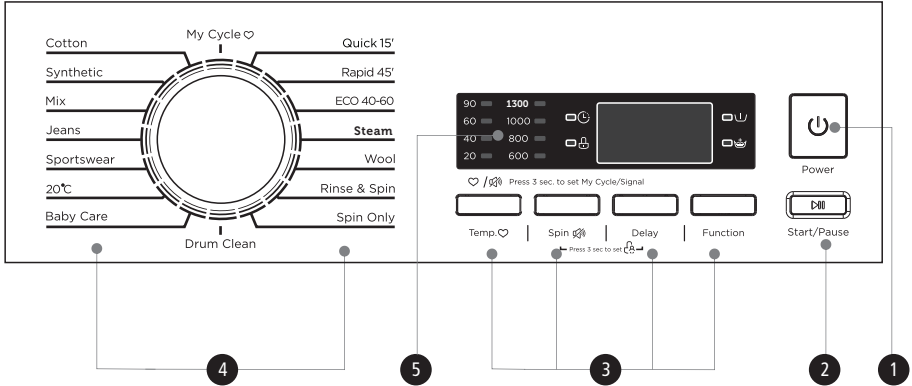

1 Power

Product is on/off.

2 Start/Pause

Press the button to start or pause the washing cycle.

3 Option

This allows you to select an additional function.

4 Programmes

Available according to the laundry type.

5 Display

The display shows the settings, estimated time remaining, options, and status messages for your washer. The display will remain on through the cycle.

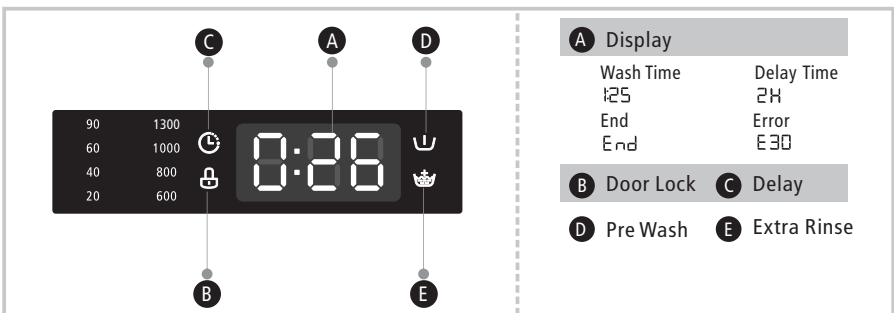

OPERATION

■ Programmes

Programme	Load(kg)	Display Time
	8.0	
Cotton	8.0	2:40
Synthetic	4.0	2:20
Mix	8.0	1:20
Jeans	8.0	1:40
Sportswear	4.0	0:47
20°C	4.0	1:01
Baby Care	8.0	2:01
Drum Clean	-	1:18
Spin Only	8.0	0:12
Rinse & Spin	8.0	0:20
Wool	2.0	1:07
Steam	4.0	1:47
ECO 40-60	8.0	3:38
Rapid 45'	2.0	0:45
Quick 15'	2.0	0:15



Note!

- The parameters in this table are only for user's reference. The actual parameters maybe different with the parameters in above mentioned table.

OPERATION

■ Programmes

Cycle	Nominal capacity in kg	Temperature setting	Cycle duration in hours and minutes	Energy consumption in kWh/operalling cycle	Water consumption in liter/operalling cycle	Highest temperature °C ¹⁾	residual moisture in % /spin speed ²⁾
Quick15'	2.0	cold	0:15	0.026	34	cold	53%/800
20°C	4.0	20	1:01	0.183	47	20	70%/800
Cotton	8.0	60	2:45	1.394	71	60	53%/1300
Synthetic	4.0	40	2:20	0.625	34	40	35%/800
Mix	8.0	40	1:20	0.754	44	40	70%/800
ECO 40-60 ³⁾	8.0	--	3:38	0.739	71	38	53.9%/1250
	4.0	--	2:48	0.456	47	32	53.9%/1250
	2.0	--	2:48	0.196	38	23	53.9%/1250

- The above data is for reference only, and the data may change due to different actual use conditions.
- The valves given for programmes other than the ECO 40-60 programme are indicative only.
- Concerning to EN 60456:2016/prA2019 With (EU)2019/2014, (EU)2019/2023, The EU energy efficiency class is: A
Energy test program: ECO 40-60. Other as the default.
Half load for 8.0kg machine:4.0kg.
Quarter load for 8.0kg machine:2.0kg.

OPERATION

- 1) The highest temperature reached by the laundry in the wash cycle for at least 5 minutes.
- 2) Residual moisture after the wash cycle in water content percent and the spin speed at which this was achieved.
- 3) The ECO 40-60 programme is able to clean normally soiled cotton laundry declared to be washable at 40°C or 60°C, together in the same cycle. This programme is used to assess the compliance with the regulation (EU) 2019/2023.

The most efficient programmes in terms of energy consumption are generally those that perform at lower temperatures and longer duration.

Loading the household washer up to the capacity indicated for the respective programmes will contribute to energy and water savings.

Noise and remaining moisture content are influenced by the spinning speed: the higher the spinning speed in the spinning phase, the higher the noise and the lower the remaining moisture content.

Caution!

- If there is any break in the power supply while the machine is operating, a special memory stores the selected programme. The machine will continue the programme when the power supply is re-established.

OPERATION

■ Programmes

Programmes are available according to the laundry type.

Programmes	
Cotton	Hard-wearing textiles, heat-resistant textiles made of cotton or linen.
Synthetic	Wash synthetic articles, for example: shirts, coats, blending. While washing the knitting textiles, detergent quantity shall be reduced due to its loose string construction and easily forming bubbles.
Baby Care	Washing the baby's clothes, it can make the baby's wear cleaner and make the rinse performance better to protect the baby skin.
Rapid 45'	Washing few and not very dirty clothes quickly.
Mix	Mixed load consisting of textiles made of cotton and synthetics.
Sportswear	Washing the activewear.
Jeans	Specially for jeans.
Quick 15'	Extra short programme approx, suitable for lightly soiled washing as a small amounts of laundry.
Wool	Hand or machine-washable wool or richwool textiles. Especially gentle wash programme to prevent shrinkage, longer programme pauses (textiles rest in wash liquor).
Spin Only	Spins and drains the water.
Rinse&Spin	Rinses and then spins the laundry, and then drains the water.
Drum Clean	Specially set in this machine to clean the drum and tube. It applies 90 °C high temperature sterilization to make the clothes washing more green. When this programme is performed, the clothes or other washing cannot be added. When proper amount of chlorine bleaching agent is put in, the barrel cleaning effect will be better. The customer can use this programme regularly according to the need.
ECO 40-60	Able to clean normally soiled cotton laundry declared to be washable at 40 °C or 60 °C, together in the same cycle.
Steam	The Steam Wash can deeply penetrate the fiber, which effectively eliminate bacterias and germs, preventing odors and protecting health.
20°C	Able to clean lightly soiled cotton laundry, at a nominal temperature of 20 °C.

OPERATION

■ Option

Cycle	Default Temp.(°C)	Default spin speed in rpm	Additional functions
Wash cycles		1300	
Cotton	40	800	⌚, 👑, ⌵
Synthetic	40	800	⌚, 👑, ⌵
Mix	40	800	⌚, 👑, ⌵
Jeans	40	800	⌚, 👑, ⌵
Sportswear	20	800	⌚, 👑, ⌵
20°C	20	800	⌚, 👑
Baby Care	60	800	⌚, 👑, ⌵
Drum Clean	90	--	⌚
Spin Only	--	800	⌚
Rinse & Spin	--	800	⌚, 👑
Wool	40	600	⌚, 👑
Steam	40	800	⌚, 👑, ⌵
ECO 40-60	--	--	⌚
Rapid 45'	20	800	⌚, 👑
Quick 15'	Cold	800	⌚

📌 Note!

- For the maximum spin speed, program time, and other details of the ECO 40-60 program, please refer to the content on the Product Fiche page.
- The table shows which cycle offers which options for adjustment. If an adjustment is not possible for a cycle.

OPERATION



Pre Wash

The Prewash function can get an extra wash before main wash, it is suitable for washing the dust rises to surface of the clothes; You need to put detergent into the Case (I) when select it.



Extra Rinse

The laundry will undergo extra rinse once after you select it.



Delay

Set the Delay function:

1. Select a programme; 2. Press the Delay button to choose the time 0-24H;
3. Press [Start/Pause] to commence the delay operation



Choose the Programme



Setting time



Start

Cancel the Delay function:

Press the [Delay] button until the display be 0H. It should be pressed before starting the programme. If the programme already started, should switch off programme to reset a new one.

⚠ Caution!

- If there is any break in the power supply while the machine is operating, a special memory stores the selected programme and when the power is restarted, the program will continue.
-



Temp.

Press the button to regulate the temperature (Cold, 20°C, 40°C, 60°C, 90°C)



Spin

Press the button to change the speed.

1300: 0-600-800-1000-1300

OPERATION



Child Lock

To avoid mis operation by children.



Choose the Programme



Start



Press [Spin] and [Delay]
3 sec. till buzzer beep.

! Caution!

- During the "Child Lock" function is activating, the buzzer will beep, When the buttons are pressed.
- Press the two button 3sec. also to be released the function.
- The "Child Lock" will lock all buttons except Power button.
- Cut off the power supply , the kid's protection is to be released.



Mute the buzzer



Choose the Programme



Press the [Spin] button for 3sec.,
the buzzer is mute.

To act the buzzer function, press the button again for 3 seconds. The setting will be kept until the next reset.

! Caution!

- After Muting the buzzer function, the sounds will not be activated any more.



My Cycle

To memory the frequently used programme.

After choosing the programme and setting the options, press [Temp.] 3 sec. before start to wash. The default setting course is Cotton.

! Note!

Usage counter

1. Unplug the equipment for 10s and reconnect again.
2. Power on and within 10s, please press "Temp." and "Function" on control panel simultaneously and continuously for around 5s until the device display shows digits--the value can indicate the times of equipment usage.
3. Repeat step 1 again and customer can resume to normal operation.

MAINTENANCE

■ Cleaning and Care

Warning!

- Before your maintenance starts, please unplug the machine and close the tap.

Cleaning The Cabinet

Proper maintenance on the washing machine can extend its working life. The surface can be cleaned with diluted non-abrasive neutral detergents when necessary. If there is any water overflow, use the wet cloth to wipe it off immediately. No sharp items are allowed.

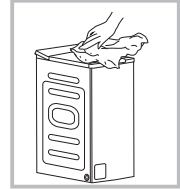

Note!

- Formic acid and its diluted solvents or equivalent are forbidden, such as alcohol, solvents or chemical products, etc.

Cleaning The Drum

The rusts left inside the drum by the metal articles shall be removed immediately with chlorine-free detergents. Never use steel wool.

Note!

- Don't put laundry in the washing machine during the drum cleaning.

MAINTENANCE

Cleaning the Inlet Filter

Note!

- Diminishing water flow is a sign that the filter need to be cleaned.

1. Close the tap and remove the water supply hose from it.
2. Clean the filter with a brush.
3. Unscrew the water supply hose from the backside of the machine. Pull out the filter with long nose pliers.
4. Use a brush to clean the filter.
5. Reinstall the filter to the water inlet and reconnect the water supply hose.
6. Clean the Inlet filter every 3 months to ensure the normal operation of the appliance.

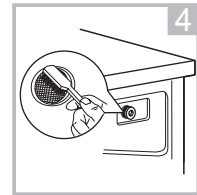
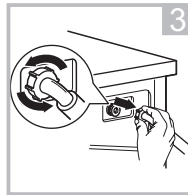
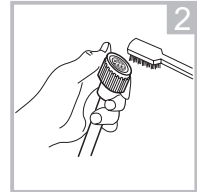
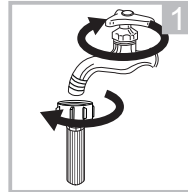

Clean The Detergent Dispenser

1. Press down the arrow location on softener cover inside the dispenser drawer.
2. Lift the clip up and take out softener cover and wash all grooves with water.
3. Restore the softener cover and push the drawer onto position.

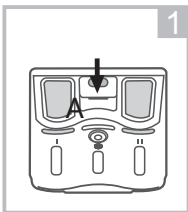

Pull out the dispenser drawer with press the A

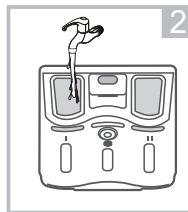

Clean the dispenser drawer under water

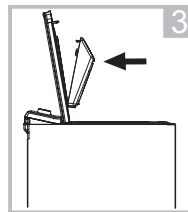

Insert the dispenser drawer

Note!

- Do not use abrasive or caustic agents to clean plastic parts.
- Clean the detergent dispenser every 3 months to ensure the normal operation of the appliance.

MAINTENANCE

Cleaning the Drain Pump Filter

Warning!

- Make sure that the machine has finished the washing cycle and is empty. Switch it off and unplug it before cleaning the drain pump filter.
- Be careful of hot water. Allow the water to cool down. Risk of scalding!
- Clean the filter periodically every 3 months to ensure the normal operation of the appliance.

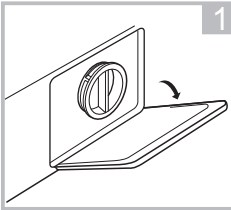

Open the lower cover cap

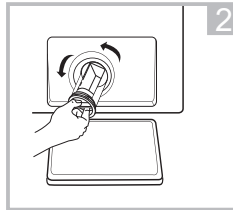

Open the filter by turning to the counter clockwise

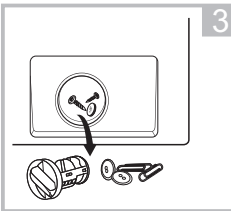

Remove extraneous matter

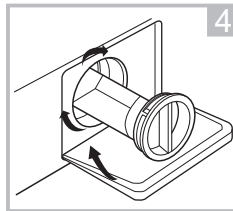

Close the lower cover cap

MAINTENANCE

■ Trouble Shooting

The start of the appliance does not work or it stops during operation. First try to find a solution to the problem, If not, contact the service centre.

Description	Reason	Solution
Washing machine cannot start up	Door is not closed properly	Restart after the door is closed Check if the clothes is stuck
Door can't be opened	Washer's safety protection design is working	Disconnect the power, restart the product
Water leakage	The connection between inlet pipe or outlet hose is not tight	Check and fasten water pipes Clean up outlet hose
Detergent residues in the box	Detergent is dampened or agglomerated	Clean and wipe the detergent box
Indicator or display does not light	Disconnect the power PC board or harness has connection problem	Check if the power is shut down and the power plug is connected correctly
Abnormal noise		Check if the fixing (bolts) have been removed Check it's installed on a solid and level floor

LED display models:

Description	Reason	Solution
E30	Door is not closed properly	Restart after the door is closed Check if the clothes is stuck
E10	Water injecting problem while washing	Check if the water pressure is too low Straighten the water pipe Check if the inlet valve filter is blocked
E21	Overtime water draining	Check if the drain hose is blocked
E12	Water overflow	Restart the washer
EXX	Others	Please try again first, call up service line if there are still troubles

Note!

- After the check, activate the appliance. If the problem occurs or the display shows other alarm codes again, contact the service.

MAINTENANCE

■ Customer Service

Spare part for your appliance are available for a minimum of 10 years.

In case of questions please contact our customer service at:

⚠ Warning!

Risk of electric shock

- Never try repair an appliance which is defective or presumed to be defective. You may put your own and future users' lives in danger. Only authorised specialists are allowed to carry out this repair work.
- Improper repair will void the warranty and subsequent damages can't be recognized!

Transport

IMPORTANT STEPS WHEN MOVING THE APPLIANCE

- Unplug the appliance and close the water inlet tap.
- Check, if the door and the detergent dispenser are closed properly.
- Remove the water inlet pipe and the outlet hose from the house installations.
- Let the water drain completely from the appliance (see "Maintenance Cleaning the drain pump filter")
- Important: Re-install the 4 transport bolts in the back of the appliance.
- This appliance is heavy. Transport with care. Never hold any protruding part of the machine when lifting. The machine door cannot be used as a handle.

■ Technical Specifications

Power Supply 220-240V~,50Hz

MAX.Current 10A

Standard Water Pressure 0.1MPa~1MPa

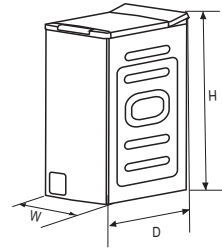

Model	Washing Capacity	Dimension (W*D*H:mm)	Net Weight	Rated Power
	8.0kg	400*610*875	56kg	1900W

MAINTENANCE

■ Product Fiche

Supplier's name or trade mark^(*)([†]):

Supplier's address^(*)([†]):

Model identifier^a

General product parameters:

Parameter	Value	Parameter	Value	
Rated capacity ^(b) (kg)	8.0	Dimensions in cm ^(b) , ([‡])	Height	88
			Width	40
			Depth	61
Energy efficiency index ^(b) (EEI _w)	51.9	Energy efficiency class ^(b)	A ^(d)	
Washing efficiency index ^(b)	1.031	Rinsing effectiveness (g/kg) ^(b)	5.0	
Energy consumption in kWh per cycle, based on the eco 40-60 programme. Actual energy consumption will depend on how the appliance is used.	0.472	Water consumption in litre per cycle, based on the eco 40-60 programme. Actual water consumption will depend on how the appliance is used and on the hardness of the water.	48	
Maximum temperature inside the treated textile ^(b) (°C)	Rated capacity	38	Weighted remaining moisture content ^(b) (%)	53.9
	Half	32		
	Quarter	23		
Spin speed ^(b) (rpm)	Rated capacity	1250	Spin-drying efficiency class ^(b)	B ^(d)
	Half	1250		
	Quarter	1250		
Programme duration ^(b) (h:min)	Rated capacity	3:38	Type	free-standing
	Half	2:48		
	Quarter	2:48		
Airborne acoustical noise emissions in the spinning phase ^(b) (dB(A) re 1 pW)	78	Airborne acoustical noise emission class ^(b) (spinning phase)	C ^(d)	
Off-mode (W) (if applicable)	0.50	Standby mode (W) (if applicable)	N/A	
Delay start (W) (if applicable)	4.00	Networked standby (W) (if applicable)	N/A	

Minimum duration of the guarantee offered by the supplier^(*)([†]):

This product has been designed to release silver ions during the washing cycle

NO

Additional information:

Weblink to the supplier's website, where the information in point 9 of Annex II to Commission Regulation (EU) 2019/2023⁽¹⁾ is found:

^(*) this item shall not be considered relevant for the purposes of Article 2(6) of Regulation (EU) 2017/1369.

^(b) for the eco 40-60 programme.

^(‡) changes to this item shall not be considered relevant for the purposes of paragraph 4 of Article 4 of Regulation (EU) 2017/1369.

^(d) if the product database automatically generates the definitive content of this cell, the supplier shall not enter these data.

MAINTENANCE

- 1) The actual energy consumption will depend on how the appliance is used.
- 2) The actual water consumption will depend on how the appliance is used and on the hardness of the water.
- 3) Delivery of the spare parts within 15 working days after having received the order.

Product Data Sheet concerning (EU) 2019/2014

The product data sheet for your appliance can be found online.

Go to <https://eprel.ec.europa.eu> and enter the model identifier for your appliance to download the data sheet.

The model identifier for your appliance can be found in the technical specifications section.

Ovaj dokument je originalno proizveden i objavljen od strane proizvođača, brenda Končar, i preuzet je sa njihove zvanične stranice. S obzirom na ovu činjenicu, Tehnoteka ističe da ne preuzima odgovornost za tačnost, celovitost ili pouzdanost informacija, podataka, mišljenja, saveta ili izjava sadržanih u ovom dokumentu.

Napominjemo da Tehnoteka nema ovlašćenje da izvrši bilo kakve izmene ili dopune na ovom dokumentu, stoga nismo odgovorni za eventualne greške, propuste ili netačnosti koje se mogu naći unutar njega. Tehnoteka ne odgovara za štetu nanесenu korisnicima pri upotrebi netačnih podataka. Ukoliko imate dodatna pitanja o proizvodu, ljubazno vas molimo da kontaktirate direktno proizvođača kako biste dobili sve detaljne informacije.

Za najnovije informacije o ceni, dostupnim akcijama i tehničkim karakteristikama proizvoda koji se pominje u ovom dokumentu, molimo posetite našu stranicu klikom na sledeći link:

<https://tehnoteka.rs/p/koncar-masina-za-pranje-vesa-prt138mdinvg-akcija-cena/>