

Uputstvo za upotrebu

KONČAR mašina za pranje veša PR149MG17INV

KONČAR



Tehnoteka je online destinacija za upoređivanje cena i karakteristika bele tehnike, potrošačke elektronike i IT uređaja kod trgovinskih lanaca i internet prodavnica u Srbiji. Naša stranica vam omogućava da istražite najnovije informacije, detaljne karakteristike i konkurentne cene proizvoda.

Posetite nas i uživajte u ekskluzivnom iskustvu pametne kupovine klikom na link:

<https://tehnoteka.rs/p/koncar-masina-za-pranje-vesa-pr149mg17inv-akcija-cena/>

K O N Č A R

HR

EN

UPUTE ZA UPORABU INSTRUCTION MANUAL

PERILICA RUBLJA WASHING MACHINE

PR127MG17INV
PR148MG17INV
PR149MG17INV
PR1410MG17INV

KONČAR - KUĆANSKI APARATI d.d.
Karlovačka ulica 23, 10451 Pisarovina, Hrvatska, EU
T: + (385) 1 2484 555 F: + (385) 1 2404 102
kucanski@koncar-ka.hr www.koncar-ka.hr



ŠTOVANI KUPCI,

zahvaljujemo Vam na povjerenju koje ste nam ukazali kupnjom našeg proizvoda.



Za Vaše lakše snalaženje prilikom uporabe aparata, pripremili smo ove Upute za uporabu.

Molimo Vas da pažljivo pročitate ove "Upute za uporabu" jer ćete na taj način izbjeći greške, povećati uporabno trajanje aparata, štedjeti energiju i novac.

Upute su dostupne na web adresi: **www.koncar-ka.hr**

Upute za uporabu odložite na sigurno mjesto kako bi ih mogli koristiti i za buduće potrebe. Ako aparat prodate ili ustupite drugom vlasniku tada uz aparat priložite i ove upute.



POZOR! VRUĆA POVRŠINA!



POZOR! OPASNOST OD POŽARA!

U uputama za uporabu mogu biti opisani različiti tipovi aparata koji se međusobno razlikuju po opremljenosti i načinu rada, te su zbog toga uključena i neka poglavlja, crteži i podaci koji za Vaš aparat ne dolaze u obzir.

Pridržavamo pravo izmjena i grešaka u uputama za uporabu.

Tehničke specifikacije i ovaj priručnik podložni su promjenama bez prethodne obavijesti ili najave.

SADRŽAJ

UVOD

- 3 Važne opće informacije
- 4 Informacije o jamstvu
- 5 Sigurnosna upozorenja

POSTAVLJANJE I PRIKLJUČENJE APARATA

- 13 Tehnički podaci
- 14 Opis proizvoda

UPORABA APARATA

- 15 Brze upute
- 17 Postavljanje i priključenje
- 20 Prije svakog pranja
- 21 Ladica za deterdžent
- 23 Upravljački elementi i njihova uporaba
- 24 Tablica programa i informacije
- 30 Dodaci

ODRŽAVANJE APARATA

- 33 Čišćenje i održavanje
- 37 Problemi te njihovo moguće uklanjanje
- 38 Informacije o prijevozu
- 38 Premještanje aparata

Važne opće informacije

Ovaj aparat je namijenjen isključivo za uporabu u domaćinstvu i sličnim okruženjima kao što su:

- priručne kuhinje za osoblje u trgovinama, uredima i drugim radnim okruženjima;
- korištenje od strane gostiju u hotelima, motelima i drugim smještajnim prostorima;
- gospodarske zgrade na farmama;
- objekti koji nude usluge noćenja s doručkom
- područja za komunalne uporabe u stambenim zgradama (zajedničke prostorije za pranje i sušenje rublja).

Aparat nije namijenjen uporabi u profesionalne (komercijalne) svrhe ili namjene koje nadilaze uobičajenu uporabu u domaćinstvu.

Ako se aparat ipak tako upotrebljava, tada proizvođač ne snosi nikakvu odgovornost, a jamstvo ne vrijedi.

Proizvođač ne snosi nikakvu odgovornost za ozljede ili oštećenja izazvana nepravilnim postavljanjem ili uporabom te ne priznaje pravo na jamstvo u slučaju nepridržavanja uputa za uporabu i nesavjesne uporabe aparata.

Proizvođač zadržava pravo promijeniti konstrukciju, mjere i težinu ako to smatra potrebnim radi poboljšanja kvalitete proizvoda, bez ugrožavanja osnovnih svojstava proizvoda i bez prethodne najave.

U uputama za uporabu mogu biti opisani različiti tipovi aparata koji se međusobno razlikuju po opremljenosti i načinu rada, te su zbog toga uključena i neka poglavlja, podaci i crteži koja za Vaš aparat ne dolaze u obzir.

ODLAGANJE PROIZVODA

Ovi proizvodi su razvijeni i proizvedeni uz uporabu kvalitetnih materijala i komponenti koje je moguće reciklirati i ponovo iskoristiti. Simbol s lijeve strane znači da se električni i elektronički aparati na kraju njihova uporabnog vijeka ne smiju odbacivati zajedno s ostalim kućnim otpadom.



Molimo da ovaj aparat predate lokalnoj tvrtki koja se bavi zbrinjavanjem otpada ili ga odnosi u reciklažno dvorište. Ovaj aparat zadovoljava EU direktivu (2012/19/EU) u svezi zbrinjavanja električnog i elektroničkog otpada (WEEE). Ovaj aparat zadovoljava EU RoHS direktivu (2011/65/EU).

Korisnik ne smije rastavljati aparat ili ostale komponente. Taj posao obavlja ovlaštena tvrtka koja se bavi recikliranjem takve vrste otpada.

Ambalaža je izrađena tako da ne ugrožava okoliš; ambalažni materijal je ekološki i može se preraditi, odnosno reciklirati. Nije dozvoljeno odlagati ambalažni materijal s ostalim kućnim otpadom, nego ga je poterbno odložiti na zato namjenenom mjestu.



Informacije o jamstvu

Ako do nekog kvara na aparatu dođe tijekom jamstvene dobi, nemojte ga popravljati sami.

Reklamaciju odmah prijavite na jedno od servisnih mjesta jer u suprotnom može doći do većeg oštećenja aparata, za što proizvođač neće preuzeti nikakvu odgovornost.

Pri podnošenju reklamacije držite se teksta

Jamstvenog Lista. Najnovije informacije o servisnim mjestima nalaze se na web stranici www.koncar-ka.hr

Bez predaje pravilno popunjenog Jamstvenog lista i priloženog računa za kupljeni aparat reklamacija je nevažeća.

SIGURNOSNA UPOZORENJA

NE RABITE APARAT PRIJE NEGO PROČITATE UPUTE ZA UPORABU I UPOZNATE SE S NJEGOVM UPORABOM.



Upute za uporabu odložite na sigurno mjesto kako bi ih mogli koristiti i za buduće potrebe. Ako aparat prodate ili ustupite drugom vlasniku tada uz aparat priložite i ove upute.

Zbog Vaše sigurnosti, morate se pridržavati naputaka u ovim uputama te na taj način smanjiti rizike od požara, eksplozija, elekričnog udara, oštećenja imovine, opasnosti po okoliš, ozljedama osoba s ozbiljnim ili tragičnim (smrtnim) posljedicama.

⚠ POZORNOST!

Ova kombinacija simbola i riječi označava potencijalno opasnu situaciju koja može rezultirati opasnim ozljedama osoba, oštećenjem imovine, opasnosti po okoliš, te tragične (smrtne) posljedice.

POZORNOST! Proizvođač/distributer ne preuzima nikakvu odgovornost za oštećenja nastala prilikom uporabe neuzemljenog aparata, te u svezi bilo kakvog oštećenja i povreda ako se ne pridržava uputa za uporabu, u slučaju nesavjesne i nepravilne uporabe aparata, samostalnih popravaka i modifikacija te uporabe dijelova koji nisu originalni i odobreni od proizvođača.

Ako do nekog kvara na aparatu dođe, nemojte ga popravljati sami, nego kvar odmah prijavite na jedno od servisnih mjesta, jer u suprotnom može doći do većeg oštećenja aparata.

Ovaj aparat je namijenjen isključivo za uporabu u domaćinstvu (i sličnim okruženjima) i unutar zatvorenih prostora, te nije namijenjen uporabi u profesionalne (komercijalne) svrhe ili namjene koje nadilaze uobičajenu uporabu u domaćinstvu.

Ako se aparat ipak tako upotrebljava, tada proizvođač ne snosi nikakvu odgovornost, a jamstvo ne vrijedi.

⚠ POZORNOST! SIGURNOST DJECE!

⚠ POZORNOST! Po primitku aparata, raspakirajte ga, ambalažni materijal (plastičnu foliju, stiropor, drvo...) uklonite izvan domašaja djece kako se djeca ne bi ozljedila (progutala manje komade ili se ugušila plastičnom folijom).

⚠ OPREZ! Ambalažni materijal (plastična folija, stiropor, drvo...) je opasan za djecu. Djeci nemojte dozvoliti igranje ambalažnim materijalom, kako ne bi progutala manje komade ili se ugušila plastičnom folijom.

⚠ POZORNOST! Ovaj aparat mogu upotrebljavati djeca u dobi od osam godina i starija te osobe sa smanjenim tjelesnim, osjetnim ili duševnim sposobnostima ili pomanjkanjem iskustva i znanja ako dobiju nadzor ili uputu o uporabi aparata na siguran način te razumiju uključene opasnosti.

⚠ POZORNOST! Djeci onemogućite penjanje na aparat ili ulaz u bubanj jer postoji opasnost sa tragičnim posljedicama.

⚠ POZORNOST! Omekšivače rublja, deterdžente i slične proizvode držite izvan dohvata djece.

⚠ POZORNOST! Ne ostavljajte djecu bez stalnog nadzora u blizini aparata.

⚠ POZORNOST! Djeca ne smiju koristiti aparat za igru.

⚠ POZORNOST! Čišćenje i korisničko održavanje ne smiju obavljati djeca bez nadzora. Isto vrijedi i za maloljetne osobe.

Ovaj aparat nije namijenjen osobama (uključujući djecu mlađu od 3 godine) koje imaju smanjene fizičke, osjetne ili mentalne sposobnosti, kao i osobama koje nisu dovoljno iskusne i informirane, osim ako ih se nadgleda ili ako su dobile upute o uporabi aparata od osobe odgovorne za njihovu sigurnost.

Kućni ljubimci moraju biti pod stalnim nadzorom te im se mora onemogućiti penjanje po aparatu, zavlčenje u isti, kao i griženje kablova. Prije uporabe aparata obavite provjeru!

Nije dozvoljeno penjanje niti sjedenje na aparatu.

⚠ POZORNOST! OPASNOST OD OPEKLINA!

Površina vrata, stakla, cijev za odvod vode te dijelovi aparata mogu biti jako vrući tijekom rada pa stoga može doći do opekline. Zbog toga djeca i kućni ljubimci moraju biti udaljeni od aparata te pod stalnim nadzorom.

**⚠ POZORNOST!
OPASNOST OD ELEKTRIČNOG UDARA!**

Električna sigurnost aparata zajamčena je jedino ako je ono ispravno spojeno na ispravnu i propisnu električnu instalaciju s uzemljenjem.

Aparat obvezatno mora biti uzemljen!

Budite uvjereni kako priključni vod nije oštećen, prignječen ili zapetljan tijekom instalacije, ne zatežite priključni vod.

Ne uključujte aparat u električnu instalaciju ako je priključni vod oštećen.

Oštećeni priključni vod mora biti zamijenjen ispravnim, a smije ga zamijeniti jedino stručna osoba ili serviser.

Nestručno priključenje i popravci mogu uzrokovati električni udar i tjelesne ozljede.

Aparat se priključuje na propisno instaliranu zidnu priključnicu s kontaktom za uzemljenje s vlastitim strujnim krugom i osiguračem. Zidna priključnica mora biti uzemljena, lako pristupačna, ne smije biti izložena toplinskom zračenju i vlazi.

Priključnica i instalacija mora izdržati struju koja je uvijek veća od one potrebne za aparat.

Aparat nije dozvoljeno priključiti na električnu instalaciju preko produžnih kablova i/ili vanjskih timera ili sličnih uređaja i daljinskih kontrolera.

Ne dodirujte aparat mokrim rukama dok je uključen u električnu instalaciju te nemojte biti bos i dok se služite aparatom.

Nakon uporabe aparata, obvezatno ga odspojite od električne mreže (povlačeći utikač iz utičnice, ali samo suhim rukama) te zatvorite dovod vode.

⚠ POZORNOST! OPASNOST OD EKSPLOZIJE!

Aparat se ne smije koristiti u prostorijama gdje se pojavljuju zapaljive i/ili eksplozivne pare ili kemikalije.

Ne smije se prati ili sušiti rublje koje je čišćeno, namočeno, prano ili trljano zapaljivim ili eksplozivnim sredstvima koja su ostala na rublju (kao što su trikloretilen, benzin, aceton, vosak, ulje, odmašćivači, petrolej, itd.) jer bi moglo doći do požara ili eksplozije.

Ispušni zrak iz aparata ne smije biti usmjeren u kuhinjsku napu ili na odvod zraka koji koriste kućanski aparati na plin ili druga goriva.

**Aparat se ne smije koristiti ako se industrijske kemikalije koriste za čišćenje rublja.
Nije dozvoljeno držati zapaljive tvari u blizini ili na aparatu jer bi se mogle zapaliti.**

POZORNOST U SVEZI S POSTAVLJANJEM APARATA

Priključak za vodu i struju mora biti izveden prema nacionalnim propisima i sigurnosnim odredbama, te od strane ovlaštenog, stručnog i kvalificiranog osoblja.

Potrebno je ukloniti sve transportne blokade prije uporabe aparata jer može doći do ozbiljnih oštećenja.

Aparat je namjenjen samo za unutarnju uporabu.

Aparat nije ugradbeni, niti je predviđen za ugradnju u elemente.

Aparat ne smije biti instaliran iza prepreka (npr vrata, klizna vrata i sl.) jer se time onemogućuje potpuno otvaranje vrata na aparatu.

Aparat se ne smije postaviti u prostorijama koje su zaparene, vrlo vlažne (npr. kupaona) ili gdje se pojavljuju zapaljive, eksplozivne ili korozivne pare.

Aparat se ne smije postavljati na tepih ili podne obloge kako se ne bi zaklonili ili zatvorili otvori na aparatu.

Opasnost od smrzavanja! Ne postavljajte aparat u prostorijama gdje može doći do smrzavanja ili na temperaturama blizu nule. Pri tome može doći do smrzavanja vode u pumpi, crijevima, bubnju, itd.

Aparat ne koristite pri temperaturama nižim od 5°C.

Priključci aparata (voda, odvod, struja) moraju biti dostupni nakon postavljanja.

Za priključak na vodu potrebno je koristiti novo crijevo koje je isporučeno uz aparat, a ne staro ili prije upotrebljavano crijevo. Crijevo se priključuje samo na hladnu vodu tlaka od min. 0,05 MPa do max. 1 MPa.

Crijeva za priključak na vodu i odvod moraju biti dobro pričvršćena i osigurana, te neoštećena, inače bi moglo doći do procurivanja vode.

POZORNOST U SVEZI NEPRAVILNE UPORABE

Aparat je namjenjen samo za uporabu u kućanstvu te za pranje-sušenje tekstila koji je prikladan za strojno pranje-sušenje.

Nije dozvoljeno penjati se, sjediti ili stavljati teške predmete na gornju ploču aparata.

Nije dozvoljeno naslanjati se na vrata aparata.

Ne izlažite aparat sunčevom zračenju.

Aparat se ne smije pomicati tijekom rada ili održavanja.

Ne vadite utičnicu iz utikača potezanjem priključnog voda. Nemojte presavijati ni oštećivati priključni vod, te ga nemjote uključivati - isključivati mokrim rukama.

Nemojte deinstalirati i instalirati aparat bez uputa ili nadzora.

Nije dozvoljeno prati tepihe.

Ne čistite aparat mlazom vode ili visokotlačnim parnim aparatom za čišćenje.

Ne stavljajte u perilicu više rublja od preporučenog.

Držite se maksimalnog dozvoljenog kapaciteta.

Nemojte zatvarati vrata prejakom silom. Ako se vrata teško zatvaraju, potrebno je provjeriti da li odjeća spriječava zatvaranje ili je uklještena u šarnir vrata.

POZORNOST U SVEZI UPORABE APARATA

Prije uprabe aparata preporučuje se kalibracija istoga, kako bi bolje radio (ako je ta opcija ugrađena).

Ako se aparat koristi po prvi put, potrebno je izvršiti jedan ciklus pranja bez odjeće.

Rabite samo odgovarajuće deterdžente i omekšivače koji su namjenjeni za strojno pranje rublja, a u skladu s uputama proizvođača dotičnih sredstava.

Zabranjeno je korištenje zapaljivih, eksplozivnih i štetnih otapala (benzin, alkohol, itd) umjesto deterdženta.

Provjerite da u džepovima odjeće, koju stavljate u aparat, nema kakvih predmeta (upaljači, mobiteli, igle, novčići, šibice, vijci, itd.) jer bi mogli oštetiti aparat.

Provjerite da li je voda u bubnju ispražnjena prije otvaranja vrata. Ako je voda u bubnju tada nije dozvoljeno otvaranje vrata.

Obratite pozornost i ne dodirujte odvodno crijevo tijekom pražnjenja vruće vode jer bi se mogli opeći.

Ne otvarajte filter pumpe ako je voda u aparatu jer može isteći velika količina, a voda može biti i vruća pa postoji opasnost od opekline.

Ne pokušavajte otvarati vrata na silu. Nakon završetka programa potrebno je pričekati do dvije minute kako bi se mogla otvoriti vrata.

Nije dozvoljeno ručno nadopunjavanje vode tijekom pranja.

Prostorija u kojoj se nalazi aparat mora se dobro provjetravati kako bi se spriječio povratni tok plinova koje ispuštaju aparati koji izgaraju plin i ostale energente (npr. peći, štednjaci i sl.).

Aparati čija se vrata mogu otvoriti tijekom pražnjenja vode, potrebno je pričekati oko 15 sekundi dok se ne završi proces pražnjenja vode.

Rublje koji sadrže lateks i gumene dijelove, kape za kupanje i tuširanje, rublje od vodonepropusnih tkanina, rublje, jastuci ili prevlake s spužvastom gumom, zabranjeno je sušiti u aparatu.

Rublje koje je bilo natopljeno zapaljivim ili kemijskim sredstvima (ulje, alkohol, benzin, aceton, vosak, ulje, odstranjivači mrlja, terpentini, petroleji) mora biti suho pa onda oprano u vrućoj vodi s više deterdženta, a tek se onda može sušiti u aparatu.

Nije dozvoljeno sušenje neopranog rublja.

Završni dio ciklusa pranja-sušenja izvršava se bez topline (ciklus hlađenja) kako bi rublje ostalo na temperaturi koja ga neće oštetiti (za perilice-sušilice).

POZOR! Nikada ne zaustavljajte aparat prije kraja programa, a ako se to mora tada rublje treba brzo izvaditi i rasprostrjeti kako bi se ohladilo. Rublje u bubnju je vruće i potreban je oprez prilikom vađenja jer može doći do opekline.

Nakon završetka programa i uporabe, potrebno je isključiti aparat, izvaditi utičnicu priključnog kabela iz električnog priključka te zatvoriti dovod vode.

Prije svakog čišćenja i održavanja, aparat obvezatno isključite iz električne mreže povlačeći utikač iz utičnice, ali samo suhim rukama!

POZORNOST U SVEZI POPLAVE

Poduzmite odgovarajuće mjere za sprječavanje proklizavanja cijevi na umivaoniku, jer snaga vode koja prolazi kroz cijev, koja nije postavljena na odgovarajući način, može pomaknuti cijev. Cijev mora biti učvršćena. Postavite čep umivaonika tako da ne zatvara odvod umivaonika.

Provjerite priključke na vodu i odvod, jer ako nisu dobro učvršćeni i osigurani, može doći do curenja vode.

POSTAVLJANJE I PRIKLJUČENJE

Tehnički podaci

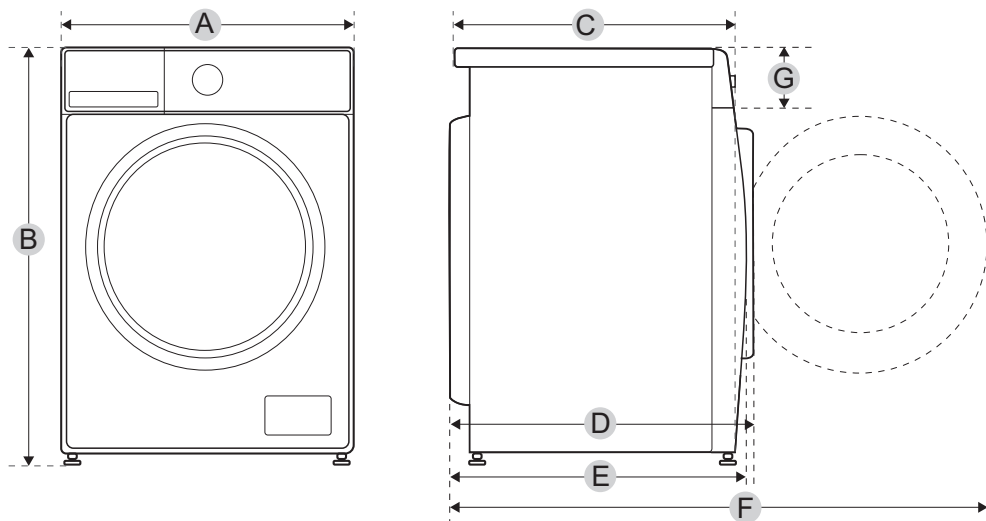

Napon	220-240V~ 50Hz			
MAX. struja	10A			
Standardni tlak vode	0.05MPa ~ 1MPa			
Model	PR127MG17INV	PR148MG17INV	PR149MG17INV	PR1410MG17INV
Kapacitet pranja	7.0kg (1200 o/min)	8.0kg (1400 o/min)	9.0kg (1400 o/min)	10.0kg (1400 o/min)
Dimenzije				
A	595mm	595mm	595mm	595mm
B	850mm	850mm	850mm	850mm
C	400mm	470mm	530mm	530mm
Težina	57kg	63kg	65kg	65kg
Nazivna snaga	2000W	2000W	2000W	2000W
Ostale dimenzije				
D	470mm	540mm	600mm	600mm
E	445mm	521mm	540mm	540mm
F	935mm	985mm	1045mm	1045mm
G	135mm	135mm	135mm	135mm

Opis proizvoda

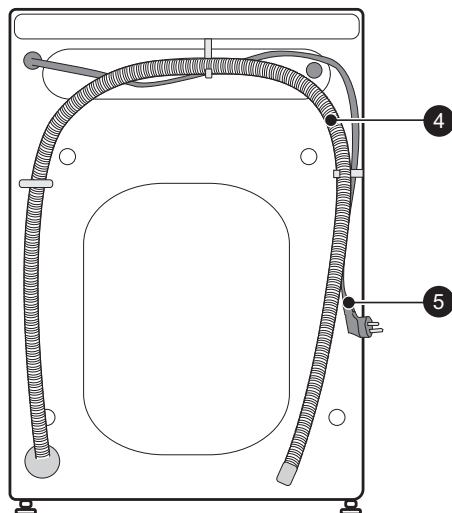
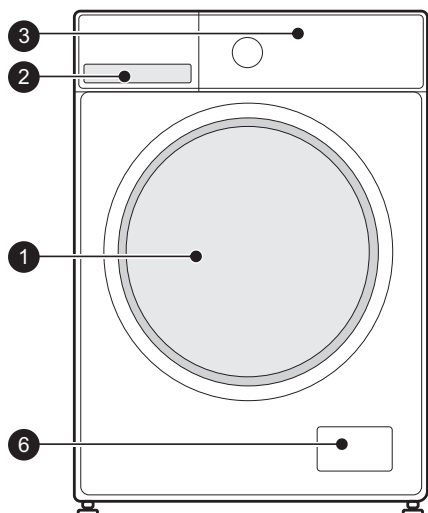

1	Vrata
2	Ladica za deterdžent
3	Upravljačka ploča

4	Odvodno crijevo
5	Električni vod s utikačem
6	Vrata filtera

Prikazani crteži su samo informativne naravi i mogu se razlikovati od stvarnog proizvoda. Neki dijelovi mogu biti opcija i ne moraju biti uključeni u proizvod. U uputama za uporabu mogu biti opisani različiti tipovi aparata koji se međusobno razlikuju po opremljenosti i načinu rada, te su zbog toga uključena i neka poglavlja, podaci i crteži koja za Vaš aparat ne dolaze u obzir.

Pribor

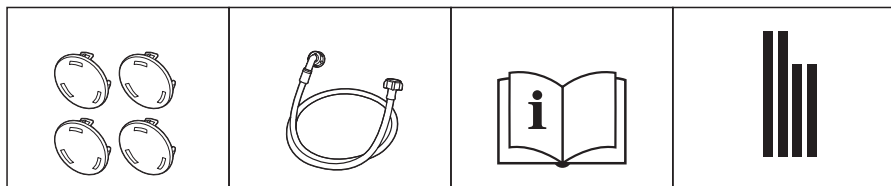

Poklopci za transportne otvore

Crijevo za priključak na hladnu vodu

Upute za uporabu

Spužva za zvučnu izolaciju (opcija)

Brze upute

Pozornost!

Aparat mora biti propisno postavljen i priključen.

Ako se aparat koristi prvi put tada je potrebno proći cijelu proceduru pranja **ali bez odjeće i detrdženta**, koristeći program Pamuk na 90°C ili Čišćenje Bublja (ovisno o modelu).

Kalibracija aparata (ako je ugrađena, ovisno o modelu)

Aparat ima mogućnost detekcije težine rublja, čime se optimizira rad i svojstva zbog smanjenja potrošnje vode i energije.

Iz tog razloga se preporučuje kalibracija aparata, kako bi ostvario bolja svojstva.

1. Isprazniti bubanj i zatvoriti ga.
2. Priključiti aparat na električnu energiju.
3. Uključiti aparat, te unutar 10 sekundi pritisnuti tipku "Centrifuga" u trajanju od 3 sekunde, dok se na displayu ne prikaže "t19".
4. Pritisnuti "▷|| (Start/Pauza)" za start aparata, početni ispis na displayu je "---", a zatim "****" (zvjezdice označavaju brojeve, npr. 126) što je brzina bubnja u stvarnosti. Kada se vrijednost ustali (brojevi se ne mijenjaju), tada je proces kalibracije završen.

1. Prije početka pranja

1. Priključiti na el. mrežu

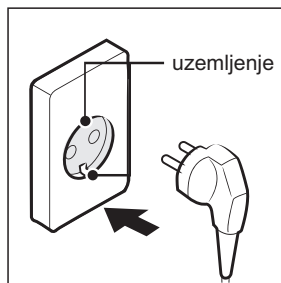

2. Otvoriti pipac za vodu

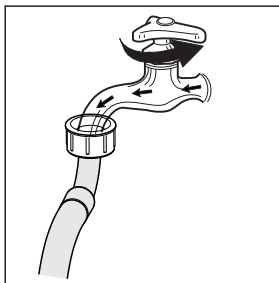

3. Umetnuti rublje

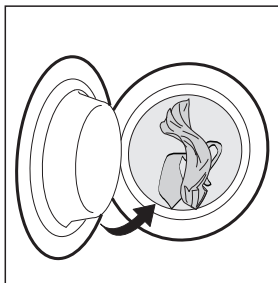

4. Zatvoriti vrata

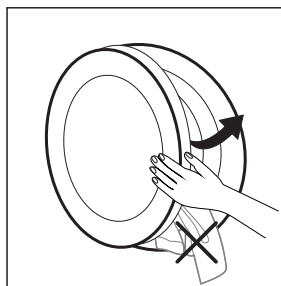

5. Dodati deterdžent

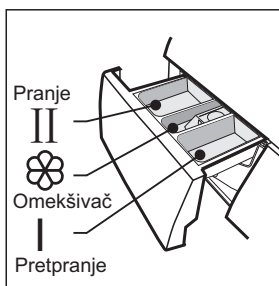

NAPOMENA!

Prilikom zatvaranja vrata pazite da ne priklješite rublje vratima, jer može doći do oštećenja aparata. Deterdžent se dodaje i u odjeljak "I" samo u slučaju ako se odabere pretpiranje (ako aparat ima tu funkciju).

2. Pranje

1. Odabrati program

2. Odabrati funkciju ili ostaviti na osnovno pranje

3. Pokrenuti program na tipku "Start/Pauza"

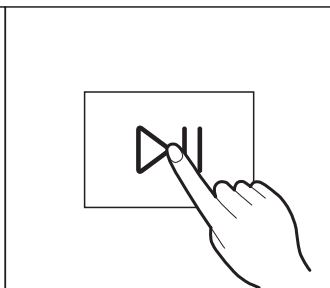
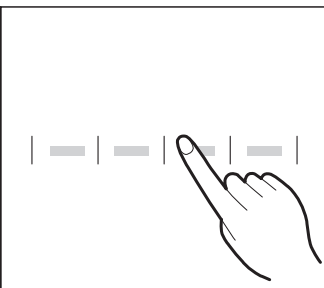
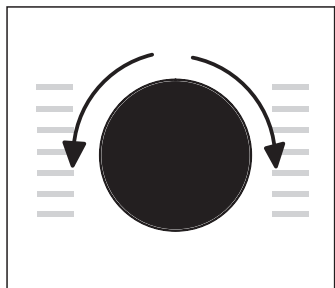

NAPOMENE!

Ako je odabrano osnovno pranje tada se korak 2 može i preskočiti. Izgled crteža je samo informativne naravi kako bi se pokazala procedura.

3. Nakon pranja

Javlja se zvučni signal. Pričekati da se vrata otključaju, te izvaditi rublje. Isključiti aparat iz električne mreže i zatvoriti dovod vode.

Postavljanje i priključenje

Mjesto postavljanja

Pozornost!

Stabilnost je vrlo važna kako bi se spriječilo pomicanje aparata tijekom rada (uslijed vibracija). Aparat mora stajati stabilno i biti niveliran.

Pripazite kako aparat ne bi prignječio električni vod.

Obratite pažnju na minimalne udaljenosti od zidova (prema slici).

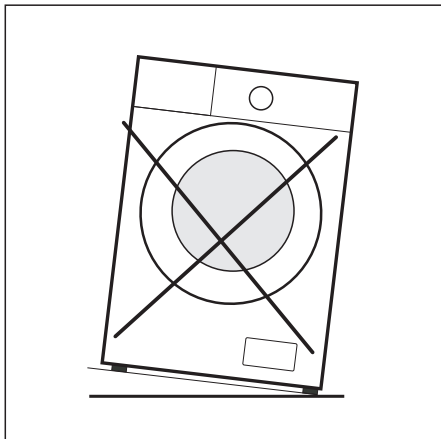
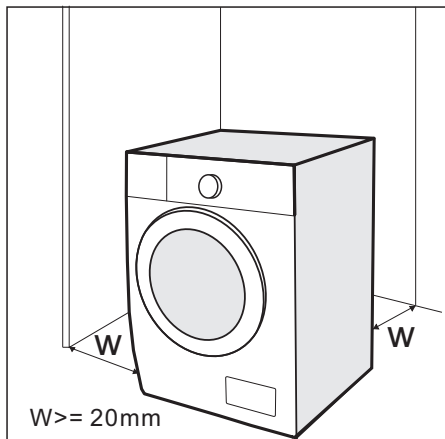

Prije postavljanja i priključenja aparata odaberite odgovarajući prostor s karakteristikama:

1. Suha, čvrsta i ravna podloga
2. Spriječiti direktno izlaganje sunčanim zrakama
3. Odgovarajuće prozračan ili ventiliran prostor
4. Temperatura prostora mora biti iznad 5°C
5. Aparat mora udaljen od izvora topline kao što su plin, drva/ugljen i slično.

Otpakiranje aparata

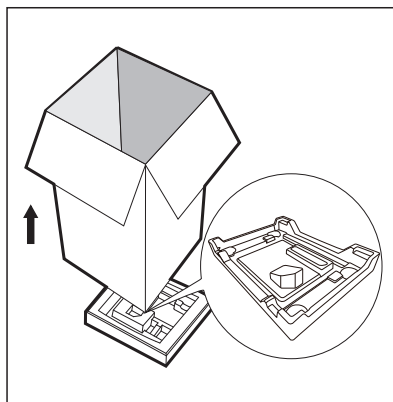

Pozornost!

Ambalažni materijal (plastičnu foliju, stiropor, drvo...) uklonite izvan domašaja djece kako se djeca ne bi ozlijedila ili ugušila.

1. Uklonite kartonsku kutiju i stiroporne umetke.
2. Podignite aparat i uklonite stiropornu bazu na kojoj aparat stoji.
3. Uklonite ljepljive trake koje učvršćuju priključni vod i odvodno crijevo.
4. Izvadite crijevo za dovod vode iz bubnja (i ostale predmete ako su unutra).

Ako želite ponovno zapakirati aparat, tada je postupak suprotan od otpakivanja.

Uklanjanje transportnih blokada (vijaka)

⚠ Pozornost!

Obvezatno uklonite transportne blokade (vijke) sa stražnje strane aparata prije njegove uporabe, te ih spremite na sigurno mjesto. Transportni vijci su opet potrebni ako postavljate aparat na drugo mjesto.

1. Olabavite 4 vijka pomoću odgovarajućeg ključa te ih odvijte.

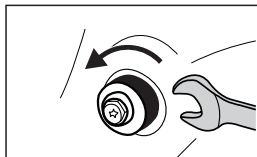

2. Izvucite vijke i gumene dijelove iz otvora, te ih spremite na sigurno.

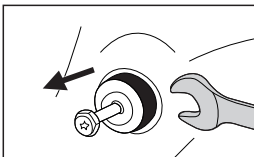

3. Pokrijte 4 otvora s poklopcima iz pribora.

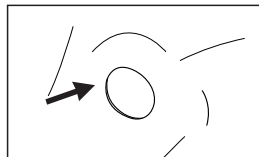

Niveliranje aparata

⚠ Pozornost!

Sve četiri matice na nožicama moraju biti čvrsto pritegnute uz dno kućišta aparata.

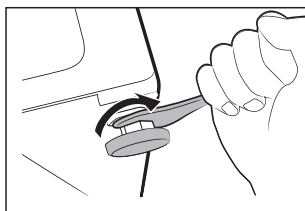

1. Olabavite sigurnosnu maticu.
2. Odvrćite odgovarajuću nožicu dok ne dođe u kontakt s podom.
3. Postavite libelu na gornju ploču aparata, te okretanjem nožica podesite ravninu. Nožice osigurajte pritezanjem sigurnosne matice ključem.

Aparat mora stajati stabilno i nivelirano na tvrdom podu. **NE POSTAVLJAJTE NIŠTA ISPOD NOŽICA** (komadiće drveta, pločice is slično).

Priključak aparata na vodu

⚠ Pozornost!

Obratite pozornost i pratite upute kako ne bi došlo do curenja vode i mogući nastanak štete. Nije dozvoljeno uvijanje, gnječenje, modificiranje ili rezanje crijeva za priključak na vodu.

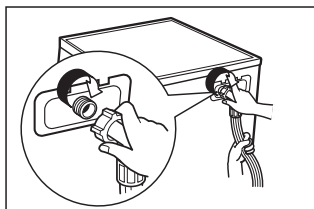

Priključite crijevo za dovod vode na priključak za ulaz vode na stražnjem dijelu aparata, a drugi kraj crijeva priključite na pipu za hladnu vodu. Čvrsto zategnite plastične matice.

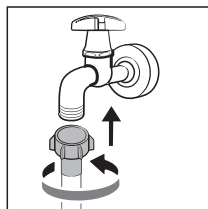

Priključite manualno i dobro zategnite matice bez uporabe alata. Provjeriti jesu li priključci sigurni i čvrsti, te da li propuštaju vodu.

Odvod vode (odvodno crijevo)

⚠ Pozornost!

Obratite pozornost i pravilno postavite odvodno crijevo. U suprotnom može doći do curenja vode i oštećenja. Nije dozvoljeno savijanje ili produžavanje odvodnog crijeva.

Moguća su dva načina postavljanja izlaznog kraja odvodnog crijeva:

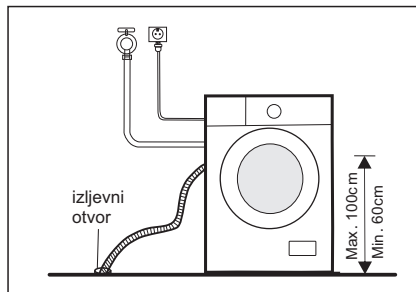

1. Umetnuti kraj crijeva u izljevni otvor i osigurati od vađenja.

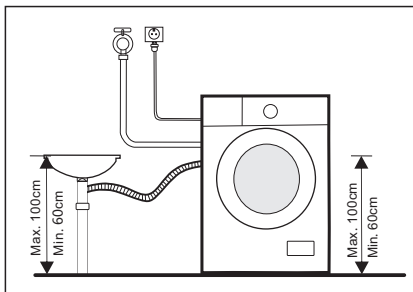

2. Umetnuti kraj crijeva u T-komad na odvodnoj cijevi umivaonika.

Spužve ili panel protiv buke (ovisno o modelu)

⚠ Pozornost!

NE UKLANJATI NOŽICE ZA NIVELIRANJE !

Spužve ili panel služi samo kao virtualno umanjeње buke rada aparata.

Polegnuti aparat i zaljepiti 2 duže spužve na dulji donji rub, a 2 kraće spužve na donji kraći rub aparata. Instalacija panela je isto kao i kod spužvi.

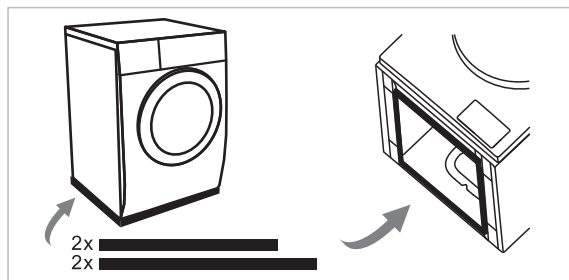

ili

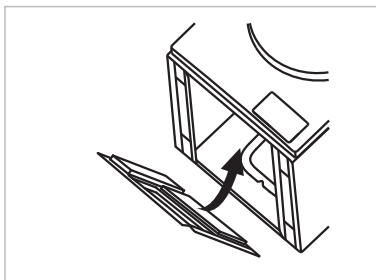

Prije svakog pranja

Radni uvjeti predviđeni za aparat trebali bi biti između 5-40°C. Aparat se ne smije koristiti na temperaturama ispod 0°C jer može doći do smrzavanja te oštećenja ulaznog ventila, crijeva i pumpe. Ako se aparat nalazi na tako niskoj temperaturi, tada ga je potrebno postaviti u prostor s normalnom temperaturom, a to će osigurati da ne dođe do smrzavanja prije uporabe.

Obvezatno provjeriti podatke o deterdžentu koji će se koristiti u pranju.

Koristiti deterdžente koji se malo ili nimalo pjene, a prikladni su za strojno pranje rublja.

Obvezatno provjeriti etikete na odjevnim predmetima o vrsti tkanine, načinu pranja, najvišoj temperaturi pranja i ostalim svojstvima.

1. Izvaditi predmete iz džepova

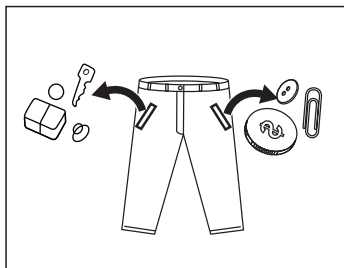

2. Odvojiti i složiti odjeću prema vrstama tkanine

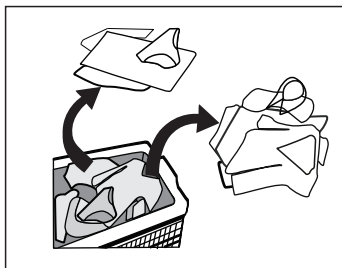

3. Zavezati vezice te zatvoriti patent zatvarače

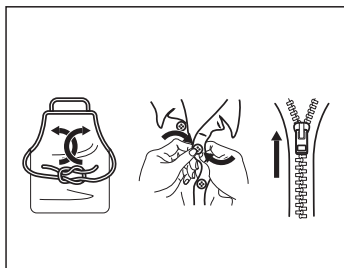

4. Staviti malenu ili vrlo osjetljivu odjeću u specijalne vreće za pranje

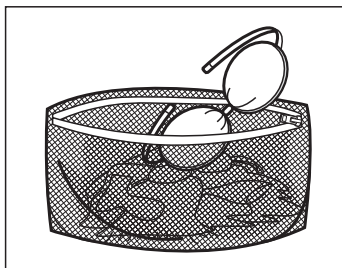

⚠ Pozornost!

Ako se pere vrlo mala količina odjeće (1 komad), može doći do većeg ekscentriciteta te drmanja i lupanja, čime se uključuje signal za veliku nebalansiranost. Zato je preporučljivo da se doda još odjeće kako bi se postigla bolja uravnoteženost tijekom pranja.

Nije dozvoljeno pranje odjeće koja je natopljena zapaljivim materijalima (benzin, petrolej, nafta, alkohol i ostalo.) Ovo je već prije opisano.

Nije dozvoljeno pranje ili centrifugiranje vodonepropusnih sjedala, tepiha i odjeće.

Ladica za deterdžent

I Odjeljak za deterdžent za pretpranje

II Odjeljak za deterdžent za pranje

☼ Odjeljak za omekšivač

☉ Poluga za oslobađanje ladice kako bi se mogla kompletno izvaditi van.

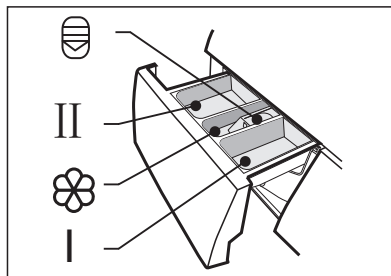

NAPOMENA!

Deterdžent se dodaje u odjeljak "I" samo u slučaju ako se odabere pretpranje (ako aparat ima tu funkciju).

Program	I	II	☼
Pamuk	<input type="radio"/>	<input checked="" type="radio"/>	<input type="radio"/>
Sintetika	<input type="radio"/>	<input checked="" type="radio"/>	<input type="radio"/>
Mješovito	<input type="radio"/>	<input checked="" type="radio"/>	<input type="radio"/>
Sport	<input type="radio"/>	<input checked="" type="radio"/>	<input type="radio"/>
Dječja odjeća	<input type="radio"/>	<input checked="" type="radio"/>	<input type="radio"/>
Traper	<input type="radio"/>	<input checked="" type="radio"/>	<input type="radio"/>
ECO 40-60		<input checked="" type="radio"/>	<input type="radio"/>
Čišćenje bubnja			
Centrifugiranje			
Voluminozno	<input type="radio"/>	<input checked="" type="radio"/>	<input type="radio"/>
Vuna		<input checked="" type="radio"/>	<input type="radio"/>
Brzo 15'		<input checked="" type="radio"/>	<input type="radio"/>
Brzo 45'		<input checked="" type="radio"/>	<input type="radio"/>
20°C		<input checked="" type="radio"/>	<input type="radio"/>
Parno pranje	<input type="radio"/>	<input checked="" type="radio"/>	<input type="radio"/>

● Obvezatno

○ Po želji (opcija)

Uporaba deterdženta

Preporuka za uporabu deterdženta za pranje	Vrsta rublja ili tekstila	Ciklus pranja (program)	Temp. pranja
Snažni deterdženti sa sredstvima za izbjeljivanje	Rublje od bijele pamučne ili lanene tkanine otporne na visoke temperature pranja	Pamuk, ECO 40-60	40/60°C
Color deterdženti (za pranje obojenih tkanina), bez sredstva za izbjeljivanje	Obojeno (šareno) rublje od pamučne ili lanene tkanine	Pamuk	20/40°C
Color ili blagi deterdženti bez sredstva za izbjeljivanje	Obojeno (šareno) rublje od sintetičke ili tkanina koje se lako održavaju	Pamuk, sintetička	20/40°C
Blagi deterdženti za pranje	Osjetljive tkanine, svila, viskoza	Sintetička	20°C
Specijalni deterdženti za vunu	Vuna	Vuna	20/40°C

NAPOMENE!

Ako se koriste granulasti ili vrlo gusti i ljepljivi deterdženti ili aditivi, prije njihovog stavljanja u odjeljak, potrebno ih je razrijediti s vodom kako bi se spriječilo začepljivanje izlaza iz odjeljka a time i preljevanje vode iz ladice kada aparat uzima vodu.

Potrebno je odabrati odgovarajući deterdžent za odgovarajuću temperaturu pranja kako bi se postigle najbolje performanse pranja uz manju potrošnju energije i vode.

Kako bi se ostvarila najbolja čistoća rublja, važno je odgovarajuće doziranje deterdženta.

Potrebno je smanjiti količinu deterdženta ako bubanj nije potpuno napunjen. Neophodno je podesiti količinu deterdženta prema tvrdoći vode (ako je voda iz vodovoda meka, tada treba manje deterdženta).

Doziranje deterdženta ovisi o nivou zaprljanosti, jer manje zaprljano rublje zahtjeva manju količinu deterdženta.

Visoko koncentrirani (kompaktni) deterdženti zahtjevaju pažljivo i točno doziranje.

Pojava jakog pjenjenja i loši rezultati pranja i ispiranja, posljedice su prevelike količine deterdženta.

Ako je oprano rublje sivo ili ako se pojavljuje gomilanje ostataka (mucica) na bubnju, grijačem elementu i rublju, to je posljedica premalene količine deterdženta.

Upravljački elementi i njihova uporaba

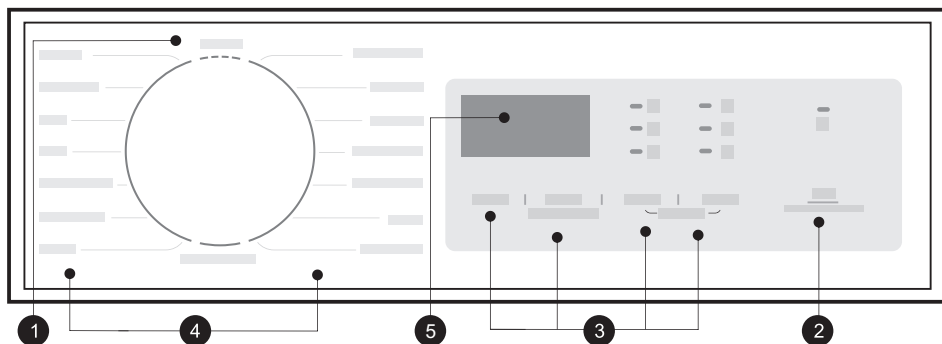

NAPOMENA!

Crteži i skice samo su informativne naravi i može se razlikovati od stvarnog izgleda na aparatu.

- | | |
|--|---|
| <p>1 0</p> <p>Kada je držak u položaju "0" tada je aparat isključen.</p> | <p>2 Start/Pauza</p> <p>Tipka za pokretanje ili pauziranje ciklusa pranja.</p> |
| <p>3 Dodaci</p> <p>Tipka za odabir dodatnih funkcija čiji će se simbol pojaviti na displayu.</p> | <p>4 Programi</p> <p>Držak za odabir raznih programa prema vrsti rublja.</p> |
| <p>5 Display (pokazivač)</p> <p>Display (pokazivač) pokazuje postavke, funkcije, procijenjeno preostalo vrijeme te statusne poruke na aparatu. Display će svjetliti tijekom ciklusa pranja/sušenja.</p> | |

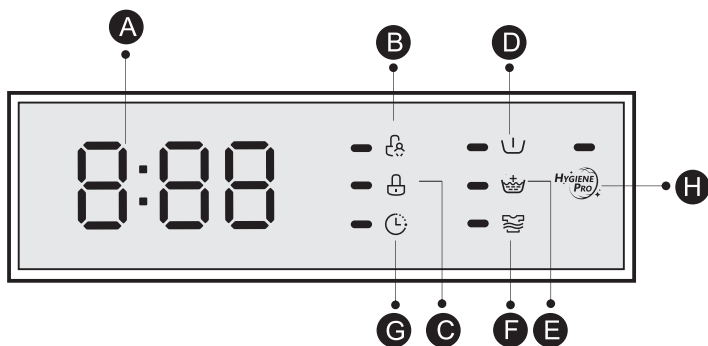

- | | | |
|---|---|--|
| <p>A Display</p> <p>Vrijeme pranja
125</p> <p>Brzina centrifuge
400</p> <p>Kraj
End</p> <p>Vrijeme odgode
2H</p> <p>Kod greške
E30</p> <p>Temperatura
30</p> | <p>B Zaštita za djecu</p> <p>D Pretpranje</p> <p>F Intenzivno pranje</p> <p>H HYGIENE PRO</p> | <p>C Blokirana vrata</p> <p>E Dodatno ispiranje</p> <p>G Odgoda</p> |
|---|---|--|

Tablica programa

Program	Kapacitet (kg)				Vrijeme trajanja (h:mm)			
	7kg	8kg	9kg	10kg	7kg	8kg	9kg	10kg
<i>Kapacitet perilice</i>								
Pamuk	7.0	8.0	9.0	10.0	1:38	3:49	3:49	3:49
Sintetika	3.5	4.0	4.5	5.0	2:08	3:28	3:28	3:28
Mješovito	7.0	8.0	9.0	10.0	1:30	1:30	1:30	1:30
20°C	3.5	4.0	4.5	5.0	1:11	1:11	1:11	1:11
Sport	3.5	4.0	4.5	5.0	0:57	0:57	0:57	0:57
Dječja odjeća	7.0	8.0	9.0	10.0	1:52	1:52	1:52	1:52
Traper	7.0	8.0	9.0	10.0	1:56	1:56	1:56	1:56
Parno pranje	3.5	4.0	4.5	5.0	1:58	1:58	1:58	1:58
Centrifugiranje	7.0	8.0	9.0	10.0	0:12	0:12	0:12	0:12
Voluminozno	7.0	8.0	9.0	10.0	1:48	1:48	1:48	1:48
Vuna	2.0	2.0	2.0	2.0	1:07	1:07	1:07	1:07
ECO 40-60	7.0	8.0	9.0	10.0	3:28	3:38	3:48	3:59
Čišćenje bubnja	--	--	--	--	1:28	1:28	1:28	1:28
Brzo 15'	2.0	2.0	2.0	2.0	0:15	0:15	0:15	0:15
Brzo 45'	2.0	2.0	2.0	2.0	0:45	0:45	0:45	0:45

Napomena !

Podaci u tablicama samo su informativne naravi. Stvarni parametri mogu odstupati od parametara prikazanih u tablicama. Vrijednosti trajanja programa, potrošnje energije i vode mogu se razlikovati u ovisnosti od opterećenja i vrste rublja, odabranih dodatnih funkcija, tipa vode, odabranog deterdženta i temperature okoliša. Stvarni parametri ovise o tome kako će se aparat koristiti. Tablicu uzeti samo kao približni orijentir.

Program	Kapacitet (kg)	Temperatura (°C)	Vrijeme trajanja (hh:mm)	Potrošnja energije (kW/ciklus)	Potrošnja vode (litara/ciklus)	Najviša temperatura (°C) (1)	Preostala vlaga (%/brzina centrifuge) (2)
Pamuk	7.0	40	1:38	0.727	65	40	70%/800
Mješovito	7.0	40	1:30	0.713	65	40	70%/800
20°C	3.5	20	1:11	0.194	41	20	65%/1000
Dječja odjeća	7.0	60	1:52	1.196	65	60	65%/1000
Brzo 15'	2.0	Hladno	0:15	0.030	31	Hladno	70%/800
ECO 40-60 (3)	7.0	--	3:28	0.670	52.0	37	62.9%/1200
	3.5	--	2:42	0.405	44.0	33	62.9%/1200
	2.0	--	2:42	0.167	36.0	23	62.9%/1200

PR127MG17INV

Napomena !

Podaci u tablicama samo su informativne naravi. Stvarni parametri mogu odstupati od parametara prikazanih u tablicama. Stvarni parametri ovise o tome kako će se aparat koristiti. Tablicu uzeti samo kao približni orijentir.

Vrijednosti za programe različite od "ECO 40-60" jesu samo za informaciju.

20°C može prati samo lagano zaprljano pamučno rublje, pri nominalnoj temperaturi od 20°C, a što je u skladu s regulativom (EU) 2019/2023.

U skladu s Regulativama EN 60456:2016+A11:2020 sa (EU) 2019/2014, (EU) 2019/2023, (EU) 2021/340, (EU) 2021/341.

EU energetska učinkovitost: A

Program za testiranje: ECO 40-60. Ostale postavke su osnovne.

Polu punjenja za 7.0kg aparat iznosi 3.5kg.

Četvrtina punjenja za 7.0kg aparat iznosi 2.0kg.

- 1) Najviša postignuta temperatura rublja u ciklusu pranja koje traje najmanje 5 min.
- 2) Preostala vlaga nakon ciklusa pranja u vodi, sadrži postotak i broj okretaja centrifuge pri kojoj je ta vrijednost doegnuta.
- 3) Program ECO40-60 omogućuje pranje normalno zaprljanog pamučnog rublja, koje je perivo od 40°C ili 60°C, zajedno u istom ciklusu. Ovaj se program koristi unutar regulative (EU) 2019/2023.

Programi sa najvećom učinkovitosti glede potrošnje energije jesu općenito oni koji se izvode duže vremena pri nižim temperaturama.

Punjenje rubljem, perilice rublja za kućanstvo, na kapacitet koji odgovara odgovarajućem programu doprinosi uštedi energije i vode.

Razina buke i preostala vlaga su ovisne o brzini vrtnje centrifuge. Veća brzina vrtnje rezultira većom razinom buke, ali manjom preostalom vlagom.

Program	Kapacitet (kg)	Temperatura (°C)	Vrijeme trajanja (hh:mm)	Potrošnja energije (kW/ciklus)	Potrošnja vode (litara/ciklus)	Najviša temperatura (°C) (1)	Preostala vlaga (%/brzina centrifuge) (2)
Pamuk	8.0	60	3:54	1.515	71	60	53%/1400
Mješovito	8.0	40	1:30	0.772	71	40	70%/800
20°C	4.0	20	1:11	0.200	44	20	65%/1000
Brzo 15'	2.0	Hladno	0:15	0.030	31	Hladno	70%/800
Voluminozno	8.0	40	1:48	0.803	71	40	65%/1000
ECO 40-60 (3)	8.0	--	3:38	0.752	61.0	33	53.9%/1350
	4.0	--	2:48	0.412	45.0	28	53.9%/1350
	2.0	--	2:48	0.216	36.0	24	53.9%/1350

PR148MG17INV

Napomena !

Podaci u tablicama samo su informativne naravi. Stvarni parametri mogu odstupati od parametara prikazanih u tablicama. Stvarni parametri ovise o tome kako će se aparat koristiti. Tablicu uzeti samo kao približni orijentir.

Vrijednosti za programe različite od "ECO 40-60" jesu samo za informaciju.

20°C može prati samo lagano zaprljano pamučno rublje, pri nominalnoj temperaturi od 20°C, a što je u skladu s regulativom (EU) 2019/2023.

U skladu s Regulativama EN 60456:2016+A11:2020 sa (EU) 2019/2014, (EU) 2019/2023, (EU) 2021/340, (EU) 2021/341.

EU energetska učinkovitost: A

Program za testiranje: ECO 40-60. Ostale postavke su osnovne.

Polu punjenja za 8.0kg aparat iznosi 4.0kg.

Četvrtina punjenja za 8.0kg aparat iznosi 2.0kg.

- 1) Najviša postignuta temperatura rublja u ciklusu pranja koje traje najmanje 5 min.
- 2) Preostala vlaga nakon ciklusa pranja u vodi, sadrži postotak i broj okretaja centrifuge pri kojoj je ta vrijednost doegnuta.
- 3) Program ECO40-60 omogućuje pranje normalno zaprljanog pamučnog rublja, koje je perivo od 40°C ili 60°C, zajedno u istom ciklusu. Ovaj se program koristi unutar regulative (EU) 2019/2023.

Programi sa najvećom učinkovitosti glede potrošnje energije jesu općenito oni koji se izvode duže vremena pri nižim temperaturama.

Punjenje rubljem, perilice rublja za kućanstvo, na kapacitet koji odgovara odgovarajućem programu doprinosi uštedi energije i vode.

Razina buke i preostala vlaga su ovisne o brzini vrtnje centrifuge. Veća brzina vrtnje rezultira većom razinom buke, ali manjom preostalom vlagom.

Program	Kapacitet (kg)	Temperatura (°C)	Vrijeme trajanja (h:min)	Potrošnja energije (kW/ciklus)	Potrošnja vode (litara/ciklus)	Najviša temperatura (°C) (1)	Preostala vlaga (%/brzina centrifuge) (2)
Pamuk	9.0	60	3:54	1.620	78	60	53%/1400
Mješovito	9.0	40	1:30	0.830	78	40	70%/800
20°C	4.5	20	1:11	0.206	48	20	65%/1000
Brzo 15'	2.0	Hladno	0:15	0.030	31	Hladno	70%/800
Voluminozno	9.0	40	1:48	0.862	78	40	65%/1000
ECO 40-60 (3)	9.0	--	3:48	0.808	67.0	36	53.9%/1350
	4.5	--	2:54	0.498	49.0	32	53.9%/1350
	2.5	--	2:54	0.225	36.0	25	53.9%/1350

PR149MG17INV

Napomena !

Podaci u tablicama samo su informativne naravi. Stvarni parametri mogu odstupati od parametara prikazanih u tablicama. Stvarni parametri ovise o tome kako će se aparat koristiti. Tablicu uzeti samo kao približni orijentir.

Vrijednosti za programe različite od "ECO 40-60" jesu samo za informaciju.

20°C može prati samo lagano zaprljano pamučno rublje, pri nominalnoj temperaturi od 20°C, a što je u skladu s regulativom (EU) 2019/2023.

U skladu s Regulativama EN 60456:2016+A11:2020 sa (EU) 2019/2014, (EU) 2019/2023, (EU) 2021/340, (EU) 2021/341.

EU energetska učinkovitost: A

Program za testiranje: ECO 40-60. Ostale postavke su osnovne.

Pola punjenja za 9.0kg aparat iznosi 4.5kg.

Četvrtina punjenja za 9.0kg aparat iznosi 2.5kg.

- 1) Najviša postignuta temperatura rublja u ciklusu pranja koje traje najmanje 5 min.
- 2) Preostala vlaga nakon ciklusa pranja u vodi, sadrži postotak i broj okretaja centrifuge pri kojoj je ta vrijednost doegnuta.
- 3) Program ECO40-60 omogućuje pranje normalno zaprljanog pamučnog rublja, koje je perivo od 40°C ili 60°C, zajedno u istom ciklusu. Ovaj se program koristi unutar regulative (EU) 2019/2023.

Programi sa najvećom učinkovitosti glede potrošnje energije jesu općenito oni koji se izvode duže vremena pri nižim temperaturama.

Punjenje rubljem, perilice rublja za kućanstvo, na kapacitet koji odgovara odgovarajućem programu doprinosi uštedi energije i vode.

Razina buke i preostala vlaga su ovisne o brzini vrtnje centrifuge. Veća brzina vrtnje rezultira većom razinom buke, ali manjom preostalom vlagom.

Program	Kapacitet (kg)	Temperatura (°C)	Vrijeme trajanja (hh:mm)	Potrošnja energije (kW/ciklus)	Potrošnja vode (litara/ciklus)	Najviša temperatura (°C) (1)	Preostala vlaga (%/brzina centrifuge) (2)
Pamuk	10.0	60	3:54	1.726	85	60	53%/1400
Mješovito	10.0	40	1:30	0.889	85	40	70%/800
20°C	5.0	20	1:11	0.212	51	20	65%/1000
Brzo 15'	2.0	Hladno	0:15	0.030	31	Hladno	70%/800
Voluminozno	10.0	40	1:48	0.920	85	40	65%/1000
ECO 40-60 (3)	10.0	--	3:59	0.895	67.0	41	53.9%/1350
	5.0	--	3:00	0.560	52.0	33	53.9%/1350
	2.5	--	3:00	0.232	41.5	23	53.9%/1350

PR1410MG17INV

Napomena !

Podaci u tablicama samo su informativne naravi. Stvarni parametri mogu odstupati od parametara prikazanih u tablicama. Stvarni parametri ovise o tome kako će se aparat koristiti. Tablicu uzeti samo kao približni orijentir.

Vrijednosti za programe različite od "ECO 40-60" jesu samo za informaciju.

20°C može prati samo lagano zaprljano pamučno rublje, pri nominalnoj temperaturi od 20°C, a što je u skladu s regulativom (EU) 2019/2023.

U skladu s Regulativama EN 60456:2016+A11:2020 sa (EU) 2019/2014, (EU) 2019/2023, (EU) 2021/340, (EU) 2021/341.

EU energetska učinkovitost: A

Program za testiranje: ECO 40-60. Ostale postavke su osnovne.

Pola punjenja za 10.0kg aparat iznosi 5.0kg.

Četvrtina punjenja za 10.0kg aparat iznosi 2.5kg.

- 1) Najviša postignuta temperatura rublja u ciklusu pranja koje traje najmanje 5 min.
- 2) Preostala vlaga nakon ciklusa pranja u vodi, sadrži postotak i broj okretaja centrifuge pri kojoj je ta vrijednost doegnuta.
- 3) Program ECO40-60 omogućuje pranje normalno zaprljanog pamučnog rublja, koje je perivo od 40°C ili 60°C, zajedno u istom ciklusu. Ovaj se program koristi unutar regulative (EU) 2019/2023.

Programi sa najvećom učinkovitosti glede potrošnje energije jesu općenito oni koji se izvode duže vremena pri nižim temperaturama.

Punjenje rubljem, perilice rublja za kućanstvo, na kapacitet koji odgovara odgovarajućem programu doprinosi uštedi energije i vode.

Razina buke i preostala vlaga su ovisne o brzini vrtnje centrifuge. Veća brzina vrtnje rezultira većom razinom buke, ali manjom preostalom vlagom.

Programi koji su dostupni prema vrsti rublja.









































Programi	
Pamuk	Pamučne i lanene tkanine otporne na više temperature.
Brzo 45'	Brzo pranje manje količine odjeće, koja nije jako zaprljana.
Sintetika	Pranje rublja od sintetičkih tkanina. Majice, jakne, miješano. Tijekom pranja pletenih tkanina potrebno je smanjiti količinu deterdženta zbog slabije konstitucije vlakana i jačeg stvaranja pjene.
Dječja odjeća	Pogodno za pranje odjeće za djecu. Čini odjeću čišćom, a bolje svojstvo ispiranja potpomaže u zaštiti dječje kože.
Traper	Specijalno za pranje odjeće od traper (jeans-a).
Mješovito	Zajedničko pranje odjeće od pamučnih i sintetičkih tkanina.
20°C	Pranje lagano zaprljanog pamučnog rublja na temperaturi 20°C.
Sport	Pranje odjeće namjenjene za sport i aktivnosti.
Brzo 15'	Kratak program za brzo pranje odjeće. Prikladno za lagano zaprljano rublje kao i za malu količinu rublja.
Voluminozno	Pogodno za pranje voluminoznog rublja.
Vuna	Pranje vunениh tkanina za ručno ili strojno pranje, kao i od tkanina s većim sadržajem vune. Vrlo nježan program pranja kojim se sprječava skupljanje, duže su pauze u programu (pa su tkanine duže u vodi).
Centrifugiranje	Centrifugiranje i izbacivanje vode.
ECO 40-60	Pranje normalno zaprljanog pamučnog rublja deklariranog za pranje na 40°C ili 60°C, zajedno u istom ciklusu.
Parno pranje	Dodaje se para u ciklusu pranja.
Čišćenje bubnja	Posebni program za čišćenje bubnja i cijevi. Program podiže temperaturu na 90°C kako bi sterilizirao unutrašnje površine te kako bi pranje rublja, nakon toga, bilo više ekološki čisto. Pri uporabi ovog programa ne stavlja se rublje ili deterdžent. Program se koristi uobičajeno ili prema potrebi.

Napomena !

Podaci u tablicama samo su informativne naravi. Stvarni parametri su na realnom proizvodu.

Nakon završetka programa, na displayu treperi "End". Držak programa postaviti u položaj "0".

Dodaci

Program	Osnovna temperatura (°C)	Osnovna brzina centrifuge (okr/min)		Dodatne funkcije
		1200	1400	
Pamuk	40	800	1400	 ,  ,  , 
Sintetika	40	800	1200	 ,  ,  , 
Mješovito	40	800	800	 ,  ,  , 
20°C	20	1000	1000	 , 
Sport	20	800	800	 ,  , 
Dječja odjeća	60	1000	1000	 ,  ,  , 
Traper	60	800	800	 ,  , 
Čišćenje bubnja	90	-	-	
Centrifugiranje	-	1000	1000	
Voluminozno	40	1000	1000	 ,  ,  , 
Vuna	40	600	600	 , 
ECO 40-60	-	1200	1400	
Parno pranje	40	1000	1000	 ,  ,  , 
Brzo 15'	Hladno	800	800	
Brzo 45'	20	800	800	 , 

 Odgoda

 Intenzivno pranje

 Dodatno ispiranje

 Pretpranje

Napomena !

Za maksimalne brzine vrtnje, trajanje programa te ostale detalje oko programa "ECO 40-60" i "Pranje i Sušenje", potrebno je konzultirati informacijski list. Tablica prikazuje koje su funkcije moguće na kojem programu.

Temperatura

Temperatura

Pritiskanjem tipke odabire se temperatura:

Hladno (cold), 20°C , 30°C , 40°C , 60°C , 90°C

Centrifuga

Centrifuga

Pritiskanjem tipke odabire se brzina centrifuge:

0 , 400 , 600 , 800 , 1000 , 1200 , 1400 o/min (aparatus sa 1400o/min)

0 , 400 , 600 , 800 , 1000 , 1200 o/min (aparatus sa 1200o/min)

Odgoda

Odgoda

Podešavanje funkcije odgode:

1. Odabrati program
2. Pritisnuti tipku "Odgoda" kako bi se odabralo vrijeme (0-24 sata)
3. Pritisnuti tipku "Start/Pauza" za potvrdu funkcije



Odabrati
program



Podesiti vrijeme
odgode



Start

Poništenje funkcije odgode:

Pritiskati tipku "Odgoda" dok se na displayu ne pojavi 0H. Ovo treba napraviti prije nego što se program pokrene. Ako je već program u tijeku, tada je potrebno okrenuti držak programatora na "0" kako bi se program poništio, pa ponovno odabrati novi program.



Pretpranje

Pretpranje je funkcija koja omogućuje dodatno pranje rublja prije početka glavnog programa pranja, a pogodna je za pranje prašnjavog i jako prljavog rublja.

Potrebno je umetnuti deterdžent u odjeljak "I".



Dodatno ispiranje

Funkcija kojom se rublje podvrgava dodatnom ispiranju.



Intenzivno pranje

Funkcija kojom se produžuje vrijeme i intenzitet pranja, što je pogodno za jako zaprljano rublje.



HYGIENE PRO

Kada ovaj simbol svjetli, tada je funkcija automatski aktivirana unutar programa. Funkcija će se automatski uključiti tijekom svakog ciklusa pranja.

Hygiene Pro sistem uvijek će osigurati rublje čistim.



Roditeljsko zaključavanje (zaštita za djecu)

Aparat posjeduje posebnu funkciju za sigurnost djece, a kojim se onemogućuju nehotični pritisci na tipke.



Pritisnuti tipke "Odgoda" i "Funkcija" 3 sekunde dok se ne javi zvučni signal

Pozornost!

Roditeljsko zaključavanje blokira sve tipke osim "Roditeljsko zaključavanje". Pritiskom "Odgoda" i "Funkcija", funkcija se poništava.

Funkciju zaštite za djecu potrebno je poništiti prije odabira novog program.

Kada je funkcija aktivirana i program se starta, upali se simbol zaštite za djecu, te se na displayu trepere preostalo vrijeme i "CL".

Pritiskom na bilo koju tipku uzrokuje treperenje simbola zaštite za djecu.

Nakon što program završi, na displayu će se izmjenjivati "CL" i "END".



Isključenje zvučnog signala

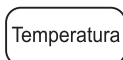

Temperatura

Pritisnuti tipku "Temperatura" te držati 3 sekunde za isključenje zvučnog signala.

Odabrati program



Za uključenje zvučnog signala pritisnuti iste tipke i držati 3 sekunde. Postavke će biti zapamćene do slijedećeg reseta.

Pozornost!

Nakon isključenja zvučne funkcije, zvukovi se neće moći aktivirati.



Pritisnuti 3 sec. za nadopunu

Nadopuna (dodavanje rublja)

Ova se funkcija može uključiti tijekom izvršavanja programa.

Dok se bubanj vrti i dok je u njemu velika količina vode i visoka temperatura tada nije uputno niti sigurno niti moguće nasilno otvoriti vrata.

Pritisnuti tipku "Start/Pauza" i držati 3 sekunde kako bi se dodalo rublje tijekom procesa pranja. Nakon toga slijediti ove korake:

1. Pričekati da se bubanj prestane vrtiti.
2. Pričekati da se mehanizam vrata otključa kako bi se mogla otvoriti.
3. Dodati rublje, zatvoriti vrata te pritisnuti tipku "Start/Pauza".



Odjeća



ODRŽAVANJE APARATA

Čišćenje i održavanje

⚠ Pozornost!

Prije početka održavanja, potrebno je isključiti aparat iz električne mreže te zatvoriti dovod vode.

Čišćenje kućišta aparata

Odgovarajuće održavanje aparata može produžiti radni vijek aparata. Površine se mogu čistiti krpom umočenom u mješavinu vode i tekućeg deterdženta. Deterdžent mora biti neutralan i ne smije biti abrazivan. Ako se uoči procurivanje vode po površini tada je treba odmah obrisati krpom. Nije dozvoljena uporaba oštih i šiljatih predmeta u svrhu čišćenja.

Napomena !

Uporaba kemijskih ili sličnih sredstava (alkohol, kemijska sredstva, otapala, kiseline, ili slično) nije dozvoljeno u svrhu čišćenja.

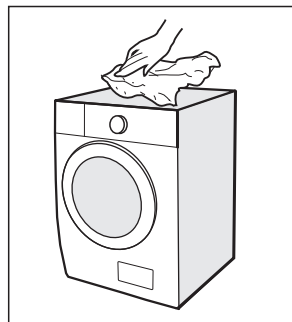

Čišćenje bubnja

Preostala hrđa unutar bubnja, koja je preostala od metalnih predmeta, mora odmah biti uklonjena pomoću deterdženata koji ne sadrže klor. Uporaba metalne vune nije dozvoljeno u svrhu čišćenja.

Napomena !

Ne stavljati rublje u aparat tijekom čišćenja bubnja.

Čišćenje stakla i brtve vrata

Staklo vrata potrebno je obrisati suhom krpom nakon svakog pranja. Tako će se ukloniti sva nečistoća i nakupine. U suprotnom će doći do akumuliranja nakupina što može uzrokovati procurivanje.

Ukloniti sve objekte (novčići, gumbi, i sl.) iz brtvi nakon svakog pranja.

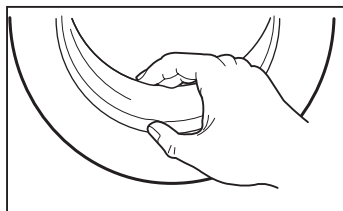

Čišćenje filtera za ulaz vode

Napomena !

Ulazni filter se mora očistiti ako je dotok vode u aparat smanjen.

1. Zatvoriti pipu za vodu.
Odspojiti crijevo za ulaz vode.

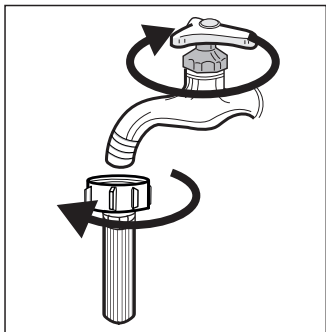

2. Očistiti filter pomoću četkice i vode.
Ponovno spojiti crijevo na pipu.

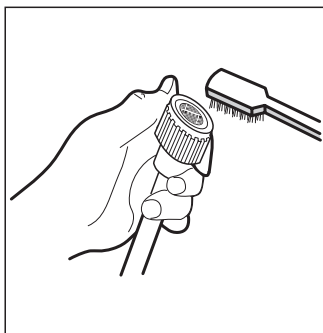

3. Odvrnuti ulazni fitting sa crijevom
na stražnjoj strani aparata.
Izvući filter pomoću odgovarajućeg
alata (kliješta s dugačkim vrhom).

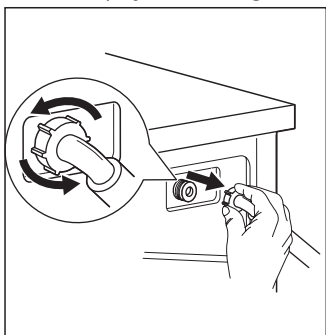

4. Očistiti filatar pomoću četkice i
vode.

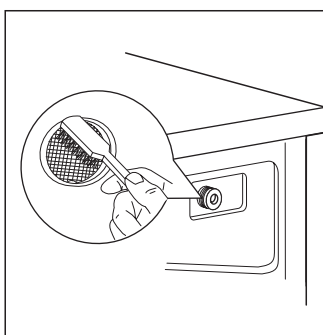

5. Ponovo pričvrstiti fitting za dovod vode na stražnjoj strani aparata, te
zavrnuti crijevo za ulaz vode natrag na pipu.
6. Preporučuje se čišćenje ulaznog filtera svaka 3 mjeseca, čime se
osigurava normalan rad aparata.

Čišćenje ladice za deterdžent

1. Pritisnuti prema dolje strelicu  na pokrovu za omekšivač koji se nalazi unutar ladice te ladicu izvući van.
2. Podići kopču prema gore i izvaditi pokrov omekšivača te vodom sve isprati, a naročito žljebove.
3. Vratiti pokrov za omekšivač te gurnuti ladicu na mjesto.

1. Pritisnuti polugicu te izvući ladicu van

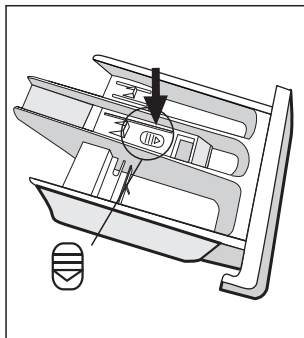

2. Oprati ladicu i pokrov omekšivača ispod mlaza tekuće vode

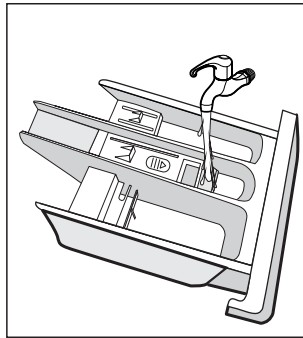

3. Očistiti komoru za ladicu na aparatu pomoću četkice

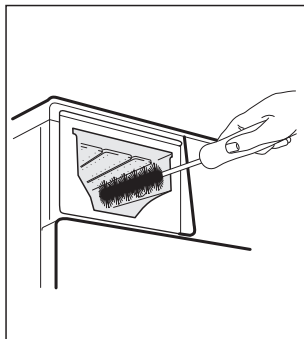

4. Vratiti ladicu natrag u aparat

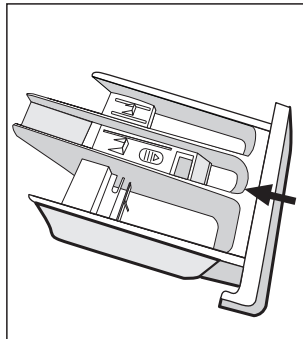

Napomena !

Uporaba abrazivnih te kemijskih ili sličnih sredstava (alkohol, kemijska sredstva, otapala, kiseline, ili slično) nije dozvoljeno u svrhu čišćenja.

Čišćenje ladice za deterdžent se preporučuje svaka 3 mjeseca.

Čišćenje filtera na pumpi za odvod vode

⚠ Pozornost!

Obratiti pozornost na vruću vodu koja može preostati nakon pranja. Zbog toga je potrebno pričekati kako bi se smjesa otpadne vode i deterdženta ohladila. Prije početka čišćenja, potrebno je isključiti aparat iz električne mreže (opasnost od električnog udara) te zatvoriti dovod vode.

Filter treba redovito čistiti (svaka 3 mjeseca) kako bi se osigurao normalan rad aparata.

1. Otvoriti vratašca za pristup filteru

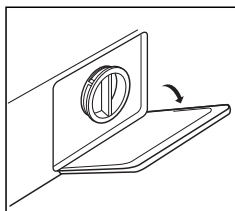

2. Otvoriti poklopac s filterom okretanjem obrnuto od smjera kazaljke na satu

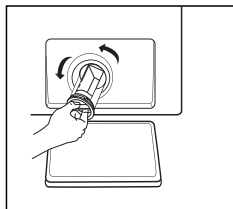

3. Izbaciti strane objekte i ostatke

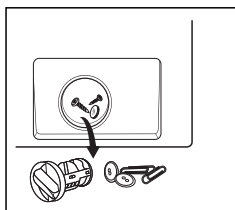

4. Vratiti filter na mjesto i zatvoriti ga, te zatvoriti vratašca za pristup

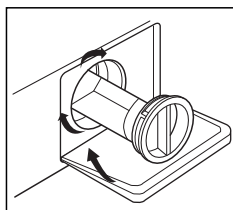

Pozornost!

Nakon okretanja i vađenja poklopca s filterom, voda će direktno istjecati iz komore pa je treba prihvatiti u neku posudu, ili na krpu.

Tijekom izvođenja odgovarajućeg programa, u pumpi može biti vruće vode.

Nije dozvoljeno otvaranje poklopca s filterom tijekom rada aparata, nego tek kada se program kompletno izvrši, aparat ohladi, isprazni, te isključi.

Uvjerite se kako je poklopac dobro pritegnut i siguran.

Problemi te njihovo moguće uklanjanje

POZORNOST!

Samo stručno osposobljeno servisno osoblje, iz ovlaštenog servisa, smije obavljati popravke.



Ukoliko Vaš aparat ne radi ispravno, uzrok bi mogla biti neka sitnica.

Kako biste uštedjeli vrijeme i novac prije pozivanja servisera, provjerite sljedeće:

Opis	Razlog	Moguće rješenje
Aparat se ne može startati	Vrata aparata nisu zatvorena Odjeća se zaglavila	Zatvoriti vrata i ponovo startati aparat Provjeriti da li se zaglavila odjeća
Vrata aparata se ne mogu otvoriti	Sigurnosna brava na vratima je uključena	Isključiti aparat sa električne mreže te ponovno startati aparat
Curenje vode	Priključak dovoda vode ili ispusta vode nije stegnut	Provjeriti i pritegnuti priključak na vodu Očistiti crijevo za ispušt vode
Ostaci deterdženta u ladici	Deterdžent je vlažan ili u grudicama	Očistiti, oprati i obrisati ladicu za deterdžent
Signalno svjetlo ili display ne svijetli	Prekid u napajanju upravljačke ploče ili spojeva	Provjeriti da li je došlo do prekida u električnoj mreži te da li je priključak pravilno priključen na električnu mrežu
Prevelika buka	Transportne blokade. Pod nije čvrst i ravan.	Provjeriti da li su transportne blokade uklonjene Provjeriti da li je aparat postavljen na čvrstu i ravnu podlogu te niveliran

Kod na displayu	Razlog	Moguće rješenje
<i>E30</i>	Vrata aparata nisu zatvorena	Zatvoriti vrata i ponovo startati program Provjeriti da li se zaglavila odjeća
<i>E10</i>	Problemi s ubrizgavanjem vode tijekom pranja	Provjeriti da li je tlak vode prenizak Provjeriti da li je crijevo za ulaz vode presavijeno, prignječeno ili blokirano Provjeriti da li je filter za ulaz vode začepljen
<i>E21</i>	Predugo pražnjenje vode	Provjeriti da li je crijevo za izlaz vode blokirano
<i>E12</i>	Procurivanje vode	Ponovo startati aparat
<i>EXX</i>	Ostalo	Pokušati ponovo startati aparat, a ako se greška i dalje pojavljuje tada pozvati ovlaštenu servis.

Ukoliko predložena rješenja ne uklone problem tada isključite aparat, izvadite utikač iz utičnice, zatvorite dovod vode te pozovite ovlaštenu servis.

Kolebanja u električnoj mreži

Ponekad se događaju velike promjene napona u mreži ili čak vrlo brzi i kratki prekidi napona u mreži (dijelić sekunde ili do sekundu-dvije). Ta pojava može uzrokovati prekid rada elektronike u aparatu. U tom slučaju isključite aparat iz mreže, pričekajte nekoliko minuta, uključite sapatat te ponovo pokrenite program. Ako to rješenje ne pomogne tada se obratite ovlaštenom sevisu.

Informacije o prijevozu

Odspojiti aparat s električne mreže, zatvoriti pipu za vodu. Odspojiti crijevo za dovod i odvod vode, isprazniti vodu iz bubnja preko filtera pumpe (vidjeti poglavlje prije), očistiti aparat, provjeriti da li su zatvorena vrata bubnja i ladica za deterdžent, staviti 4 transportne blokade.

Ako je moguće, sačuvajte originalnu ambalažu i proizvod uvijek prevozite u originalnoj ambalaži. Pridržavajte se znakova i uputa za prijevoz na kutiji.

Ako nemate originalnu kutiju tada poduzmite potrebne mjere za zaštitu vanjskih površina (staklenih, plastičnih i obojenih površina) aparata od udaraca.

Aparat je težak pa ga je potrebno pažljivo prenositi i podizati. Nikada ga ne podizati držeći za ručku ili vrata ili druge dijelove.

Nakon transporta, aparat se mora ponovno postaviti i priključiti u skladu s uputama.

Ako se aparat premješta na drugo mjesto (lokaciju)

1. Ponovno instalirati transportne blokade (od strane kvalificirane osobe).
2. Isprazniti zaostalu vodu iz bubnja.
3. Pažljivo prenositi aparat. Nikada ga ne podizati držeći za ručku ili vrata ili druge dijelove.
4. Aparat je težak te ga treba pažljivo prenositi.

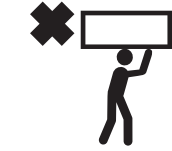
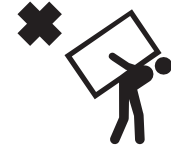
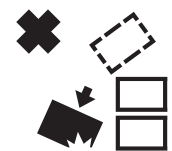
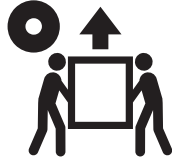
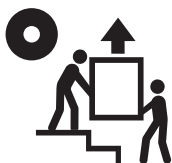

Informacijski list proizvoda

Delegirana uredba Komisije (EU) 2019/2014 u pogledu označavanja energetske učinkovitosti kućanskih perilica rublja i kućanskih perilica-sušilica rublja

Ime ili zaštitni znak dobavljača: KONČAR

Adresa dobavljača: KONČAR - KUĆANSKI APARATI d.d., Karlovačka 23, 10451 Pisarovina, Hrvatska

Identifikacijska oznaka modela: PR127MG17INV

Glavni parametri proizvoda:

Parametar	Vrijednost		Parametar	Vrijednost	
Nazivni kapacitet ^(a) (kg)	7.0		Dimenzije u centimetrima	Visina	85
				Širina	60
				Dubina	40
Indeks energetske učinkovitosti EEL _W ^(a)	51.5		Razred energetske učinkovitosti ^(a)	A	
Indeks učinkovitosti pranja ^(a)	1.031		Učinkovitost ispiranja ^(a) (g/kg)	5.0	
Potrošnja energije u kWh po ciklusu, na temelju programa eco 40-60. Stvarna potrošnja energije ovisit će tome kako se uređaj koristi.	0.444		Potrošnja vode u litrama po ciklusu, na temelju programa eco 40-60. Stvarna potrošnja vode ovisit će o tome kako se uređaj koristi i o tvrdoći vode.	45	
Najviša temperatura u obrađenom tekstilu ^(a) (°C)	Nazivni kapacitet	37	Preostali sadržaj vlage ^(a) (%)	62.9	
	Polovina	33			
	Četvrtina	23			
Brzina centrifugiranja ^(a) (okr./min)	Nazivni kapacitet	1200	Razred učinkovitosti centrifugiranja ^(a)	C	
	Polovina	1200			
	Četvrtina	1200			
Trajanje programa ^(a) (h:min)	Nazivni kapacitet	3:28	Vrsta	samostojeći	
	Polovina	2:42			
	Četvrtina	2:42			
Emisija buke koja se prenosi zrakom u fazi centrifugiranja ^(a) (dB(A) re 1 pW)	72		Razred emisije buke koja se prenosi zrakom ^(a) (faza centrifugiranja)	A	
Isključeno stanje (W)	0.50		Stanje pripravnosti (W)	1,00	
Odgodeni početak rada (W) (ako je primjenjivo)	4.00		Umreženi odgodeni početak rada (W) (ako je primjenjivo)	-	

Minimalno trajanje jamstva koje nudi proizvođač: 60 mjeseci

Ovaj je proizvod projektiran za ispuštanje iona srebra tijekom ciklusa pranja:

NE

Dodatne informacije:

Poveznica na internetsku stranicu proizvođača: www.koncar-ka.hr

(a) za program eco 40 – 60.

Informacijski list proizvoda

Delegirana uredba Komisije (EU) 2019/2014 u pogledu označavanja energetske učinkovitosti kućanskih perilica rublja i kućanskih perilica-sušilica rublja

Ime ili zaštitni znak dobavljača: KONČAR

Adresa dobavljača: KONČAR - KUĆANSKI APARATI d.d., Karlovačka 23, 10451 Pisarovina, Hrvatska

Identifikacijska oznaka modela: PR148MG17INV

Glavni parametri proizvoda:

Parametar	Vrijednost		Parametar	Vrijednost	
Nazivni kapacitet ^(a) (kg)	8.0		Dimenzije u centimetrima	Visina	85
				Širina	60
				Dubina	47
Indeks energetske učinkovitosti EEL _W ^(a)	51.9		Razred energetske učinkovitosti ^(a)	A	
Indeks učinkovitosti pranja ^(a)	1.031		Učinkovitost ispiranja ^(a) (g/kg)	5.0	
Potrošnja energije u kWh po ciklusu, na temelju programa eco 40-60. Stvarna potrošnja energije ovisit će tome kako se uređaj koristi.	0.472		Potrošnja vode u litrama po ciklusu, na temelju programa eco 40-60. Stvarna potrošnja vode ovisit će o tome kako se uređaj koristi i o tvrdoći vode.	48	
Najviša temperatura u obrađenom tekstilu ^(a) (°C)	Nazivni kapacitet	33	Preostali sadržaj vlage ^(a) (%)	53.9	
	Polovina	28			
	Četvrtina	24			
Brzina centrifugiranja ^(a) (okr./min)	Nazivni kapacitet	1350	Razred učinkovitosti centrifugiranja ^(a)	B	
	Polovina	1350			
	Četvrtina	1350			
Trajanje programa ^(a) (h:min)	Nazivni kapacitet	3:38	Vrsta	samostojeći	
	Polovina	2:48			
	Četvrtina	2:48			
Emisija buke koja se prenosi zrakom u fazi centrifugiranja ^(a) (dB(A) re 1 pW)	72		Razred emisije buke koja se prenosi zrakom ^(a) (faza centrifugiranja)	A	
Isključeno stanje (W)	0.50		Stanje pripravnosti (W)	-	
Odgođeni početak rada (W) (ako je primjenjivo)	4.00		Umreženi odgođeni početak rada (W) (ako je primjenjivo)	-	

Minimalno trajanje jamstva koje nudi proizvođač: 60 mjeseci

Ovaj je proizvod projektiran za ispuštanje iona srebra tijekom ciklusa pranja:	NE
--	----

Dodatne informacije:

Poveznica na internetsku stranicu proizvođača: www.koncar-ka.hr

(a) za program eco 40 – 60.

Informacijski list proizvoda

Delegirana uredba Komisije (EU) 2019/2014 u pogledu označavanja energetske učinkovitosti kućanskih perilica rublja i kućanskih perilica-sušilica rublja

Ime ili zaštitni znak dobavljača: KONČAR

Adresa dobavljača: KONČAR - KUĆANSKI APARATI d.d., Karlovačka 23, 10451 Pisarovina, Hrvatska

Identifikacijska oznaka modela: PR149MG17INV

Glavni parametri proizvoda:

Parametar	Vrijednost		Parametar	Vrijednost	
Nazivni kapacitet ^(a) (kg)	9,0		Dimenzije u centimetrima	Visina	85
				Širina	60
				Dubina	53
Indeks energetske učinkovitosti EEL _W ^(a)	51.9		Razred energetske učinkovitosti ^(a)	A	
Indeks učinkovitosti pranja ^(a)	1.031		Učinkovitost ispiranja ^(a) (g/kg)	5.0	
Potrošnja energije u kWh po ciklusu, na temelju programa eco 40-60. Stvarna potrošnja energije ovisit će tome kako se uređaj koristi.	0.494		Potrošnja vode u litrama po ciklusu, na temelju programa eco 40-60. Stvarna potrošnja vode ovisit će o tome kako se uređaj koristi i o tvrdoći vode.	50	
Najviša temperatura u obrađenom tekstilu ^(a) (°C)	Nazivni kapacitet	36	Preostali sadržaj vlage ^(a) (%)	53.9	
	Polovina	32			
	Četvrtina	25			
Brzina centrifugiranja ^(a) (okr./min)	Nazivni kapacitet	1350	Razred učinkovitosti centrifugiranja ^(a)	B	
	Polovina	1350			
	Četvrtina	1350			
Trajanje programa ^(a) (h:min)	Nazivni kapacitet	3:48	Vrsta	samostojeći	
	Polovina	2:54			
	Četvrtina	2:54			
Emisija buke koja se prenosi zrakom u fazi centrifugiranja ^(a) (dB(A) re 1 pW)	72		Razred emisije buke koja se prenosi zrakom ^(a) (faza centrifugiranja)	A	
Isključeno stanje (W)	0.50		Stanje pripravnosti (W)	-	
Odgođeni početak rada (W) (ako je primjenjivo)	4.00		Umreženi odgođeni početak rada (W) (ako je primjenjivo)	-	

Minimalno trajanje jamstva koje nudi proizvođač: 60 mjeseci

Ovaj je proizvod projektiran za ispuštanje iona srebra tijekom ciklusa pranja:

NE

Dodatne informacije:

Poveznica na internetsku stranicu proizvođača: www.koncar-ka.hr

(a) za program eco 40 – 60.

Informacijski list proizvoda

Delegirana uredba Komisije (EU) 2019/2014 u pogledu označivanja energetske učinkovitosti kućanskih perilica rublja i kućanskih perilica-sušilica rublja

Ime ili zaštitni znak dobavljača: KONČAR

Adresa dobavljača: KONČAR - KUĆANSKI APARATI d.d., Karlovačka 23, 10451 Pisarovina, Hrvatska

Identifikacijska oznaka modela: PR1410MG17INV

Glavni parametri proizvoda:

Parametar	Vrijednost		Parametar	Vrijednost	
Nazivni kapacitet ^(a) (kg)	10.0		Dimenzije u centimetrima	Visina	85
				Širina	60
				Dubina	53
Indeks energetske učinkovitosti EEL _W ^(a)	51.9		Razred energetske učinkovitosti ^(a)	A	
Indeks učinkovitosti pranja ^(a)	1.031		Učinkovitost ispiranja ^(a) (g/kg)	5.0	
Potrošnja energije u kWh po ciklusu, na temelju programa eco 40-60. Stvarna potrošnja energije ovisit će tome kako se uređaj koristi.	0.513		Potrošnja vode u litrama po ciklusu, na temelju programa eco 40-60. Stvarna potrošnja vode ovisit će o tome kako se uređaj koristi i o tvrdoći vode.	52	
Najviša temperatura u obrađenom tekstilu ^(a) (°C)	Nazivni kapacitet	37	Preostali sadržaj vlage ^(a) (%)	53.9	
	Polovina	33			
	Četvrtina	23			
Brzina centrifugiranja ^(a) (okr./min)	Nazivni kapacitet	1350	Razred učinkovitosti centrifugiranja ^(a)	B	
	Polovina	1350			
	Četvrtina	1350			
Trajanje programa ^(a) (h:min)	Nazivni kapacitet	3:59	Vrsta	samostojeći	
	Polovina	3:00			
	Četvrtina	3:00			
Emisija buke koja se prenosi zrakom u fazi centrifugiranja ^(a) (dB(A) re 1 pW)	72		Razred emisije buke koja se prenosi zrakom ^(a) (faza centrifugiranja)	A	
Isključeno stanje (W)	0.50		Stanje pripravnosti (W)	-	
Odgodeni početak rada (W) (ako je primjenjivo)	4.00		Umreženi odgodeni početak rada (W) (ako je primjenjivo)	-	

Minimalno trajanje jamstva koje nudi proizvođač: 60 mjeseci

Ovaj je proizvod projektiran za ispuštanje iona srebra tijekom ciklusa pranja:	NE
--	----

Dodatne informacije:

Poveznica na internetsku stranicu proizvođača: www.koncar-ka.hr

(a) za program eco 40 – 60.

Washing Machine

USER MANUAL

Warning notices: Before using this product, please read this manual carefully and keep it for future reference. The design and specifications are subject to change without prior notice for product improvement. Consult with your dealer or manufacturer for details. The diagram above is just for reference. Please take the appearance of the actual product as the standard.

THANK YOU LETTER

Before using your new product, please read this manual thoroughly to ensure that you know how to operate the features and functions that your new appliance offers in a safe way.

CONTENTS

THANK YOU LETTER	01
SAFETY INSTRUCTIONS	02
SPECIFICATIONS	06
PRODUCT OVERVIEW	07
QUICK START GUIDE	08
PRODUCT INSTALLATION	11
OPERATION INSTRUCTIONS	15
CLEANING AND MAINTENANCE	34
TROUBLE SHOOTING	38
DISPOSAL AND RECYCLING	39



Read all instructions and explanations before use. Follow the instructions carefully. Keep the operation instructions handy for later use. If the appliance is sold or passed on then ensure that the new owner always receives these operation instructions.

SAFETY INSTRUCTIONS

Intended Use







The product is intended only for home use and for textiles in household amounts suitable for washing. This appliance is for indoor use only and not intended for built in use. Only use according to these instructions. The appliance is not intended for commercial use.

Any other use is considered as improper use. The producer is not responsible for any damage or injury that may result from it.

This appliance is intended to be used in household and similar applications such as:

- Staff kitchen areas in shops, offices and other working environments;
- Farm houses;
- By clients in hotels, motels and other residential type environments;
- Bed and breakfast type environments;
- Areas for communal use in blocks of flats or in launderettes.

Explanation of Symbols

	DANGER This symbol indicates that there are dangers to the life and health of persons due to extremely flammable gas.
	WARNING OF ELECTRICAL VOLTAGE This symbol indicates that there is a danger to life and health of persons due to voltage.
	WARNING The signal word indicates a hazard with a medium level of risk which, if not avoided, may result in death or serious injury.
	CAUTION The signal word indicates a hazard with a low degree of risk which, if not avoided, may result in minor or moderate injury.
	NOTE The signal word indicates important information (e.g. damage to property), but not danger.
	OBSERVE INSTRUCTIONS This symbol indicates that a service technician should only operate and maintain this appliance in accordance with the operating instructions.

Please read the following safety information thoroughly and follow it strictly to minimize the risk of fire or explosion, electric shock and to prevent property damage, personal injury or loss of life. Failing to follow these instructions shall void any warranty.

This appliance is not intended for use by persons (including children) with reduced physical, sensory or mental capabilities, or lack of experience and knowledge, unless they have been given supervision or instruction concerning use of the appliance by a person responsible for their safety.

WARNING: Electric Shock Hazard

- If the supply cord is damaged, it must be replaced by the manufacturer, its service agent or similarly qualified persons in order to avoid a hazard.
- If the machine is damaged, it must not be operated unless repaired by the manufacturer, its service agent or similarly qualified persons.
- Risk of electric shock!
- The appliance can be used by children aged from 8 years and above and persons with reduced physical, sensory or mental capabilities or lack of experience and knowledge if they have been given supervision or instruction concerning use of the appliance in a safe way and understand the hazards involved. Children shall not play with the appliance. Cleaning and user maintenance shall not be made by children without supervision.
- Children should be supervised that they do not play with the appliance.
- Children 3 years and under shall be kept away from the appliance or continuously supervised.
- Animals and children may climb into the machine. Check the machine before every operation.
- Do not climb or sit on the appliance.

Installation Location and Surrounding

- All washing and additional substances are to be kept in a safe place out of the reach of children.
- Do not install the machine on a carpet floor.
- The obstruction of the openings by a carpet can damage the machine.
- Keep the appliance clear from heating sources and direct sunlight to avoid plastic and rubber parts to corrode.
- Do not use the appliance in humid environments or rooms containing explosive or caustic gas. In case of water leakage or water splashes, let the appliance dry in the open air.
- The appliance must not be installed behind a lockable door, a sliding door or a door with a hinge on the opposite side to that of the machine .
- Do not operate the machine in rooms with a temperature of below 5°C. This can cause damages to parts of it. If it is unavoidable, make sure to drain the water completely from the appliance after every use (see“Maintenance - Cleaning of drain pump filter”) to avoid damages caused by frost.
- Never use flammable sprays or substances in the immediate proximity of the appliance.

Installation

- Remove all packaging material and transport bolts before using the appliance. Otherwise, serious damage may result.
- This appliance is equipped with a single inlet valve and can be connected to the cold water supply only.
- Mains plug must be accessible after installation.
- Before washing clothes for the first time, the product shall be operated once throughout all the procedures without any clothes inside.
- Before using the machine, the product shall be calibrated.
- Do not put any excessively heavy objects on the appliance, like water containers or heating devices.

SAFETY INSTRUCTIONS

- The new hose-sets supplied with the appliance are to be used and that old hose-sets should not be reused.
- Max. Inlet water pressure 1 MPa. Min. inlet water pressure 0.05 MPa.

Electrical Connection

- Make sure the supply cable is not trapped by the machine, or it can get damaged.
- Connect the product to a grounded outlet protected by a fuse complying with the values in the "Technical specifications" table. The grounding installation has to be made by a qualified electrician. Ensure that the machine is installed in accordance with the local regulations.
- Water and electrical connections must be carried out by a qualified technician in accordance with the manufacturer's instructions and local safety regulations.



WARNING:

- Don't use multiple plugs or extension cords.
- The appliance must not have an external switching device such as a timer or connected to a circuit that is regularly switched on and off.
- Do not pull the plug out of the mains outlet if there is flammable gas around.
- Never pull out power plug with wet hands.
- Always pull at the plug, not at the cable.
- Always unplug the appliance if it is not being used.

Water Connections

- Check the connections of the water inlet tubes, the water tap and the outlet hose for possible problems due to changes of water pressure. If the connections loosen or leak, close the water tap and get it repaired.
- Do not use the appliance before the pipes and hoses are installed properly by qualified persons.
- Glass door may become very hot during the operation. Keep children and pets far away from the machine while it is operating.
- The water inlet and outlet hoses have to be safely installed and remain undamaged.
- Otherwise, water leakage can occur.
- Do not remove the drain pump filter while there is still water in the appliance. Big quantities of water can leak out, and there is a risk of scalding due to hot water.

Operation and Maintenance

- Never use any flammable, explosive or toxic solvents. Do not use gasoline and alcohol etc. as detergents. Only select detergents that are suitable for machine washing.
- Make sure that all pockets are emptied. Sharp and rigid items such as coins, brooches, nails, screws, stones etc. may cause serious damages to this machine.
- Remove all objects from pockets such as lighters and matches before use the appliance. Thoroughly rinse items that have been washed by hand.

- Items that have been soiled with substances such as cooking oil, acetone, alcohol, petrol, kerosene, spot removers, turpentine, wax and wax removers should be washed in hot with an extra amount of detergent before being dried in the appliance.
- Items containing foam rubber (latex foam), shower caps, water proof textiles, rubber backed articles and clothes or pillows fitted with foam rubber pads should not be washed in the machine.
- Fabric softeners or similar products should be used as recommended in their instructions.
- Never try to open the door forcefully.
- The door will unlock shortly after the end of a cycle.
- Please do not close the door with excessive force. If it is found difficult to close the door, please check if the clothes are properly inserted and distributed.
- Always unplug the appliance and close the water tap before cleaning and maintenance and after each use.
- Never pour water over the appliance for cleaning purpose. Risk of electric shock!
- Repairs shall only be carried out by the manufacturer, its service agent or similarly qualified persons in order to avoid a hazard.
- The producer will not be responsible for damages caused by the intervention of not authorized persons.

Transport

- Before Transport:
 - Bolts shall be reinstalled to the machine by a specialized person;
 - Accumulated water shall be drained out of the machine.
- This appliance is heavy. Transport with care. Never hold any protruding part of the machine when lifting. The machine door can not be used as a handle.

SPECIFICATIONS

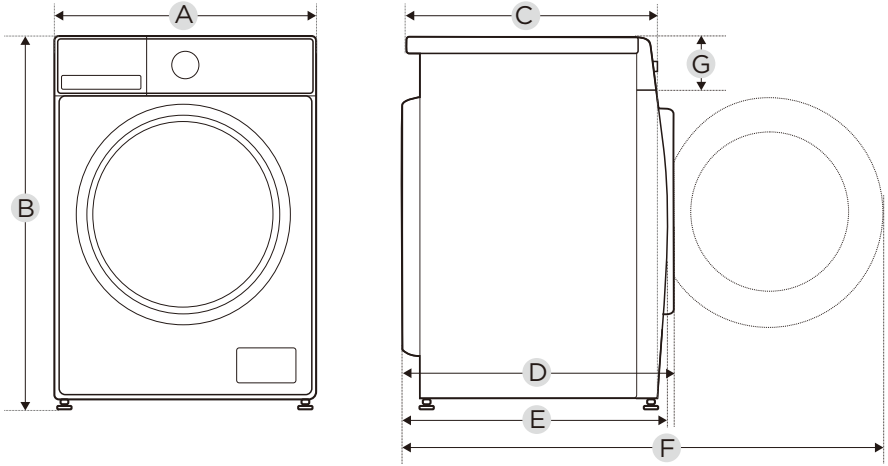

Model				
Power Supply	220-240V~,50Hz			
MAX. Current	10A			
Standard Water Pressure	0.05MPa~1MPa			
Washing Capacity	7.0kg	8.0kg	9.0kg	10.0kg
Dimension				
A	595mm	595mm	595mm	595mm
B	850mm	850mm	850mm	850mm
C	400mm	470mm	530mm	530mm
Weight	57kg	63kg	65kg	65kg
Rated Power	2000W	2000W	2000W	2000W
Reference Dimension				
D	470mm	540mm	600mm	600mm
E	445mm	521mm	540mm	540mm
F	935mm	985mm	1045mm	1045mm
G	135mm	135mm	135mm	135mm

PRODUCT OVERVIEW

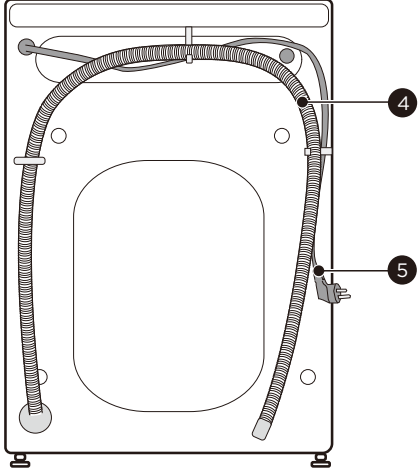
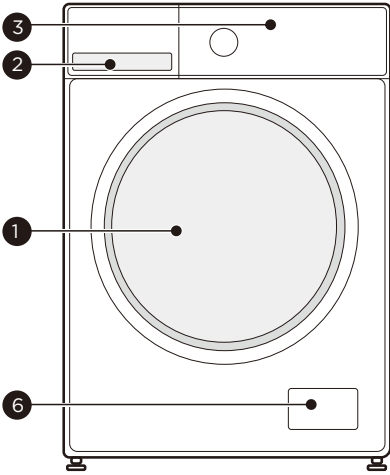

1	Door
2	Detergent dispenser
3	Control panel

4	Drain hose
5	Power supply cord
6	Service flap

NOTE

The product picture is for illustration only, please refer to real product as reference.

Accessories

4 x Cover caps

1 x Supply hose cold water

1 x Owner's manual

Acoustic sponge (optional)

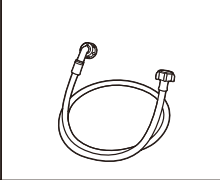
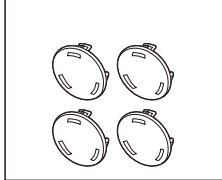

QUICK START GUIDE

CAUTION

- Before washing, please make sure the machine is installed properly.
- Your appliance was thoroughly checked before it left the factory. To remove any residual water and to neutralize potential odors, it's recommended to clean your appliance before first use. For this reason, it's recommended to clean the inner drum by running the "Drum Clean" or other program with the optional temperature of 90°C. Be careful not to put laundry and detergent in the machine.

Calibration

It's recommended to calibrate the machine, so that provide the best performance. The appliance is able to detect the amount of laundry loaded. This function is optimizing the product performance by minimizing energy and water consumption, saving you money and time. For this reason it's recommended to calibrate the appliance for best use.

- 1- Remove all accessories from the drum and close the door;
- 2- Insert the mains plug to the socket;
- 3- Switch on the washing machine, and within 10 seconds, press "Speed" continuously (normally 3 seconds) until "t19" is displayed on the knob.
- 4- Press  to start the appliance, initially "---" is displayed, and then "****" (such as "126") is displayed to indicate the real time drum speed. When the number reaches a certain value (stop changing), it means the washing machine is successfully calibrated.

1. Before Washing

1. Plug in

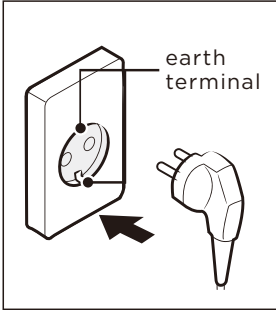

2. Open tap

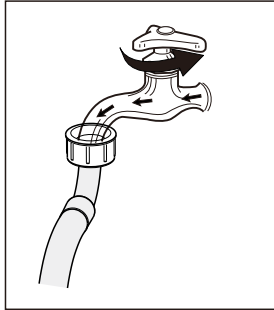

3. Load

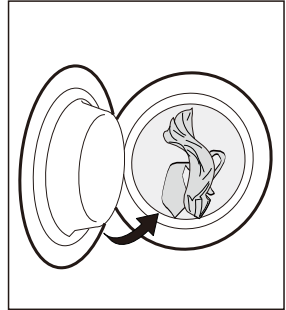

4. Close door

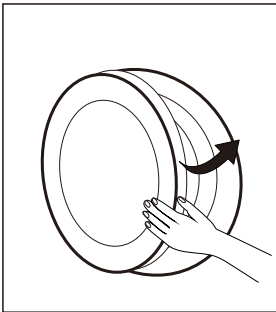

5. Add detergent

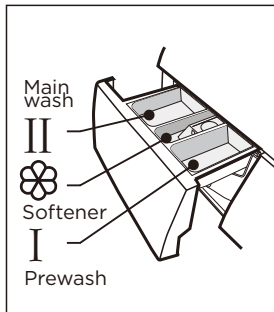

NOTE

Detergent need to be added in compartment I if the pre-wash function is selected.

2. Washing

1. Select programme

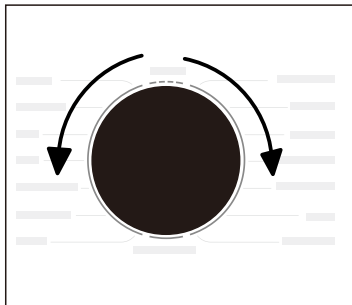

2. Select function or remain default settings

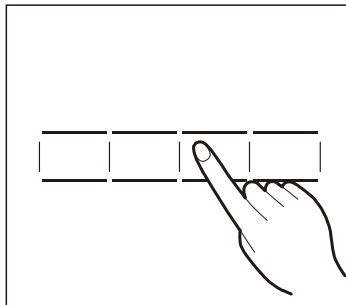

3. Press Start/Pause to start the program

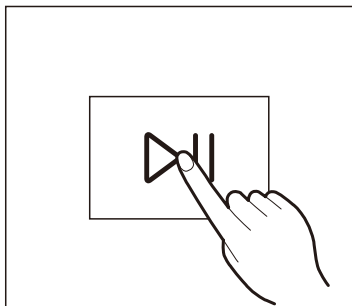

NOTE

1 : If default is selected, step 2 can be skipped.

2: The function button line chart is for reference only, please refer to real product as standard.

3. After Washing

Buzzer beep and “End” on display.

PRODUCT INSTALLATION

Tools Needed If Installation By Yourself (not include)

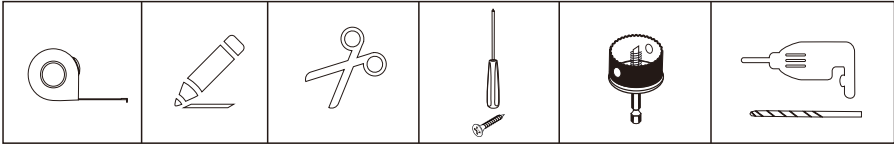

Installation Area

WARNING

- Stability is important to prevent the product from wandering!
- Make sure the machine is standing leveled and stable.
- Make sure that the product does not stand onto the power cord.
- Make sure to maintain the minimum distances from the walls as shown in the picture.

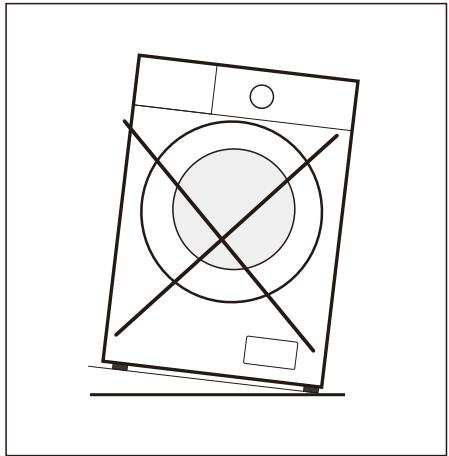
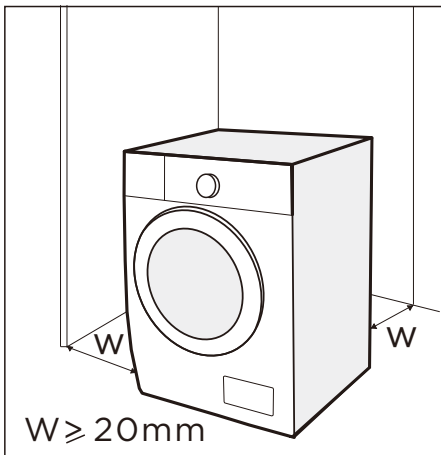

Before installing the machine, the location characterized as follows shall be selected:

1. Rigid, dry, and level surface.
2. Avoid direct sunlight.
3. Sufficient ventilation.
4. Room temperature is above 5 °C .
5. Keep far away from the heat sources such as coal or gas burning appliances.

Unpacking the Machine

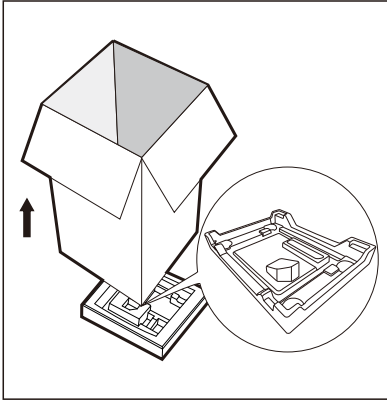

⚠ WARNING

- Packaging material (e.g. Films, Styrofoam) can be dangerous for children.
- There is a risk of suffocation ! Keep all packaging well away from children.

1. Remove the cardboard box and styrofoam packing.
2. Lift the machine and remove the base packaging.
3. Remove the tape securing the power supply cord and drain hose.
4. Remove the inlet hose from the drum.

Remove Transport Bolts

⚠ WARNING

You must remove the transport bolts from the backside before using the product.

1. Loosen the 4 transport bolts with a spanner.

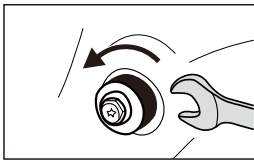

2. Remove the bolts including the rubber parts and keep them for future use.

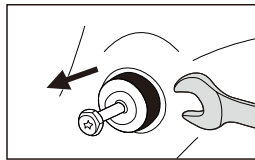

3. Close the holes using the cover caps.

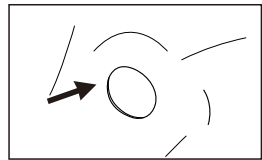

PRODUCT INSTALLATION

Levelling the Machine

⚠ WARNING

The lock nuts on all four feet must be screwed tightly against the housing.

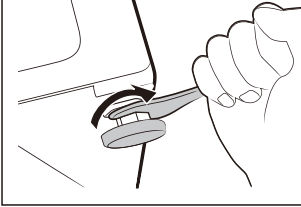

1. Loosen the lock nut.
2. Turn the foot until it reaches the floor.
3. Adjust the legs and lock the nuts with a spanner. Make sure the machine is level using a spirit level.

Connect the Water Supply Hose

⚠ WARNING

To prevent leakage or water damage, follow the instructions in this chapter.

- Do not kink, crush or modify water inlet hose.

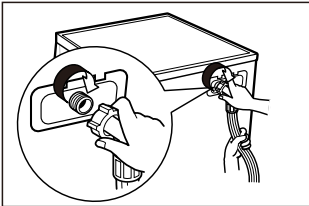

Connect the water supply hose to the water inlet valve and a water tap with cold water as indicated.

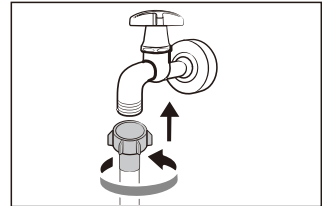

● NOTE

- Connect manually, do not use tools. Check if the connections are tight.

Drain Hose

⚠ WARNING

- Do not kink or protract the drain hose.
- Position drain hose properly ,otherwise damage might result in water leakage.
- It is not allowed to remove the buckle of drain pipe.

There are two ways to place the end of drain hose:

1. Put it into the water trough.

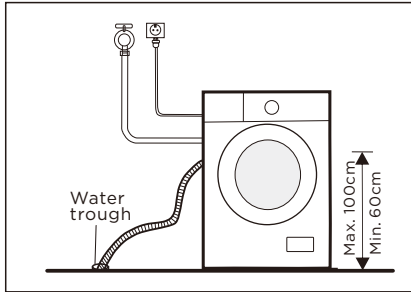

2. Connect it to the branch drain pipe of the trough.

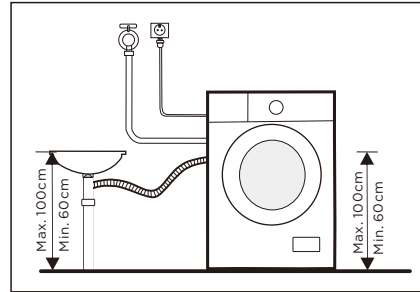

Acoustic Sponge

NOTE

- Please make sure to assemble the acoustic sponges, which can effectively reduce the noise caused by the machine while working, in order to provide you with a more peaceful and quiet living environment.

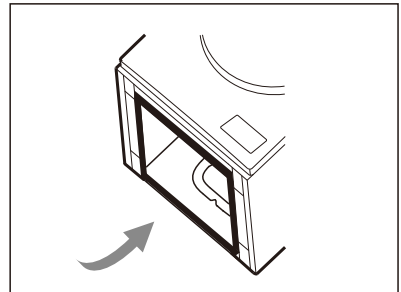
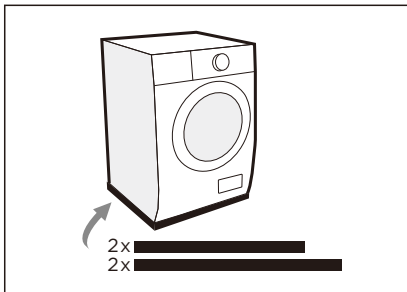

1. Get the machine laid on the floor, using some soft material like foam or clothes between the machine and floor for a protection;
2. Stick the 2x longer sponges to the longer bottom edges of machine, and the 2x shorter sponges to the shorter bottom edges.

OPERATION INSTRUCTIONS

Before Each Washing

- The ambient temperature of the machine should be 5°C-40°C. If used under 0°C, the inlet valve and draining system may be damaged. If the machine is installed under freezing conditions, it should be transferred to normal ambient temperature to ensure the water supply hose and drain hose can unfreeze before use.
- Please check your laundry care labels and the detergent use instructions before wash. Use non-foaming or less-foaming detergent suitable for machine properly.

1. Take all items out of the pockets

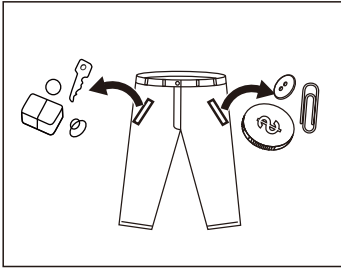

2. Sort laundry according to color and textile type

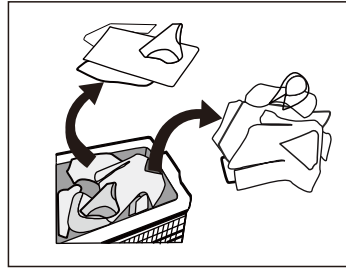

3. Tie together long textile strips and belts, close zips and button

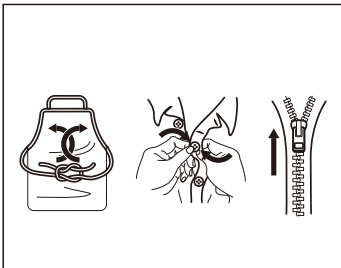

4. Put small items into a laundry bag

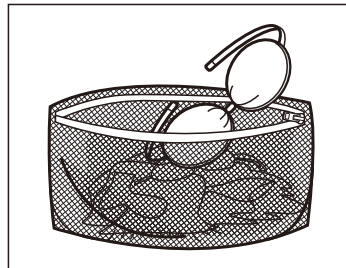

WARNING

- Do not wash or dry articles that have been cleaned in, washed in, soaked in, or dabbed with combustible or explosive substances like wax, oil, paint, gasoline, alcohol, kerosene, and other flammable materials.
- Washing single clothes items may easily create big eccentricity. Therefore it is suggested to add one or two more laundry items to the wash so that spin can be done smoothly.
- Do not wash, spin water-proof seats, mats ,or clothing.

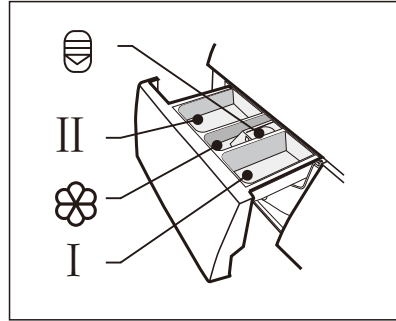

Detergent Dispenser

- I Pre wash
- II Main wash
- ☼ Softener
- ⊖ Release button to pull out the dispenser



⚠ CAUTION

- Detergent only need to be added in “compartment I ”after selecting pre-wash function.

Programme	I	II / 	☼	Programme	I	II / 	☼
Cotton	<input type="radio"/>	<input checked="" type="radio"/>	<input type="radio"/>	Spin Only			
Synthetic	<input type="radio"/>	<input checked="" type="radio"/>	<input type="radio"/>	Bulky	<input type="radio"/>	<input checked="" type="radio"/>	<input type="radio"/>
Mix	<input type="radio"/>	<input checked="" type="radio"/>	<input type="radio"/>	Wool		<input checked="" type="radio"/>	<input type="radio"/>
Sportswear	<input type="radio"/>	<input checked="" type="radio"/>	<input type="radio"/>	Quick 15'		<input checked="" type="radio"/>	<input type="radio"/>
Baby Care	<input type="radio"/>	<input checked="" type="radio"/>	<input type="radio"/>	Rapid 45'		<input checked="" type="radio"/>	<input type="radio"/>
Jeans	<input type="radio"/>	<input checked="" type="radio"/>	<input type="radio"/>	20°C		<input checked="" type="radio"/>	<input type="radio"/>
ECO 40-60		<input checked="" type="radio"/>	<input type="radio"/>	Steam Wash	<input type="radio"/>	<input checked="" type="radio"/>	<input type="radio"/>
Drum Clean							

- Means must
- Means optional

OPERATION INSTRUCTIONS

Detergent Recommendation

Recommended washing detergent	Type of laundry and textile	Wash cycles	Washing temp. ° C
Heavy-duty detergent with bleaching agents and optical brighteners	White laundry made from boil-proof cotton or linen	Cotton,ECO 40-60	40/60
Colour detergent without bleaching agent and optical brighteners	Coloured laundry made from cotton or linen	Cotton	20/40
Color or mild detergent without optical brighteners	Coloured laundry made from easy care fibres or synthetic materials	Cotton,Synthetic	20/40
Mild washing detergent	Delicate textiles, silk, viscose	Synthetic	20
Special wool detergent	Wool	Wool	20/40

NOTE

- Agglomerating or ropy detergent or additive can be diluted in some water before pouring it into the detergent dispenser, to avoid its inlet to get blocked and thus cause a water overflow.
- Please choose the suitable type of detergent to get a maximum of washing performance and a minimum of water and energy consumption.
- To achieve the best cleaning result a proper detergent dosing is important.
- Use a reduced detergent amount if the drum is not filled completely.
- Always adjust the amount of detergent to the water hardness, if your tap water is soft, use less detergent.
- Dose according to how dirty your laundry is, less dirty clothes require less detergent.
- Highly concentrated (compact detergent) requires particularly accurate dosing.

Following symptoms are a sign of detergent overdosing:

- heavy foam formation
- poor washing and rinsing result

Following symptoms are a sign of detergent under dosing:

- laundry turns grey
- built-up of limescale deposits on the drum, the heating element and/or the laundry

Control Panel

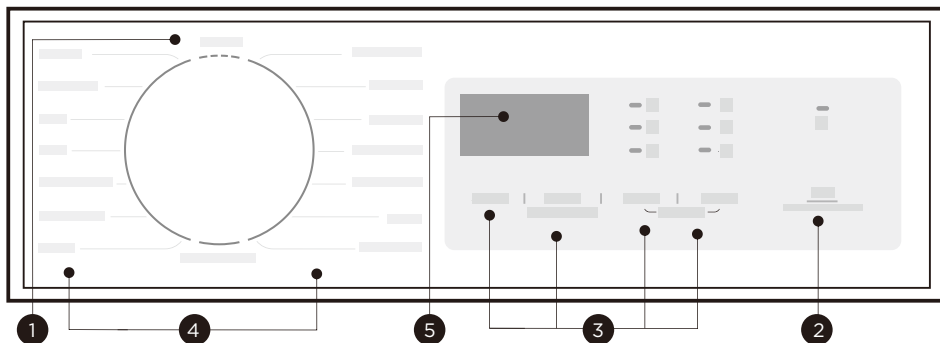

1 OFF

Turn the appliance off.

2 Start/Pause

Start or pause your programme.

3 Option

This allows you to select additional functions and will light when selected.

4 Programmes

Available according to the laundry type.

5 Display

The display shows settings, estimated remaining time, options and status messages.

NOTE

- The Chart is reference only, please refer to real product as standard.

OPERATION INSTRUCTIONS

Display

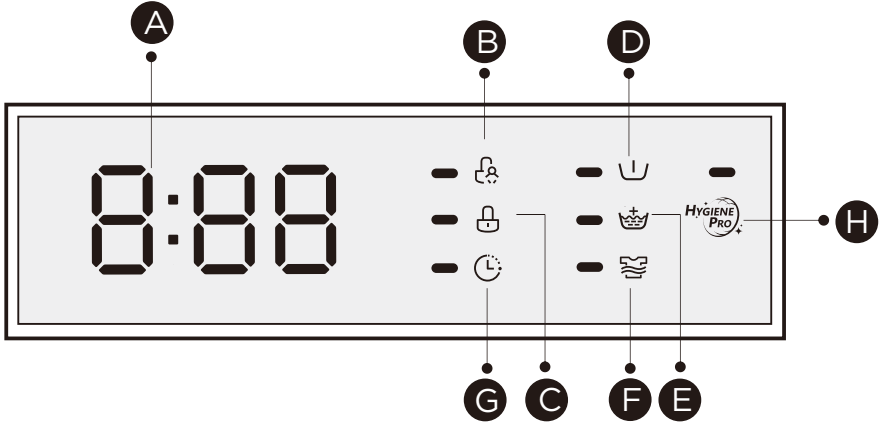

- A** Display
 - Wash Time
 - 125
 - Speed
 - 400
 - End
 - End
 - Delay Time
 - 2H
 - Error
 - E30
 - Temp.
 - 30
- B** Child Lock
- C** Door Lock
- D** Pre Wash
- E** Extra Rinse
- F** Strong Wash
- G** Delay
- H** HYGIENE PRO

Programmes

Programme	Load (kg)				Default Time (h:min)			
	7.0	8.0	9.0	10.0	7.0	8.0	9.0	10.0
Cotton	7.0	8.0	9.0	10.0	1:38	3:49	3:49	3:49
Synthetic	3.5	4.0	4.5	5.0	2:08	3:28	3:28	3:28
Mix	7.0	8.0	9.0	10.0	1:30	1:30	1:30	1:30
20°C	3.5	4.0	4.5	5.0	1:11	1:11	1:11	1:11
Sportswear	3.5	4.0	4.5	5.0	0:57	0:57	0:57	0:57
Baby Care	7.0	8.0	9.0	10.0	1:52	1:52	1:52	1:52
Jeans	7.0	8.0	9.0	10.0	1:56	1:56	1:56	1:56
Steam Wash	3.5	4.0	4.5	5.0	1:58	1:58	1:58	1:58
Spin Only	7.0	8.0	9.0	10.0	0:12	0:12	0:12	0:12
Bulky	7.0	8.0	9.0	10.0	1:48	1:48	1:48	1:48
Wool	2.0	2.0	2.0	2.0	1:07	1:07	1:07	1:07
ECO 40-60	7.0	8.0	9.0	10.0	3:28	3:38	3:48	3:59
Drum Clean	--	--	--	--	1:28	1:28	1:28	1:28
Quick 15'	2.0	2.0	2.0	2.0	0:15	0:15	0:15	0:15
Rapid 45'	2.0	2.0	2.0	2.0	0:45	0:45	0:45	0:45

NOTE

- The parameters in this table are only for user's reference. The actual parameters maybe different with the parameters in above mentioned table.

Programmes

Cycle	Nominal capacity in kg	Temperature setting °C	Cycle duration in hours and minutes	Energy consumption in kWh/operalling cycle	Water consumption in liter/operalling cycle	Highest temperature °C ⁽¹⁾	Residual moisture in % /spin speed in rpm ⁽²⁾
Cotton	7.0	40	1:38	0.727	65	40	70%/800
Mix	7.0	40	1:30	0.713	65	40	70%/800
20°C	3.5	20	1:11	0.194	41	20	65%/1000
Baby care	7.0	60	1:52	1.196	65	60	65%/1000
Quick 15'	2.0	Cold	0:15	0.030	31	Cold	70%/800
ECO 40-60 ⁽³⁾	7.0	--	3:28	0.670	52.0	37	62.9%/1200
	3.5	--	2:42	0.405	44.0	33	62.9%/1200
	2.0	--	2:42	0.167	36.0	23	62.9%/1200

- The above data is for reference only, and the data may change due to different actual use conditions.
- The valves given for programmes other than the ECO 40-60 programme are indicative only.
- 20°C is able to clean lightly soiled cotton laundry, at a nominal temperature of 20 °C, which complies with the regulation (EU) 2019/2023.
- Concerning to EN 60456:2016/A11:2020 With(EU) 2019/2014, (EU) 2019/2023, (EU) 2021/340, (EU) 2021/341,

The EU energy efficiency class is: A

Energy test program: ECO 40-60. Other as the default.

Half load for 7.0kg machine:3.5kg.

Quarter load for 7.0kg machine:2.0kg.

Programmes

Cycle	Nominal capacity in kg	Temperature setting °C	Cycle duration in hours and minutes	Energy consumption in kWh/operalling cycle	Water consumption in liter/operalling cycle	Highest temperature °C ⁽¹⁾	Residual moisture in % /spin speed in rpm ⁽²⁾
Cotton	8.0	60	3:54	1.515	71	60	53%/1400
Mix	8.0	40	1:30	0.772	71	40	70%/800
20°C	4.0	20	1:11	0.200	44	20	65%/1000
Quick 15'	2.0	Cold	0:15	0.030	31	Cold	70%/800
Bulky	8.0	40	1:48	0.803	71	40	65%/1000
ECO 40-60 ⁽³⁾	8.0	--	3:38	0.752	61.0	33	53.9%/1350
	4.0	--	2:48	0.412	45.0	28	53.9%/1350
	2.0	--	2:48	0.216	36.0	24	53.9%/1350

- The above data is for reference only, and the data may change due to different actual use conditions.
- The valves given for programmes other than the ECO 40-60 programme are indicative only.
- 20°C is able to clean lightly soiled cotton laundry, at a nominal temperature of 20 °C, which complies with the regulation (EU) 2019/2023.
- Concerning to EN 60456:2016/prA2019 With (EU)2019/2014, (EU)2019/2023, (EU)2021/340, (EU)2021/341

The EU energy efficiency class is: A

Energy test program: ECO 40-60. Other as the default.

Half load for 8.0kg machine:4.0kg.

Quarter load for 8.0kg machine:2.0kg.

Programmes

Cycle	Nominal capacity in kg	Temperature setting °C	Cycle duration in hours and minutes	Energy consumption in kWh/operalling cycle	Water consumption in liter/operalling cycle	Highest temperature °C ⁽¹⁾	Residual moisture in % /spin speed in rpm ⁽²⁾
Cotton	9.0	60	3:54	1.620	78	60	53%/1400
Mix	9.0	40	1:30	0.830	78	40	70%/800
20°C	4.5	20	1:11	0.206	48	20	65%/1000
Quick 15'	2.0	Cold	0:15	0.030	31	Cold	70%/800
Bulky	9.0	40	1:48	0.862	78	40	65%/1000
ECO 40-60 ⁽³⁾	9.0	--	3:48	0.808	67.0	36	53.9%/1350
	4.5	--	2:54	0.498	49.0	32	53.9%/1350
	2.5	--	2:54	0.225	36.0	25	53.9%/1350

- The above data is for reference only, and the data may change due to different actual use conditions.
- The valves given for programmes other than the ECO 40-60 programme are indicative only.
- 20°C is able to clean lightly soiled cotton laundry, at a nominal temperature of 20 °C, which complies with the regulation (EU) 2019/2023.
- Concerning to EN 60456:2016/prA2019 With (EU)2019/2014, (EU)2019/2023, (EU)2021/340, (EU)2021/341

The EU energy efficiency class is: A

Energy test program: ECO 40-60. Other as the default.

Half load for 9.0kg machine:4.5kg.

Quarter load for 9.0kg machine:2.5kg.

Programmes

Cycle	Nominal capacity in kg	Temperature setting °C	Cycle duration in hours and minutes	Energy consumption in kWh/operalling cycle	Water consumption in liter/operalling cycle	Highest temperature °C ⁽¹⁾	Residual moisture in % /spin speed in rpm ⁽²⁾
Cotton	10.0	60	3:54	1.726	85	60	53%/1400
Mix	10.0	40	1:30	0.889	85	40	70%/800
20°C	5.0	20	1:11	0.212	51	20	65%/1000
Quick 15'	2.0	Cold	0:15	0.030	31	Cold	70%/800
Bulky	10.0	40	1:48	0.920	85	40	65%/1000
ECO 40-60 ⁽³⁾	10.0	--	3:59	0.895	67.0	41	53.9%/1350
	5.0	--	3:00	0.560	52.0	33	53.9%/1350
	2.5	--	3:00	0.232	41.5	23	53.9%/1350

- The above data is for reference only, and the data may change due to different actual use conditions.
- The valves given for programmes other than the ECO 40-60 programme are indicative only.
- 20°C is able to clean lightly soiled cotton laundry, at a nominal temperature of 20 °C, which complies with the regulation (EU) 2019/2023.
- Concerning to EN 60456:2016/prA2019 With (EU)2019/2014, (EU)2019/2023, (EU)2021/340, (EU)2021/341

The EU energy efficiency class is: A

Energy test program: ECO 40-60. Other as the default.

Half load for 10.0kg machine:5.0kg.

Quarter load for 10.0kg machine:2.5kg.

Programmes

- 1) The highest temperature reached by the laundry in the wash cycle for at least 5 minutes.
- 2) Residual moisture after the wash cycle in water content percent and the spin speed at which this was achieved.
- 3) The ECO 40-60 programme is able to clean normally soiled cotton laundry declared to be washable at 40°C or 60°C, together in the same cycle. This programme is used to assess the compliance with the regulation (EU) 2019/2023.

The most efficient programmes in terms of energy consumption are generally those that perform at lower temperatures and longer duration.

Loading the household washing machine up to the capacity indicated for the respective programmes will contribute to energy and water savings.

Noise and remaining moisture content are influenced by the spinning speed: the higher the spinning speed in the spinning phase, the higher the noise and the lower the remaining moisture content.

CAUTION

- If there is any break in the power supply while the machine is operating, a special memory stores the selected programme. The machine will continue the programme when the power supply is re-established.

OPERATION INSTRUCTIONS

Programmes are available according to the laundry type.

Programmes	
Cotton	Hard-wearing textiles, heat-resistant textiles made of cotton or linen.
Rapid 45'	Washing few and not very dirty clothes quickly.
Synthetic	Wash synthetic articles, for example: shirts, coats, blending. While washing the knitting textiles, detergent quantity shall be reduced due to its loose string construction and easily forming bubbles.
Baby Care	Washing the baby's clothes, it can make the baby's wear cleaner. and make the rinse performance better to protect the baby skin.
Jeans	Specially for jeans.
Mix	Mixed load consisting of textiles made of cotton and synthetics.
20°C	Able to clean lightly soiled cotton laundry, at a nominal temperature of 20 °C.
Sportswear	Washing the activewear.
Quick 15'	Extra short programme approx, suitable for lightly soiled washing as a small amounts of laundry.
Bulky	This program is specially designed for washing Bulky.
Wool	Hand or machine-washable wool or richwool textiles. Especially gentle wash programme to prevent shrinkage, longer programme pauses (textiles rest in wash liquor).
Spin Only	Spins and drains the water.
ECO 40-60	Able to clean normally soiled cotton laundry declared to be washable at 40 °C or 60 °C, together in the same cycle.
Steam Wash	Steam is applicable for daily laundries.
Drum Clean	Specially set in this machine to clean the drum and tube. It applies 90 °C high temperature sterilization to make the clothes washing more green. When this programme is performed, the clothes or other washing cannot be added. When proper amount of chlorine bleaching agent is put in, the barrel cleaning effect will be better. The customer can use this programme regularly according to the need.

NOTE

- The Chart is reference only, please refer to real product as standard.
- When the programme is finished, "End" will flash on the display, Please select the knob to the Off position.

OPERATION INSTRUCTIONS

Option

Cycle	Default Temp.(°C)	Default spin speed (rpm)		Additional functions
		1200	1400	
Cotton	40	800	1400	🕒, 📏, 🧺, 🌀
Synthetic	40	800	1200	🕒, 📏, 🧺, 🌀
Mix	40	800	800	🕒, 📏, 🧺, 🌀
20°C	20	1000	1000	🕒, 🧺
Sportswear	20	800	800	🕒, 📏, 🧺
Baby Care	60	1000	1000	🕒, 📏, 🧺, 🌀
Jeans	60	800	800	🕒, 📏, 🧺
Drum Clean	90	--	--	🕒
Spin Only	--	1000	1000	🕒
Bulky	40	1000	1000	🕒, 📏, 🧺, 🌀
Wool	40	600	600	🕒, 🧺
ECO 40-60	--	1200	1400	🕒
Steam Wash	40	1000	1000	🕒, 📏, 🧺, 🌀
Quick 15'	Cold	800	800	🕒
Rapid 45'	20	800	800	🕒, 🧺

NOTE

- For the maximum spin speed, program time, and other details of the ECO 40-60 program, please refer to the content on the Product Fiche page.
- The table shows which cycle offers which options for adjustment. If an adjustment is not possible for a cycle.



Speed

When needed, the spinning speed can be adjusted pressing the Speed button in the following steps: 1400:0-400-600-800-1000-1200-1400



Delay

1. Select a programme.
2. Press the Delay button to choose the delaying time 0-24H.
3. Press [Start/Pause] to start the delay operation.



Choose programme



Setting time



Start

To cancel the Delay function, press the "Delay" button before starting the program until the display shows 0 H. If the program has already started, switch the appliance off and afterwards on and select a new programme.



Pre Wash

Extra washing function before the main washing cycle starts to increase the washing performance.

Note: Detergent needs to be added to the compartment I.



Extra Rinse

The laundry will undergo an extra rinse after selecting this function.



Strong Wash

Very dirty clothes can choose it, select it can increase the washing time and intensity to increase the washing effect.



HYGIENE PRO

When the Hygiene Pro light is on, this function is automatically activated in the program. The HYGIENE PRO function will be automatically activated during every washing cycle.

Hygiene Pro system will keep your laundry always clean.



Temp.

When needed, the washing temperature can be adjusted by pressing the temperature button in the following steps: Cold -20°C-30°C - 40°C- 60°C - 90°C.

NOTE

Usage counter

1. Unplug the equipment for 10s and reconnect again.
2. Power on and within 10s, please press "Speed" and "Funct." on control panel simultaneously and continuously for around 5s until the device display shows digits-- the value can indicate the times of equipment usage.
3. Repeat step 1 again and customer can resume to normal operation.

OPERATION INSTRUCTIONS



Child Lock
To avoid mis operation by children.



Press [Delay] and [Funct.] simultaneously for 3 sec until the buzzer beep. The child lock indicator switches on.



CAUTION

When the Child Lock is activated, the display will alternately show “CL” and the remaining time.

Pressing any other button will cause the Child Lock indicator to flash.

When the program ends, “CL” and “End” will alternate on the display.

The Child Lock deactivates the function of all buttons except the Child lock button!

Only the simultaneous pressing of the two buttons [Delay] and [Funct.] can deactivate the Child Lock!

Please deactivate the Child Lock before selecting a new program!



Mute the buzzer



Choose the Programme Press the [Temp.]button for 3sec.,
the buzzer is mute.

To act the buzzer function, press the button again for 3 seconds. The setting will be kept until the next reset.



CAUTION

- After Muting the buzzer function, the sounds will not be activated any more.
-



Reload

This operation can be executed during the washing progress. When the drum is still rolling and there is large amount of water with high temperature in the drum. The state is unsafe and the door cannot be opened forcefully. To Press [▶||] 3 sec. to reload, and start the clothes adding in the midway function. Please follow the steps as below:

1. Wait until the drum stops rotation.
2. The door lock is unlocked.
3. Close the door when the clothes are reloaded and press the [Start/Pause] button.



Press[Press 3 sec. to reload] 3 sec.

Reload the clothes

Start

Product Fiche

Supplier's name or trade mark^(*)(⁽¹⁾):

Supplier's address^(*)(⁽¹⁾):

Model identifier^(*): AJÜFI İ T ÖFİ Q XÁ

General product parameters:

Parameter	Value		Parameter	Value	
Rated capacity ^(b) (kg)	8.0		Dimensions in cm ^(b) (⁽²⁾)	Height	85
				Width	60
				Depth	47
Energy efficiency index ^(b) (EEI _w)	51.9		Energy efficiency class ^(b)	A (⁽⁴⁾)	
Washing efficiency index ^(b)	1.031		Rinsing effectiveness (g/kg) ^(b)	5.0	
Energy consumption in kWh per cycle, based on the eco 40-60 programme at a combination of full and partial loads. Actual energy consumption will depend on how the appliance is used.	0.472		Water consumption in litre per cycle, based on the eco 40-60 programme at a combination of full and partial loads. Actual water consumption will depend on how the appliance is used and on the hardness of the water.	48	
Maximum temperature inside the treated textile ^(b) (⁽³⁾ C)	Rated capacity	33	Weighted remaining moisture content ^(b) (%)	53.9	
	Half	28			
	Quarter	24			
Spin speed ^(b) (rpm)	Rated capacity	1350	Spin-drying efficiency class ^(b)	B (⁽⁴⁾)	
	Half	1350			
	Quarter	1350			
Programme duration ^(b) (h:min)	Rated capacity	3:38	Type	free-standing	
	Half	2:48			
	Quarter	2:48			
Airborne acoustical noise emissions in the spinning phase ^(b) (dB(A) re 1 pW)	72		Airborne acoustical noise emission class ^(b) (spinning phase)	A (⁽⁴⁾)	
Off-mode (W) (if applicable)	0.50		Standby mode (W)(if applicable)	N/A	
Delay start (W) (if applicable)	4.00		Networked standby (W)(if applicable)	N/A	

Minimum duration of the guarantee offered by the supplier ^(*)(⁽¹⁾):

This product has been designed to release silver ions during the washing cycle

NO

Additional information:

Weblink to the supplier's website, where the information in point 9 of Annex II to Commission Regulation (EU)2019/2023⁽¹⁾ is found:

⁽¹⁾ this item shall not be considered relevant for the purposes of Article 2(6) of Regulation (EU) 2017/1369, ⁽²⁾ for the eco 40-60 programme.

⁽³⁾ changes to this item shall not be considered relevant for the purposes of paragraph 4 of Article 4 of Regulation (EU)2017/1369.

⁽⁴⁾ if the product database automatically generates the definitive content of this cell, the supplier shall not enter these data.

Supplier's name or trade mark ^(*) (⁽¹⁾):					
Supplier's address ^(*) (⁽¹⁾):					
Model identifier ^(*) : ÄÜFI JT ÖFI QX					
General product parameters:					
Parameter	Value		Parameter	Value	
Rated capacity ^(b) (kg)	9.0		Dimensions in cm ^(b) (⁽²⁾)	Height	85
				Width	60
				Depth	53
Energy efficiency index ^(b) (EEI _w)	51.9		Energy efficiency class ^(b)	A (^(d))	
Washing efficiency index ^(b)	1.031		Rinsing effectiveness (g/kg) ^(b)	5.0	
Energy consumption in kWh per cycle, based on the eco 40-60 programme at a combination of full and partial loads. Actual energy consumption will depend on how the appliance is used.	0.494		Water consumption in litre per cycle, based on the eco 40-60 programme at a combination of full and partial loads. Actual water consumption will depend on how the appliance is used and on the hardness of the water.	50	
Maximum temperature inside the treated textile ^(b) (⁽³⁾)	Rated capacity	36	Weighted remaining moisture content ^(b) (%)	53.9	
	Half	32			
	Quarter	25			
Spin speed ^(b) (rpm)	Rated capacity	1350	Spin-drying efficiency class ^(b)	B (^(d))	
	Half	1350			
	Quarter	1350			
Programme duration ^(b) (h:min)	Rated capacity	3:48	Type	free-standing	
	Half	2:54			
	Quarter	2:54			
Airborne acoustical noise emissions in the spinning phase ^(b) (dB(A) re 1 pW)	72		Airborne acoustical noise emission class ^(b) (spinning phase)	A (^(d))	
Off-mode (W) (if applicable)	0.50		Standby mode (W)(if applicable)	N/A	
Delay start (W) (if applicable)	4.00		Networked standby (W)(if applicable)	N/A	
Minimum duration of the guarantee offered by the supplier ^(*) (⁽⁴⁾):					
This product has been designed to release silver ions during the washing cycle			NO		
Additional information:					
Weblink to the supplier's website, where the information in point 9 of Annex II to Commission Regulation (EU)2019/2023 ⁽¹⁾ is found:					
⁽¹⁾ this item shall not be considered relevant for the purposes of Article 2(6) of Regulation (EU) 2017/1369, ⁽²⁾ for the eco 40-60 programme, ⁽³⁾ changes to this item shall not be considered relevant for the purposes of paragraph 4 of Article 4 of Regulation (EU)2017/1369. ⁽⁴⁾ if the product database automatically generates the definitive content of this cell, the supplier shall not enter these data.					

Supplier's name or trade mark^(*)(⁽¹⁾):
 Supplier's address^(*)(⁽¹⁾):
 Model identifier^(*): AJÜFI FET ÖFI QX

General product parameters:				
Parameter	Value	Parameter	Value	
Rated capacity ^(b) (kg)	10.0	Dimensions in cm ^(*) (⁽²⁾)	Height	85
			Width	60
			Depth	53
Energy efficiency index ^(b) (EEI _w)	51.9	Energy efficiency class ^(b)	A (⁽⁴⁾)	
Washing efficiency index ^(b)	1.031	Rinsing effectiveness (g/kg) ^(b)	5.0	
Energy consumption in kWh per cycle, based on the eco 40-60 programme at a combination of full and partial loads. Actual energy consumption will depend on how the appliance is used.	0.513	Water consumption in litre per cycle, based on the eco 40-60 programme at a combination of full and partial loads. Actual water consumption will depend on how the appliance is used and on the hardness of the water.	52	
Maximum temperature inside the treated textile ^(b) (⁽³⁾)	Rated capacity	37	Weighted remaining moisture content ^(b) (%)	53.9
	Half	33		
	Quarter	23		
Spin speed ^(b) (rpm)	Rated capacity	1350	Spin-drying efficiency class ^(b)	B (⁽⁴⁾)
	Half	1350		
	Quarter	1350		
Programme duration ^(b) (h:min)	Rated capacity	3:59	Type	free-standing
	Half	3:00		
	Quarter	3:00		
Airborne acoustical noise emissions in the spinning phase ^(b) (dB(A) re 1 pW)	72	Airborne acoustical noise emission class ^(b) (spinning phase)	A (⁽⁴⁾)	
Off-mode (W) (if applicable)	0.50	Standby mode (W)(if applicable)	N/A	
Delay start (W) (if applicable)	4.00	Networked standby (W)(if applicable)	N/A	

Minimum duration of the guarantee offered by the supplier ^(*)(⁽¹⁾):
 This product has been designed to release silver ions during the washing cycle

NO

Additional information:
 Weblink to the supplier's website, where the information in point 9 of Annex II to Commission Regulation (EU)2019/2023⁽¹⁾ is found:

⁽¹⁾ this item shall not be considered relevant for the purposes of Article 2(6) of Regulation (EU) 2017/1369,
⁽²⁾ for the eco 40-60 programme.
⁽³⁾ changes to this item shall not be considered relevant for the purposes of paragraph 4 of Article 4 of Regulation (EU)2017/1369.
⁽⁴⁾ if the product database automatically generates the definitive content of this cell, the supplier shall not enter these data.

Supplier's name or trade mark^(*)(^(†)):

Supplier's address^(*)(^(†)):

Model identifier^(*): ÁÚFG T ÓFÍ Q X

General product parameters:

Parameter	Value	Parameter	Value	
Rated capacity ^(b) (kg)	7.0	Dimensions in cm ^(b) (^(‡))	Height	85
			Width	60
			Depth	40
Energy efficiency index ^(b) (EEI _n)	51.5	Energy efficiency class ^(b)	A (^(‡))	
Washing efficiency index ^(b)	1.031	Rinsing effectiveness (g/kg) ^(b)	5.0	
Energy consumption in kWh per cycle, based on the eco 40-60 programme at a combination of full and partial loads. Actual energy consumption will depend on how the appliance is used.	0.444	Water consumption in litre per cycle, based on the eco 40-60 programme at a combination of full and partial loads. Actual water consumption will depend on how the appliance is used and on the hardness of the water.	45	
Maximum temperature inside the treated textile ^(b) (C)	Rated capacity	37	Weighted remaining moisture content ^(b) (%)	62.9
	Half	33		
	Quarter	23		
Spin speed ^(b) (rpm)	Rated capacity	1200	Spin-drying efficiency class ^(b)	C (^(‡))
	Half	1200		
	Quarter	1200		
Programme duration ^(b) (h:min)	Rated capacity	3:28	Type	free-standing
	Half	2:42		
	Quarter	2:42		
Airborne acoustical noise emissions in the spinning phase ^(b) (dB(A) re 1 pW)	72	Airborne acoustical noise emission class ^(b) (spinning phase)	A (^(‡))	
Off-mode (W) (if applicable)	0.50	Standby mode (W)(if applicable)	1.00	
Delay start (W) (if applicable)	4.00	Networked standby (W)(if applicable)	N/A	

Minimum duration of the guarantee offered by the supplier^(*)(^(†)):

This product has been designed to release silver ions during the washing cycle

NO

Additional information:

Weblink to the supplier's website, where the information in point 9 of Annex II to Commission Regulation (EU)2019/2023^(†) is found:

(^(*)) this item shall not be considered relevant for the purposes of Article 2(6) of Regulation (EU) 2017/1369,

(^(†)) for the eco 40-60 programme.

(^(‡)) changes to this item shall not be considered relevant for the purposes of paragraph 4 of Article 4 of Regulation (EU)2017/1369.

(^(§)) if the product database automatically generates the definitive content of this cell, the supplier shall not enter these data.

CLEANING AND MAINTENANCE

Cleaning and Care

WARNING

- Always unplug the appliance and close the water tap before cleaning and maintenance.

Cleaning the Cabinet

Proper maintenance on the machine can extend its working life. The surface can be cleaned with diluted non-abrasive neutral detergents when necessary. If there is any water overflow, use a towel to wipe it off immediately. Never use sharp items to clean the appliance.

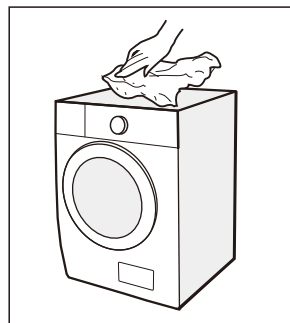

CAUTION

- Never use abrasive or caustic agents. Such as formic acids or its diluted solvents or similar substances, like alcohol or chemical products.

Cleaning the Drum

Any rust stains left inside the drum by metal articles must be removed immediately using chlorine-free detergents. Never use steel wool for cleaning the drum!

NOTE

- Keep any laundry away from the machine while cleaning the drum.

Cleaning the Door Seal and Glass

Wipe the glass and seal after each wash to remove lint and stains. If lint builds up it can cause leakages. Remove any coins, buttons and other objects from the seal after each wash. Clean the door seal and glass every month to ensure the normal operation of the appliance.

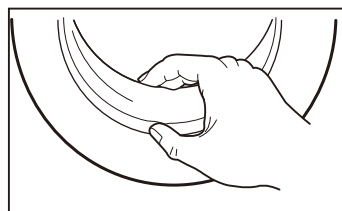

Cleaning the Inlet Filter

NOTE

- Diminishing water flow is a sign that the filter needs to be cleaned.

1. Close the tap and remove the water supply hose from it.

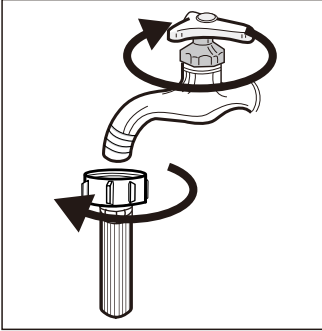

2. Clean the filter with a brush.

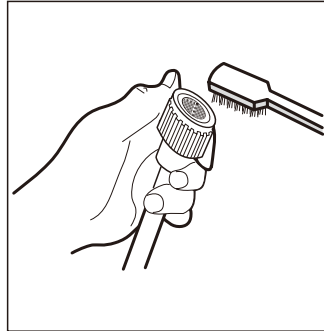

3. Unscrew the water supply hose from the backside of the machine. Pull out the filter with long nose pliers.

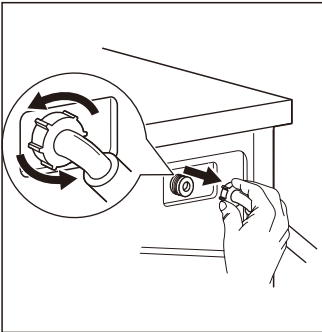

4. Use a brush to clean the filter.

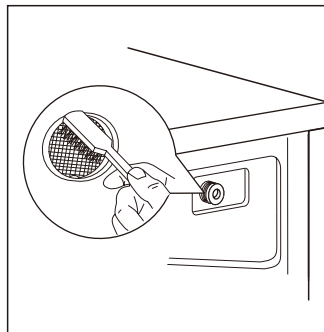

5. Reinstall the filter to the water inlet and reconnect the water supply hose.

6. Clean the Inlet filter every 3 months to ensure the normal operation of the appliance.

CLEANING AND MAINTENANCE

Cleaning the Detergent Dispenser

1. Press down the release [] on the softener cover and pull the dispenser drawer out of the recess. Clean the inside of the recess with a brush.
2. Lift the softener cover off the dispenser drawer and wash both items with water.
3. Restore the softener cover and push the drawer back into the recess.

1. Press the release and remove the dispenser drawer

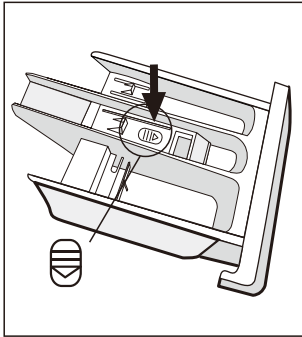

2. Clean the dispenser drawer and the softener cover under water

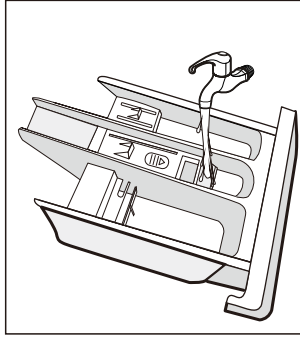

3. Clean the recess with a soft brush

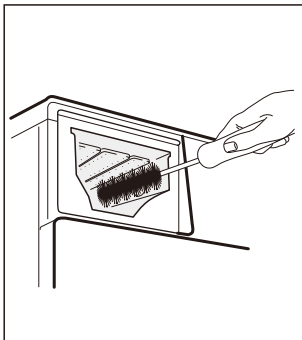

4. Insert the dispenser drawer

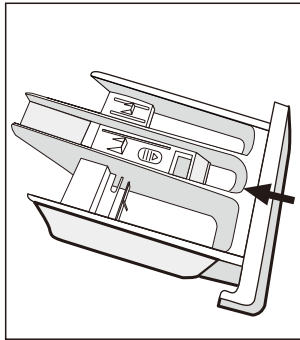

NOTE

- Do not use abrasive or caustic agents to clean plastic parts.
- Clean the detergent dispenser every 3 months to ensure the normal operation of the appliance.

Cleaning the Drain Pump Filter

WARNING

- Make sure that the machine has finished the washing cycle and is empty. Switch it off and unplug it before cleaning the drain pump filter.
- Be careful of hot water. Wait for water cooling down. Risk of scalding!
- Clean the filter periodically every 3 months to ensure the normal operation of the appliance.

1. Open the lower cover cap

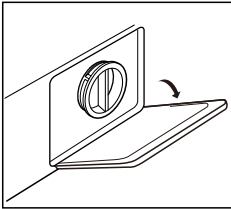

2. Open the filter by turning to the counter clockwise

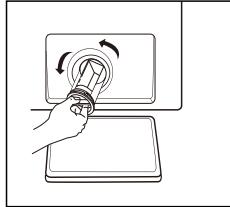

3. Remove extraneous matter

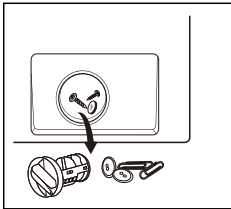

4. Close the lower cover cap

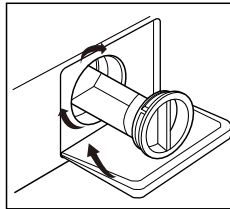

CAUTION

- When the appliance is in use and depending on the programme selected there can be hot water in the pump. Never remove the pump cover during a wash cycle, always wait until the appliance has finished the cycle, and is empty. When replacing the cover, ensure it is securely re-tightened.

TROUBLE SHOOTING

Whenever there is a problem with the appliance, check if you can solve it following the tables below. If the problem persists, please contact the customer service.

Description	Possible Cause	Solution
Appliance does not start	Door is not closed properly. Clothes are stuck.	Close the door properly and restart. Check the laundry.
Door can't be opened	Safety protection is activated.	Disconnect the power and restart.
Water leakage	Connections are not tight enough.	Check and fasten the water inlet pipe. Check and clean the outlet hose.
Detergent residues in the detergent dispenser	Detergent is damp and/or clotted.	Clean and wipe the detergent dispenser dry.
Indicator or display does not work	PC board or harness have connection problems.	Switch off the power and check if the mains plug is connected properly.
Abnormal noise	Fixing bolts are still in place. Floor is not solid or level.	Check if the fixing bolts have been removed. Make sure the appliance is installed on a solid and level floor.

Error Codes

Description	Possible Cause	Solution
E30	Door is not closed properly.	Close the door properly and restart.
E10	Water injecting problem during wash cycle.	Check if the water pressure is high enough. Straighten the water pipe. Clean the inlet valve filter.
E21	Overtime water draining	Check the drain hose for blockage.
E12	Water overflow	Restart the appliance.
EXX	Others	Restart the appliance. If problem persists, please contact the customer service.

DISPOSAL AND RECYCLING

Important Instructions for Environment

Compliance with the WEEE Directive and Disposing of the Waster Product:
This product complies with EU WEEE Directive (2012/19/EU). This product bears a classification symbol for waster electrical and electronic equipment (WEEE).

This symbol indicates that this product shall not be disposed with other household wastes at the end of its service life. Used device must be returned to official collection point for recycling of electrical electronic devices. To find these collection systems please contact to your local authorities or retailer where the product was purchased. Each household performs important role in recovering and recycling of old appliance. Appropriate disposal of used appliance helps prevent potential negative consequences for the environment and human health.

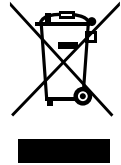

Compliance with RoHS Directive

The product you have purchased complies with EU RoHS Directive (2011/65/EU). It does not contain harmful and prohibited materials specified in the Directive.

Package Information

Packaging materials of the product are manufactured from recyclable materials in accordance with our National Environment Regulations. Do not dispose of the packaging materials together with the domestic or other wastes. Take them to the packaging material collection points designated by the local authorities.



Customer Service

Spare parts for your appliance are available for a minimum of 10 years following EU COMMISSION REGULATION 2019/2023 ANNEX II Ecodesign requirements.

In case of questions, please contact our local customer service center.

WARNING

Risk of electric shock

- Never try to repair an appliance which is defective or presumed to be defective. You may put your own and future users' lives in danger. Only authorised specialists are allowed to carry out this repair work.
- Improper repair will void the warranty and subsequent damages can't be recognized!

Transport

IMPORTANT STEPS WHEN MOVING THE APPLIANCE

- Unplug the appliance and close the water inlet tap.
- Check if the door and the detergent dispenser are closed properly.
- Remove the water inlet pipe and the outlet hose from the house installations.
- Let the water drain completely from the appliance (see "Cleaning the Drain Pump Filter")
- Important: Re-install the 4 transport bolts in the back of the appliance.
- This appliance is heavy. Transport with care. Never hold any protruding part of the machine when lifting. The machine door can not be used as a handle.

Ovaj dokument je originalno proizveden i objavljen od strane proizvođača, brenda Končar, i preuzet je sa njihove zvanične stranice. S obzirom na ovu činjenicu, Tehnoteka ističe da ne preuzima odgovornost za tačnost, celovitost ili pouzdanost informacija, podataka, mišljenja, saveta ili izjava sadržanih u ovom dokumentu.

Napominjemo da Tehnoteka nema ovlašćenje da izvrši bilo kakve izmene ili dopune na ovom dokumentu, stoga nismo odgovorni za eventualne greške, propuste ili netačnosti koje se mogu naći unutar njega. Tehnoteka ne odgovara za štetu nanесenu korisnicima pri upotrebi netačnih podataka. Ukoliko imate dodatna pitanja o proizvodu, ljubazno vas molimo da kontaktirate direktno proizvođača kako biste dobili sve detaljne informacije.

Za najnovije informacije o ceni, dostupnim akcijama i tehničkim karakteristikama proizvoda koji se pominje u ovom dokumentu, molimo posetite našu stranicu klikom na sledeći link:

<https://tehnoteka.rs/p/koncar-masina-za-pranje-vesa-pr149mg17inv-akcija-cena/>