

Uputstvo za upotrebu (EN)

MSI zakrivljeni monitor 34" VA Modern MD342CQP



Tehnoteka je online destinacija za upoređivanje cena i karakteristika bele tehnike, potrošačke elektronike i IT uređaja kod trgovinskih lanaca i internet prodavnica u Srbiji. Naša stranica vam omogućava da istražite najnovije informacije, detaljne karakteristike i konkurentne cene proizvoda.

Posetite nas i uživajte u ekskluzivnom iskustvu pametne kupovine klikom na link:

<https://tehnoteka.rs/p/msi-zakrivljeni-monitor-34-va-modern-md342cqp-akcija-cena/>



Modern Series

LCD Monitor

Modern MD342CQP (3PC5)

Modern MD342CQPW (3PC5)

User Guide

Contents

Getting Started.....	3
Package Contents.....	3
Installing the Monitor Stand.....	4
Adjusting the Monitor.....	5
Monitor Overview.....	6
Connecting the Monitor to PC.....	9
OSD Setup.....	10
OSD Keys.....	10
OSD Menus.....	11
Modern MD342CQP.....	11
Modern MD342CQPW.....	11
Professional.....	12
Image.....	14
Input Source.....	14
PIP/PBP.....	15
Navi Key.....	16
Settings.....	16
Specifications.....	18
Preset Display Modes.....	20
Troubleshooting.....	22
Safety Instructions.....	23
TÜV Rheinland Certification.....	25
ENERGY STAR Certification.....	25
Regulatory Notices.....	26

Revision

V1.1, 2024/11

Getting Started

This chapter provides you with the information on hardware setup procedures. While connecting devices, be careful in holding the devices and use a grounded wrist strap to avoid static electricity.

Package Contents

Monitor	Modern MD342CQP
	Modern MD342CQPW
Documentation	Quick Start Guide
Accessories	Stand
	Stand Base with Screw(s)
	Screw(s) for Wall Mount Bracket(s)
	Power Cord
	External Power Supply
Cables	DisplayPort Cable
	USB Upstream Cable (for USB Type-B Upstream Port)



Important

- *Contact your place of purchase or local distributor if any of the items is damaged or missing.*
- *Package contents may vary by country and model.*
- *The included power cord is exclusively for this monitor and should not be used with other products.*

Installing the Monitor Stand

1. Leave the monitor in its protective packaging. Align and gently push the stand bracket towards the monitor groove until it locks in place.
2. Connect the base to the stand and tighten the screw to secure the base.
3. Make sure the stand assembly is properly installed before setting the monitor upright.

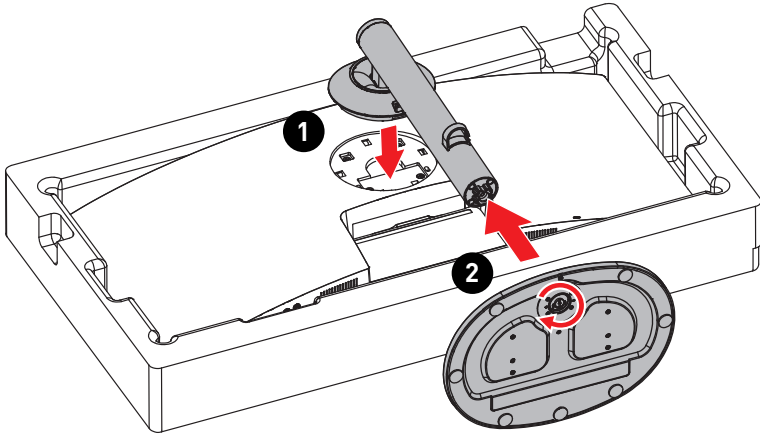

Important

- Place the monitor on a soft, protected surface to avoid scratching the display panel.
- Do not use any sharp objects on the panel.
- The groove for installing the stand bracket can also be used for wall mount. Please contact your dealer for proper wall mount kit.
- This product comes with NO protective film to be removed by the user! Any mechanical damages to the product including removal of the polarizing film may affect the warranty!

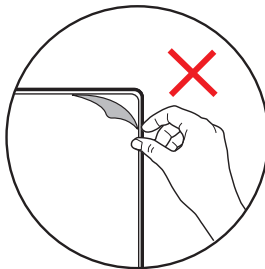

Adjusting the Monitor

This monitor is designed to maximize your viewing comfort with its adjustment capabilities.



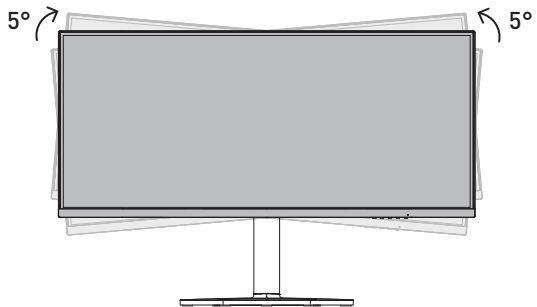
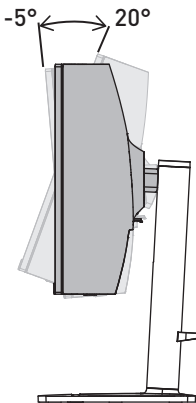
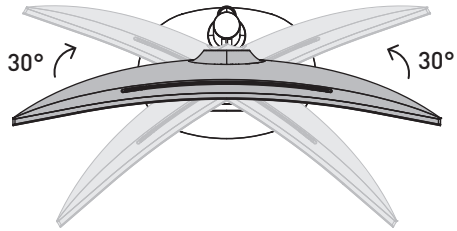
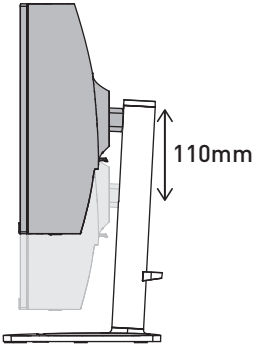

 **Important**

- Avoid touching the display panel when adjusting the monitor.
- The reserved pivot 5° is designed for adjusting the level imbalance of some tables.

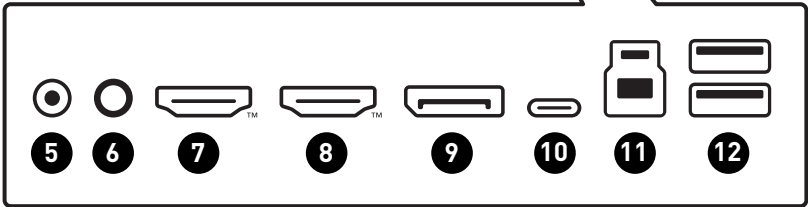
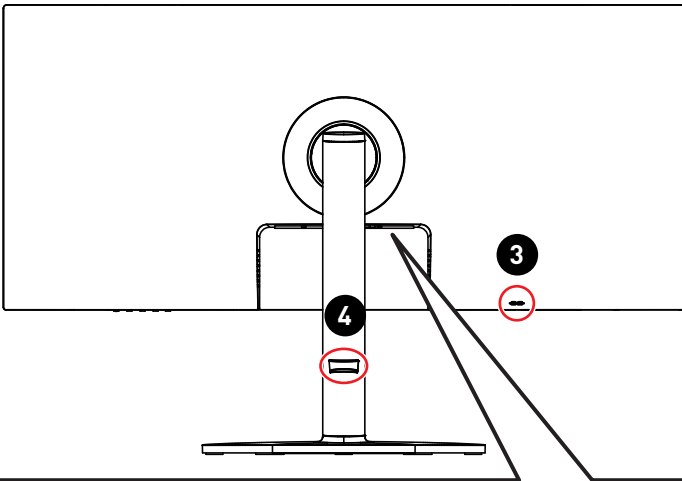
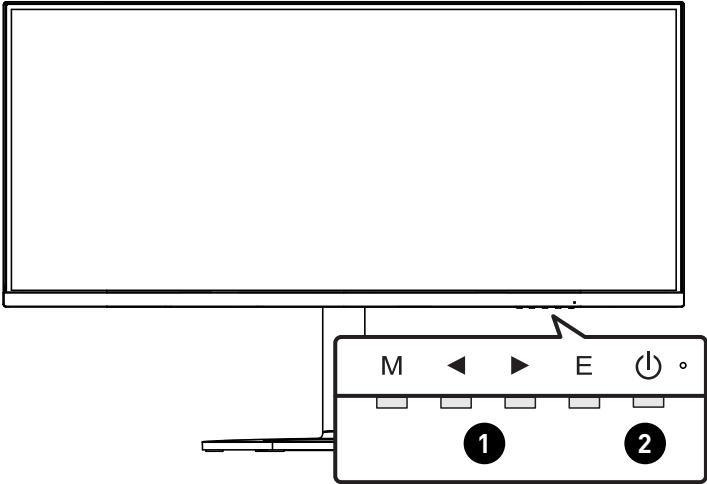

Monitor Overview

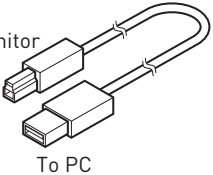

1	OSD Keys						
2	Power Button & Power LED Lit in white after the monitor is turned on. If no signal input, the LED will turn into orange. Lit in orange when the monitor is in Stand-by mode.						
3	Kensington Lock						
4	Cable Routing Hole						
5	Power Jack						
6	Headphone Jack						
7	HDMI™ Connector  <small>HIGH-DEFINITION MULTIMEDIA INTERFACE</small> Supports HDMI™ CEC, 3440x1440@100Hz as specified in HDMI™ 2.0b.  Important <i>To ensure optimal performance and compatibility, please use only HDMI™ cables certified with the official HDMI™ logo when connecting this monitor. For more information, please visit https://www.hdmi.org/resource/cables.</i>						
8	HDMI™ Connector  <small>HIGH-DEFINITION MULTIMEDIA INTERFACE</small> Supports 3440x1440@100Hz as specified in HDMI™ 2.0b.  Important <i>To ensure optimal performance and compatibility, please use only HDMI™ cables certified with the official HDMI™ logo when connecting this monitor. For more information, please visit https://www.hdmi.org/resource/cables.</i>						
9	DisplayPort Supports 3440x1440@120Hz as specified in DisplayPort 1.4a.						
10	USB Type-C Port This port supports DisplayPort Alternate (DP Alt) Mode and up to 20V/4.9A (98W) power delivery.  Important <i>Your USB-C signal source and cable must support DisplayPort Alternate Mode to enable video output to the monitor.</i> <table border="1" data-bbox="734 1114 931 1332"> <thead> <tr> <th data-bbox="734 1114 931 1165">USB Type-C Power Delivery</th> </tr> </thead> <tbody> <tr> <td data-bbox="734 1165 931 1197">5V / 3A (15W)</td> </tr> <tr> <td data-bbox="734 1197 931 1228">9V / 3A (27W)</td> </tr> <tr> <td data-bbox="734 1228 931 1260">12V / 3A (36W)</td> </tr> <tr> <td data-bbox="734 1260 931 1292">15V / 3A (45W)</td> </tr> <tr> <td data-bbox="734 1292 931 1332">20V / 4.9A (98W)</td> </tr> </tbody> </table>	USB Type-C Power Delivery	5V / 3A (15W)	9V / 3A (27W)	12V / 3A (36W)	15V / 3A (45W)	20V / 4.9A (98W)
USB Type-C Power Delivery							
5V / 3A (15W)							
9V / 3A (27W)							
12V / 3A (36W)							
15V / 3A (45W)							
20V / 4.9A (98W)							

11	<p>USB 5Gbps Type-B Upstream Port</p> <p>For USB Upstream Cable.</p> <p> Important</p> <p><i>Check the package for USB Upstream Cable and connect it to the PC and monitor. Once this cable is connected, the USB Type-A Downstream Ports on the monitor will be ready for use.</i></p> <p>To Monitor</p>  <p>To PC</p>
12	<p>USB 5Gbps Port</p> <p>This connector is provided for USB peripheral devices. (Speed up to 5 Gbps)</p>

Connecting the Monitor to PC

1. Turn off your computer.
2. Connect the video cable from the monitor to your computer.
3. Assemble the external power supply & power cord. (Figure A)
4. Connect the external power supply to the monitor power jack. (Figure B)
5. Plug the power cord into the electrical outlet. (Figure C)
6. Turn on the monitor. (Figure D)
7. Power on the computer and the monitor will auto detect the signal source.

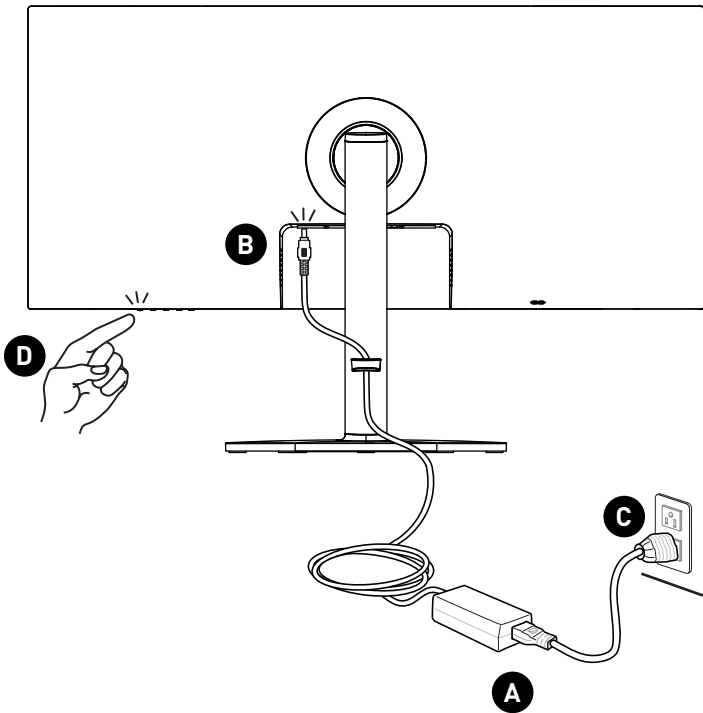

OSD Setup

This chapter provides you with essential information on OSD Setup.



Important

All information is subject to change without prior notice.

OSD Keys

The monitor comes with a set of OSD Keys that help to control the On-Screen Display (OSD) menu.

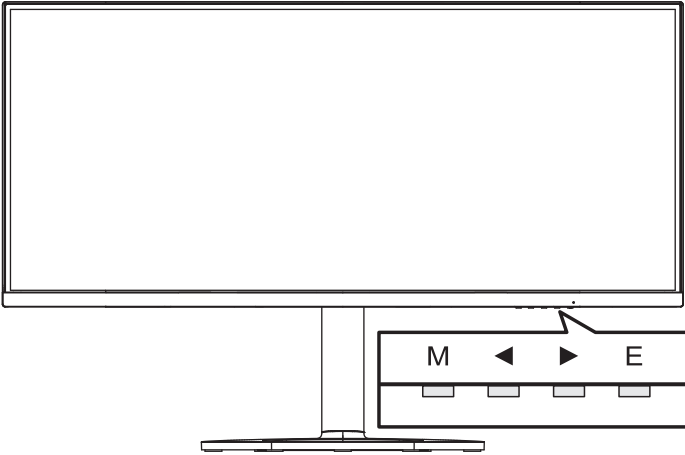

OSD Key	Hot Key (When OSD is OFF)	OSD Setup (When OSD is ON)
M	<ul style="list-style-type: none">Activating the OSD Main Menu	<ul style="list-style-type: none">Entering the submenus.Confirming a selection or setting.
◀	<ul style="list-style-type: none">Mode	<ul style="list-style-type: none">Navigating through function menus and items.Adjusting function values.
▶	<ul style="list-style-type: none">Input Source	
E	<ul style="list-style-type: none">Audio Volume	<ul style="list-style-type: none">Confirming the selection.Exiting the current menu.

OSD Menus

Modern MD342CQP

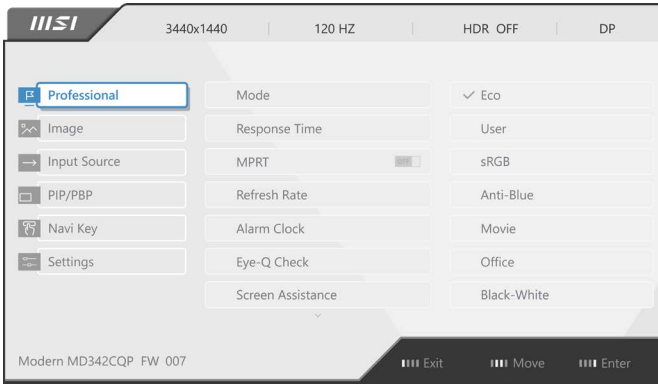

Modern MD342CQPW

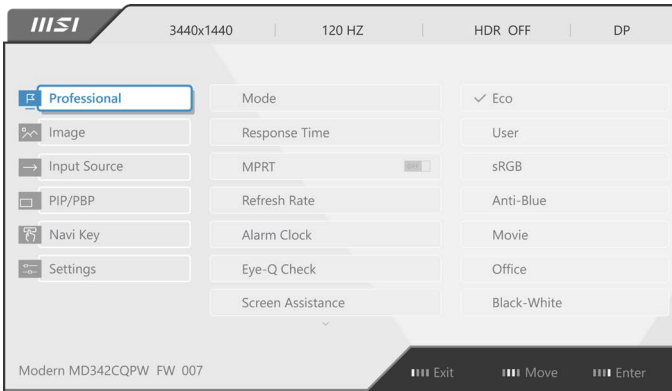

Important

The following settings will be grayed out when HDR signals are received:

- MPRT
- Low Blue Light
- HDCR
- Brightness
- Contrast
- Color Temperature
- sRGB

Professional

1st Level Menu	2nd/3rd Level Menu		Description											
Mode	Eco		<ul style="list-style-type: none"> Use Up or Down Button to select and preview mode effects. Press the E Button to confirm and apply your mode type. Activating sRGB will affect: <table border="1" data-bbox="551 347 931 464"> <thead> <tr> <th>Affected Function</th> <th>Function Status</th> </tr> </thead> <tbody> <tr> <td>» Color Temperature</td> <td rowspan="3">Unable to select</td> </tr> <tr> <td>» Contrast</td> </tr> <tr> <td>» Low Blue Light</td> </tr> </tbody> </table> 	Affected Function	Function Status	» Color Temperature	Unable to select	» Contrast	» Low Blue Light					
	Affected Function	Function Status												
	» Color Temperature	Unable to select												
	» Contrast													
	» Low Blue Light													
	User													
	sRGB													
Anti-Blue														
Movie														
Office														
Black-White														
Response Time	Normal		<ul style="list-style-type: none"> Setting to Fastest will reach the shortest response time and help improve blurred images when playing very fast games. 											
	Fast													
	Fastest													
MPRT	OFF		<ul style="list-style-type: none"> MPRT is available when the refresh rate is over 85 Hz. Activating MPRT will affect: <table border="1" data-bbox="551 667 931 874"> <thead> <tr> <th>Affected Function</th> <th>Function Status</th> </tr> </thead> <tbody> <tr> <td>» Response Time</td> <td rowspan="2">Unable to select</td> </tr> <tr> <td>» Brightness</td> </tr> <tr> <td>» Adaptive-Sync</td> <td rowspan="2">Set to OFF</td> </tr> <tr> <td>» HDCR</td> </tr> <tr> <td>» PIP/PBP</td> <td rowspan="2">Set to Auto</td> </tr> <tr> <td>» Screen Size</td> </tr> </tbody> </table> 	Affected Function	Function Status	» Response Time	Unable to select	» Brightness	» Adaptive-Sync	Set to OFF	» HDCR	» PIP/PBP	Set to Auto	» Screen Size
	Affected Function	Function Status												
	» Response Time	Unable to select												
	» Brightness													
	» Adaptive-Sync	Set to OFF												
	» HDCR													
» PIP/PBP	Set to Auto													
» Screen Size														
ON														
Refresh Rate	Location	Left Top	<ul style="list-style-type: none"> Location is adjustable in OSD Menu. Press the E Button to confirm and apply your Refresh Rate Location. This monitor follows and works at the Operating System's preset Screen Refresh Rate. 											
		Right Top												
		Left Bottom												
		Right Bottom												
	OFF													
	ON													
Alarm Clock	Location	Left Top	<ul style="list-style-type: none"> After setting the time, press the E Button to activate the timer. Users have to manually restore their preset Alarm Clock after any AC power loss and reconnection. 											
		Right Top												
		Left Bottom												
		Right Bottom												
	OFF													
	15:00	00:01 ~ 99:59												
	30:00													
	45:00													
	60:00													

1st Level Menu	2nd/3rd Level Menu	Description						
Eye-Q Check	OFF	<ul style="list-style-type: none"> Select OFF to disable Eye-Q Check. 						
	Amsler Grid	<ul style="list-style-type: none"> Select Amsler Grid to check your central vision field. 						
	Astigmatism	<ul style="list-style-type: none"> Select Astigmatism to check your blurred vision. 						
	Posture Correction	<ul style="list-style-type: none"> Select Posture Correction to improve your posture when sitting. 						
Screen Assistance	None	<ul style="list-style-type: none"> Users can adjust Screen Assistance in any mode. 						
								
KVM	Auto	<ul style="list-style-type: none"> Auto allows the monitor to automatically switch between USB input sources, such as keyboards, mice or other USB devices. Users can also designate Upstream port or USB Type-C as the only USB signal source. 						
	Upstream							
	Type C							
Screen Size	Auto	<ul style="list-style-type: none"> Users can adjust Screen Size in any mode, any resolution and any screen refresh rate. Activating Screen Size 1:1 will affect: <table border="1" data-bbox="551 935 932 1050"> <thead> <tr> <th>Affected Function</th> <th>Function Status</th> </tr> </thead> <tbody> <tr> <td>» MPRT</td> <td rowspan="3">Set to OFF</td> </tr> <tr> <td>» Adaptive-Sync</td> </tr> <tr> <td>» PIP/PBP</td> </tr> </tbody> </table> 	Affected Function	Function Status	» MPRT	Set to OFF	» Adaptive-Sync	» PIP/PBP
	Affected Function		Function Status					
	» MPRT		Set to OFF					
	» Adaptive-Sync							
	» PIP/PBP							
4:3								
16:9								
21:9								
1:1								
Adaptive-Sync	OFF	<ul style="list-style-type: none"> Adaptive-Sync prevents screen tearing. When Adaptive-Sync is set to ON, it is mandatory to enable HDMI™ VRR. Activating Adaptive-Sync will affect: <table border="1" data-bbox="551 1185 932 1300"> <thead> <tr> <th>Affected Function</th> <th>Function Status</th> </tr> </thead> <tbody> <tr> <td>» MPRT</td> <td rowspan="3">Set to OFF</td> </tr> <tr> <td>» PIP/PBP</td> </tr> <tr> <td>» Screen Size 1:1</td> </tr> </tbody> </table> 	Affected Function	Function Status	» MPRT	Set to OFF	» PIP/PBP	» Screen Size 1:1
	Affected Function		Function Status					
» MPRT	Set to OFF							
» PIP/PBP								
» Screen Size 1:1								
ON								

Image

1st Level Menu	2nd/3rd Level Menu	Description						
Brightness	0-100	<ul style="list-style-type: none"> Properly adjust Brightness according to the surrounding lighting. 						
Contrast	0-100	<ul style="list-style-type: none"> Properly adjust Contrast to relax your eyes. 						
Sharpness	0-5	<ul style="list-style-type: none"> Sharpness improves clarity and details of images. 						
Image Enhancement	OFF	<ul style="list-style-type: none"> Image Enhancement enhances image edges to improve their acutance. 						
	Weak							
	Medium							
	Strong							
	Strongest							
Low Blue Light	OFF	<ul style="list-style-type: none"> Low Blue Light protects your eyes against blue light. When enabled, Low Blue Light adjusts the screen color temperature to a more yellow glow. 						
	ON							
HDCR	OFF	<ul style="list-style-type: none"> HDCR enhances image quality by increasing the contrast of images. Activating HDCR will affect: <table border="1" data-bbox="583 730 934 815"> <thead> <tr> <th>Affected Function</th> <th>Function Status</th> </tr> </thead> <tbody> <tr> <td>» Brightness</td> <td>Unable to select</td> </tr> <tr> <td>» MPRT</td> <td>Set to OFF</td> </tr> </tbody> </table> 	Affected Function	Function Status	» Brightness	Unable to select	» MPRT	Set to OFF
	Affected Function		Function Status					
» Brightness	Unable to select							
» MPRT	Set to OFF							
	ON							
Color Temperature	Cool	<ul style="list-style-type: none"> Use Up or Down Button to select and preview mode effects. Press the E Button to confirm and apply your mode type. Users can adjust Color Temperature in Customization mode. 						
	Normal							
	Warm							
	Customization		R (0-100)					
			G (0-100)					
B (0-100)								

Input Source

1st Level Menu	2nd Level Menu	Description
HDMI™1		<ul style="list-style-type: none"> Users can adjust Input Source in any mode.
HDMI™2		
DP		
Type C		
Auto Scan	OFF	<ul style="list-style-type: none"> Users can use the Navi Key to select Input Source at below status: <ul style="list-style-type: none"> While "Auto Scan" is set to "OFF" with the monitor at power saving mode; While "No Signal" message box is shown on the monitor.
	ON	

PIP/PBP

1st Level Menu	2nd/3rd Level Menu		Description														
OFF			<ul style="list-style-type: none"> PIP (Picture in Picture) allows users to simultaneously display multiple video sources on one screen. One program is displayed on the full screen at the same time as one or more other programs are displayed in inset windows. PBP (Picture by Picture) is a similar feature that displays two input sources side-by-side on the screen. Display Switch allows users to switch between primary and secondary input sources. If there is only one signal input, the Display Switch and Audio Switch will be grayed out. Activating PIP/PBP will affect: <table border="1" data-bbox="551 544 932 770"> <thead> <tr> <th>Affected Function</th> <th>Function Status</th> </tr> </thead> <tbody> <tr> <td>» Response Time</td> <td>Unable to select</td> </tr> <tr> <td>» MPRT</td> <td></td> </tr> <tr> <td>» Adaptive-Sync</td> <td>Set to OFF</td> </tr> <tr> <td>» HDMI™ CEC</td> <td>Set to OFF & unable to select</td> </tr> <tr> <td>» PIP: Screen Size 1:1</td> <td></td> </tr> <tr> <td>» PBP: Screen Size</td> <td>Set to Auto & unable to select</td> </tr> </tbody> </table> 	Affected Function	Function Status	» Response Time	Unable to select	» MPRT		» Adaptive-Sync	Set to OFF	» HDMI™ CEC	Set to OFF & unable to select	» PIP: Screen Size 1:1		» PBP: Screen Size	Set to Auto & unable to select
Affected Function	Function Status																
» Response Time	Unable to select																
» MPRT																	
» Adaptive-Sync	Set to OFF																
» HDMI™ CEC	Set to OFF & unable to select																
» PIP: Screen Size 1:1																	
» PBP: Screen Size	Set to Auto & unable to select																
PIP	Source	HDMI™1															
		HDMI™2															
		DP															
		Type C															
	PIP Size	Small															
		Medium															
		Large															
	Location	Left Top															
		Right Top															
		Left Bottom															
Right Bottom																	
Display Switch																	
Audio Switch																	
PBP	Source 1	HDMI™1															
		HDMI™2															
		DP															
		Type C															
	Source 2	HDMI™1															
		HDMI™2															
		DP															
		Type C															
	Display Switch																
	Audio Switch																

Navi Key



1st Level Menu	2nd Level Menu	Description
Enter Left Right	OFF	<ul style="list-style-type: none"> All Navi Key items can be adjusted via OSD Menus.
	Brightness	
	Mode	
	Alarm Clock	
	Input Source	
	Refresh Rate	
	Info. On Screen	
	Audio Volume	
	KVM	

Settings

1st Level Menu	2nd/3rd Level Menu	Description
Language	繁體中文	<ul style="list-style-type: none"> Users have to press the E Button to confirm and apply the Language setting. Language is an independent setting. Users' own language setting will override the factory. When users set Reset to Yes, Language will not be changed.
	English	
	Français	
	Deutsch	
	Italiano	
	Español	
	한국어	
	日本語	
	Русский	
	Português	
	简体中文	
	Bahasa Indonesia	
	Türkçe	
(More languages coming soon)		
Transparency	0-5	<ul style="list-style-type: none"> Users can adjust Transparency in any mode.
OSD Time Out	5-30s	<ul style="list-style-type: none"> Users can adjust OSD Time Out in any mode.
Power Button	OFF	<ul style="list-style-type: none"> When set to OFF, users can press the power button to turn off the monitor.
	Standby	<ul style="list-style-type: none"> When set to Standby, users can press the power button to turn off the panel and backlight.

1st Level Menu	2nd/3rd Level Menu	Description
HDMI™ CEC	OFF	<ul style="list-style-type: none"> HDMI™ CEC (Consumer Electronics Control) supports Sony PlayStation®, Nintendo® Switch™, Xbox Series X S consoles and various audio-visual devices that are CEC-capable. If HDMI™ CEC is set to ON: <ul style="list-style-type: none"> The monitor will automatically power on when the CEC device is turned on. The CEC device will enter power saving mode when the monitor is turned off. When Sony PlayStation®, Nintendo® Switch™, or Xbox Series X S console is connected, Mode will be automatically set to default modes and can be adjusted to users' preferred modes later.
	ON	
Type C PD Charge	OFF	<ul style="list-style-type: none"> Type C PD Charge enables users to charge their devices through a USB Type-C connector, which can deliver up to 98W (20V/4.9A).
	ON	
USB C Hub Signal	2.0	<ul style="list-style-type: none"> When the "Type C" input source is selected, users can switch the USB signal between 2.0 (480 Mbps) and 3.0 (5 Gbps).
	3.0	
Info. On Screen	OFF	<ul style="list-style-type: none"> The information of the monitor status will be shown on the right side of the screen.
	ON	
Audio Volume	0-100	<ul style="list-style-type: none"> Users can adjust Audio Volume in any mode.
Reset	YES	<ul style="list-style-type: none"> Users can Reset and restore settings to original OSD Default in any mode.
	NO	

Specifications

Monitor	Modern MD342CQP Modern MD342CQPW
Size	34 inch
Curvature	Curve 1500R
Panel Type	VA
Resolution	3440x1440 (UWQHD)
Aspect Ratio	21:9
Brightness	300 nits (typ.)
Contrast Ratio	3500:1
Refresh Rate	120Hz
Response Time	1ms (MPRT)
I/O	<ul style="list-style-type: none"> • Headphone Jack x1 • HDMI™ Connector x2 • DisplayPort x1 • USB Type-C Port x1 • USB 5Gbps Type-B Upstream Port x1 • USB 5Gbps Type-A Port x2
View Angles	178°(H) , 178°(V)
DCI-P3*/ sRGB	95% / 119%
Surface Treatment	Anti-glare
Display Colors	1.07B (8bits + FRC)
Speaker	3W x2
Monitor Power Options	19V  9.47A
External Power Supply**	Model: ADS-210NL-19-3 190180E
Power Input	100~240Vac, 50~60Hz, Max 3.0A
Power Output	19V  9.5A
Adjustment (Height)	0 ~ 110mm
Adjustment (Tilt)	-5° ~ 20°
Adjustment (Swivel)	-30° ~ 30°
Adjustment (Pivot)	-5° ~ 5°
Kensington Lock	Yes

Monitor		Modern MD342CQP Modern MD342CQPW
VESA Mounting		<ul style="list-style-type: none"> • Plate Type: 75 x 75 mm • Screw Type: M4 x 10 mm <ul style="list-style-type: none"> • Thread Diameter: 4 mm • Thread Pitch: 0.7 mm • Thread Length: 10 mm
Dimension (W x H x D)		808.6 x 424.1 x 250.6 mm
Weight	Net	8.05 kg
	Gross	11.9 kg
Environment	Operating	<ul style="list-style-type: none"> • Temperature: 0°C to 40°C • Humidity: 20% to 90%, non-condensing • Altitude: 0 ~ 5000m
	Storage	<ul style="list-style-type: none"> • Temperature: -20°C to 60°C • Humidity: 10% to 90%, non-condensing

* Based on CIE1976 test standards.

** External Power Supply may vary by country.

Preset Display Modes



Important

All information is subject to change without prior notice.

Standard	Resolution		Standard Default Mode		
			HDMI™	DP	USB-C
QHD	2560x1440	@60Hz	V	V	V
		@120Hz	V	V	V
UWQHD	3440x1440	@50Hz	V		
		@60Hz		V	V
		@100Hz	V	V	V
		@120Hz		V	V
Video Timing Resolution	720P		V	V	V
	1080P	@60Hz	V	V	V
		@120Hz	V	V	V
	2160P	@30Hz	V		
		@60Hz	V		
	2560x1080p	@60Hz	V		
		@120Hz	V		
	HDMI™ VRR*		V		

* HDMI™ VRR (Variable Refresh Rate) synchronizes with Adaptive-Sync (ON/ OFF). For VRR ON/OFF status, please check Adaptive-Sync.

Standard	Resolution		PIP Mode (Not Support HDR)		
			HDMI™	DP	USB-C
QHD	2560x1440	@60Hz	V	V	V
		@120Hz	V	V	V
UWQHD	3440x1440	@50Hz	V		
		@60Hz		V	V
		@100Hz	V	V	V
		@120Hz		V	V
Video Timing Resolution	720P		V	V	V
	1080P	@60Hz	V	V	V
		@120Hz	V	V	V
	2560x1080p	@60Hz	V		
		@120Hz	V		

Standard	Resolution		PBP Mode (Not Support HDR)		
			HDMI™	DP	USB-C
QHD	2560x1440	@60Hz	V	V	V
Video Timing Resolution	720P		V	V	V
Special EDID for PBP used	1740x1440	@60Hz	V	V	V

Troubleshooting

The power LED is off.

- Press the monitor power button again.
- Check if the monitor power cable is properly connected.

No image.

- Check if the computer graphics card is properly installed.
- Check if the computer and monitor are connected to electrical outlets and are turned on.
- Check if the monitor signal cable is properly connected.
- The computer may be in Standby mode. Press any key to activate the monitor.

The screen image is not properly sized or centered.

- Refer to Preset Display Modes to set the computer to a setting suitable for the monitor to display.

No Plug & Play.

- Check if the monitor power cable is properly connected.
- Check if the monitor signal cable is properly connected.
- Check if the computer and graphics card are Plug & Play compatible.

The icons, font or screen are fuzzy, blurry or have color problems.

- Avoid using any video extension cables.
- Adjust brightness and contrast.
- Adjust RGB color or tune color temperature.
- Check if the monitor signal cable is properly connected.
- Check for bent pins on the signal cable connector.

The monitor starts flickering or shows waves.

- Change the refresh rate to match the capabilities of your monitor.
- Update your graphics card drivers.
- Keep the monitor away from electrical devices that may cause electromagnetic interference (EMI).

Safety Instructions

- Read the safety instructions carefully and thoroughly.
- All cautions and warnings on the device or User Guide should be noted.
- Refer servicing to qualified personnel only.

Power

- Make sure that the power voltage is within its safety range and has been adjusted properly to the value of 100~240V before connecting the device to the power outlet.
- If the power cord comes with a 3-pin plug, do not disable the protective earth pin from the plug. The device must be connected to an earthed mains socket-outlet.
- Please confirm the power distribution system in the installation site shall provide the circuit breaker rated 120/240V, 20A (maximum).
- Always disconnect the power cord or switch the wall socket off if the device would be left unused for a certain time to achieve zero energy consumption.
- Place the power cord in a way that people are unlikely to step on it. Do not place anything on the power cord.
- If this device comes with an adapter, use only the MSI provided AC adapter approved for use with this device.

Environment

- To reduce the possibility of heat-related injuries or of overheating the device, do not place the device on a soft, unsteady surface or obstruct its air ventilators.
- Use this device only on a hard, flat and steady surface.
- To prevent the device from tipping over, secure the device to a desk, wall or fixed object with an anti-tip fastener that helps to properly support the device and keep it safe in place.
- To prevent fire or shock hazard, keep this device away from humidity and high temperature.
- Do not leave the device in an unconditioned environment with a storage temperature above 60°C or below -20°C, which may damage the device.
- The maximum operating temperature is around 40°C.
- When cleaning the device, be sure to remove the power plug. Use a piece of soft cloth rather than industrial chemical to clean the device. Never pour any liquid into the opening; that could damage the device or cause electric shock.
- Always keep strong magnetic or electrical objects away from the device.

- If any of the following situations arises, get the device checked by service personnel:
 - The power cord or plug is damaged.
 - Liquid has penetrated into the device.
 - The device has been exposed to moisture.
 - The device does not work well or you can not get it working according to the User Guide.
 - The device has dropped and damaged.
 - The device has obvious sign of breakage.

TÜV Rheinland Certification

TÜV Rheinland Low Blue Light Certification

Blue light has been shown to cause eye fatigue and discomfort. MSI now offers monitors with TÜV Rheinland Low Blue Light certification to ensure users' eye comfort and well-being. Please follow the instructions below to reduce the symptoms from extended exposure to the screen and blue light.



Low Blue Light
(Software
Solution)

www.tuv.com

- Place the screen 20 – 28 inches (50 – 70 cm) away from your eyes and a little below eye level.
- Consciously blinking the eyes every now and then will help to reduce eye strain after extended screen time.
- Take breaks for 20 minutes every 2 hours.
- Look away from the screen and gaze at a distant object for at least 20 seconds during breaks.
- Make stretches to relieve body fatigue or pain during breaks.
- Turn on the optional Low Blue Light function.

TÜV Rheinland Flicker Free Certification

- TÜV Rheinland has tested this product to ascertain whether the display produces visible and invisible flicker for the human eye and therefore strains the eyes of users.
- TÜV Rheinland has defined a catalogue of tests, which sets out minimum standards at various frequency ranges. The test catalogue is based on internationally applicable standards or standards common within the industry and exceeds these requirements.
- The product has been tested in the laboratory according to these criteria.
- The keyword "Flicker Free" confirms that the device has no visible and invisible flicker defined in this standard within the range of 0 - 3000 Hz under various brightness settings.
- The display will not support Flicker Free when Anti Motion Blur/MPRT is enabled. (The availability of Anti Motion Blur/MPRT varies by products.)



Flicker Free

www.tuv.com

ENERGY STAR Certification

ENERGY STAR is a program run by the U.S. Environmental Protection Agency (EPA) and U.S. Department of Energy (DOE) to promote energy efficiency. This product qualifies for ENERGY STAR in the "factory default" settings through which power savings will be achieved. Changing the factory default picture settings or enabling other features will increase power consumption, which could exceed the limits necessary to qualify for ENERGY STAR rating.



For more information on ENERGY STAR, refer to <https://www.energystar.gov/>.

Regulatory Notices

CE Conformity

This device complies with the requirements set out in the Council Directive on the Approximation of the Laws of the Member States relating to Electromagnetic Compatibility (2014/30/EU), Low-voltage Directive (2014/35/EU), ErP Directive (2009/125/EC) and RoHS directive (2011/65/EU). This product has been tested and found to comply with the harmonized standards for Information Technology Equipment published under Directives of Official Journal of the European Union.



FCC-B Radio Frequency Interference Statement

This equipment has been tested and found to comply with the limits for a Class B digital device, pursuant to Part 15 of the FCC Rules. These limits are designed to provide reasonable protection against harmful interference in a residential installation. This equipment generates, uses and can radiate radio frequency energy and, if not installed and used in accordance with the instruction manual, may cause harmful interference to radio communications. However, there is no guarantee that interference will not occur in a particular installation. If this equipment does cause harmful interference to radio or television reception, which can be determined by turning the equipment off and on, the user is encouraged to try to correct the interference by one or more of the measures listed below:



- Reorient or relocate the receiving antenna.
- Increase the separation between the equipment and receiver.
- Connect the equipment into an outlet on a circuit different from that to which the receiver is connected.
- Consult the dealer or an experienced radio/television technician for help.

Notice 1

The changes or modifications not expressly approved by the party responsible for compliance could void the user's authority to operate the equipment.

Notice 2

Shielded interface cables and AC power cord, if any, must be used in order to comply with the emission limits.

This device complies with Part 15 of the FCC Rules. Operation is subject to the following two conditions:

1. This device may not cause harmful interference, and
2. This device must accept any interference received, including interference that may cause undesired operation.

MSI Computer Corp.

901 Canada Court, City of Industry, CA 91748, USA

(626) 913-0828

www.msi.com

WEEE Statement

Under the European Union ("EU") Directive on Waste Electrical and Electronic Equipment, Directive 2012/19/EU, products of "electrical and electronic equipment" cannot be discarded as municipal waste anymore and manufacturers of covered electronic equipment will be obligated to take back such products at the end of their useful life.



Chemical Substances Information

In compliance with chemical substances regulations, such as the EU REACH Regulation (Regulation EC No. 1907/2006 of the European Parliament and the Council), MSI provides the information of chemical substances in products at: <https://csr.msi.com/global/index>

RoHS Statement

Japan JIS C 0950 Material Declaration

A Japanese regulatory requirement, defined by specification JIS C 0950, mandates that manufacturers provide material declarations for certain categories of electronic products offered for sale after July 1, 2006. <https://csr.msi.com/global/Japan-JIS-C-0950-Material-Declarations>

India RoHS

This product complies with the "India E-waste (Management and Handling) Rule 2016" and prohibits use of lead, mercury, hexavalent chromium, polybrominated biphenyls or polybrominated diphenyl ethers in concentrations exceeding 0.1 weight % and 0.01 weight % for cadmium, except for the exemptions set in Schedule 2 of the Rule.

Turkey EEE Regulation

Conforms to the EEE Regulations of the Republic Of Turkey

Ukraine Restriction of Hazardous Substances

The equipment complies with requirements of the Technical Regulation, approved by the Resolution of Cabinet of Ministry of Ukraine as of 10 March 2017, № 139, in terms of restrictions for the use of certain dangerous substances in electrical and electronic equipment.

Vietnam RoHS

As from December 1, 2012, all products manufactured by MSI comply with Circular 30/2011/TT-BCT temporarily regulating the permitted limits for a number of hazardous substances in electronic and electric products.

Green Product Features

- Reduced energy consumption during use and stand-by
- Limited use of substances harmful to the environment and health
- Easily dismantled and recycled
- Reduced use of natural resources by encouraging recycling
- Extended product lifetime through easy upgrades
- Reduced solid waste production through take-back policy

Environmental Policy

- The product has been designed to enable proper reuse of parts and recycling and should not be thrown away at its end of life.
- Users should contact the local authorized point of collection for recycling and disposing of their end-of-life products.
- Visit the MSI website and locate a nearby distributor for further recycling information.
- Users may also reach us at gpcontdev@msi.com for information regarding proper disposal, take-back, recycling, and disassembly of MSI products.



Warning!

Overuse of screens is likely to affect eyesight.

Recommendations:

1. Take a 10-minute break for every 30 minutes of screen time.
2. Children under 2 years of age should have no screen time. For children aged 2 years and over, screen time should be limited to less than one hour per day.

Copyright and Trademarks Notice

Copyright © Micro-Star Int'l Co., Ltd. All rights reserved. The MSI logo used is a registered trademark of Micro-Star Int'l Co., Ltd. All other marks and names mentioned may be trademarks of their respective owners. No warranty as to accuracy or completeness is expressed or implied. MSI reserves the right to make changes to this document without prior notice.



The terms HDMI™, HDMI™ High-Definition Multimedia Interface, HDMI™ Trade dress and the HDMI™ Logos are trademarks or registered trademarks of HDMI™ Licensing Administrator, Inc.

Technical Support

If a problem arises with your product and no solution can be obtained from the user's manual, please contact your place of purchase or local distributor. Alternatively, please visit <https://www.msi.com/support/> for further guidance.

Ovaj dokument je originalno proizveden i objavljen od strane proizvođača, brenda MSI, i preuzet je sa njihove zvanične stranice. S obzirom na ovu činjenicu, Tehnoteka ističe da ne preuzima odgovornost za tačnost, celovitost ili pouzdanost informacija, podataka, mišljenja, saveta ili izjava sadržanih u ovom dokumentu.

Napominjemo da Tehnoteka nema ovlašćenje da izvrši bilo kakve izmene ili dopune na ovom dokumentu, stoga nismo odgovorni za eventualne greške, propuste ili netačnosti koje se mogu naći unutar njega. Tehnoteka ne odgovara za štetu nanесenu korisnicima pri upotrebi netačnih podataka. Ukoliko imate dodatna pitanja o proizvodu, ljubazno vas molimo da kontaktirate direktno proizvođača kako biste dobili sve detaljne informacije.

Za najnovije informacije o ceni, dostupnim akcijama i tehničkim karakteristikama proizvoda koji se pominje u ovom dokumentu, molimo posetite našu stranicu klikom na sledeći link:

<https://tehnoteka.rs/p/msi-zakrivljeni-monitor-34-va-modern-md342cqp-akcija-cena/>