

Uputstvo za upotrebu (EN)

HISENSE displej 43" Digital Signage 43DM66D

Hisense



Tehnoteka je online destinacija za upoređivanje cena i karakteristika bele tehnike, potrošačke elektronike i IT uređaja kod trgovinskih lanaca i internet prodavnica u Srbiji. Naša stranica vam omogućava da istražite najnovije informacije, detaljne karakteristike i konkurentne cene proizvoda.

Posetite nas i uživajte u ekskluzivnom iskustvu pametne kupovine klikom na link:

<https://tehnoteka.rs/p/hisense-displej-43-digital-signage-43dm66d-akcija-cena/>

Hisense

32/43/50/55/65/75/86DM66D

32/43/50/55/65/75/86/100DM66E

USER MANUAL

Read the manual carefully and ensure you have fully understood its contents before operating this device for the first time.



Declaration

Any content and service accessed through this device, while only intended for individual non-commercial use, shall be the property of the applicable third party and subject to protection by regulations and laws on copyright, patent, trademark and other intellectual property rights. No part of such content and service may be modified, duplicated, published, uploaded, distributed, translated, marketed, or used to make and distribute products derived from it without the prior permission of the content owner or service provider.

You acknowledge and agree explicitly that you will solely bear the risk associated with the use of this device, and further you will solely bear any risk related to satisfactory quality, performance and accuracy for any content and service accessed through this device. To the maximum extent permitted by applicable law, this device and any third party's content and service is provided as it is without any guarantee, express or implied.

Manufacturer hereby declare explicitly that Manufacturer shall not be held liable for any guarantee and conditions, express or implied, related to this device and any content and service, including but not limited to warranty on marketability, satisfactory quality, fitness for a particular purpose, accuracy, quiet use and non-violation of any third party's rights; to the maximum extent permitted by applicable law, Manufacturer gives no guarantee on the accuracy, validity, timeliness, legitimacy and completeness of any content or service provided through this device, or the fitness of such device, content or service for your particular requirement, or the protection from interruption and error during operation of such device, content or service; to the maximum extent permitted by applicable law, in any case, including fault or neglect, Manufacturer shall not be held liable for legal actions or indemnity obligation arising from any consequence as a result of or related to any information loaded in this device or use of such device, content or service by you or any third party .

Any content and service provided as it is together with this device shall be the property of the applicable third party, therefore Manufacturer gives no declaration or warranty on modification, suspension, cancellation, termination or abortion thereof, and shall not be held liable for legal actions or indemnity obligation arising thereof.

Manufacturer reserves the rights to restrict the use or access of certain content or service. As the content and service are transmitted through third party's network and transmission facilities, Manufacturer undertakes no customer service thereof or the obligation for such customer service.

【Statement】

- The pictures and instructions in this user manual are for reference only, and may be different from the actual product. Please subject to the actual product. (This statement is throughout this User Manual)
- Quality upgrades, product design and specifications are subject to change without notice.
- The software content service applicable to this product depends on the third party provider, and some software may not be used due to network, region, service cycle and other problems, which has nothing to do with the product quality. Please contact the third party provider for relevant details.



Important Safety Precautions



This symbol alerts user about the presence of a dangerous voltage not isolated inside the product which can be sufficiently powerful to constitute a risk of electrocution.



This symbol alerts user about the presence of important operating instructions and maintenance in the document enclosed in the package.



ATTENTION

RISK OF SHOCK
ELECTRIC



Do not open the back cover.
In no case the user is allowed to operate inside the device.
Only a qualified technician is entitled to operate.



AC voltage: This symbol indicates that the rated voltage marked with the symbol is AC voltage.



DC voltage: This symbol indicates that the rated voltage marked with the symbol is DC voltage.



Class I product: 75"/86"/100" requires a safety connection of protective earthing (ground).

Disposal of Used Electrical & Electronic Equipment



Packaging and electrical goods should be recycled appropriately, and not treated as household waste. Please dispose of this equipment at your applicable collection point for the recycling of electrical & electronic equipment waste. By ensuring the correct disposal of this product, you will help prevent potentially hazardous to the environment and to human health, which could otherwise be caused by unsuitable waste handling of this product. The recycling of materials will help conserve natural resources. Please do not therefore dispose of your old electrical and electronic equipment with your household waste. For more detailed information about recycling of this product, please contact your local city office, your household waste disposal service or the shop where you purchased the product.

Stability Hazard

Warning!

The device set may fall, causing serious personal injury or death. To prevent injury, this device set must be securely attached to the wall in accordance with the installation instructions.

Safeguards

Please read the following safeguards for your device and retain for future reference. Always follow all warnings and instructions marked on the device.

1. A note about safety and operating instructions

Read and follow all safety and operating instructions, and retain them safely for future reference.

2. Heed Warnings

Adhere to all warnings on the appliance and in the operating instructions.

3. Cleaning

Unplug the device from the wall outlet before cleaning. Do not use liquid, abrasive, or aerosol cleaners. Cleaners can permanently damage the cabinet and screen. Use a lightly dampened cloth for cleaning.

4. Water and Moisture

Avoid dripping or splashing of liquids onto the product. Objects filled with liquids, such as vases, should not be placed on the product.

5. Ventilation

Slots and openings in the cabinet are provided for ventilation, to ensure reliable operation of the device and to protect it from overheating. Do not cover the ventilation openings in the cabinet and never place the set in a confined space such as built-in cabinet unless proper ventilation is provided. Leave a minimum 10cm gap all around the unit.

6. Power Source

This device should be operated only from the type of power source indicated on the marking label. If you are not sure of the type of power supplied to your home, consult your appliance dealer or local power company.

7. Power-Cord Protection

Power- supply cords should be routed so that they are not likely to be walked on or pinched by items placed upon or against them, paying particular attention to cords at plug, wall outlets, and the point where they exit from the device. MAIN plug is used as the disconnect device, the disconnect device shall remain readily operable.

8. Lightning

For added protection for this device during a lightning storm, or when it is left unattended and unused for long periods of time, unplug it from the wall outlet and disconnect the cable system. This will prevent damage to the device due to lightning or power-line surge.

9. Overloading

Do not overload wall outlets and extension cords as this can result in a risk of fire or electric shock.

10. Object and Liquid Entry

Never push objects of any kind into this device through openings as they may touch dangerous voltage points or short-out parts that could result in fire or electric shock. Never spill liquid of any kind on or into the device.

11. Servicing

Do not attempt to service this device yourself as opening or removing covers may expose you to dangerous voltage or other hazards. Refer all servicing to qualified service personnel.

12. Damage Requiring Service

Unplug the device from the wall outlet and refer servicing to qualified service personnel under the following conditions:

- (a) When the power - supply cord or plug is damaged.
- (b) If liquid has been spilled, or objects have fallen into the device.
- (c) If the device has been exposed to rain or water.
- (d) If the device does not operate normally by following the operating instructions.
Adjust only those controls that are covered by the operating instructions as an improper adjustment of other controls may result in damage and will often require extensive work by a qualified technician to restore the device to its normal operation.
- (e) If the device has been dropped or the cabinet has been damaged.
- (f) When the device exhibits a distinct change in performance - this indicates a need for service.

13. Replacement Parts

When replacement parts are required, be sure the service technician has used replacement parts specified by the manufacturer or have the same characteristics as the original part. Unauthorized substitutions may result in fire, electric shock or other hazards.

14. Safety Check

Upon completion of any service or repair to the device, ask the service technician to perform safety checks to determine that the device is in safe operating condition.

15. Heat

The product should be situated away from heat sources such as radiators, heat registers, stoves, or other products (including amplifiers) that produce heat.

16. Fire

The product should be situated away from naked flame sources such as lighted candle.

17. Off-gassing

The device smells of plastic is normal and will dissipate over time.



Incorrect replacement of the battery may lead to the risk, including the replacement of another similar or the same type. Do not expose batteries to heat such as sun or fire or something like that.



The device should not be exposed to dripping and spraying and it cannot be placed under objects filled with liquids.



MAIN plug on the power cord is used as the disconnect device, the disconnect device and socket-outlet shall be easily accessible.



Apparatus with CLASS I construction(75"/ 86") shall be connected to a MAINS socket outlet with a protective earthing connection.

【Note】

Still images may cause permanent damage to the screen of the unit.

1. Do not display still images on the LCD screen for more than 2 hours, because this will cause residual images on the screen, in order to avoid this problem, please reduce the brightness and contrast of the screen when displaying still images.
2. When watching a program in 4:3 format for a long time, it will leave different marks on the left and right sides of the screen and the edges of the image, so please do not use this mode for a long time.
3. If the still image of video games and computers is displayed for too long, it may cause local afterimages and residual images caused by the burn of the phosphor screen, so please reduce the brightness and contrast appropriately when using it.

The display screen caused by the above reasons has image residual images, local afterimages, and traces problems, and the display screen is not covered by the warranty.



Start Guide

Precautions for Installation

- As shown in the figure below, leave a ventilation space around the device.

When mounted on the wall:

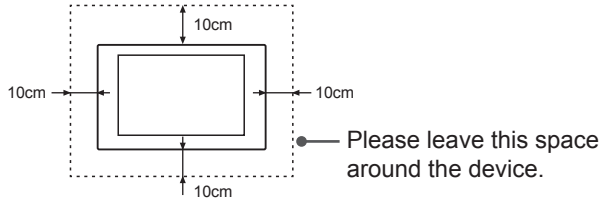

- Do not install the device as shown below.

Hinder air circulation

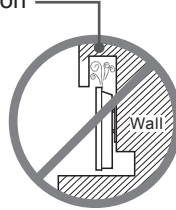

Insufficient ventilation will overheat the device and may cause damage to the device and even fire.



CONTENTS

CONTENES.....	1
Accessories List.....	2
Wall Mount (Optional).....	2
Remote Control	6
Control Panel.....	9
Terminal Introduction	10
Initial Startup.....	13
Setting	14
RS232.....	24
Miscellaneous.....	34
Specifications	35

1

Accessories List

NOTE

- Items may differ in different locations
- Display design and accessories may differ from the images shown.

Remote Control × 1

Battery(AAA) × 2

Quick Setup Guide × 1

Warranty Card×1(Optional)

RS232 Converter Cable ×1(Optional)

Power Cord (It depends on the regions or countries.)

Logo ×1(Optional) (100")

Wall Mount Spacer ×4 (100")

2

Wall Mount (Optional)

1. Before installing the wall-mount bracket, first place the machine on a secure and clean desktop with soft protective cloth. Confirm that the desktop is solid and reliable since the machine is heavy.
2. Remove the wall-mount screws in the wall-mount holes of the rear shell. (Ignore this step in the absence of wall-mount screws.) Fix wall mounted vertical beams with screws of the specifications specified in the user manual.
3. To avoid damage of the machine, please install the wall mount strictly in the sequence of rollers, wall-mount bracket and wall-mount screws.
4. Before hanging the machine, please confirm that the wall-mount bracket is installed securely without looseness.
5. Slowly peel off the protective tape around the front shell. (32"/43"/50"/55"/65"/75"/86")

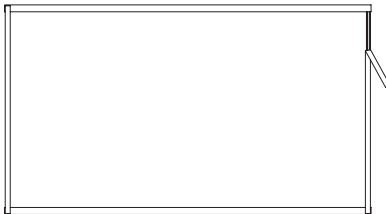

6 Slowly peel off the panel protective film on the machine by folding it 180 degrees along the torn film label. (32"/43"/50"/55"/65"/75"/86")

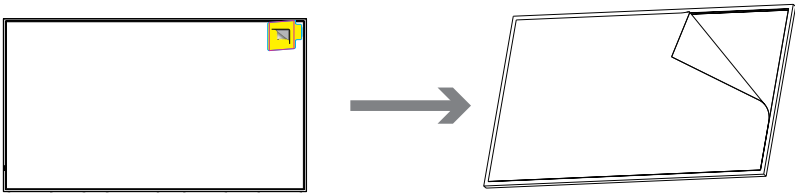

【Statement】

- 32"/43"/50"/55"/65"/75"/86"

To use this device in portrait mode, rotate it counterclockwise in reverse until the power indicator light is as shown in the following figure.

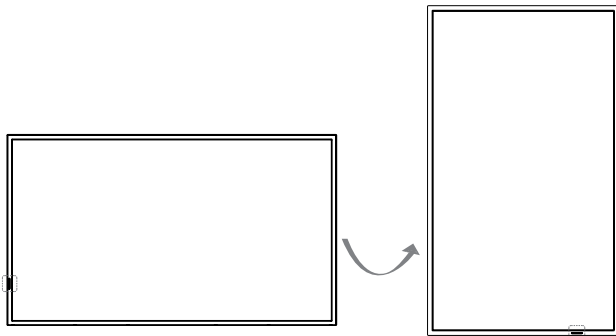

- 100"

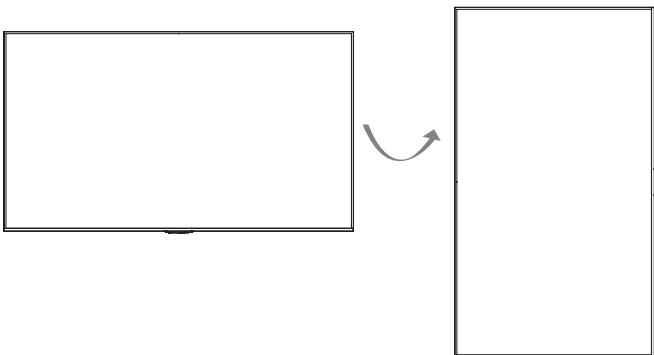

【Note】

- 32"/43"/50"/55"/65"/75"/86"

This device can tilt up to 15 degrees forward from a vertical wall.

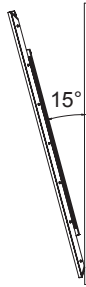

- The pictures are for reference only. For detailed information on installing wall mounted brackets, please refer to the manual provided with the wall mounted bracket.

【Note】

- This machine is used in conjunction with Hisense LG400030D (32"/43"/50"/55"/65") / LG60060BE (75"/86") / LG100060BE (100") wall mounted brackets; Using non designated wall mounted brackets together may cause instability and injury. Product defects caused by unauthorized installation by Hisense are not covered by the warranty.
- If installation instructions are not followed or non Hisense authorized installation services or accessories are used, there may be safety hazards (including but not limited to product falling or falling off) and personal injury or property damage may occur. Such damage or loss is not caused by Hisense Company and should be borne by the corresponding party at fault.
- When using wall mounted installation, to avoid damage to the device or personal injury, please install at an angle of less than 15 ° on a vertical wall.

32"/43"/50"/55"/65"/75"/86"

VESA wall mount standard (mm)	200×200 (32") 300×300 (43"/50"/55") 400×400 (65") 600×400 (75"/86")
Diameter of wall-mount screw (mm)	M6
Number of wall-mount screw	4

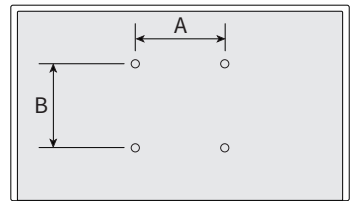

Schematic diagram of wall mounting holes

100"

Horizontal:

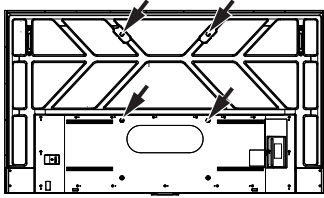

Vertical:

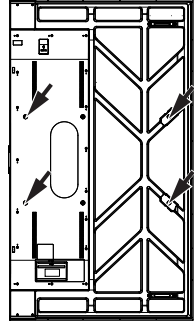

VESA wall mount standard (mm)	Horizontal: 600×600 Vertical: 1000×600
Diameter of wall-mount screw (mm)	M8
Number of wall-mount screw	4

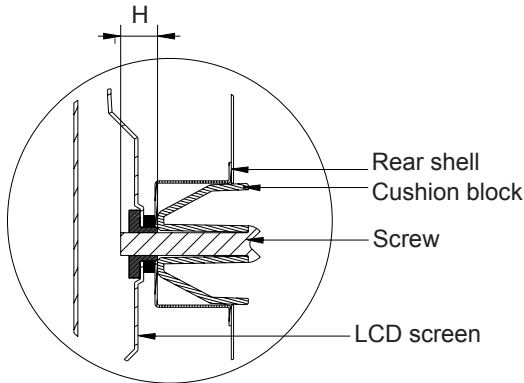

































【Note】

- Only the installation specification of the wall mount is described here; the appearance of rear shell is for schematic purpose only.
- The screw installation depth in the wall-mount holes of the rear shell , H is : 8.0-10.0mm(32"); 12.0-13.0mm(43"/75"/86"); 11.0-12.5mm(50"/55"/65"); 11.0-13.0mm(100") overlong screws will cause irreparable damage to the equipment.
- If the intactness of the machine cannot be guaranteed during wall mounting, please contact professional installation personnel or technical support personnel.
- This wall mount is suitable for concrete and brick walls. For plank and plasterboard walls, special reinforcement is required instead of directly using the wall mount. Ensure that a single expansion bolt fixed in the wall can bear over 1/3 of the overall weight of the machine.

3

Remote Control

Button name	Button	Description
Power		Power on/off
Source		Input source menu
0-9	 - 	Number buttons. Use to enter a PIN, enter a Date, etc.
*		
#		
Rewind		Video playback page: rewind
Stop		Video playback page: stop
Play		Video play page: pause Video pause page: play
Forward		Video playback page: forward
Lock		Unlock the remote control Key combination: lock+ok+ok+lock
Setting		Call the Settings menu
Up		Move to the upper menu
Down		Move to the lower menu
Left		Move to the left menu
Right		Move to the right menu
OK	ok	Confirm a menu selection.
Back		Back to the previous menu
Exit		Exit the current page
Volume +	+	Increase the volume by 1 and pop up the volume bar
Volume -	-	Decrease the volume by 1 and pop up the volume bar
Home		A shortcut button to Home screen
Mute/Unmute		Mute on: pop up the mute icon Mute off: The mute icon disappears and the current volume is displayed.

BRI+		Setting – Display - Picture mode -Customization – Black grade
BRI -		
APPS		Open all apps
White Balance		Setting – Display – Advanced setting – White balance
Device Info		Setting – System – About
File Manager		Open File Manager
VisionInfo		Open VisionInfo
Menu		<ol style="list-style-type: none"> 1. In All Apps, Media Center and Media Autoplay pages, press "Menu" button to enter editing mode; 2. Press "menu"button on other pages to call out the shortcut menu.
Mutil-Screen		Setting – Display – Multi-screen display
Browser		Open browser
Backlight		Setting – Display - Brightness
Screen Rotation		Setting – Display – Screen rotation
Network		Setting - Network
Sound mode		Setting – Sound – Sound mode

Battery replacement method

1. Please open the battery cover by separating it from the remote control body at the battery cover grommet.
2. Load two #7 1.5V alkaline batteries, noting that the positive (+) and negative (-) terminals of the batteries must match the positive (+) and negative (-) terminals in the battery compartment.
3. Close the battery cover from the bottom to the top until it fits perfectly into the remote control body.

Effective range

1. Remote Control Distance : Remote control is effective within 8 metres from the front.
2. Remote control angle: Take the remote control receiving window of this machine as the apex, at a distance of 6 metres, the controlled angle is not worse than ± 30 degrees in the left-right direction, and not worse than ± 15 degrees in the vertical up-down direction.

【Note】

- Replace the batteries if the remote control does not operate properly, is unstable or cannot control the unit remotely.
- If you do not use the remote control for a long time or if the batteries are exhausted, please remove the batteries. (Used batteries pollute the environment, so please dispose of them properly.)
- In order to achieve the best remote control reception effect, please point the remote control transmitter window to the remote control receiver window position of this unit for remote control operation.

4

Control Panel

32"/43"/50"/55"/65"/75"/86"

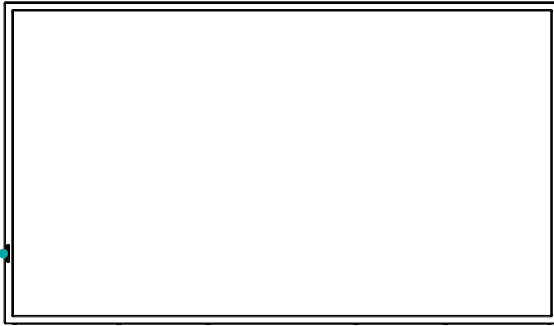

Remote sensor / Power indicator

100"

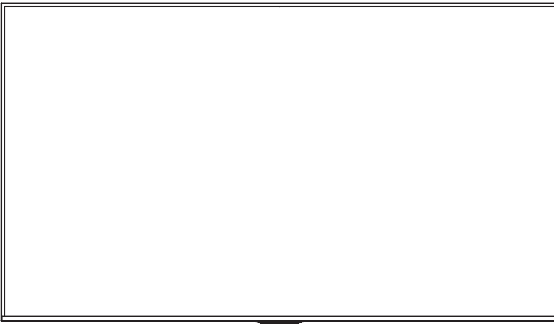

Remote sensor / Power indicator

Name/Operation	Function
Remote receiver	Receive signals transmitted by the remote control via this window.
Indicator	When the machine is on, the indicator light is white; when it enters sleep mode, the indicator light is red. (32"/43"/50"/55"/65"/75"/86") When the machine is on, the indicator light is white; when it enters sleep mode, the indicator light is off. (100")

[Note]

- The appearance is subject to the actual product.
- Since power outage and system processing takes some time, DO NOT power on and off the machine in rapid succession; otherwise the machine may work abnormally.

5

Terminal Introduction

32"/43"/50"/55"/65"/75"/86"

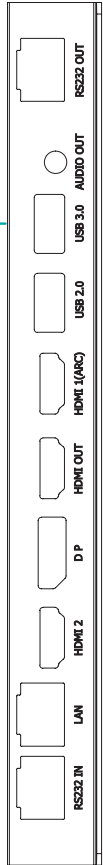
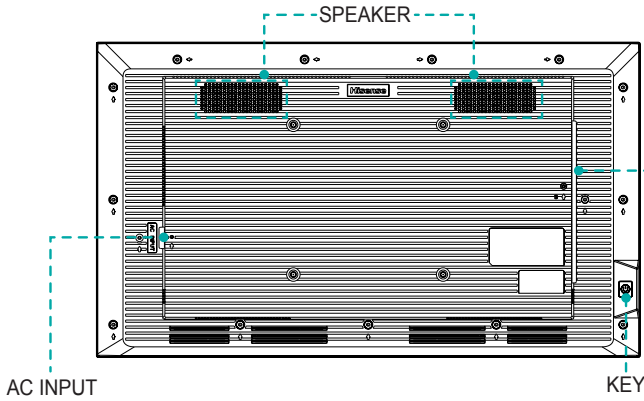

[Note]

- The rear view is for reference only, please subject to the actual product.
- RS232 port: It is for serial communication control of the machine.
- It is possible that some external devices cannot be connected to the machine due to individual difference. In such case, please replace the signal line with a suitable one or add an adapter cable matching the port.

100"

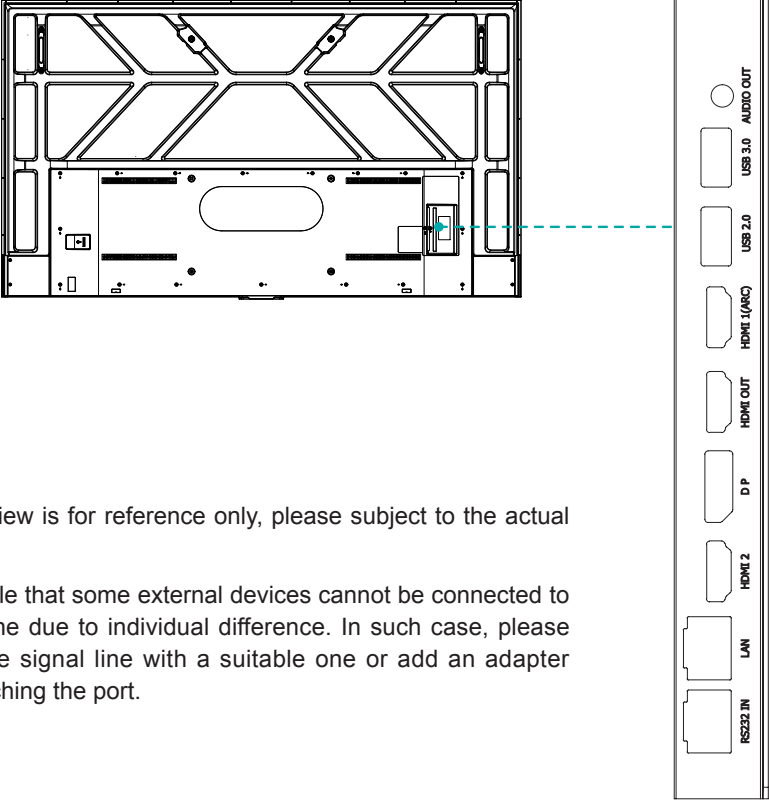

[Note]

- The rear view is for reference only, please subject to the actual product.
- It is possible that some external devices cannot be connected to the machine due to individual difference. In such case, please replace the signal line with a suitable one or add an adapter cable matching the port.

Port Name	Function descriptionunction
USB2.0	USB standard port is provided with this machine; it can also be used to connect a standard USB2.0 device, such as hard disk drive and USB flash drive.
USB3.0	USB standard port is provided with this machine; it can also be used to connect a standard USB2.0/USB3.0 device, such as hard disk drive and USB flash drive.
HDMI1(ARC)	It can be used to connect an external device with HDMI port, such as STB, player, or PC with HDMI output.
HDMI2	It can be used to connect an external device with HDMI port, such as STB, player, or PC with HDMI output.
HDMI OUT	When HDMI2 or DP has signal input, HDMI OUT can output HDMI2 or DP input signals; it can be used to connect other display device with HDMI port.
LAN	It can be used to connect a network cables so as to access the Internet.
RS232 OUT	It is the output port of the serial communication command. [Note] Different models may have variations in terminals, please refer to the actual model.
RS232 IN	It is the input port of the serial communication command.
AUDIO OUT	It can be used to connect a headphone.
DP	It can be used to connect an external device with DP port.



[Note]

- The rear view is for reference only, subject to the actual product.
- It is possible that some external devices cannot be connected to the machine due to individual difference. In such case, please replace the signal line with a suitable one or add an adapter cable matching the port.

6

Initial Startup

1 Startup/Shutdown

- Connect the power cord of the machine to a 100-240V AC power outlet.
- In power-on state, press the **STANDBY key**  on the remote control; the machine will enter sleep mode. To watch normally, simply press again the **STANDBY key**  on the remote control.

[Note]

- After pull off the power cord, there should be an interval of at least 5s before restart to prevent abnormality of the machine.

2 Adjust Local Settings

Use of the setting function can satisfy your different needs and allow you to fully enjoy the audiovisual effect brought by the machine.

You can adjust image and sound, set network connection and perform other operations from here.

- In menus at different levels, you can perform the following operations using the remote control:
 - Press the **arrow keys** to select each option
 - Press the **OK key** to confirm operation or enter the sub-menu
 - Press the **LEFT/RIGHT key** to adjust values
 - Press the **UP/DOWN key** to adjust options
- Press the **↶ key** to go back to the previous menu.

7

Setting

1 Calling Methods:

Press the  **SETTING** button on the remote control to enter the setting interface.

2 Setting:

Network

2nd	3rd	Description
Ethernet	Automatic IP acquisition	-Wired priority, connects automatically when wired is plugged in. -Cannot be turned on when not connected to a wired network. -By default, the IP address is obtained automatically.
	Manual IP	Users are connected to a wired network and can also manually configure an IP address for Internet access.
	MAC address	Showcase a wired Mac
Wi-Fi	On/Off	The wireless network has two states: on and off, and is on by default.
	MAC address	Showcase Wireless Mac Address
	Available network	Display a list of currently connectable WiFi. -The WiFi list is automatically refreshed every 10s. -Shows the current status of each SSID: Connected, Not Connected or No Internet Access. -For connected networks, click to view the IP address (including the IPV6 address) or to disconnect; for unconnected networks, click to enter a password to connect, or open the Advanced Settings and select Manual Settings.
	Add other network	Manually add the network you want to connect to.
Network Diagnostic		Detects the current network connection status.

Hotspot	On/Off	-The hotspot has two states, on and off, and is off by default. -Note: Hotspot and wireless network are mutually exclusive, i.e., if the hotspot is on, the wireless network is automatically off if it is on;
	Name and password	Enter the name and password of the hotspot you want to connect to
	Advanced setting	Users can select the encryption method and channel in the advanced settings
Bluetooth	On/Off	Bluetooth has both on and off states, and is off by default.
	Paired devices	-Show paired devices. -Note: Users can click on the device to cancel the pairing.
	Available devices	-Show the list of currently searched Bluetooth devices. -Note: Users can perform pairing operation by clicking the device.
	Search Equipment	Users can start the search function by clicking the "Available Devices" button to search for Bluetooth devices around them. Once a device is searched, it will be displayed in the "Available Devices" list.
Wi-Fi Display		-Support Miracast protocol. -Note: You need to open this page to search the device to cast screen.

Display

2nd	3rd	Description
Brightness		Backlight brightness, range 0-100
Auto adjust		Automatically adjusts the brightness of the whole backlight according to the light sense, and is on by default.
Image mode	Standard, Text, Bright, Natural, HDR	-Normal videos correspond to five image modes: Standard, Bright, Natural, Text, and Customization. -When HDR video is played back, the image mode automatically switches to HDR standard mode.

Image mode	Customization	<p>-Black Level: This parameter has a value range of 0-100 and is used to describe the degree of black expression in the image.</p> <p>-Contrast: The value of this parameter ranges from 0 to 100 and is used to describe the contrast between light and dark of the image.</p> <p>-Chroma: The value of this parameter ranges from 0 to 100, and is used to describe the degree of colour performance of the image.</p> <p>-Sharpness: The value of this parameter ranges from 0 to 20, which is used to describe the degree of detail performance of the image.</p> <p>-Colour Temperature: This parameter has five grades, namely, Cool, Cooler, Standard, Warmer and Warmer, which are used to describe the tonal performance of the image.</p> <p>-Noise Reduction: This parameter has four levels, namely Off, Low, Medium and High, and the default level is Medium, which is used to describe the degree of noise reduction of the image.</p>
Screen rotation	Landscape	-Rotation of the whole machine content, i.e. the signal display is rotated synchronously with the menu display.
	Vertical	-Provides two angles, lanscape and vertical, the default is lanscape .
Menu rotation	Landscape	-Only menu shows rotation.
	Vertical	-Provides both lanscape and vertical angles, default lanscape.
Screen saver	Screen burn protection	On, Off, Off by default.
	Periodic execution	Interval Screen burn protection execution cycle
	Mode	Pixel, scroll bar, gradient screen. Default Pixel.
	Start time	Anti-burn mode start time
	End time	Anti-burn mode end time

[Note]

The functions of different models may vary, please refer to the actual model.

Advanced setting	Zoom	-Landscape screen: full screen, standard, zoom 1, zoom 2, point to point. -Vertical screen: full screen, custom.
------------------	------	---

Dynamic Contrast	On, off, default on.
------------------	----------------------

Local Dimming	High, Medium, Low, Off.
---------------	-------------------------

[Note]

The functions of different models may vary, please refer to the actual model.

Luminance dynamic range	Auto, Limit, All, default Auto.
-------------------------	---------------------------------

White balance	Users can adjust the white balance of the video image -2-point and 10-point white balance can be selected for adjustment; -2-point white balance adjusts the white balance sub-items of the image: red gain, green gain, blue gain, red deviation, green deviation, blue deviation. The adjustment range is (-30 --- +30), and the default is 0. -10-point white balance adjusts the image's options including LEVEL selections: 1-10; red, green, blue, with an adjustment range of (-30 --- +30) and a default of 0.
---------------	---

Gamma	-Adjust the centre brightness of the image. -The user has the option to turn gamma on or off. Sub options include: 1.8, 2.0, 2.2, 2.4.
-------	---

Colour correction	Users can adjust the colour of the video image. 1. Adjustment sub-items: red, green, blue, cyan, yellow, purple, skin tone hue, colour saturation, brightness options. 2. Adjustment range (-15 --- +15), default is 0. 3. The setting effect takes effect instantly.
-------------------	--

Multi-screen display	Used in multiple screen splicing scenarios. 1. Set the position and display content of each screen through the four options of "Horizontal Ratio", "Vertical Ratio", "Screen Position" and "Edge Masking". Set the position and display content of each screen; 2. Horizontal and vertical settings for the number of rows and columns of the splicing settings, the default is 1 row and 1 column, range 1-15. 3. Screen Position is the position of the row and column where the screen is located. 4. Edge Masking Setting sub-option for On and Off, default Off, when turned on, the splicing position image is used to crop off.
----------------------	--

Image parameter reset	Rest preset values for image settings.
-----------------------	--

Sound

2nd	3rd	Description
Sound mode	Standard, Cinema, Music, Meeting, Customization	Users can adjust several sound modes preset by the unit: standard, cinema, music, meeting, customization. 1.Default standard. 2.Custom support 5-band equalisation adjustment: 120Hz, 500Hz, 1.5kHz, 5kHz, 10kHz.
Output device	Device speakers, HDMI ARC, USB sound equipment	Users can adjust the sound output device selection. 1. Output devices include: device speakers, HDMI ARC, Bluetooth devices, USB audio devices 2. Default native speakers. When a device type is selected, other types of audio devices do not output sound
Advanced setting	Automatic volume control	Users can adjust the automatic volume control switch. 1. Adjustment items: on, off, default is off.
	Balance	Users can adjust the left/right balance of the sound output. 1. Adjustment range -10 to 10, default 0.
	Maximum Volume/ Minimum Volume	Users can set the maximum and minimum volume.
	Sound parameter reset	Users has the option to restore the sound settings to the factory preset state.

Switch on/off

2nd	3rd	Description
Switch-on source	Memory, Home, HDMI1, HDMI2, DP, Media Autoplay	1. Media autoplay option is displayed according to the playlist, it is not displayed when the playlist is empty. 2. Default boot source is home.
Power on mode	Boot, Standby, Last	Default boot.

Wake-on LAN	Switch on, switch off	Users can wake up the whole machine through wired network. 1. When it is on, you can wake up the whole machine through the network, and off, you can't wake up. 2. Off by default.
Sleep mode settings	Switch on, switch off	Users can set whether or not to enter the hibernation state through the hibernation menu.
Turn-on delay	Switch on, switch off	Sets the power-on delay default value. Setting range 2-255s.
Timed switch on/off	Boot, Shutdown	Users can activate and deactivate the timer on/off function. The clock sets hours and minutes in a 24-hour manner, and up to three different switch-on/switch-off time points can be set per day (each switch is a time period).
No signal standby	Off, 30S, 1 minute, 5 minutes, 10 minutes, 15 minutes, 30 minutes, 60 minutes	Automatic standby with no signal from the source. Default 10 minutes.
No operation standby	Off, 10 minutes, 15 minutes, 30 minutes, 60 minutes, 90 minutes, 120 minutes	Auto standby for Android without operation. Default 15 minutes.

Signal management

2nd	3rd	Description
Failover	switch on, switch off	<p>The sub-options contain On and Off, with Off being the default. When on, you can select master signal source and slave signal source.</p> <ol style="list-style-type: none"> 1. Among the channels supported by the whole machine, select two signal sources as master signal source and slave signal source; 2. When there is no signal from the master signal source and there is signal from the slave signal source, it will automatically jump to the slave signal source; 3. When there is no signal from the master signal source and no signal from the slave signal source, out of the no signal screen saver; 4. when the signal from the main signal source is restored, automatically switch to the main signal source; 5. When the master signal source is not restored and the slave signal source is restored, automatically switch to the slave signal source;
Auto switch source	switch on, switch off	<p>The device automatically switches channels when it detects a new signal access.</p> <p>Enabled by default.</p>
Automatic wake-up	switch on, switch off	<p>-Supports external signal for whole machine standby wake-up.</p> <p>-Enabled by default.</p> <p>-This option unifies the control of the standby wake-up function for HDMI and DP signals.</p>
HDMI version	HDMI standard, HDMI enhanced	Default HDMI standard

HDMI CEC	CEC switch	-On, off, default off. -When the control switch is on, the HDMI CEC control takes effect and the standby control, auto power on, and remote control switches are highlighted.
	Standby control	-On, off, default grey on. -When the whole machine is switched off by remote control, the external HDMI CEC device also enters the standby state.
	Automatic power-on	-On, off, default set grey on. -When switching on the whole machine, the CEC device will automatically switch on after receiving the command from the whole machine.
	Remote control	-On, off, default grey on. -Through the remote control, you can control the external HDMI CEC device, such as up, down, left, right, OK, return.
Homepage setting	Users can customise the homepage according to their needs. Supports browsers, Screen Cast (provided that the multi-screen interactive service lock is on) and installed third-party applications	
Serial port ID setting	-User can set the ID for serial communication through the setting menu. -ID setting data range is: 1-255.	

Application

2nd	3rd	Description
Application list Display all applications		Application information: icon, application name, version information, uninstall, force stop, total, application, data, delete data, cache, clear cache
Application permissions		After selecting an application, display the permissions currently applied for by the application
Application installation and uninstallation permissions		On, off, default on.

System

2nd	3rd	Description
Language	Simplified Chinese, English, French, German, Polish, Sipan, Russian, Italian, Finnish, Norwegian, Swedish, Israeli, Arabic, Thai, Malay, Bahasa Indonesia	-Switches the system language. -The default language is set according to the shipping country.
Input method	kika input method	Currently there is only one kika input method.
Country/Time zone selection		Select country and time zone
Time and date	Network synchronization	Select whether to enable network synchronisation of the system date and time.
	Date	Modify the system date.
	Time	Modify the system time.
Upgrade and update	Device upgrade	-Detect the availability of new system software versions through the network. -Performs an OTA upgrade of the entire system.
	USB upgrade and update	-Detect the availability of updatable system software through the USB port. -Upgrade the whole system.
	USB differential upgrade	Differential upgrade of the complete system via USB interface.
Over temperature protection	Device internal temperature	Display the internal temperature of the unit.
	Primary protection	On by default, automatically reduces backlight brightness by half when the temperature reaches 70 degrees Celsius.
	Secondary protection	(Forced on) Prompts to switch off when temperature reaches 90 degrees Celsius.
	Level 3 protection	(Forced on) Automatically switches off when the temperature reaches 100 degrees Celsius.
Reset		Restore all options and hard disc space of the device to the initial default state.
Disclaimer	User agreement	Displaying user agreement.
	Privacy policy	Showcasing the privacy policy.

About	Device name	-Display the name of the local machine. -The device name supports customisation.
	Serial number	Display the SN code of unit.
	Device ID	Display device ID.
	Android version	Display the current system Android version.
	System capacity	Display system capacity.
	Software version	Display the current system software version number.
	Wired MAC	Display wired mac.
	Wireless MAC	-Display the mac address after connecting to the wireless network. -Note: Display the default mac 02:00:00:00:00:00 when wireless is not connected.
	Bootling running time	Records and displays the power-on run time.
	Issue report	Export logs to a storage device via the USB port.

8

RS232

Serial Port State: When the serial port is open, the machine can receive serial port commands sent by the external controller. See the table below for the specific command protocol.

Data Parameters

DM-SERIES	
Baud Rate	9600
Data length (bits)	8
Parity	None
Stop bit	1
Flow control	None

Command Format

PC -> TV:

Header (2 Bytes)		Length (2 Bytes)		Command (4 Bytes)				Monitor ID (1 Byte)	Data (N Bytes)				Checksum (1 Bytes)	End (2 Bytes)	
DD	FF												BB	CC	

TV -> PC:

Header (2 Bytes)		Length (2 Bytes)		Command (4 Bytes)				Monitor ID (1 Byte)	Data (N Bytes)				Checksum (1 Bytes)	End (2 Bytes)	
AB	AB												CD	CD	

[Note]

- Length is the number of bytes of Command, Data and Checksum.
- Checksum is XOR of Length, Command, Monitor ID and Data.

RS232 Command

Description	Command (HEX Bytes)	Example (PC -> TV ID 01)	TV -> PC
Power On	DD FF 00 08 C1 15 00 00 xx BB BB yy BB CC	DDFF0008C115000001 BBBDBDBCC Tips: The range of this command's ID is 0x01- 0x34.	AB AB 00 08 C1 15 00 00 xx BB BB yy CD CD When TV is in standby state, send this command will get one feedback from TV, once TV starts up, it will send feedback again.
Power Off	DD FF 00 08 C1 15 00 00 xx AAAA yy BB CC	DD FF 00 08 C1 15 00 00 01 AAAA DD BB CC	AB AB 00 08 C1 15 00 00 xx AAAA yy CD CD
Screen Off	DD FF 00 07 C1 31 00 00 xx 00 yy BB CC	DD FF 00 07 C1 31 00 00 01 00 F6 BB CC	AB AB 00 07 C1 31 00 00 xx 00 yy CD CD
Screen On	DD FF 00 07 C1 31 00 00 xx 01 yy BB CC	DD FF 00 07 C1 31 00 00 01 01 F7 BB CC	AB AB 00 07 C1 31 00 00 xx 01 yy CD CD
Reboot	DD FF 00 06 C1 1E 00 00 xx yy BB CC	DD FF 00 06 C1 1E 00 00 01 D8 BB CC	AB AB 00 06 C1 1E 00 00 xx yy CD CD
Set AC Power On Mode	DD FF 00 07 C1 FF 00 09 xx zz yy BB CC	DDFF0007C1FF00090 10031BBCC zz: power on mode. 00 – direct, 01 – last, 02 – standby direct: DD FF 00 07 C1 FF 00 09 01 00 31 BB CC last: DD FF 00 07 C1 FF 00 09 01 01 30 BB CC standby: DD FF 00 07 C1 FF 00 09 01 02 33 BB CC	AB AB 00 07 C1 FF 00 09 xx zz yy CD CD
DP Input	DD FF 00 07 C1 08 00 00 xx 16 yy BB CC	DDFF0007C10800000116 D9BBCC	AB AB 00 07 C1 08 00 00 xx 16 yy CD CD
VGA Input	DD FF 00 07 C1 08 00 00 xx 17 yy BB CC	DDFF0007C10800000117 D8BBCC	AB AB 00 07 C1 08 00 00 xx 17 yy CD CD
HDMI1 Input	DD FF 00 07 C1 08 00 00 xx 0E yy BB CC	DDFF0007C1080000010 EC1BBCC	AB AB 00 07 C1 08 00 00 xx 0E yy CD CD
HDMI2 Input	DD FF 00 07 C1 08 00 00 xx 0F yy BB CC	DDFF0007C1080000010 FC0BBCC	AB AB 00 07 C1 08 00 00 xx 0F yy CD CD

PC Input	DD FF 00 07 C1 08 00 00 xx 0C yy BB CC	DFFF0007C1080000010 CC3BBCC	AB AB 00 07 C1 08 00 00 xx 0C yy CD CD
DVI Input	DD FF 00 07 C1 08 00 00 xx 09 yy BB CC	DFFF0007C1080000010 9C6BBCC	AB AB 00 07 C1 08 00 00 xx 09 yy CD CD
Set Screen Aspect Ratio	DD FF 00 07 C1 35 00 00 xx zz yy BB CC Once this command is set, reboot TV, it will show with expected ratio	ex: set screeep ratio 90 degrees DFFF0007C1350000010 9FBBBCC zz = 00 - 0 degree, 01 - 90 degree	AB AB 00 07 C1 35 00 00 xx zz yy CD CD
Set Mute	DD FF 00 07 C1 26 00 00 xx 01 yy BB CC	DFFF0007C1260000010 1E0BBCC	AB AB 00 07 C1 26 00 00 xx 01 yy CD CD
Set Unmute	DD FF 00 07 C1 26 00 00 xx 00 yy BB CC	DFFF0007C1260000010 0E1BBCC	AB AB 00 07 C1 26 00 00 xx 00 yy CD CD
Set Volume	DD FF 00 07 C1 27 00 00 xx zz yy BB CC	DFFF0007C1270000010 1E1BBCC zz: volume range 0-100	AB AB 00 07 C1 27 00 00 xx zz yy CD CD
Set Backlight Brightness	DD FF 00 08 C1 32 00 00 xx 06 zz yy BB CC	ex: set brightness to 32 - zz = 0x20 DFFF0008C1320000010 620DCBBCC	AB AB 00 08 C1 32 00 00 xx 06 zz CD CD
Set Backlight Brightness Auto Adjust	DD FF 00 07 C1 34 00 00 xx zz yy BB CC	ex: set brightness auto adust off DFFF0007C1340000010 0F3BBCC zz = 00 - off, 01 - on	AB AB 00 07 C1 34 00 00 xx zz yy CD CD
Set Date	DD FF 00 09 C1 1C 00 00 xx zz zz yy BB CC	ex: set date to 23.Jan.2 DFFF0009C11C0000011 7010 2C1BBCC zz zz zz = Year Month Day	AB AB 00 09 C1 1C 00 00 xx zz zz yy CD CD zz zz zz = FF FF FF when error
Set Time	DD FF 00 09 C1 1D 00 00 xx zz zz yy BB CC	ex: set time to 12:25:2 DFFF0009C11D0000010 C1902C3BBCC zz zz zz = Hour Minute Second	AB AB 00 09 C1 1D 00 00 xx zz zz yy CD CD zz zz zz = FF FF FF when error

Set Schedule for Power On	DD FF 00 09 C1 3E 00 00 xx tt zz zz yy BB CC	ex: power on at 9:10 every day DFFF0009C13E0000010 1090AF5BBCC tt = 00 - turn off schedule, 01 - everyday zz zz = Hour Minute Tips: If the device has been set to power on and off at a scheduled time, sending this command will clear the original settings, and leaving only the one sent.	AB AB 00 09 C1 3E 00 00 xx zz zz zz yy CD CD
Set Schedule for Power Off	DD FF 00 09 C1 3F 00 00 xx tt zz zz yy BB CC	ex: power off at 18:10 every day DFFF0009C13F0000010 1120AEFBCC tt = 0 - turn off schedule, 1 - everyday zz zz = Hour Minute Tips: If the device has been set with a timed power on/off command, all previously set power on/off will be turned off	AB AB 00 09 C1 3F 00 00 xx zz zz zz yy CD CD
Set Brightness	DD FF 00 07 C1 36 00 00 xx zz yy BB CC	ex: set brightness to 32 - zz = 0x20 DFFF0007C1360000012 0D1BBCC	AB AB 00 07 C1 36 00 00 xx zz yy CD CD
Set Contrast	DD FF 00 07 C1 37 00 00 xx zz yy BB CC current source must be: DP, VGA, HDMI, PC, DVI	ex: set contrast to 32 - zz = 0x20 DFFF0007C1370000012 0D0BBCC	AB AB 00 07 C1 37 00 00 xx zz yy CD CD
Set Sharpness	DD FF 00 07 C1 38 00 00 xx zz yy BB CC current source must be: DP, VGA, HDMI, PC, DVI	ex: set sharpness to 32 - zz = 0x20 DFFF0007C1380000012 0DFBCC	AB AB 00 07 C1 38 00 00 xx zz yy CD CD

Set Color Temperature	DD FF 00 07 C1 39 00 00 xx zz yy BB CC current source must be: DP, VGA, HDMI, PC, DVI	ex: set colour temperature to 32 - zz = 0x20 DDFF0007C1390000012 0DEBBCC	AB AB 00 07 C1 39 00 00 xx zz yy CD CD
Set Noise Reduction	DD FF 00 07 C1 3A 00 00 xx zz yy BB CC current source must be: DP, VGA, HDMI, PC, DVI	ex: set noise reduction to High - zz = 0x03 DDFF0007C13A0000010 3FEBBCC zz = 01 - low, 02 - medium, 03 - high, 04 - auto, 00 – off	AB AB 00 07 C1 3A 00 00 xx zz yy CD CD
Set Image Scaling	DD FF 00 07 C1 3B 00 00 xx zz yy BB CC current source must be: DP, VGA, HDMI, PC, DVI	ex: set image scaling to Full - zz = 0x03 DDFF0007C13B0000010 3FFBBCC zz = 00 - full, 01 - 16:9, 02 - 4:3, 03 - scaling 1, 04 - scaling 2, 05 - point to point	AB AB 00 07 C1 3B 00 00 xx zz yy CD CD
Set Picture Mode	DD FF 00 07 C1 0F 06 00 xx zz yy BB CC	ex: set picture mode to movie mode - zz = 0x03 DDFF0007C10F0600010 30CBBC zz = 00 - standard, 01 - bright, 02 - soft, 03 - Movie, 04 - Text, 5 - gaming 12 – natural	AB AB 00 07 C1 0F 06 00 xx zz yy CD CD
Set Sound Mode	DD FF 00 07 C1 FF 00 03 xx zz yy BB CC	ex: set sound mode to standard mode - zz = 0x00 DDFF0007C1FF0003010 03BBBCC zz = 00 - standard , 01 - music, 02 - news, 08 - movie, 10 - sports , 20 - custom, 30 - voice, 40 - meeting	AB AB 00 07 C1 FF 00 03 xx zz yy CD CD
Set Eye Protection Mode	DD FF 00 07 C1 FF 00 1E xx zz yy BB CC	ex: set eye protection mode on - zz = 0x01 DDFF0007C1FF001E010 127BBCC zz = 00 - off, 01 - on	AB AB 00 07 C1 FF 00 1E xx zz yy CD CD
VGA Auto Adjust	DD FF 00 07 C1 01 00 00 xx yy BB CC current source must be VGA	ex: VGA Auto Adjust DDFF0007C101000001C 6BBCC zz = 00 - off, 01 – on	AB AB 00 07 C1 01 00 00 xx yy CD CD

Set anti-burn-in (image retention)	DD FF 00 07 C1 33 00 00 xx zz yy BB CC	ex: set anti-burn-in on DDFF0007C1330000010 1F4BBCC zz = 00 - off, 01 - on	AB AB 00 07 C1 33 00 00 xx zz yy CD CD												
Set Power on delay	DD FF 00 07 C1 3C 00 00 xx zz yy BB CC	ex: set power on delay to 10s DDFF0007C13C0000010 AF1BBCC zz = 00 - off, others - delay time, range: 2s - 255s	AB AB 00 07 C1 3C 00 00 xx zz yy CD CD												
Set Video Wall	DD FF 00 09 C1 0A 00 00 xx zz zz zz yy BB CC	ex: vertical 3 devices, horizontal 4 devices, device position: 6 DDFF0009C10A0000010 30406C2BBCC zz: how many devices in vertical zz: how many devices in horizontal zz: current device position	AB AB 00 09 C1 0A 00 00 xx zz zz zz yy CD CD <table border="1" data-bbox="767 486 985 614"> <tr> <td>1</td> <td>2</td> <td>3</td> </tr> <tr> <td>4</td> <td>5</td> <td>6</td> </tr> <tr> <td>7</td> <td>8</td> <td>9</td> </tr> <tr> <td>10</td> <td>11</td> <td>12</td> </tr> </table>	1	2	3	4	5	6	7	8	9	10	11	12
1	2	3													
4	5	6													
7	8	9													
10	11	12													
Set Static IP Address of LAN	DD FF 00 16 C1 1B 30 00 xx zz ... zz yy BB CC	Ex: set IP 10.16.150.225, subnet mask: 255.255.248.0, gateway: 10.16.144.1, DNS: 10.16.144.2 DDFF0016C11B3000010 A1096E1FFFFFF8000A10 90010 A10900249BBCC zz .. zz - 16 bytes, IP address - 4 bytes, Subnet mask - 4 bytes, gateway - 4 bytes, DNS - 4 bytes	AB AB 00 16 C1 1B 30 00 xx zz ... zz yy CD CD												
Set USB Lock	DD FF 00 07 C1 FF 00 0E xx zz yy BB CC	ex: lock USB DDFF0007C1FF000E010 036BBCC zz = 00 - lock USB, 01 - enable USB	AB AB 00 07 C1 FF 00 0E xx zz yy CD CD												
Factory Reset	DD FF 00 06 C1 10 00 00 xx yy BB CC	DDFF0006C110000001D 6BBCC	AB AB 00 06 C1 10 00 00 xx yy CD CD												

Query TV Status	DD FF 00 06 C1 28 00 00 xx yy BB CC	DFFF0006C128000001E EBBCC	AB AB 00 0C C1 28 00 00 xx zz zz zz zz zz zz yy CD CD zz: volume zz zz: 05 01 - PC, 05 02 - DVI, 05 03 - DP, 05 04 - HDMI2, 05 05 - HDMI1, 08 01 - VGA zz: 00 - power on, FF - power off zz: 01 - mute; 00 - unmute zz: 00 - no signal, 01 - has signal
Query Screen Status	DD FF 00 06 C1 32 00 01 xx yy BB CC	DFFF0006C110000001D 6BBCC	AB AB 00 07 C1 32 00 01 xx zz yy CD CD zz: 00 - screen off; 01 - screen on
Query Source	DD FF 00 06 C1 1A 00 00 xx yy BB CC	DFFF0006C11A000001D CBBCC	AB AB 00 08 C1 1A 00 00 xx zz zz yy CD CD zz zz - source, refer to user menu for source definition
Query SW Version	DD FF 00 06 C1 1B 00 00 xx yy BB CC	DFFF0006C11B000001D DBBCC	AB AB 00 09 C1 1B 00 00 xx zz zz zz yy CD CD zz zz zz - Year Month Date
Query Backlight Brightness	DD FF 00 06 C1 3E 00 24 xx yy BB CC	DFFF0006C13E000001F 8BBCC	AB AB 00 LL C1 3E 00 24 xx zz zz yy CD CD zz:01 - bright , 02 - soft, 03 - auto adjust, 04 - stereo frequency conversion , 05 - Comfort frequency conversion , 06 - custom zz: when first zz is 06 custom, this byte means backlight brightness value: 0-30 LL: when first zz is zz, LL = 08, otherwise, LL = 07

Query Brightness	DD FF 00 06 C1 36 00 01 xx yy BB CC	DFFF0006C136000101F 0BBCC	AB AB 00 07 C1 36 00 01 xx zz yy CD CD zz is the brightness value
Query Network Status	DD FF 00 06 C1 FF 00 16 xx yy BB CC	DFFF0006C1FF0016012 FBBCC	AB AB 00 07 C1 FF 00 16 xx zz yy CD CD zz: 00 - no network connection; 01 - network connected
Query Sound Mode	DD FF 00 06 C1 FF 00 02 xx yy BB CC	DFFF0006C1FF0002013 BBBCC	AB AB 00 07 C1 FF 00 02 xx zz yy CD CD zz = 00 - standard , 01 - music, 02 - news, 08 - movie, 10 - sports , 20 - custom, 30 - voice, 40 - meeting
Query AC Power On Status	DD FF 00 06 C1 FF 00 08 xx yy BB CC	DFFF0006C1FF0008013 1BBCC	AB AB 00 07 C1 FF 00 08 xx zz yy CD CD zz: 00 - power on; 01 - Last mode; 02 - standby
Query IP Address	DD FF 00 06 C1 1B 20 00 xx yy BB CC	DFFF0006C11B200001F DBBCC	AB AB 00 16 C1 1B 20 00 xx zz ... zz yy CD CD zz zz zz zz - IP address zz zz zz zz - Subnet mask zz zz zz zz Gateway zz zz zz zz - DNS
Query Device Temperature	DD FF 00 06 C1 FE 00 00 xx yy BB CC	DFFF0006C1FE0000013 8BBCC	AB AB 00 07 C1 FE 00 00 xx zz yy CD CD zz: temperature in centigrade
Query Picture Mode	DD FF 00 06 C1 6D 00 00 xx yy BB CC	DD FF 00 06 C1 6D 00 00 64 CE BB CC	AB AB 00 07 C1 6D 00 00 xx zz yy CD CD zz: 00 – standard, 01 – bright, 06 – AI, 07 – user, 02 – soft, 03 – movie, 04 – text, 05 – game, 12- nature

Query USB Status	DD FF 00 06 C1 6E 00 00 xx yy BB CC	DD FF 00 06 C1 6E 00 00 64 CD BB CC	AB AB 00 07 C1 6E 00 00 xx zz yy CD CD zz: 00 - off, 01 - on
Query Eye Protection Mode	DD FF 00 06 C1 FF 00 1D xx yy BB CC	DFFF0006C1FF001D012 4BBCC	AB AB 00 07 C1 FF 00 1D xx zz yy CD CD zz: 00 - Off; 01 - On
Query SN	DD FF 00 06 C1 FF 00 0B xx yy BB CC	DFFF0006C1FF000B013 2BBCC	AB AB 00 1D C1 FF 00 0B xx zz...zz yy CD CD zz .. zz: 23 bytes serial number
Query Device ID	DD FF 00 06 C1 FF 00 0D xx yy BB CC	DFFF0006C1FF000D013 4BBCC	AB AB 00 26 C1 FF 00 0D xx zz...zz yy CD CD zz .. zz: 32 bytes device ID
Query MAC Address	DD FF 00 06 C1 6C 00 00 xx yy BB CC	DFFF0006C16C000001A ABBCC	AB AB 00 0C C1 6C 00 00 xx zz...zz yy CD CD zz .. zz: 6 bytes
Query volume	DD FF 00 06 C1 7D 00 00 xx yy BB CC	DD FF 00 06 C1 7D 00 00 64 DE BB CC	AB AB 00 07 C1 7D 00 00 xx zz yy CD CD zz: volume
Query Serial Port ID	DD FF 00 06 C1 1B 10 00 xx yy BB CC	DD FF 00 06 C1 1B 10 00 64 A8 BB CC	AB AB 00 06 C1 1B 10 00 xx zz yy CD CD zz: serial port ID. Settings -> signal manager -> serial port ID
Query brand	DD FF 00 06 C1 FE 00 01 xx yy BB CC	DD FF 00 06 C1 FE 00 01 64 5C BB CC	AB AB 00 06 C1 FE 00 01 xx zz...zz yy CD CD zz...zz: brand. ex: hisense (ASCII)
Query model	DD FF 00 06 C1 FE 00 02 xx yy BB CC	DD FF 00 06 C1 FE 00 02 64 5F BB CC	AB AB 00 06 C1 FE 00 02 xx zz...zz yy CD CD zz...zz: model name

Send Remote Controller Key Code	DD FF 00 08 C1 17 00 00 xx zz yy BB CC	ex: send menu key: zz zz = 00 00 DDFF0008C1170000010 000DFBBCC zz zz = 00 00 - Menu; 00 01 - UP, 00 02 - DOWN, 00 03 - LEFT, 00 04 - RIGHT , 00 05 - OK , 00 06 - Return, 00 07 - Source	AB AB 00 08 C1 17 00 00 xx zz yy CD CD
Open Settings	DD FF 00 06 C1 41 00 00 xx yy BB CC		AB AB 00 06 C1 41 00 00 xx yy CD CD
Open Home	DD FF 00 06 C1 FF 00 1A xx yy BB CC	DDFF0006C1FF001A 0123BBCC	AB AB 00 06 C1 FF 00 1A xx yy CD CD
Open CMS	DD FF 00 06 C1 FF 00 13 xx yy BB CC	DDFF0006C1FF0013012 ABBCC	AB AB 00 06 C1 FF 00 13 xx yy CD CD
Open ScreenShare	DD FF 00 06 C1 43 00 00 xx yy BB CC	DDFF0006C1430000018 5BBCC	AB AB 00 06 C1 43 00 00 xx yy CD CD
Turn on Hotspot	DD FF 00 06 C1 44 00 00 xx yy BB CC	DDFF0006C1440000018 2BBCC	AB AB 00 06 C1 44 00 00 xx yy CD CD
Take Screenshot	DD FF 00 06 C1 4B 00 00 xx yy BB CC	DDFF0006C14B0000018 DBCC	AB AB 00 06 C1 4B 00 00 xx yy CD CD
Freeze Screen	DD FF 00 07 C1 0F 08 00 xx zz yy BB CC	DD FF 00 07 C1 0F 08 00 01 01 C1 BB CC zz = 01 - freeze; 00 – unfreeze	AB AB 00 07 C1 0F 08 00 xx zz yy CD CD

[Note]

- The range of BoardID is from 01 to FF, supporting 255 machines to be networked together. 00 is the broadcast address, the commands issued by this ID will be executed by all MFPs, but the commands will not be returned.
- When all the commands received from TV terminal are returned to PC terminal, the start code should be changed to AB AB, and the end code should be changed to CD CD.
- Note for programming of control terminal: For power-on instruction, after power-on action is executed, it returns AB AB 00 08 C1 15 00 00 XX BB BB XX CD CD (refer to the above table for the meaning of XX); if the instruction is not received, it is necessary to send the power-on instruction again. after TV is turned on, the PC will receive AB AB 00 08 C1 15 00 00 00 XX BB BB XX CD CD again, and then the PC can send the control instruction. After the TV is switched on, the PC will receive the command again, then the PC can send control commands to the TV; if any command is not returned correctly, the interval between sending the command again should be more than 500ms.
- When TV is in sleep state, only power-on command and query command are supported.
- The functions of different models may vary, please refer to the actual model.

9

Miscellaneous

1 Troubleshooting

Before preparation for repair, please check the following table to see if the cause of problem you are encountering can be found.

If the problem still exists when you confirm that you are operating the product in strict accordance with the this manual, you can consider contacting professional service personnel for repair.

Symptom	Solution
No sound or image	<ul style="list-style-type: none"> • Check whether the power cord is connected to a wall outlet and whether the outlet is energized. • Check whether the power key is pressed. • Check the volume setting or whether it is muted.
Sound and image interference	<ul style="list-style-type: none"> • Try finding out the electrical appliance affecting the machine, and keep it away from the machine. • Try inserting the power plug of the machine to another power outlet.
Blurred or snowy screen, image distortion	<ul style="list-style-type: none"> • Check the position and connection of signal line.
Malfunction of remote control	<ul style="list-style-type: none"> • Replace the batteries in the remote control. • After removing the batteries, press any key several times, and then install new batteries. • Check the battery contacts. • Check whether any obstruction exists between the display screen and the remote control. • Check whether the anode and cathode of batteries are correctly installed.

2 Related Instructions

HDMI™ HDMI, HDMI High-Definition Multimedia Interface, and the HDMI Logo are trademarks or registered trademarks of HDMI Licensing Administrator, Inc. in the United States and other countries.

CRESTRON CONNECTED Crestron, the Crestron logo, Crestron Connected, and XiO Cloud are either trademarks or registered trademarks of Crestron Electronics, Inc. in the United States and/or other countries.

This product is built on the second-generation Crestron Connected® certified technology and is compatible with the Crestron XiO Cloud® Service. It integrates standardized communication interfaces to achieve seamless connectivity with the Crestron ecosystem, enabling cross-regional real-time monitoring and remote control. The system supports TLS end-to-end encrypted transmission, meeting centralized intelligent management requirements for commercial and smart home scenarios. Additionally, it provides dual-mode operation capabilities, combining local and cloud-based management functionalities.

[Statement]

- The pictures and descriptions in this manual are for reference only, please subject to our available products. (This statement is valid throughout this manual)
- Quality upgrade, product design and specification are subject to change without prior notice.
- The software content services applying to this product depend on the third-party provider. It is possible that partial software cannot be used due to network, region, service period or other problems, which has nothing to do with the product quality. Please contact the third-party provider for relevant details.

10 Specifications

Model		32DM66D/32DM66E	43DM66D/43DM66E	50DM66D/50DM66E
Product name		Digital Signage		
Size (mm) (W×H×D)	excluding handle	726.0×420.6×61.5	970.4×557.5×62.8	1124.1×644.2×62.5
	including handle	\	\	\
Product weight (kg)		4.6	8.5	11.0
Visual picture diagonal size (cm)		80	108	126
Display resolution		1920×1080	3840×2160	3840×2160
Product power		110W	130W	170W
Sound power		7W+7W	10W+10W	10W+10W
Model		55DM66D/55DM66E	65DM66D/65DM66E	75DM66D/75DM66E
Product name		Digital Signage		
Size (mm) (W×H×D)	excluding handle	1239.7×710.2×63.3	1458.9×832.8×63.7	1675.3×955.1×63.7
	including handle	\	\	1675.3×955.1×88.4
Product weight (kg)		13.9	21.5	29.0
Visual picture diagonal size (cm)		139	164	189
Display resolution		3840×2160	3840×2160	3840×2160
Product power		200W	240W	320W
Sound power		10W+10W	10W+10W	10W+10W

Model		86DM66D/86DM66E	100DM66D/100DM66E
Product name		Digital Signage	
Size (mm) (W×H×D)	excluding handle	1926.6×1095.5×64.2	2234.6×1285.6×86.5
	including handle	1926.6×1095.5×89.1	2234.6×1285.6×98.2
Product weight (kg)		38.2	59.0
Visual picture diagonal size (cm)		217	253
Display resolution		3840×2160	3840×2160
Product power		360W	450W
Sound power		10W+10W	15W+15W
Executive standard		Q/0202RSR 615	
Power supply		100-240V ~ 50/60Hz	
Environmental conditions		Operating temperature: 0°C~40°C Operating humidity: 10%~80%RH Atmospheric pressure: 86kPa~106kPa	

THIS PRODUCT IS LICENSED UNDER THE AVC PATENT PORTFOLIO LICENSE FOR THE PERSONAL USE OF A CONSUMER OR OTHER USES IN WHICH IT DOES NOT RECEIVE REMUNERATION TO (i) ENCODE VIDEO IN COMPLIANCE WITH THE AVC STANDARD (“AVC VIDEO”) AND/OR (ii) DECODE AVC VIDEO THAT WAS ENCODED BY A CONSUMER ENGAGED IN A PERSONAL ACTIVITY AND/OR WAS OBTAINED FROM A VIDEO PROVIDER LICENSED TO PROVIDE AVC VIDEO. NO LICENSE IS GRANTED OR SHALL BE IMPLIED FOR ANY OTHER USE. ADDITIONAL INFORMATION MAY BE OBTAINED FROM MPEG LA, L.L.C. SEE [HTTP://WWW.MPEGLA.COM](http://WWW.MPEGLA.COM)

Signal Formats Supported by DP Port

RGB/60Hz	640×480、800×600、1024×768、1280×720、1280×1024、1360×768、1366×768、1600×900、1920×1080、3840×2160
YUV/50Hz	720p、1080i、1080p
YUV/60Hz	720p、1080i、1080p

Signal Formats Supported by HDMI Port

RGB/60Hz	640×480、800×600、1024×768、1280×720、1280×1024、1360×768、1366×768、1440×900、1600×900、1920×1080、3840×2160
YUV/50Hz	576i、576p、720p、1080i、1080p
YUV/60Hz	480i、480p、720p、1080i、1080p

Multimedia Formats Supported by USB Port

Video coding format	VP9 / HEVC / H265 / MPEG1 / MPEG2 / MPEG4 / SorensomH.263 / H263 / H264 / AVS
Audio coding format	MP3 / AVI / ASF / MKA / MKV / 3gpp / 3gp / mp4 / m4a / flv / wav / ts / mpg / mpeg
Picture format	JPEG,BMP,PNG (The limitation of max resolution depends on DRAM size , up to 15360x8640)

Ovaj dokument je originalno proizveden i objavljen od strane proizvođača, brenda Hisense, i preuzet je sa njihove zvanične stranice. S obzirom na ovu činjenicu, Tehnoteka ističe da ne preuzima odgovornost za tačnost, celovitost ili pouzdanost informacija, podataka, mišljenja, saveta ili izjava sadržanih u ovom dokumentu.

Napominjemo da Tehnoteka nema ovlašćenje da izvrši bilo kakve izmene ili dopune na ovom dokumentu, stoga nismo odgovorni za eventualne greške, propuste ili netačnosti koje se mogu naći unutar njega. Tehnoteka ne odgovara za štetu nanесenu korisnicima pri upotrebi netačnih podataka. Ukoliko imate dodatna pitanja o proizvodu, ljubazno vas molimo da kontaktirate direktno proizvođača kako biste dobili sve detaljne informacije.

Za najnovije informacije o ceni, dostupnim akcijama i tehničkim karakteristikama proizvoda koji se pominje u ovom dokumentu, molimo posetite našu stranicu klikom na sledeći link:

<https://tehnoteka.rs/p/hisense-displej-43-digital-signage-43dm66d-akcija-cena/>