

Uputstvo za upotrebu

INDESIT električni šporet I6E5KMS



Tehnoteka je online destinacija za upoređivanje cena i karakteristika bele tehnike, potrošačke elektronike i IT uređaja kod trgovinskih lanaca i internet prodavnica u Srbiji. Naša stranica vam omogućava da istražite najnovije informacije, detaljne karakteristike i konkurentne cene proizvoda.

Posetite nas i uživajte u ekskluzivnom iskustvu pametne kupovine klikom na link:

<https://tehnoteka.rs/p/indesit-elektricni-sporet-i6e5kms-akcija-cena/>



Oven

User Manual

Pećnica

Korisnički priručnik



I6E5KMS

285380844_1/ EN/ BS/ R.AA/ 14.02.25 16:10
7734986488

Welcome!

Dear Customer,

Thank you for choosing the Indesit product. We want your product, manufactured with high quality and technology, to offer you the best efficiency. Therefore, carefully read this manual and any other documentation provided before using the product.

Keep in mind all the information and warnings stated in the user's manual. This way, you will protect yourself and your product against the dangers that may occur.

Keep the user's manual. If you give the product to someone else, give the manual with it.

The warranty conditions, usage and troubleshooting methods for your product are provided in this manual.

The symbols and their descriptions in the user's manual:



Hazard that may result in death or injury.



Important information or useful usage tips.



Read the user's manual.



Hot surface warning.

NOTICE Hazard that may result in material damage to the product or its environment.

Beko Europe Management Srl

Via Varesina 204, 20156 Milano, Italy

Table of Contents

1 Safety Instructions	4	7.2 Operation of the Oven Control Unit.....	24
1.1 Intended Use.....	4	8 General Information About Cooking	24
1.2 Child, Vulnerable Person and Pet Safety	4	8.1 General Information About Baking in the Oven	24
1.3 Electrical Safety	5	8.1.1 Pastries and oven food.....	25
1.4 Transportation Safety	7	8.1.2 Meat, Fish and Poultry	27
1.5 Installation Safety.....	7	8.1.3 Grill	27
1.6 Safety of Use	8	8.1.4 Test foods.....	28
1.7 Temperature Warnings	9	9 Maintenance and Cleaning	29
1.8 Accessory Use.....	9	9.1 General Cleaning Information.....	29
1.9 Cooking Safety	9	9.2 Cleaning Accessories.....	31
1.10 Maintenance and Cleaning Safety	11	9.3 Cleaning the hob.....	31
2 Environmental Instructions	11	9.4 Cleaning the Control Panel	31
2.1 Waste Directive.....	11	9.5 Cleaning the inside of the oven (cooking area).....	31
2.1.1 Compliance with the WEEE Directive and Disposing of the Waste Product	11	9.6 Easy Steam Cleaning	31
2.2 Package Information.....	12	9.7 Cleaning the Oven Door	32
2.3 Recommendations for Energy Saving.....	13	9.8 Removing the Inner Glass of The Oven Door	33
3 Your product	13	9.9 Cleaning the Oven Lamp.....	33
3.1 Product Introduction	13	10 Troubleshooting	34
3.1.1 Cooking unit	13		
3.1.2 Hob section	14		
3.2 Introduction of the oven control panel.....	14		
3.3 Oven operating functions.....	14		
3.4 Product Accessories	15		
3.5 Use of Product Accessories	16		
3.6 Technical Specifications.....	18		
4 Installation	19		
4.1 Right place for installation.....	19		
4.2 Electrical connection.....	20		
4.3 Placing the product	22		
5 First Use	22		
5.1 Initial Cleaning	22		
6 How to use the hob	22		
6.1 General information on hob usage.....	22		
6.2 Operation of the hobs	23		
7 Using the Oven	23		
7.1 General Information on Using the Oven	23		

1 Safety Instructions

- This section includes the safety instructions necessary to prevent the risk of personal injury or material damage.
- If the product is handed over to someone else for personal use or second-hand use purposes, the user's manual, product labels and other relevant documents and parts should also be given.
- Our company shall not be held responsible for damages that may occur if these instructions are not observed.
- Failure to follow these instructions shall void any warranty.
- Use original spare parts and accessories only.
- Do not repair or replace any component of the product unless it is clearly specified in the user's manual.
- Do not make technical modifications on the product.

1.1 Intended Use

- This product is designed to be used at home. It is not suitable for commercial use.
- Do not use the product in gardens, balconies or other outdoors. This product is intended to be used in households and

in the staff kitchens of shops, offices and other working environments.

- **CAUTION:** This product should be used for cooking purposes only. It should not be used for different purposes, such as heating the room.
- The oven can be used to defrost, bake, fry and grill food.
- This product should not be used for plate heating, drying by hanging towels or clothes on the handle.

1.2 Child, Vulnerable Person and Pet Safety

- This product can be used by children 8 years of age and older, and people who are underdeveloped in physical, sensory or mental skills, or who have lack of experience and knowledge, as long as they are supervised or trained about the safe use and hazards of the product.
- Children should not play with the product. Cleaning and user maintenance should not be performed by children unless there is someone overseeing them.
- This product should not be used by people with limited physical, sensory or mental ca-

capacity (including children), unless they are kept under supervision or receive the necessary instructions.

- Children should be supervised to ensure that they do not play with the product.
- Electrical products are dangerous for children and pets. Children and pets must not play with, climb on, or enter the product.
- Do not put objects that children may reach on the product.
- Turn the handle of the pots and pans to the side of the counter so that children cannot grab and burn.
- **CAUTION:** During use, the accessible surfaces of the product are hot. Keep children away from the product.
- Keep the packaging materials out of the reach of children. There is a hazard of injury and suffocation.
- When the door is open, do not put any heavy objects on it or allow children to sit on it. You may cause the oven to tip over or damage the door hinges.
- Before discarding worn out and useless products:
 1. Unplug the power plug and remove it from the socket.

2. Cut off the power cable and disconnect it with the plug from the product.
3. Take precautions to prevent children from entering the product.
4. Do not allow children to play with product when it is in idle mode.



1.3 Electrical Safety

- Plug the product into a grounded outlet protected by a fuse that matches the current ratings indicated on the type label. Have the grounding installation made by a qualified electrician. Do not use the product without grounding in accordance with local / national regulations.
- The plug or the electrical connection of the appliance shall be in an easily accessible place. If this is not possible, there should be a mechanism (fuse, switch, key switch, etc.) on the electrical installation to which the product is connected, in compliance with the electrical regulations and separating all poles from the network.
- Unplug the product or switch off the fuse before repair, maintenance and cleaning.

- Plug the product into an outlet that meets the voltage and frequency values specified on the type label.
 - (If your product does not have a mains cable) only use the connecting cable described in the "Technical specifications" section.
 - Do not jam the power cable under and behind the product. Do not put a heavy object on the power cable. The power cable should not be bent, crushed, and come into contact with any heat source.
 - Make sure that the power cable is not jammed while putting the product to its place after assembly or cleaning.
 - The rear surface of the oven gets hot when it is in use. The power cables must not touch the rear surface of the product. Otherwise it might get damaged.
 - Do not jam the electric cables into the oven door and do not pass them over hot surfaces. Otherwise, cable insulation may melt and cause fire as a result of short circuit.
 - Use original cable only. Do not use cut or damaged cables.
 - Do not use an extension cord or multi-plug to operate your product.
 - Contact the importer or the authorized service centre if the length of the power line is inadequate.
 - Portable power sources or multiple plugs may overheat and catch fire. Keep multiple plugs and portable power sources away from the product.
 - If the power cable is damaged, it must be replaced by the manufacturer, an authorized service or a person to be specified by the importer company in order to prevent possible dangers.
 - **CAUTION:** Before replacing the oven lamp, be sure to disconnect the product from the mains supply to avoid the risk of electric shock. Unplug the product or turn off the fuse from the fuse box.
- If your product has a power cable and plug:
- Never put the product plug into a broken, loose, or out-of-socket plug. Make sure the plug is fully inserted into the socket. Otherwise the connections may overheat and cause a fire.
 - Avoid inserting the device into plugs that are greasy, unclean, or potentially exposed to water (such as those near a worktop

where water may escape). Otherwise there is a risk of short circuit and electrocution.

- Never touch the plug with wet hands!
- Pull the plug out of the socket using the plug's body rather than the cord itself.

1.4 Transportation Safety

- Disconnect the product from the mains before transporting the product.
- The product is heavy, carry the product with at least two people.
- Do not use the door and / or handle to transport or move the product.
- Do not place items on the appliance. Carry the appliance vertically.
- When you need to transport the product, wrap it with bubble wrap packaging material or thick cardboard and tape it tightly. Secure the moving parts of the product firmly to prevent damage.
- Before the product is installed, check the product for any damage after transport. Contact the importer or the authorized service centre if damaged.

1.5 Installation Safety

- Before beginning the installation, de-energize the power line to which the product will be connected by turning off the fuse.
- Always wear protective gloves during transport and installation. Otherwise there is a risk of injury from sharp edges!
- Before the product is installed, check the product for any damage. Do not have it installed if the product is damaged.
- Never place the product on a carpet-covered floor. Product Otherwise, lack of airflow beneath the product will cause electrical parts to overheat. This will cause problems with your product.
- The product should be placed directly on a clean, flat and hard surface. It should not be placed on a plinth or bed plate. Products must not be placed on cardboard or plastic plates.
- Direct sunlight and heat sources, such as electric or gas heaters, must not be present in the area where the product is installed.
- Keep the surroundings of all ventilation ducts of the product open.

- Do not install the product near a window. There is a risk that the hob flame will ignite curtains and flammable materials around the hob. When you open the window, hot cookware may tip over.
- Do not install the product near a window. When you open the window, hot cookware may tip over.
- To avoid overheating, product installation should not be carried out behind decorative covers.
- In cases where a gas hose/ pipe or plastic water pipe is situated behind the designated installation area for the product, it is imperative to guarantee that there is no contact between the product and these utility lines. Otherwise the hose/pipe may be crushed.
- If there is a socket behind the place where the product will be installed, it must be ensured that the product does not come into contact with the socket nor with the plug plugged into the socket.
- There should be no gas hose, plastic water pipe and socket on the back or side wall of the place where the product will be installed. Otherwise, they may

be deformed by the heat effect when the hob is operated and may create a safety risk.

1.6 Safety of Use

- Ensure that the appliance is switched off after every use.
- If you will not use the product for a long time, unplug it or turn off the power from the fuse box.
- Don't use the product if it breaks down or gets damaged while being used. Disconnect the product from the electricity. Contact the importer or the authorized service centre.
- Do not use the product if the front door glass is removed or cracked. Otherwise there is a risk of injury and environmental damage.
- Do not step on the appliance for any reason.
- Never use the product when your judgement or coordination is impaired by the use of alcohol and/or drugs.
- Flammable objects must not be kept in and around the cooking area. Otherwise, these may lead to fire.
- The oven handle is not a towel dryer. When using the product, do not hang towels, gloves or similar textiles on the handle.

- The hinges of the product door move when opening and closing the door and might jam. When opening / closing the door, do not hold the part with the hinges.
- This product is not suitable for use with a remote control or an external clock.

1.7 Temperature Warnings

- **CAUTION:** When the product is in use, the product and its accessible parts will be hot. Care should be taken to avoid touching the product and heating elements. Children under 8 years of age should be kept away from the product unless constantly supervised.
- Do not place flammable / explosive materials near the product, as the surfaces will be hot while it is operating.
- Keep your distance when opening the oven door during or at the end of cooking. The steam may burn your hand, face and/or eyes.
- During operation the product is hot. Care should be taken to avoid touching hot parts, inside of the oven and heating elements.

1.8 Accessory Use

- It is important that the wire grill and tray are placed properly on the wire shelves. For detailed information, refer to the section "**Usage of accessories**".
- Close the oven door after pushing the accessories completely into the cooking space, otherwise they may hit the door glass and damage it.
- **CAUTION:** Use only hob guards designed by the manufacturer of the cooking appliance or indicated by the manufacturer of the appliance in the instructions for use as suitable or hob guards incorporated in the appliance. The use of inappropriate guards can cause accidents.

1.9 Cooking Safety

- **CAUTION:** The cooking process must be observed. Short-term cooking processes must be constantly observed.

- **CAUTION:** In solid or liquid oil cooking, it is dangerous to leave the hob unattended, which may cause a fire. NEVER try to extinguish the fire with water; disconnect the product from the mains, and then cover the flames with a cover or fire cloth (etc.).
 - Be careful when using alcoholic drinks in your dishes. Alcohol evaporates at high temperatures and may cause fire since it can ignite when it comes into contact with hot surfaces.
 - Food residues in the cooking area., such as oil, can ignite. Clean these residues before cooking.
 - Food Poisoning Hazard: Do not let food sit in oven for more than 1 hour before or after cooking. Otherwise it may cause food poisoning or diseases.
 - Do not heat closed tins and glass jars in the oven. The pressure that would build-up in the tin/jar may cause it to burst.
 - Do not place baking trays, dishes or aluminium foil directly onto the bottom of the oven. The accumulated heat might damage the bottom of the oven.
- Be mindful of the following precautions when using greasy parchment paper or similar materials:
- Place the greaseproof paper in a cookware or on the oven accessory (tray, wire grill, etc.) with food and place it in the preheated oven.
 - To prevent the risk of touching the oven heating elements and obstructing the flow of hot air, remove any excess parts of greaseproof paper that hang from accessories or containers. Do not use greaseproof paper at oven temperatures higher than the maximum usage temperature specified by the manufacturer. Never place greaseproof paper on the oven base.
 - Do not place it on top of accessories during preheating.
 - Always press down with a plate or similar object to prevent the material from flying around due to the air circulation inside the oven.
 - Only cover the necessary surface inside the tray.
 - After each use, the tray should be cleaned, and any greaseproof paper or similar materials used in the tray should be replaced. Otherwise,

liquids dripping onto the tray can cause smoking or even ignite flames.

- An air flow is generated when the product lid is opened. Greaseproof paper can come into contact with heating elements and ignite.
- When using a grilling rack for frying, a tray should be placed on the lower rack. Otherwise, the food oil and other components that drip onto the oven bottom can create heavy smoke and lead to flames.
- Close the oven door during grilling. Hot surfaces may cause burns!
- Food not suitable for grilling carries a fire hazard. Grill only food that is suitable for heavy grill fire. Do not place the food

too far in the back of the grill. This is the hottest area and fatty foods may catch fire.



1.10 Maintenance and Cleaning Safety

- Wait for the product to cool before cleaning the product. Hot surfaces may cause burns!
- Never wash the product by spraying or pouring water on it! There is the risk of electric shock!
- Do not use steam cleaners to clean the product as this may cause an electric shock.
- Do not use harsh abrasive cleaners, metal scrapers, scouring pads, dish washing wire or bleach to clean the oven front door glass and oven top door glass (if equipped). These materials can cause glass surfaces to be scratched and broken.

2 Environmental Instructions

2.1 Waste Directive

2.1.1 Compliance with the WEEE Directive and Disposing of the Waste Product

This product complies with EU WEEE Directive (2012/19/EU). This product bears a classification symbol for waste electrical and electronic equipment (WEEE).



This product has been manufactured with high quality parts and materials which can be re-used and are suitable for recycling. Therefore, do not dispose of the waste product with normal domestic and other wastes at the end of its service life. Take it to a collection point for the recycling of electrical and electronic equipment. You can ask your local administration about these collection points. Disposing of the appliance properly helps prevent negative consequences for the environment and human health.

Compliance with RoHS Directive:

The product you have purchased complies with EU RoHS Directive (2011/65/EU). It does not contain harmful and prohibited materials specified in the Directive.

DISPOSAL OF PACKAGING MATERIALS

The packaging material is 100% recyclable and is marked with the recycle symbol .

The various parts of the packaging must therefore be disposed of responsibly and in full compliance with local authority regulations governing waste disposal.

DISPOSAL OF HOUSEHOLD APPLIANCES

This appliance is manufactured with recyclable or reusable materials. Dispose of it in accordance with local waste disposal regulations. For further information on the treatment, recovery and recycling of household electrical appliances, contact your local authority, the collection service for household waste or the store where you purchased the appliance. This appliance is marked in compliance with European Directive 2012/19/EU, Waste Electrical and Electronic Equipment (WEEE) and with the Waste Electrical and Electronic Equipment regulations 2013 (as amended). By ensuring this product is disposed of correctly, you will help prevent negative consequences for the environment and human health. The  symbol on the product or on the accompanying documentation indicates that it should not be treated as domestic waste but must be taken to an appropriate collection center for the recycling of electrical and electronic equipment.

ENERGY SAVING TIPS

Only preheat the oven if specified in the cooking table or your recipe.

Use dark lacquered or enamelled baking trays as they absorb heat better.



Food requiring prolonged cooking will continue to cook even once the oven is switched off.

Make sure the oven door is closed completely when the appliance is turned on and keep it closed as much as possible while baking.

Cut the food into small, equally-sized pieces to reduce cooking time and save energy.

When the cooking time is long, over 30 minutes, reduce the oven temperature to the lowest setting during the last phase (3-10 minutes), based on the overall cooking time. The residual heat inside the oven will continue cooking the food.

DECLARATIONS OF CONFORMITY

This appliance meets: Ecodesign requirements of European Regulation 66/2014; Energy Labelling Regulation 65/2014; Ecodesign for Energy-Related Products and Energy Information (Amendment) (EU Exit) Regulations 2019, in compliance with the European standard EN 60350-1.

This appliance meets Ecodesign requirements of European Regulation 66/2014 and The Ecodesign for Energy-Related Products and Energy Information (Amendment) (EU Exit) Regulations 2019 in compliance with the European standard EN 60350-2.

This product can contain halogen light (Energy Efficiency Class G) or LED light source (Energy Efficiency Class F).

2.2 Package Information

Packaging materials of the product are manufactured from recyclable materials in accordance with our National Environment Regulations. Do not dispose of the packaging waste with the household or other wastes, take it to the packaging material collection points designated by the local authorities.

2.3 Recommendations for Energy Saving

According to EU 66/2014, information on energy efficiency can be found on the product receipt supplied with the product. The following suggestions will help you use your product in an ecological and energy-efficient way:

- Defrost frozen food before baking.
- In the oven, use dark or enamelled containers that transmit heat better.
- If specified in the recipe or user's manual, always preheat. Do not open the oven door frequently during baking.
- Turn off the product 5 to 10 minutes before the end time of baking in prolonged bakings. You can save up to 20% electricity by using residual heat.

- Try to cook more than one dish at a time in the oven. You may cook at the same time by placing two cookers on the wire rack. In addition, if you cook your meals one after the other, it will save energy because the oven will not lose its heat.
- Use pots / pans with a size and lid suitable for the hob zone. Always choose the right size pot for your meals. More than necessary energy is needed for containers of the wrong size.
- Keep hob baking areas and pot bases clean. Dirt reduces the heat transfer between the baking area and the pot base.

3 Your product

In this section, you can find the overview and basic uses of the product's control panel. There may be differences in images and some features depending on the type of product.

3.1 Product Introduction

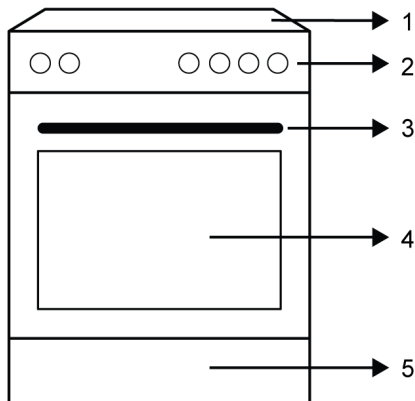

- 1 Hob section
- 2 Control panel
- 3 Handle
- 4 Door
- 5 Bottom part

3.1.1 Cooking unit

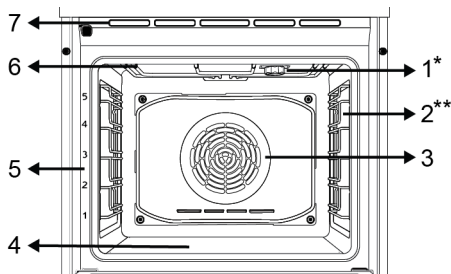

- 1 Lamp
- 2 Wire shelves
- 3 Fan motor (behind the steel plate)
- 4 Lower heater (under the steel plate)
- 5 Shelf positions
- 6 Upper heater
- 7 Ventilation holes

* Varies depending on the model. Your product may not be equipped with a lamp, or the type and location of the lamp may differ from the illustration.

** Varies depending on the model. Your product may not be equipped with a wire rack. In the image, a product with wire rack is shown as an example.

3.1.2 Hob section

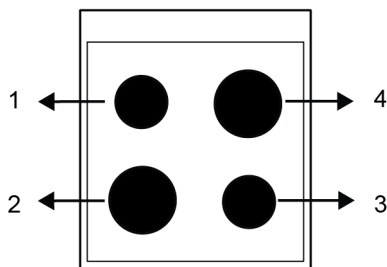

- 1 Rear left - Hotplate
- 2 Front left - Hotplate
- 3 Front right - Hotplate
- 4 Rear right - Hotplate

3.2 Introduction of the oven control panel

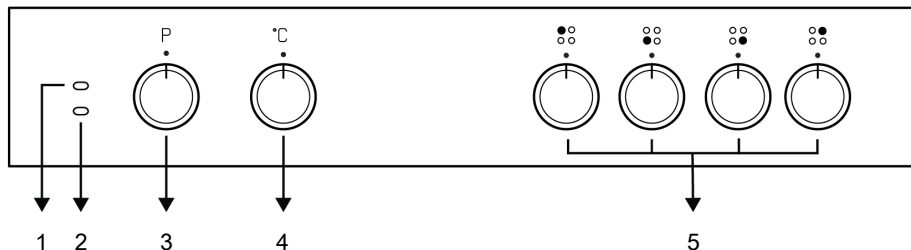

- 1 Active hob warning lamp
- 2 Thermostat lamp
- 3 Function selection knob
- 4 Temperature knob
- 5 Hob control knobs

If there are knob(s) controlling your product, in some models this/these knob(s) may be so that they come out when pushed (buried knobs). For settings to be made with these knobs, first push the relevant knob in and pull out the knob. After making your adjustment, push it in again and replace the knob.

Function selection knob

You can select the oven operating functions with the function selection knob. Turn left / right from closed (top) position to select.

Temperature knob

You can select the temperature you want to cook with the temperature knob. Turn clockwise from the closed (top) position to select.

Oven inner temperature indicator

You can understand the oven interior temperature from the temperature lamp. The thermostat lamp is located on the control







panel. The thermostat lamp turns on when the product starts to operate, and the thermostat lamp turns off when it reaches the set temperature. When the temperature inside the oven drops below the set temperature, the thermostat lamp turns on again.

Hob control knobs

You can operate your hob with the hob control knobs. Each knob operates the respective hotplate. You may infer which hotplate it controls from the symbols on the control panel.

3.3 Oven operating functions

On the function table, the operating functions you can use in your oven and the highest and lowest temperatures that can be set for these functions are shown. The order of the operating modes shown here may differ from the arrangement on your product.

Function symbol	Function description	Temperature range (°C)	Description and use
	Top and bottom heating	*	Food is heated from above and below at the same time. Suitable for cakes, pastries or cakes and stews in baking moulds. Cooking is done with a single tray.
	Bottom heating	*	Only lower heating is on. It is suitable for foods that need browning on the bottom. This function should also be used for easy steam cleaning.
	Fan assisted bottom/top heating	*	The hot air heated by the upper and lower heaters is distributed equally and rapidly throughout the oven with the fan. Cooking is done with a single tray.
	Full grill	*	The large grill on the oven ceiling works. It is suitable for grilling in large amounts.
	Fan assisted low grill	*	The hot air heated by the small grill is quickly distributed into the oven with the fan. It is suitable for grilling smaller amounts.
	Booster	-	All the heaters of the oven work. This operating function is used to quickly bring the oven to the desired temperature (pre-heating). Do not use it for cooking food.

* Your product operates in the temperature range specified on the temperature knob.

3.4 Product Accessories

There are various accessories in your product. In this section, the description of the accessories and the descriptions of the correct usage are available. Depending on the product model, the supplied accessory varies. All accessories described in the user's manual may not be available in your product.



The trays inside your appliance may be deformed with the effect of the heat. This has no effect on the functionality. Deformation disappears when the tray is cooled.

Standard tray

It is used for pastries, frozen foods and frying large pieces.

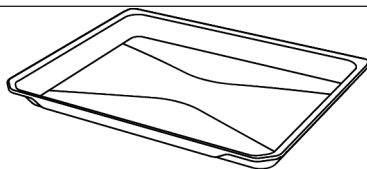

Wire grill

It is used for frying or placing the food to be baked, fried and stewed on the desired shelf.

On models with wire shelves :

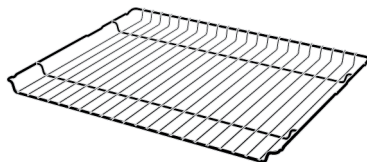

On models without wire shelves :

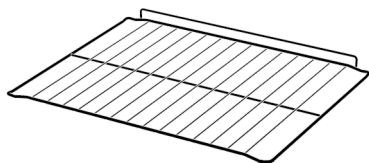

3.5 Use of Product Accessories

Cooking shelves

There are 5 levels of shelf position in the cooking area. You can also see the order of the shelves in the numbers on the front frame of the oven.

On models with wire shelves :

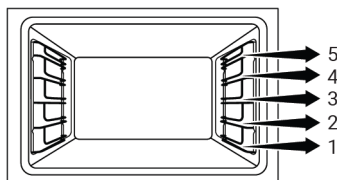

On models without wire shelves :

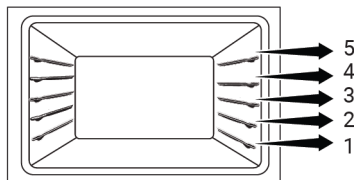

Placing the wire grill on the cooking shelves

On models with wire shelves :

It is crucial to place the wire grill on the wire side shelves properly. While placing the wire grill on the desired shelf, the open section must be on the front. For better cooking, the wire grill must be secured on the wire shelf's stopping point. It must not pass over the stopping point to contact with the rear wall of the oven.

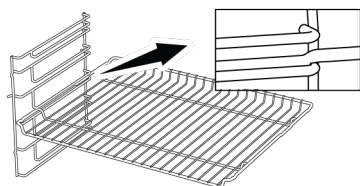

On models without wire shelves :

It is crucial to place the wire grill on the side shelves properly. The wire grill has one direction when placing it on the shelf. While placing the wire grill on the desired shelf, the open section must be on the front.

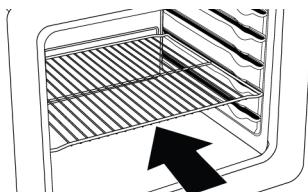

Placing the tray on the cooking shelves

On models with wire shelves :

It is also crucial to place the trays on the wire side shelves properly. While placing the tray on the desired shelf, its side designed for holding must be on the front. For better cooking, the tray must be secured on the stopping socket on the wire shelf. It must not pass over the stopping socket to contact with the rear wall of the oven.

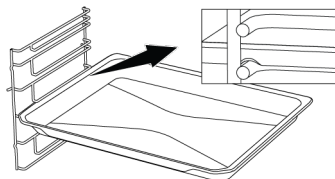

On models without wire shelves :

It is also crucial to place the trays on the side shelves properly. The tray has one direction when placing it on the shelf. While placing the tray on the desired shelf, its side designed for holding must be on the front.

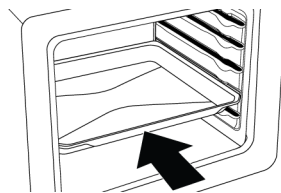

Stopping function of the wire grill

There is a stopping function to prevent the wire grill from tipping out of the wire shelf. With this function, you can easily and safely take out your food. While removing the wire

grill, you can pull it forward until it reaches the stopping point. You must pass over this point to remove it completely.

On models with wire shelves :

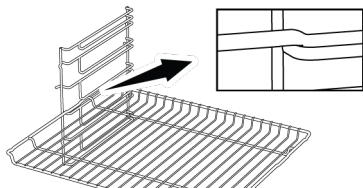

On models without wire shelves :

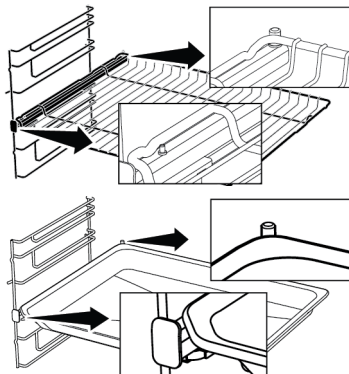
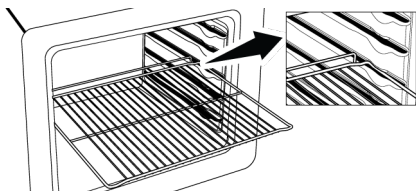

Tray stopping function - On models with wire shelves

There is also a stopping function to prevent the tray from tipping out of the wire shelf. While removing the tray, release it from the rear stopping socket and pull it towards yourself until it reaches the front side. You must pass over this stopping socket to remove it completely.

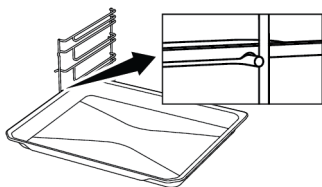

Proper placement of the wire grill and tray on the telescopic rails-On models with wire shelves and telescopic models

Thanks to the telescopic rails, trays or wire shelves can be easily installed and removed. Care should be taken to place the trays and wire shelves on the telescopic rails as shown in the figure below.

3.6 Technical Specifications

General specifications	
Product external dimensions (height/width/depth) (mm)	850 /600 /600
Voltage/Frequency	220-240 V ~ 50 Hz
Cable type and section used/suitable for use in the product	min. H05VV-FG 3 x 2,5 mm ² / 5 x 1,5 mm ²
Total power consumption (kW)	8,4
Oven type	Fan assisted oven
Front left	Hotplate
Dimension	180 mm
Power	2000 W
Rear left	Hotplate
Dimension	145 mm
Power	1000 W
Front right	Hotplate
Dimension	145 mm
Power	1000 W
Rear right	Hotplate
Dimension	180 mm
Power	2000 W

Basics: Information on the energy label of electrical ovens is given in accordance with the EN 60350-1 / IEC 60350-1 standard. Those values are determined under standard load with bottom-top heater or fan assisted heating (if any) functions.

Energy efficiency class is determined in accordance with the following prioritization depending on whether the relevant functions exist on the product or not: 1-Eco fan heating , 2-Fan Heating , 3-Fan assisted low grill , 4-Top and bottom heating.



Technical specifications may be changed without prior notice to improve the quality of the product.



Figures in this manual are schematic and may not exactly match your product.



Values stated on the product labels or in the documentation accompanying it are obtained in laboratory conditions in accordance with relevant standards. Depending on operational and environmental conditions of the product, these values may vary.

4 Installation

! General information

- Refer to the nearest Authorised Service Agent for installation of the product. Make sure that the electric and gas installations are in place before calling the Authorised Service Agent to have the product ready for operation. If not, call a qualified electrician and fitter to have the required arrangements made. The manufacturer shall not be held responsible for damages arising from procedures carried out by unauthorized persons which may also void the warranty.
- It is customer's responsibility to prepare the location the product shall be placed on and also have power and/or gas utility prepared.
- The rules specified in local standards about electrical and/or gas installations (legal rules on installation) shall be followed during product installation.
- Check for any damage on the appliance before the installation.

4.1 Right place for installation

- Place the product on a hard surface because of the air ducts under the product. It must not be placed onto a base or a pedestal. The feet of the product should not dip on soft surfaces, e.g. carpet, etc.
- The kitchen floor must be able to carry the weight of the appliance plus the additional weight of cookware and bakeware and food.
- This product is a class 1 device according to EN 30-1-1 standard. It can be placed adjacent to the kitchen walls, kitchen furniture or any other product in any dimension from behind and one edge. The kitchen furniture or equipment on the other side may only be of the same size or smaller.
- It can be used with cabinets on either side but in order to have a minimum distance of 400mm above hotplate level al-

low a side clearance of 65mm between the appliance and any wall, partition or tall cupboard.

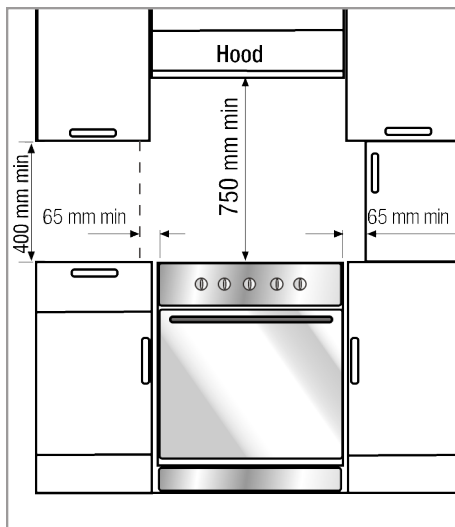

- It can also be used in a free standing position. Allow a minimum distance of 750 mm above the hob surface.
- If a cooker hood is to be installed above the cooker, refer to the instructions of the manufacturer of the cooker hood regarding installation height (min. 650 mm).
- Any kitchen furniture next to the appliance must be heat-resistant (100 °C min.).

Safety chain

The appliance must be secured against overbalancing by using the supplied one safety chain on your oven.

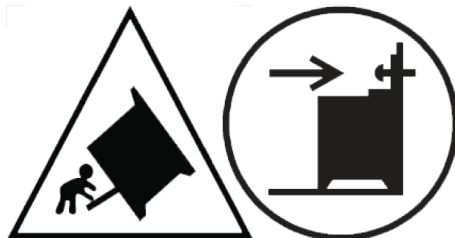

In order to prevent tipping of the appliance, this stabilizing means must be installed. Refer to the instructions for installation.

If your product has 2 safety chains;

Fasten hook (1) by using a proper peg to the kitchen wall (6) and connect safety chain (3) to the hook via the locking mechanism (2).

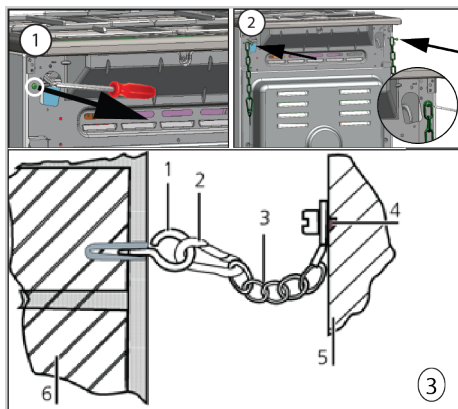

- 1 Hook
- 2 Locking mechanism
- 3 Safety chain
- 4 Firmly fix chain to product rear
- 5 Rear of product
- 6 Kitchen wall

If your product has 1 safety chains;

The appliance must be secured against overbalancing by using the supplied one safety chain on your oven.

Follow below steps in the picture to secure the safety chain to your product.

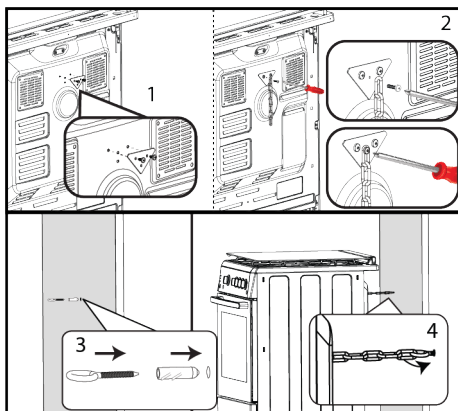

i Stability chain to be as short as practicable to avoid oven tilting forward and diagonal to avoid oven side tilting. Stability chain is designed for cookers without a bracket engagement slot.

4.2 Electrical connection

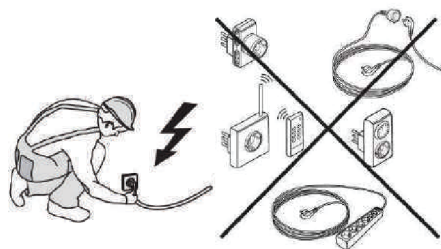
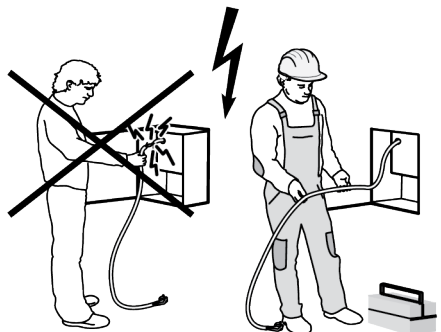

- Disconnect the product from the electric connection before starting any work on the electrical installation. There is an electric shock hazard.
- Connect the product to a grounded outlet/line protected by a miniature circuit breaker of suitable capacity as stated in the "Technical specifications" table. Have the grounding installation made by a qualified electrician while using the product with or without a transformer. Our company shall not be liable for any damages that will arise due to using the product without a grounding installation in accordance with the local regulations.
- The product can only be connected to the mains electricity connection by an authorized and qualified person, and the

warranty of the product starts only after correct installation. The manufacturer cannot be held responsible for any damages that may arise due to operations by unauthorized persons.

- The electric cable must not be crushed, folded, jammed or touch hot parts of the product. If the electric cable is damaged, it must be replaced by a qualified electrician. Otherwise there is an electric shock, short circuit or fire hazard!
- The mains supply data must correspond to the data specified on the type label of the product. The rating plate is either seen when the door or the lower cover of the appliance is opened or it is located at the rear wall of the appliance depending on the appliance type.
- and must use the appropriate socket outlet/line and plug for oven. In case of the product's power limits are out of current carrying capability of plug and socket outlet/line, the product must be connected through fixed electrical installation directly without using plug and socket outlet/line.
- **If the product will be connected directly to the supply power:** If it is not possible to disconnect all poles in the supply power, a disconnection unit with at least 3 mm contact clearance (fuses, line safety switches, contactors) must be connected and all the poles of this disconnection unit must be adjacent to (not above) the product in accordance with IEE directives. Failure to obey this instruction may cause operational problems and invalidate the product warranty.
- Additional protection by a residual current circuit breaker is recommended.

If the product is produced without cable:

- A power cable that it is defined in the technical table home must be connected to product by following the instructions. Power cable must not be longer than 2 m because of safety reasons.
- Open the terminal block cover with a screwdriver.

- Insert the power cable through the cable clamp below the terminal and secure it to the main body with the integrated screw on cable clamping component.
- Connect the cables according to the supplied diagram.

Make the terminal block connection of your product according to the connection/phase information on the product type label.

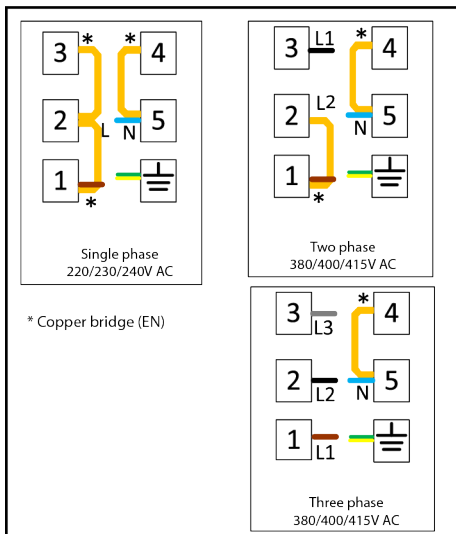

If your supply cord type is 3-conductor type, for 1-phase connection:

- Brown/Black = L (Phase)
- Blue = N (Neutral)
- Green/Yellow wire = (E)  (Earthing)

If your supply cord type is 5-conductor type, for 3-phase connection:

- Brown = L1 (Phase)
- Black = L2 (Phase)
- Grey = L3 (Phase)
- Blue = N (Neutral)
- Green/Yellow wire = (E)  (Earthing)
- After completing the wire connections, close the terminal block cover.
- Connect the power cable to supply power by routing it so that it will not contact the product and get squeezed between the product and the wall.

4.3 Placing the product

1. Push the product towards the kitchen wall.
2. Secure the safety chain you have connected to the product to the wall.
3. Adjust the feet of oven

Adjusting the feet of oven

Vibrations during use may cause cooking vessels to move. This dangerous situation can be avoided if the product is level and balanced.

5 First Use

Before you start using your product, it is recommended to do the following stated in the following sections respectively.

5.1 Initial Cleaning

1. Remove all packaging materials.
2. Remove all accessories from the oven provided with the product.
3. Operate the product for 30 minutes and then, turn it off. This way, residues and layers that may have remained in the oven during production are burned and cleaned.
4. When operating the product, select the highest temperature and the operating function that all the heaters in your

product operate. See "Oven operating functions". You can learn how to operate the oven in the following section.

Final check

1. Reconnect the product to the mains.
2. Check electrical functions.

product operate. See "Oven operating functions". You can learn how to operate the oven in the following section.

5. Wait for the oven to cool.
6. Wipe the surfaces of the product with a wet cloth or sponge and dry with a cloth.

Before using the accessories:

Clean the accessories you remove from the oven with detergent water and a soft cleaning sponge.

NOTICE: During the first use, smoke and odour may come up for several hours. This is normal and you just need good ventilation to remove it. Avoid directly inhaling the smoke and odours that form.

6 How to use the hob

6.1 General information on hob usage

- Refrain from using unbalanced and easily tilting pots/pans on the hob.

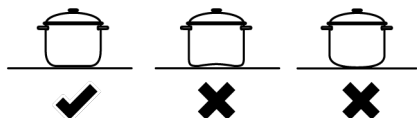

- Refrain from heating the pots/pans and pots empty. The pots and the appliance may be damaged.
- Always turn off the hob's burners after each use.

- You shall damage the appliance if you operate the hobs without any pot or pots/pans. Always turn off the hobs after each operation.
- Put a sufficient amount of food in pots and pans. Thus, you can prevent food from pouring forth out of the pots/pans and will not need to clean unnecessarily.
- Refrain from placing the covers of pots and pans on burners/zones.
- Place the pots by centering them on the burners/zones. If you wish to place a pot on a different burner/zone, do not slide it towards the desired burner; rather, lift it first and then put it on the other burner.

Recommended cooking pots/pans sizes

Cooking zone diameter - mm	Pot diameter - cm
80	8 – 10
145	14 – 16
180	18 - 20
220	22 - 24

6.2 Operation of the hobs

Using the hotplate(s)

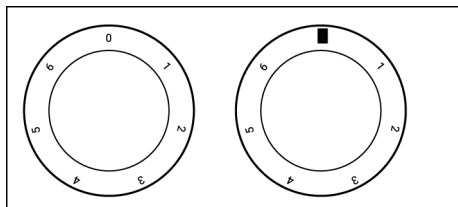

You may operate the hotplate(s) with hob control knob(s). Each knob operates the respective hotplate. You may infer which hotplate it controls from the symbols on the control panel.

When turned off (top position), the hotplate does not operate. Set your desired cooking level by aligning the knob to the respective levels.

The hob(s) may have different operating levels as per the model of your appliance. You may select the relevant level for your cooking type by referring to the table below.

6 levels:

- 1 : Heating
- 2 – 3 : Boiling, Resting
- 4 – 6 : Baking, Frying, Boiling

7 Using the Oven

7.1 General Information on Using the Oven

Cooling fan (It varies depending on the product model. It may not be available on your product.)

Your product has a cooling fan. The cooling fan is activated automatically when necessary and cools both the front of the product

Active hob warning lamp

As soon as the hotplate(s) are turned on, the active hob warning lamp on the control panel turns on. This lamp indicates that the hotplate or at least one of its hotplates, if any, is working. When all the knobs on the hotplate(s) are turned off, the lamp goes off.

Turning the hotplate on

To operate the hotplates, the hob control knobs are used. To obtain your desired cooking level, switch the hob control knob to the desired level.

Turning the hotplate off

Bring the hob control knob to OFF position (top).



If there are hotplates with quick heating feature, these are marked with a red dot.

Overheating protection

Hobs with a power above 1000 W are equipped with overheating protection. Overheating protection reduces the power of the hotplate in the following conditions:

- No pots or vessels on the hotplate.
- Empty pot or vessel on the hotplate.
- The fact that the base of the pot or vessel is not flat.

and the furniture. It is automatically deactivated when the cooling process is finished. Hot air comes out over the oven door. Refrain from covering these ventilation openings. Otherwise, the oven may overheat. The cooling fan continues to operate during oven operation or after the oven is turned off (approximately 20-30 minutes). If you cook by programming the

oven timer, at the end of the baking time, the cooling fan turns off with all functions. The cooling fan running time cannot be determined by the user. It turns on and off automatically. This is not an error.

Oven lighting

The oven lighting is turned on when the oven starts baking. In some models, the lighting is on during baking, while in some models it turns off after a certain time.

7.2 Operation of the Oven Control Unit

Turning on the oven

When you select a operating function you want to cook with the function selection knob and set a certain temperature with the temperature knob, the oven starts operating.

Turning off the oven

You can turn the oven off by turning the function selection knob and temperature knob to the off (up) position.

Selecting the temperature and oven operating function.

You can cook by making a manual control (at your own control) by selecting the temperature and operating function specific to your food.

8 General Information About Cooking

You can find tips on preparing and cooking your food in this section.

Plus, this section describes some of the foods tested as producers and the most appropriate settings for these foods. Appropriate oven settings and accessories for these foods are also indicated.

8.1 General Information About Baking in the Oven

- While opening the oven door during or after baking, hot-burning steam may emerge. The steam may burn your hand, face and/or eyes. When opening the oven door, stay away.



1. Select the operating function you want to cook with the function selection knob.
2. Set the temperature you want to cook with the temperature knob.
 - ⇒ Your oven will start operating immediately at the selected function and temperature, and the thermostat lamp will turn on. When the temperature inside the oven reaches the desired temperature, the thermostat lamp will turn off. The oven will not turn off by itself after the baking process. You have to control baking and turn it off yourself. When your baking is completed, turn off the oven by turning the function selection knob and the temperature knob to the off (up) position.

- Intense steam generated during baking may form condensed water drops on the interior and exterior of the oven and on the upper parts of the furniture due to the temperature difference. This is a normal and physical occurrence.
- Condensation or water vapour may appear as sweating or dripping on the oven's inner glass, depending on the food. This common occurrence could happen when cooking. It is advised to use a moist cloth to wipe the inner glass clean when the product has cooled down after cooking.

- The cooking temperature and time values given for foods may vary depending on the recipe and amount. For this reason, these values are given as ranges.
- Always remove unused accessories from the oven before you start cooking. Accessories that will remain in the oven may prevent your food from being cooked at the correct values.
- For foods that you will cook according to your own recipe, you can reference similar foods given in the cooking tables.
- Using the supplied accessories ensures you get the best cooking performance. Always observe the information provided by the manufacturer for the external cookware you will use.
- Cut the greaseproof paper you will use in your cooking in suitable sizes to the container you will cook. Greaseproof papers that are overflowing from the container can create a risk of burns and affect the quality of your baking. Use the greaseproof paper you will use in the temperature range specified.
- For good baking performance, place your food on the recommended correct shelf. Do not change the shelf position during baking.
- Metal, ceramic and glass moulds extend the cooking time and the bottom surfaces of pastry foods do not brown evenly.
- If you are using baking paper, a small browning can be observed on the bottom surface of the food. In this situation, you may have to extend your cooking period by approximately 10 minutes.
- The values specified in the cooking tables are determined as a result of the tests carried out in our laboratories. Values suitable for you may differ from these values.
- Place your food on the appropriate shelf recommended in the cooking table. Refer to the bottom shelf of the oven as shelf 1.
- Cook the recommended dishes in the cooking table with a single tray.

Tips for baking cakes

- If the cake is too dry, increase the temperature by 10°C and shorten the baking time.
- If the cake is moist, use a small amount of liquid or reduce the temperature by 10°C.
- If the top of the cake is burnt, put it on the lower shelf, lower the temperature and increase the baking time.
- If the inside of the cake is cooked well, but outside is sticky, use less liquid, decrease the temperature and increase the cooking time.

Hints for pastry

- If the pastry is too dry, increase the temperature by 10 °C and shorten the cooking time. Wet the dough sheets with a sauce consisting of milk, oil, egg and yoghurt mixture.
- If the pastry is getting cooked slowly, make sure that the thickness of the pastry you have prepared does not overflow the tray.
- If the pastry is browned on the surface but the bottom is not cooked, make sure that the amount of sauce you will use for the pastry is not too much at the bottom

8.1.1 Pastries and oven food

General Information

- We recommend using the accessories of the product for a good cooking performance. If you will use an external cookware, prefer dark, non-sticking and heat resistant ware.
- If preheating is recommended in the cooking table, be sure to put your food in the oven after preheating.
- If you will cook by using cookware on the wire grill, place it in the middle of the wire grill, not near the back wall.
- All materials used in making pastry should be fresh and at room temperature.
- The cooking status of the foods may vary depending on the amount of food and the size of the cookware.

of the pastry. For an even browning, try to spread the sauce evenly between the dough sheets and the pastry.

- Bake your pastry in the position and temperature appropriate to the cooking table. If the bottom is still not browned enough, place it on a bottom shelf for the next cooking.

Cooking table for pastries and oven foods

Food	Accessory to be used	Operating function	Shelf position	Temperature (°C)	Baking time (min) (approx.)
Cake on the tray	Standard tray *	Top and bottom heating	3	180	30 ... 45
Cake in the mould	Cake mould on wire grill** **	Top and bottom heating	2	180	30 ... 50
Small cakes	Standard tray *	Top and bottom heating	3	160	25 ... 35
Small cakes	Standard tray *	Fan assisted bottom/top heating	2	150	20 ... 30
Sponge cake	Round springform pan, 26 cm in diameter on wire grill **	Top and bottom heating	2	160	30 ... 45
Sponge cake	Round springform pan, 26 cm in diameter on wire grill **	Fan assisted bottom/top heating	2	160	20 ... 30
Cookie	Pastry tray *	Top and bottom heating	3	170	25 ... 40
Rich pastry	Standard tray *	Fan assisted bottom/top heating	2	200	30 ... 40
Dough pastry	Standard tray *	Top and bottom heating	2	200	20 ... 35
Whole bread	Standard tray *	Top and bottom heating	3	200	30 ... 45
Lasagne	Glass / metal rectangular container on wire grill **	Top and bottom heating	2 or 3	200	30 ... 45
Apple pie	Round black metal mould, 20 cm in diameter on wire grill **	Top and bottom heating	2	180	60 ... 75
Pizza	Standard tray *	Top and bottom heating	2	220	10 ... 25

Preheating is recommended for all food.

*These accessories may not be included with your product.

**These accessories are not included with your product. They are commercially available accessories.

8.1.2 Meat, Fish and Poultry

The key points on grilling

- Seasoning it with lemon juice and pepper before cooking whole chicken, turkey and large pieces of meat will increase cooking performance.
- It takes 15 to 30 minutes more to cook boned meat than fillet by frying.
- You should calculate about 4 to 5 minutes of cooking time per centimetre of the meat thickness.

- After the cooking time is expired, keep the meat in the oven for approximately 10 minutes. The juice of the meat is better distributed to the fried meat and does not come out when the meat is cut.
- Fish should be placed on the medium or low level shelf in a heat resistant plate.
- Cook the recommended dishes in the cooking table with a single tray.

Cooking table for meat, fish and poultry

Food	Accessory to be used	Operating function	Shelf position	Temperature (°C)	Baking time (min) (approx.)
Steak (whole) / Roast (1 kg)	Standard tray *	Fan assisted bottom/top heating	3	15 mins. 250/ max, after 180 ... 190	60 ... 80
Lamb's shank (1,5-2 kg)	Standard tray *	Fan assisted bottom/top heating	3	15 mins. 250/ max, after 170	110 ... 120
Fried chicken (1,8-2 kg)	Wire grill * Place one tray on a lower shelf	Fan assisted bottom/top heating	2	15 mins. 250/ max, after 190	60 ... 80
Turkey (5.5 kg)	Standard tray *	Fan assisted bottom/top heating	1	25 mins. 250/ max, after 180 ... 190	150 ... 210
Fish	Wire grill * Place one tray on a lower shelf	Fan assisted bottom/top heating	3	200	20 ... 30

Preheating is recommended for all food.

*These accessories may not be included with your product.

**These accessories are not included with your product. They are commercially available accessories.

8.1.3 Grill

Red meat, fish and poultry meat quickly turns brown when grilled, holds a beautiful crust and does not dry out. Fillet meats, skewer meats, sausages as well as juicy vegetables (tomatoes, onions, etc.) are particularly suitable for grilling.

General information

- When the preheating time is 5 minutes in the grill mode, skip the preheating, do not wait for the entire preheating time to pass.
- **Close the oven door during grilling. Never grill with the oven door open.**

The key points of the grill

- Prepare foods of similar thickness and weight as much as possible for the grill.
- Place the pieces to be grilled on the wire grill or wire grill tray by distributing them without exceeding the dimensions of the heater.
- Depending on the thickness of the pieces to be grilled, the cooking times given in the table may vary.
- Slide the wire grill or the wire grill tray to the desired level in the oven. If you are cooking on the wire grill, slide the oven tray to the lower shelf to collect the oils. The oven tray you will slide should be sized to cover the entire grill area. This

tray may not be supplied with the product. Put some water into the oven tray for easy cleaning.

Grill table

Food	Accessory to be used	Shelf position	Temperature (°C)	Baking time (min) (approx.)
Fish	Wire grill	4 - 5	250	20 ... 25
Chicken pieces	Wire grill	4 - 5	250	25 ... 35
Meatball (veal) - 12 amount	Wire grill	4	250	20 ... 30
Lamb chop	Wire grill	4 - 5	250	20 ... 25
Steak - (meat cubes)	Wire grill	4 - 5	250	25 ... 30
Veal chop	Wire grill	4 - 5	250	25 ... 30
Vegetable gratin	Wire grill	4 - 5	220	20 ... 30
Toast bread	Wire grill	4	250	1 ... 4

It is recommended to preheat for 5 minutes for all grilled food.

Turn pieces of food after 1/2 of the total grilling time.

Fan assisted low grill

Food	Accessory to be used	Operating function	Shelf position	Temperature (°C)	Baking time (min) (approx.)
Fish	Wire grill	Fan assisted low grill	4	200	30 ... 35
Chicken pieces	Wire grill	Fan assisted low grill	4	250	25 ... 35
Meatball (veal) - 12 amount	Wire grill	Fan assisted low grill	4	250	30 ... 40
Steak (whole) / Roast (1 kg)	Wire grill - Place one tray on a lower shelf	Fan assisted low grill	3	15 mins. 250, after 180 ... 190	90 ... 110

Do not preheat the dishes recommended in this grill chart.

8.1.4 Test foods

- Foods in this cooking table are prepared according to the EN 60350-1 standard to facilitate testing of the product for control institutes.

- Cook the recommended dishes in the cooking table with a single tray.

Cooking table for test meals

Food	Accessory to be used	Operating function	Shelf position	Temperature (°C)	Baking time (min) (approx.)
Shortbread (sweet cookie)	Standard tray *	Top and bottom heating	3	140	20 ... 30
Small cakes	Standard tray *	Top and bottom heating	3	160	25 ... 35
Small cakes	Standard tray *	Fan assisted bottom/top heating	2	150	20 ... 30

Food	Accessory to be used	Operating function	Shelf position	Temperature (°C)	Baking time (min) (approx.)
Sponge cake	Round springform pan, 26 cm in diameter on wire grill **	Top and bottom heating	2	160	30 ... 45
Sponge cake	Round springform pan, 26 cm in diameter on wire grill **	Fan assisted bottom/top heating	2	160	20 ... 30
Apple pie	Round black metal mould, 20 cm in diameter on wire grill **	Top and bottom heating	2	180	60 ... 75

Preheating is recommended for all food.

*These accessories may not be included with your product.

**These accessories are not included with your product. They are commercially available accessories.

Grill

Food	Accessory to be used	Shelf position	Temperature (°C)	Baking time (min) (approx.)
Meatball (veal) - 12 amount	Wire grill	4	250	20 ... 30
Toast bread	Wire grill	4	250	1 ... 4

It is recommended to preheat for 5 minutes for all grilled food.
Turn pieces of food after 1/2 of the total grilling time.

9 Maintenance and Cleaning

9.1 General Cleaning Information

General warnings

- Wait for the product to cool before cleaning the product. Hot surfaces may cause burns!
- Do not apply the detergents directly on the hot surfaces. This may cause permanent stains.
- The product should be thoroughly cleaned and dried after each operation. Thus, food residues shall be easily cleaned and these residues shall be prevented from burning when the product is used again later. Thus, the service life of the appliance extends and frequently faced problems are decreased.
- Do not use steam cleaning products for cleaning.
- Some detergents or cleaning agents cause damage to the surface. Unsuitable cleaning agents are: bleach, cleaning products containing ammonia, acid or chloride, steam cleaning products, descaling agents, stain and rust removers, abrasive cleaning products (cream cleaners, scouring powder, scouring cream, abrasive and scratching scrubber, wire, sponges, cleaning cloths containing dirt and detergent residues).
- No special cleaning material is needed in the cleaning made after each use. Clean the appliance using dishwashing detergent, warm water and a soft cloth or sponge and dry it with a dry cloth.
- Be sure to completely wipe off any remaining liquid after cleaning and immediately clean any food splashing around during cooking.
- Do not wash any component of your appliance in a dishwasher unless otherwise stated in the user's manual.

For the hobs:

- Acidic dirt such as milk, tomato paste and oil may cause permanent stains on the hobs and components of the hob zones, clean any overflowed fluids immediately after cooling down the hob by turning it off.

Inox - stainless surfaces

- Do not use acid or chlorine-containing cleaning agents to clean stainless-inox surfaces and handles.
- Stainless-inox surface may change colour in time. This is normal. After each operation, clean with a detergent suitable for the stainless or inox surface.
- Clean with a soft soapy cloth and liquid (non-scratching) detergent suitable for inox surfaces, taking care to wipe in one direction.
- Remove lime, oil, starch, milk and protein stains on the glass and inox surfaces immediately without waiting. Stains may rust under long periods of time.
- Cleaners sprayed/applied to the surface should be cleaned immediately. Abrasive cleaners left on the surface cause the surface to turn white.

Enamelled surfaces

- The oven must cool down before cleaning the cooking area. Cleaning on hot surfaces shall create both fire hazard and damage the enamel surface.
- After each use, clean the enamel surfaces using dishwashing detergent, warm water and a soft cloth or sponge and dry them with a dry cloth.
- If your product has an easy steam cleaning function, you can make easy steam cleaning for light non-permanent dirt. (See "Easy Steam Cleaning [▶ 31]").

Catalytic surfaces

- The side walls in the cooking area can only be covered with enamel or catalytic walls. It varies by model.
- The catalytic walls have a light matte and porous surface. The catalytic walls of the oven should not be cleaned.

- Catalytic surfaces absorb oil thanks to its porous structure and start to shine when the surface is saturated with oil, in this case it is recommended to replace the parts.

Glass surfaces

- When cleaning glass surfaces, do not use hard metal scrapers and abrasive cleaning materials. They can damage the glass surface.
- Clean the appliance using dishwashing detergent, warm water and a microfiber cloth specific for glass surfaces and dry it with a dry microfiber cloth.
- If there is residual detergent after cleaning, wipe it with cold water and dry with a clean and dry microfiber cloth. Residual detergent may damage the glass surface next time.
- Under no circumstances should the dried-up residue on the glass surface be cleaned off with serrated knives, wire wool or similar scratching tools.
- You can remove the calcium stains (yellow stains) on the glass surface with the commercially available descaling agent, with a descaling agent such as vinegar or lemon juice.
- If the surface is heavily soiled, apply the cleaning agent on the stain with a sponge and wait a long time for it to work properly. Then clean the glass surface with a wet cloth.
- Discolorations and stains on the glass surface are normal and not defects.

Plastic parts and painted surfaces

- Clean plastic parts and painted surfaces using dishwashing detergent, warm water and a soft cloth or sponge and dry them with a dry cloth.
- Do not use hard metal scrapers and abrasive cleaners. They may damage the surfaces.
- Ensure that the joints of the components of the product are not left damp and with detergent. Otherwise, corrosion may occur on these joints.

9.2 Cleaning Accessories

Do not put the product accessories in a dishwasher unless otherwise stated in the user's manual.

9.3 Cleaning the hob

Electric hobs

1. Turn off the hotplates and wait until they cool down.
2. If necessary, clean the hotplates with a cleaning agent (you can obtain cleaners/softeners from specialty stores).
3. Warm only for a few minutes after cleaning in order to have their top section dried.
4. Apply a thin layer of machine oil onto the top surface of the hotplate regularly in order to protect it.

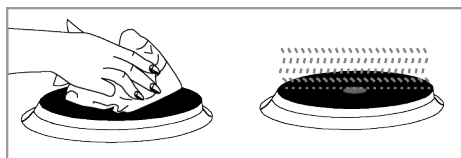

9.4 Cleaning the Control Panel

- When cleaning the panels with knob-control, wipe the panel and knobs with a damp soft cloth and dry with a dry cloth. Do not remove the knobs and gaskets underneath to clean the panel. The control panel and knobs may be damaged.
- While cleaning the inox panels with knob control, do not use inox cleaning agents around the knob. The indicators around the knob can be erased.
- Clean the touch control panels with a damp soft cloth and dry with a dry cloth. If your product has a key lock feature, set the key lock before performing control panel cleaning. Otherwise, incorrect detection may occur on the keys.

9.5 Cleaning the inside of the oven (cooking area)

Follow the cleaning steps described in the "General Cleaning Information" section according to the surface types in your oven.

Cleaning the side walls of the oven

The side walls in the cooking area can only be covered with enamel or catalytic walls. It varies by model. If there is a catalytic wall, refer to the "Catalytic surfaces" section for information.

If your product is a wire shelf model, remove the wire shelves before cleaning the side walls. Then complete the cleaning as described in the "General Cleaning Information" section according to the side wall surface type.

To remove the side wire shelves:

1. Remove the front of the wire shelf by pulling it on the side wall in the opposite direction.
2. Pull the wire shelf towards you to remove it completely.

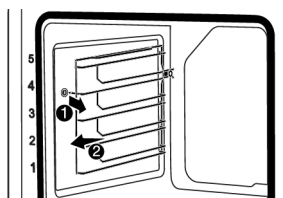

3. To reattach the shelves, the procedures applied when removing them must be repeated from the end to the beginning, respectively.

9.6 Easy Steam Cleaning

This allows cleaning of the dirt (not remaining for a long time) that is softened by the steam inside the oven and by the water droplets condensed in the internal surfaces of the oven easily.

1. Remove all accessories inside the oven.
2. Add 500 ml water into the tray and place it on the 2nd shelf of the oven.

i Refrain from using distilled or filtered water. Use ready-made waters only.

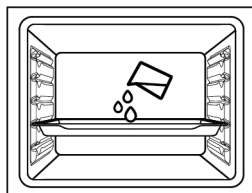

- Set the oven to the easy steam cleaning operating mode and operate it at 100°C for 15 minutes.

Immediately open the door and wipe the oven interiors with a wet sponge or cloth. Steam will be released when opening the door. This may pose a risk of burns. Be careful when opening the door.

For stubborn dirt, clean the product using dishwashing detergent, warm water and a soft cloth or sponge and dry it with a dry cloth.

i In the easy steam cleaning function, it is expected that the added water evaporates and condenses on the inside of the oven and the oven door in order to soften the light dirt formed in your oven. Condensation formed on the oven door may drip around when the oven door is opened. As soon as you open the oven door, wipe off the condensation.

(It varies depending on the product model. It may not be available on your product.) After the condensation inside the oven, puddle or moisture may occur in the pool channel under the oven. Wipe this pool channel with a damp cloth after use and dry it.

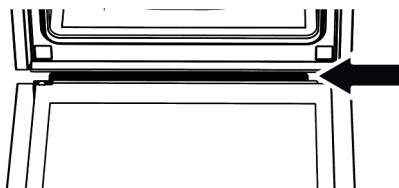

9.7 Cleaning the Oven Door

You can remove your oven door and door glasses to clean them. How to remove the doors and windows is explained in the sections "**Removing the oven door**" and "**Removing the inner glasses of the door**". After removing the door inner glasses, clean them using a dishwashing detergent, warm water and a soft cloth or sponge and dry them with a dry cloth. For lime residue that may form on the oven glass, wipe the glass with vinegar and rinse.

Removing the oven door

- Open the oven door.
- Open the clips in the front door hinge socket on the right and left by pushing them downwards as shown in the figure.
- Hinge types vary as (A), (B), (C) types according to the product model. The following figures show how to open each type of hinge.
- (A) type hinge is available in normal door types.

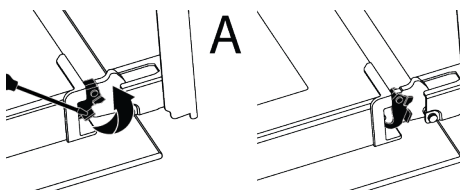

- (B) type hinge is available in soft closing door types.

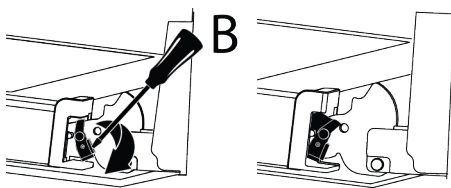

- (C) type hinge is available in soft opening/closing door types.

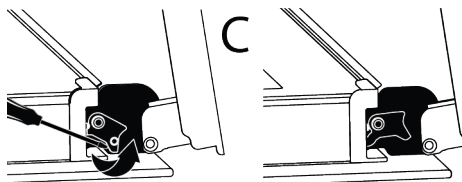

7. Get the oven door to a half-open position.

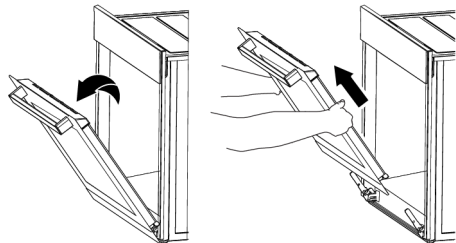

8. Pull the removed door upwards to release it from the right and left hinges and remove it.

i To reattach the door, the procedures applied when removing it must be repeated from the end to the beginning, respectively. When installing the door, be sure to close the clips on the hinge socket.

9.8 Removing the Inner Glass of The Oven Door

Inner glass of the product's front door may be removed for cleaning.

1. Open the oven door.

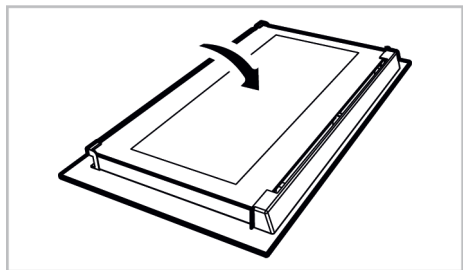

2. Remove the plastic component attached on the upper section of the front door by pulling it towards yourself.

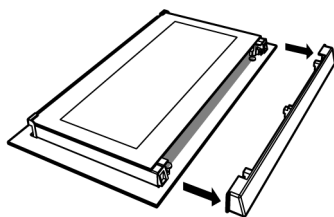

3. As shown in the figure, gently lift the innermost glass (1) towards "A" and then, remove it by pulling towards "B".

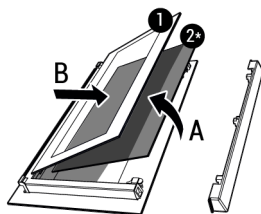

- 1 Innermost glass 2* Inner glass (it may not be available for your product)

4. If your product has an inner glass (2), repeat the same process to detach it (2).
5. The first step of regrouping the door is to reassemble the inner glass (2). Place the bevelled edge of the glass to meet the bevelled edge of the plastic slot. (If your product has an inner glass). Inner glass (2) must be attached to the plastic slot closest to the innermost glass (1).
6. While reassembling the innermost glass (1), pay attention to place the printed side of the glass on the inner glass. It is crucial to place the lower corners of the innermost glass (1) to meet the lower plastic slots.
7. Push the plastic component towards the frame until a "click" sound is heard.

9.9 Cleaning the Oven Lamp

In the event that the glass door of the oven lamp in the cooking area becomes dirty; clean using dishwashing detergent, warm water and a soft cloth or sponge and dry with a dry cloth. In case of oven lamp failure, you can replace the oven lamp by following the sections that follow.

Replacing the oven lamp

General information

- To avoid the risk of electric shock before replacing the oven lamp, disconnect the product and wait for the oven to cool. Hot surfaces may cause burns!
- This oven is powered by an incandescent lamp with less than 40 W, less than 60 mm in height, less than 30 mm in diameter, or a halogen lamp with G9 sockets with less than 60 W power. Lamps are suitable for operation at temperatures above 300 °C. Oven lamps are available from Authorised Services or licensed technicians. This product contains a G energy class lamp.
- The position of the lamp may differ from that is shown in the figure.
- The lamp used in this product is not suitable for use in the lighting of home rooms. The purpose of this lamp is to help the user see food products.
- The lamps used in this product must withstand extreme physical conditions such as temperatures above 50 °C.

If your oven has a round lamp,

1. Disconnect the product from the electricity.
2. Remove the glass cover by turning it counter clockwise.



3. If your oven lamp is type (A) shown in the figure below, rotate the oven lamp as shown in the figure and replace it with a new one. If it is type (B) model, pull it out as shown in the figure and replace it with a new one.

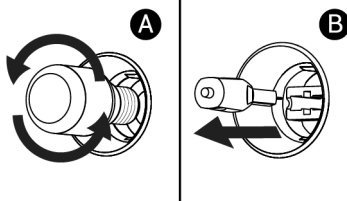

4. Refit the glass cover.

If your oven has a square lamp,

1. Disconnect the product from the electricity.
2. Remove the wire shelves according to the description.

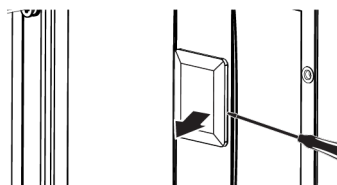

3. Lift the lamp's protective glass cover with a screwdriver. Remove the screw first, if there is a screw on the square lamp in your product.
4. If your oven lamp is type (A) shown in the figure below, rotate the oven lamp as shown in the figure and replace it with a new one. If it is type (B) model, pull it out as shown in the figure and replace it with a new one.

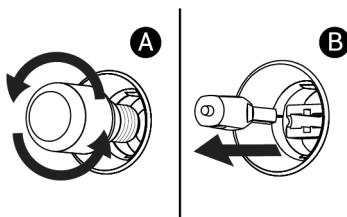

5. Refit the glass cover and wire shelves.

10 Troubleshooting

If the problem persists after following the instructions in this section, contact your vendor or an Authorized Service. Never try to repair your product yourself.

Steam is emanated while the oven is working.

- It is normal to see vapour during operation. >>> This is not an error.

Water droplets appear while cooking

- The steam generated during cooking condenses when it comes into contact with cold surfaces outside the product and may form water droplets. >>> This is not an error.

Metal sounds are heard while the product is warming and cooling.

- Metal parts may expand and make sounds when heated. >>> This is not an error.

The product does not work.

- Fuse may be faulty or blown. >>> Check the fuses in the fuse box. Change them if necessary or reactivate them.
- The appliance may not be plugged to the (grounded) outlet. >>> Check if the appliance is plugged in to the outlet.
- (If there is timer on your appliance) Keys on the control panel do not work. >>> If your product has a key lock, the key lock may be enabled, disable the key lock.

Oven light is not on.

- Oven lamp may be faulty. >>> Replace oven's lamp.
- No electricity. >>> Ensure the mains is operational and check the fuses in the fuse box. Change the fuses if necessary or reactivate them.

Oven is not heating.

- The oven may not be set to a specific cooking function and/or temperature. >>> Set the oven to a specific cooking function and/or temperature.
- No electricity. >>> Ensure the mains is operational and check the fuses in the fuse box. Change the fuses if necessary or reactivate them.

Dobrodošli!

Poštovani korisnici,

Hvala na odabiru proizvoda Indesit . Želimo da vam proizvod, proizveden uz visoki kvalitet i tehnologiju, pruži najbolju učinkovitost. Stoga, pažljivo pročitajte ovaj priručnik i svu drugu dokumentaciju koja je data prije uporabe proizvoda.

Obratite pažnju na sve informacije i upozorenja navedena u korisničkom priručniku. Na taj način ćete zaštititi sebe i svoj proizvod od opasnosti koje mogu nastati.

Sačuvajte uputstvo za upotrebu. Ako ovaj uređaj predate trećem licu, priložite i ovo uputstvo za upotrebu. Uslovi garancije, načini upotrebe i rješavanja problema za vaš proizvod navedeni su u ovom uputstvu.

Simboli i njihovi opisi u uputstvu za upotrebu:



Opasnost koja može za rezultat imati smrt ili ozljedu.



Važne informacije ili korisni savjeti za upotrebu.



Pročitajte uputstvo za upotrebu.



Upozorenje na vruću površinu.

NAPOMEN

A

Opasnost koja može za rezultat imati materijalnu štetu na proizvodu ili okolini.

Beko Europe Management Srl

Via Varesina 204, 20156 Milano, Italy

Sadržaj

1 Sigurnosna uputstva	38
1.1 Namjena.....	38
1.2 Sigurnost djece, ranjivih osoba i kućnih ljubimaca	38
1.3 Električna sigurnost.....	39
1.4 Siguran transport.....	41
1.5 Sigurna instalacija.....	41
1.6 Sigurna upotreba.....	42
1.7 Temperatura upozorenja	43
1.8 Upotreba pribora	43
1.9 Sigurnost kuhanja.....	44
1.10 Sigurno održavanje i čišćenje	45
2 Uputstva za zaštitu okoliša	46
2.1 Direktiva o otpadu	46
2.1.1 Usaglašenost sa direktivom WEEE i Odlaganje otpadnog proizvoda.....	46
2.2 Informacija o ambalaži	46
2.3 Preporuke za štednju energije	46
3 Vaš proizvod	47
3.1 Predstavljanje proizvoda.....	47
3.1.1 Jedinica za kuhanje	47
3.1.2 Sekcija za kuvanje	47
3.2 Predstavljanje kontrolne table pećnice.....	47
3.3 Radne funkcije pećnice.....	48
3.4 Dodaci uređaja.....	49
3.5 Korišćenje dodatka uređaja.....	50
3.6 Tehničke specifikacije.....	52
4 Instalacija	53
4.1 Pravo mjesto za ugradnju.....	53
4.2 Električno spajanje	54
4.3 Postavljanje proizvoda.....	55
5 Prva upotreba	56
5.1 Početno čišćenje	56
6 Kako koristiti ploču za kuhanje.....	57
6.1 Opće informacije o uporabi ploče za kuhanje.....	57
6.2 Rad ploča za grijanje	57
7 Korišćenje pećnice	58
7.1 Opće informacije o korišćenju pećnice.....	58
7.2 Rad kontrolne jedinice pećnice	58

8 Opće informacije o pečenju.....	59
8.1 Opće informacije o pečenju u pećnici	59
8.1.1 Peciva i hrana iz pećnice	59
8.1.2 Meso, riba i meso od peradi	62
8.1.3 Gril	62
8.1.4 Testna jela	63
9 Održavanje i čišćenje	64
9.1 Opće informacije o čišćenju	64
9.2 Pribor za čišćenje	66
9.3 Čišćenje ploče za kuhanje	66
9.4 Čišćenje kontrolne table	66
9.5 Čišćenje unutrašnjosti rerne (površina za spremanje hrane)...	66
9.6 Jednostavno parčišćenje.....	67
9.7 Čišćenje vrata pećnice	67
9.8 Skidanje unutarnjeg stakla sa vrata pećnice	68
9.9 Čišćenje sijalice u pećnici.....	69
10 Rješavanje problema.....	70



1 Sigurnosna uputstva

- Ovo poglavlje sadrži sigurnosne upute potrebne da bi spriječili rizik od fizičke ozljede i materijalne štete.
- Ako se proizvod preda nekom drugom licu za ličnu upotrebu ili u svrheupotrebe rabljenog uređaja, potrebno je dati i uputstvo za upotrebu, etikete proizvoda i druge relevantne dokumente i dijelove.
- Naša kompanija ne snosi odgovornost za štetu koja može nastati ako se ove upute ne poštuju.
- Nepoštovanje ovih uputa poništava odobrenu garanciju.
- Koristite samo originalne rezervne djelove i pribor.
- Ne popravljajte i ne mijenjajte nijednu komponentu proizvoda ako to nije jasno naznačeno u uputstvu za upotrebu.
- Ne vršite nikakve tehničke modifikacije na proizvodu.



1.1 Namjena

- Proizvod je namijenjen za primjenu u kućanstvima. Nije namijenjen za komercijalnu upotrebu.
- Ne koristite proizvod u vrtu, na balkonima ili na otvorenom. Uređaj je namijenjen upotrebi u kućanstvima i kuhinjama za

osoblje u prodavaonicama, kancelarijama i drugim radnim okruženjima.

- **UPOZORENJE:** Ovaj proizvod treba se koristiti samo za kuhanje. Ne smije se koristiti za druge namijene, na primjer za grijanje prostorija.
- Pećnica se može koristiti za odmrzavanje, pečenje, prženje hrane i pečenje hrane na roštilju.
- Ovaj proizvod ne smije se koristiti za grijanje kuhinjskog suđa, vješanjem peškira ili odjeće na ručke da bi se osušili.



1.2 Sigurnost djece, ranjivih osoba i kućnih ljubimaca

- Ovaj proizvod mogu koristiti djeca od 8 godina i starija i osobe koje su nedovoljno razvijene u fizičkim, senzornim ili mentalnim vještinama ili koje imaju nedostatak iskustva i znanja, sve dok su pod nadzorom ili obučene o sigurnoj upotrebi i opasnostima proizvoda.
- Djeca se ne smiju igrati proizvodom. Čišćenje i korisničko održavanje ne smiju obavljati djeca, osim ako ih neko ne nadgleda.

- Ovaj proizvod ne smiju koristiti osobe s ograničenim fizičkim, senzornim ili mentalnim sposobnostima (uključujući djecu), osim ako se čuvaju pod nadzorom ili dobiju potrebna uputstva.
- Djecu treba nadgledati kako bi se osiguralo da se ne igraju proizvodom.
- Električni proizvodi su opasni za djecu i kućne ljubimce. Djeca i kućni ljubimci se ne smiju igrati s proizvodom, penjati se na njega ili ulaziti u njega.
- Ne stavljajte predmete koje djeca mogu dohvatiti na proizvod.
- Okrenite ručku lonaca i tava na bočnu stranu pulta tako da djeca ne mogu zgrabiti i zapaliti.
- **UPOZORENJE:** Tokom upotrebe, dostupne površine proizvoda su vruće. Držite djecu podalje od proizvoda.
- Ambalažni materijal držite van dohvata djece. Postoji opasnost od povreda i gušenja.
- Kada su vrata otvorena, nemojte stavljati teške predmete na njih ili dozvoliti djeci da sjede na njima. Rerna se može prevrnuti ili oštetiti šarke vrata.
- Prije odbacivanja istrošenih i beskorisnih proizvoda:
 1. Odspojite utikač i izvadite ga iz utičnice.
 2. Odrežite kabl za napajanje i odspojite ga utikačem iz proizvoda.
 3. Poduzmite mjere predostrožnosti kako biste spriječili djecu da uđu u proizvod.
 4. Ne dozvolite djeci da se igraju proizvodom kada je u stanju mirovanja.



1.3 Električna sigurnost

- Ukopčajte proizvod u uzemljenu utičnicu zaštićenu osiguračem koji odgovara nazivnim vrijednostima na tipskoj pločici. Uzemljenje treba napraviti ovlašteni električar. Ne koristite proizvod koji nije uzemljen u skladu s lokalnim/nacionalnim propisima.
- Utikač ili električni priključak uređaja treba biti na lako dostupnom mjestu. Ako to nije moguće, mora postojati mehanizam (osigurač, prekidač, itd.) na električnoj instalaciji s kojom je proizvod spojen, u skladu s propisima o električnoj energiji koji odvaja sve polove od mreže.

- Iskopčajte proizvod ili isključite osigurač prije popravke, održavanja ili čišćenja.
 - Proizvod ukopčajte u uzemljenu utičnicu koja naponom i frekvencijom odgovara vrijednostima na tipskoj pločici.
 - (Ako vaš proizvod nema strujni kabl) koristite samo priključni kabl opisan u dijelu „Tehničke specifikacije”.
 - Ne gnječite strujni kabl ispod ili iza proizvoda. Na strujni kabl ne stavljajte teške predmete. Strujni kabl ne smije se savijati, gnječiti ni dolaziti u dodir s izvorom toplote.
 - Pripazite da strujni kabl nije prignječen prilikom postavljanja proizvoda na njegovo mjesto nakon sastavljanja ili čišćenja.
 - Tokom upotrebe stražnja površina pećnice postaje vruća. Kablovi za napajanje ne smiju dodirivati stražnju površinu proizvoda. Inače bi se mogao oštetiti.
 - Ne gnječite električne kablove s vratima pećnice i ne provlačite ih preko vrućih površina. U protivnom izolacija kablova može se otopiti i izazvati požar kao rezultat kratkog spoja.
 - Koristite samo originalni kabl. Ne koristite oštećene ili presječene kablove.
 - Ne koristite produžni kabl ili razdjelne utičnice za rukovanje proizvodom.
 - Kontaktirajte uvoznika ili ovlašteni servisni centar ako dužina strujnog kabla nije dovoljna.
 - Prijenosni izvori napajanja ili višestruki utikači mogu se pregrijati i izazvati požar. Višestruki utikači i prijenosni izvori napajanja držite podalje od proizvoda.
 - Ako je strujni kabl oštećen, smije ga zamijeniti proizvođač, ovlašteni servis ili osoba koju je odredio uvoznik kako bi se spriječile moguće opasnosti.
 - **UPOZORENJE:** Prije zamjene svjetla pećnice svakako odspojite proizvod iz strujnog napajanja i izbjegnite opasnost od strujnog udara. Iskopčajte proizvod ili isključite osigurač u razvodnoj kutiji.
- Ako vaš proizvod ima strujni kabl i utikač:
- Nikad ne stavljate utikač proizvoda u slomljenu, olabavljenu utičnicu ili ako utikač ispada iz utičnice. Pripazite je utikač potpuno

umetnut u utičnicu. U protivnom, priključci se mogu pregrijati ili izazvati požar.

- Izbjegavajte umetanje uređaja u utikače koji su masni, nečisti ili su možda izloženi vodi (poput onih pored radnih površina na koja voda može dospjeti). U suprotnom, postoji opasnost od kratkog spoja ili do smrti zbog strujnog udara.
- Utikač nikad ne dirajte mokrim rukama!
- Izvucite utikač iz strujne utičnice koristeći tijelo utikača a ne sam kabl.

1.4 Siguran transport

- Prije transporta proizvoda iskopčajte ga iz strujnog napajanja.
- Proizvod je težak, proizvod trebaju nositi barem dvije osobe.
- Ne koristite vrata i/ili ručke za transport ili premještanje proizvoda.
- Na uređaj ne stavljajte predmete. Uređaj nosite u uspravnom položaju.
- Kada trebate transportirati proizvod omotajte ga sa zaštitnom folijom sa zračnim jastučićima ili debelim kartonom i dobro zalijepite.

Dobro pričvrstite pomične dijelove proizvoda i tako spriječite oštećenja.

- Prije instalacije proizvoda provjerite je li proizvod oštećen nakon transporta. Kontaktirajte uvoznika ili ovlaštenu servisni centar ako je oštećen.

1.5 Sigurna instalacija

- Prije početka instalacije, isključite električni vod koji će se proizvod priključiti tako što ćete isključiti osigurač.
- Tokom transporta i održavanja uvijek nosite zaštitne rukavice. U protivnom, postoji opasnost od ozljeda zbog oštrih rubova!
- Prije instalacije proizvoda provjerite je li proizvod oštećen. Nemojte ga instalirati ako je uređaj oštećen.
- Nikada ne stavljajte proizvod na pod prekriven tepihom. Proizvod Inače će nedostatak protoka zraka ispod proizvoda uzrokovati pregrijavanje električnih dijelova. To će uzrokovati probleme s vašim proizvodom.
- Proizvod se treba staviti direktno na čistu, ravnu i čvrstu površinu. Ne smije se stavljati na podnožje ili krevetnu ploču. Proizvodi se ne smiju stavljati na kartonske ili plastične tanjure.

- Izravna sunčeva svjetlost i izvori toplote, poput električnih ili plinskih grijalica, ne smiju biti smješteni u području u kojem se instalira proizvod.
- Područja oko ventilacionih otvora proizvoda ne smiju biti blokirana.
- Ne postavljajte proizvod blizu prozora. Postoji opasnost da plamen ploče za kuhanje zapali zavjese i zapaljive materijale oko ploče. Kada otvorite prozor kuhinjsko posuđe se može prevrnuti.
- Ne postavljajte proizvod blizu prozora. Kada otvorite prozor kuhinjsko posuđe se može prevrnuti.
- Kako biste izbjegli pregrijavanje, instalacija proizvoda ne smije se provoditi iza ukrasnih poklopaca.
- U slučajevima kada se crijevo/ cijev za plin ili plastična cijev za vodu nalazi iza određenog područja za ugradnju proizvoda, treba garantovati da nema kontakta između proizvoda i ovih vodova. U suprotnom bi se crijevo/cijev moglo zgnječiti.
- Ako postoji utičnica iza mjesta na kojem će se proizvod instalirati, tada mora biti osigurano da proizvod ne dođe

u kontakt s utičnicom ni s utikačem ukopčanim u utičnicu.

- Na stražnjoj ili bočnoj stijenci mjesta na kojem će se proizvod instalirati ne smije biti crijevo za plin, plastična cijev za vodu i utičnica. U suprotnom, mogu se deformirati zbog toplodnog uticaja tokom rada ploče za kuhanje i mogu predstavljati sigurnosni rizik.

1.6 Sigurna upotreba

- Provjerite je li proizvod isključen nakon svake upotrebe.
- Ako proizvod ne koristite duže vrijeme iskopčajte ga iz strujne utičnice ili isključite napajanje u razvodnoj kutiji.
- Ne koristite proizvod ako se pokvari ili ošteti tokom upotrebe. tada isključite proizvod iz strujne utičnice. Kontaktirajte uvoznika ili ovlašteni servisni centar.
- Ne koristite proizvod ako mu je staklo na prednjim vratima napuklo ili uklonjeno. U protivnom postoji opasnost od ozljeda i štete za okoliš.
- Nikada nemojte stati na uređaj.

- Nikada ne koristite proizvod kad vam je smanjena sposobnost prosuđivanja ili koordinacija zbog konzumacije alkohola i/ili lijekova.
- Zapaljivi predmeti ne smiju se držati unutar i oko prostora za kuhanje. U suprotnom, to može dovesti do požara.
- Ručka pećnice nije namijenjena za sušenje kuhinjskih krpa. Kada koristite proizvod ne vješajte ručnika, rukavica ili slične tkanine na ručku.
- Šarke na vratima proizvoda pomiču se prilikom otvaranja i zatvaranja vrata i mogu se zaglaviti. Prilikom otvaranja/zatvaranja vrata ne držite dio sa šarkama.
- Ovaj proizvod nije prikladan za upotrebu s daljinskim upravljačem ili vanjskim satom.
- Pored proizvoda ne stavljajte zapaljive/eksplozivne materijale jer će površine biti vruće prilikom rada.
- Održavajte rastojanje kada otvarate vrata pećnice tokom ili na kraju kuhanja. Para vam može opeći ruke, lice i/ili oči.
- Tokom rada proizvod je vruć. Trebate izbjegavati dodirivanje vrućih dijelova, unutrašnjosti pećnice i grijaćih elemenata.
- Prilikom rukovanja proizvodom uvijek nosite rukavice za pećnicu otporne na toplotu.
- **UPOZORENJE:** Opasnost od požara: ne odlažite predmete na površine za kuhanje.

1.8 Upotreba pribora

- Važno je da žičana rešetka roštilja i protvan budu ispravno postavljeni na žičanu rešetku. Detaljne informacije pogledajte u dijelu „**Upotreba pribora**“.
- Zatvorite vrata pećnice nakon što ste pribor potpuno gurnuli u prostor za kuhanje, inače bi mogli udariti u staklo vrata i oštetiti ga.
- **UPOZORENJE:** Koristite samo štitnike za ploču koje je izradio proizvođač kuhala ili koje je proizvođač kuhala u korisničkim uputama naveo kao prikladne ili štitnike za ploču ugrađene u kuhalo.

1.7 Temperaturna upozorenja

- **UPOZORENJE:** Kada se proizvod koristi, proizvod i njegovi dostupni dijelovi bit će vrući. Trebate izbjegavati dodirivanje proizvoda i grijaćih elemenata. Djecu mlađu od 8 godina treba držati podalje od proizvoda osim ako nisu pod stalnim nadzorom.

Upotreba neprimjerenih štitnika može uzrokovati nezgode.

1.9 Sigurnost kuhanja

- **UPOZORENJE:** Postupak kuhanja treba nadzirati. Kratkotrajni procesi pripreme moraju se konstantno nadgledati.
- **UPOZORENJE:** Pri kuhanju na krutom ili tečnom ulju opasno je ostaviti ploču za kuhanje bez nadzora jer može doći do požara. NIKADA ne pokušavajte ugasiti vatru vodom; isključite proizvod iz električne mreže, a zatim prekrijte plamen pokrivačem ili vatrogasnom tkaninom (itd.).
- Budite oprezni kada koristite alkohol u hrani. Alkohol isparava na visokim temperaturama i može izazvati požar jer se može zapaliti kada dođe u kontakt sa vrućim površinama.
- Ostaci hrane u prostoru za kuhanje, poput ulja, mogu se zapaliti. Očistite te ostatke prije kuhanja.
- Opasnost od trovanja hranom. Ne čuvajte hranu u pećnici duže od sat vremena prije i posle pripreme. U suprotnom možete izazvati trovanje hranom ili bolesti.

- Ne zagrijevajte zatvorene konzerve i staklene tegle u pećnici. Pritisak koji bi se stvorio u konzervi/tegli može izazvati njeno pucanje.
- Pleh za pečenje, tanjure ili aluminijumsku foliju ne postavljajte direktno na dno pećnice. Akumulirana toplota može oštetiti osnovu pećnice. Vodite računa o sljedećim mjerama opreza kada koristite masni pergament papir ili slične materijale:
 - Stavite papir za pečenje u posuđe ili pribor za pećnicu (pleh, žičana rešetka, itd.) s hranom i stavite ga u prethodno zagrijanu pećnicu.
 - Kako biste spriječili rizik od dodirivanja grijača pećnice i ometanja protoka vrućeg zraka, uklonite sve suvišne dijelove masnog papira koji vise s pribora ili posuda. Nemojte koristiti masni papir na temperaturama pećnice višim od maksimalne temperature uporabe koju navodi proizvođač. Nikada ne stavljajte papir za pečenje na dno pećnice.
 - Nemojte ga stavljati na pribor tokom predgrijavanja.

- Uvijek pritisnite tanjurom ili sličnim predmetom kako biste spriječili da materijal leti okolo zbog cirkulacije zraka unutar pećnice.
- Pokrijte samo potrebnu površinu unutar pladnja.
- Nakon svake uporabe, pladanj treba očistiti i zamijeniti sav masni papir ili slične materijale korištene u pladnju. Inače, tečnosti koje kapaju na pladanj mogu izazvati dimljenje ili čak zapaliti plamen.
- Protok zraka stvara se kada se poklopac proizvoda otvori. Masni papir može doći u dodir s grijačima i zapaliti se.
- Kada za prženje koristite rešetku za pečenje, na donju rešetku treba postaviti pladanj. Inače, ulje od hrane i druge komponente koje kapaju na dno pećnice mogu stvoriti jak dim i izazvati plamen.
- Za vrijeme grilovanja zatvorite vrata pećnice. Vruće površine mogu izazvati opekotine!
- Hrana koja nije adekvatna za grilovanje predstavlja opasnost od nastanka požara.

Grilujte samo hranu koja se smije obrađivati na temperaturi za intenzivno grilovanje. Ne stavljajte hranu predaleko u stražnji dio rešetke. Ovo je najtoplije područje i masna hrana se može zapaliti.



1.10 Sigurno održavanje i čišćenje

- Pričekajte da se proizvod ohladi prije čišćenja. Vruće površine mogu izazvati opekotine!
- Proizvod nikad ne perite prskanjem ili ulijevanjem vode u njega! Postoji opasnost od strujnog udara!
- Nemojte koristiti parne čistače za čišćenje proizvoda jer to može izazvati strujni udar.
- Nemojte koristiti jaka abrazivna sredstva za čišćenje, metalne strugače, jastučice za ribanje, žicu za pranje posuđa ili izbjeljivač za čišćenje stakla prednjih vrata pećnice i stakla gornjih vrata pećnice (ako je u opremi). Ti materijali mogu ogrepsti ili slomiti staklene površine.

2 Uputstva za zaštitu okoliša

2.1 Direktiva o otpadu

2.1.1 Usaglašenost sa direktivom WEEE i Odlaganje otpadnog proizvoda

Ovaj proizvod je usklađen s Direktivom EU WEEE (2012/19/EU). Ovaj proizvod nosi simbol klasifikacije za odlaganje električne i elektronske opreme (WEEE).



Ovaj proizvod je proizveden od visokokvalitetnih dijelova i materijala koji se mogu ponovno koristiti i pogodni su za recikliranje. Stoga, na kraju njegovog vijeka trajanja ne

zbrinjavajte ovaj otpadni proizvod s ostalim redovnim otpadom iz domaćinstva.

Ondesite ga u sabirni centar za recikliranje električne i elektroničke opreme.

Informacije o navedenim sabirnim centrima možete dobiti od lokalne uprave. Pravilno odlaganje otpadnih uređaja pomaže u sprječavanju negativnih uticaja na okoliš i zdravlje ljudi.

Usklađenost sa RoHS direktivom:

Proizvod koji ste kupili je usklađen s Direktivom EU RoHS (2011/65/EU). On ne sadrži štetne i zabranjene materijale navedene u Direktivi.

2.2 Informacija o ambalaži

Materijali za pakiranje proizvoda su proizvedeni od sekundarnih sirovina u skladu s našim nacionalnim propisima za zaštitu okoliša. Ambalažni otpad nemojte odlagati sa kućnim ili drugim otpadom,

odnesite ga na mjesta za prikupljanje ambalažnog materijala određena od strane lokalnih organa.

2.3 Preporuke za štednju energije

Prema EU 66/2014, informacije o energetskej efikasnosti mogu se naći na računu proizvoda koji se isporučuje uz proizvod.

Sljedeći prijedlozi će vam pomoći da svoj proizvod upotrebljavate na ekološki i energetski učinkovit način:

- Zamrznutu hranu odmrznite prije pečenja.
- U pećnici koristite tamne ili emajlirane posude koje bolje prenose toplotu.
- Ako je navedeno u receptu ili uputstvu za upotrebu, uvijek izvršite prethodno zagrijavanje. Ne otvarajte vrata pećnice često tijekom pečenja.
- Isključite proizvod 5 do 10 minuta prije isteka vremena za produženo pečenje. Mžete uštedjeti do 20% električne energije upotrebom preostale topline.
- Pokušajte da istovremeno pečete više jela u pećnici. Možete istovremeno spremati hranu postavljanjem dvije posude na rešetku. Osim toga, ako spremate jela jedno za drugim, to će uštedjeti energiju jer pećnica neće izgubiti na svojoj toplini.
- Koristite lonce/tave veličine i poklopca koji odgovaraju zoni kuhanja. Uvijek odaberite lonac veličine koja odgovara vašim obrocima. Posude neprikladne veličine zahtijevaće energije više nego što je potrebno.
- Održavajte površine za pečenje na ploči za kuhanje i dno posude čistima. Nečistoća smanjuje prijenos toplote između područja za pečenje i dna posude.

3 Vaš proizvod

U ovom odjeljku možete pronaći pregled i osnovne namjene kontrolne table proizvoda. Moguće su razlike u slikama i nekim karakteristikama u zavisnosti od vrste proizvoda.

3.1 Predstavljanje proizvoda

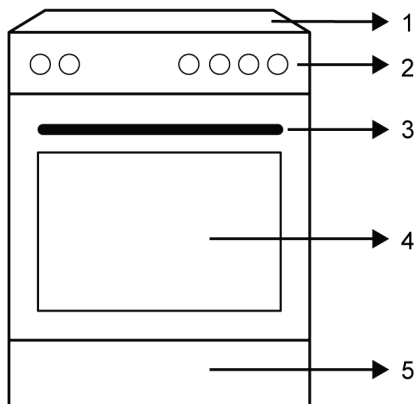

- 1 Dio ploče za kuhanje
- 2 Kontrolna tabla
- 3 Ručka
- 4 Vrata
- 5 Donji dio

3.1.1 Jedinica za kuhanje

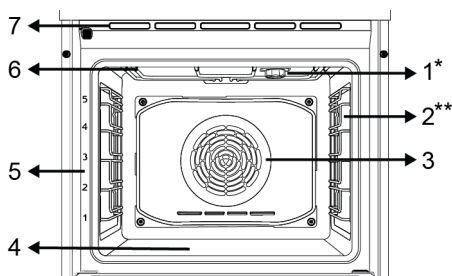

- 1 Sijalica

- 2 Žičane police
- 3 Motor ventilatora (iza čelične ploče)
- 4 Donji grijač (ispod čelične ploče)
- 5 Pozicije polica
- 6 Gornji grijač
- 7 Ventilacioni otvori

* Razlikuje se ovisno o modelu proizvoda. Vaš proizvod možda nema sijalicu ili se vrsta i lokacija sijalice mogu razlikovati od slike.

** Razlikuje se ovisno o modelu proizvoda. Vaš proizvod možda nije opremljen žicom. Na slici je kao primjer prikazan proizvod sa žicom.

3.1.2 Sekcija za kuvanje

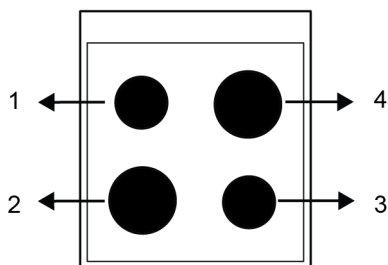

- 1 Stražnji lijevi - električna ploča za kuhanje
- 2 Prednji lijevi - električna ploča za kuhanje
- 3 Prednji desni - električna ploča za kuhanje
- 4 Stražnji desni - električna ploča za kuhanje

3.2 Predstavljanje kontrolne table pećnice

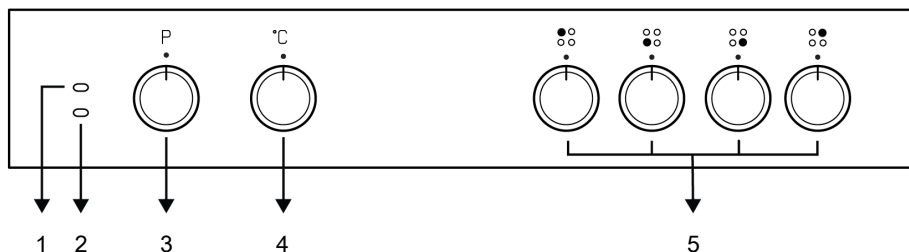

- | | |
|--|--|
| <p>1 Alarmna lampica aktivne ploče za kuhanje</p> <p>3 Dugme za izbor funkcije</p> <p>5 Gumbi za upravljanje pločom za kuhanje</p> | <p>2 Sijalica termostata</p> <p>4 Dugme za izbor temperature</p> |
|--|--|

Ako postoji dugme(dugmad) koje kontroliše(u) vaš proizvod, u nekim modelima to(ta) dugme(dugmad) izlazi(e) kada se pritisne(u) (umetnuta dugmad). Da biste izvršili postavke pomoću ovih dugmadi, prvo pritisnite odgovarajuće dugme i ono će se pojaviti van. Nakon postavke, pritisnite ga ponovo i vratite dugme u prvobitni položaj.

Dugme za izbor funkcije

Funkcije rada pećnice možete odabrati pomoću gumba za odabir funkcije. Okrenite lijevo/desno iz zatvorenog (gornjeg) položaja za odabir.

Dugme za izbor temperature

Možete odabrati temperaturu koju želite kuhati pomoću gumba za temperaturu. Okrenite u smjeru kazaljke na satu iz zatvorenog (gornjeg) položaja za odabir.

Indikator unutrašnje temperature pećnice

Unutrašnju temperaturu pećnice možete razumjeti iz lampice temperature. Lampica termostata nalazi se na kontrolnoj tabli.



Lampica termostata se uključuje kada proizvod počne da radi, a lampica termostata se gasi kada dostigne podešenu temperaturu. Kada temperatura u pećnici padne ispod postavljene temperature, lampica termostata se ponovo uključuje.

Gumbi za upravljanje pločom za kuhanje

Svojom pločom za kuvanje možete upravljati pomoću dugmadi za kontrolu ploče. Svako dugme upravlja odgovarajućom ringlom. Možete zaključiti kojom ringlom upravlja po simbolima na kontrolnoj tabli.

3.3 Radne funkcije pećnice

Na tabeli funkcija; prikazane su radne funkcije koje možete koristiti u vašoj pećnici i najviše i najniže temperature koje se mogu podesiti za ove funkcije. Redoslijed prikazanih režima rada može se razlikovati od rasporeda na vašem proizvodu.

Simbol funkcije	Opis funkcije	Temperaturni opseg (°C)	Opis i upotreba
	Gornji i donji grijač	*	Hranu zagrijevaju gornji i donji grijač istovremeno. Pogodno za torte, kolače ili peciva i variva u kalupima za pečenje. Pečenje u samo jednom plehu.
 	Donji grijač	*	Uključen je samo donji grijač. Pogodan je za hranu za koju želite da na dnu malo potamni. Ovu funkciju treba koristiti i za jednostavno paročišćenje.
	Gornji i donji grijač + ventilator	*	Vrući vazduh zagrijan gornjim i donjim grijačima raspoređuje se ravnomjerno i brzo kroz pećnicu pomoću ventilatora. Pečenje u samo jednom plehu.
	Puni gril	*	Veliki gril na gornjem dijelu pećnice radi. Pogodan je za grilovanje velikih količina.
	Niski gril + ventilator	*	Vruć vazduh zagrijan tokom funkcije malog grila brzo se raspoređuje u pećnici ventilatorom. Pogodan je za grilovanje malih količina.
	Pojačivač	-	Svi grijači u pećnici su u funkciji. Ova radna funkcija se koristi za brzo dovođenje peći na željenu temperaturu (prethodno zagrijavanje). Ne koristite ga za pečenje hrane.

* Vaš proizvod radi u temperaturnom rasponu navedenom na regulatoru temperature.

3.4 Dodaci uređaja

Uz vaš uređaj su isporučeni razni dodaci. U ovom odjeljku dostupni su opisi dodataka i opisi pravilnog korišćenja. Dodaci koji se dostavljaju uz uređaj se mogu razlikovati u zavisnosti od modela uređaja. Svi dodaci opisani u uputstvu za upotrebu možda neće biti dostupni na vašem proizvodu.

 Plehovi unutar vašeg uređaja se mogu deformisati zbog uticaja temperature. Navedeno neće uticati na funkcionalnosti. Deformacija nestaje kada se pleh ohladi.

Standardni pleh

Koristi se za tijesta, smrznutu hranu i velike komade pečenja.

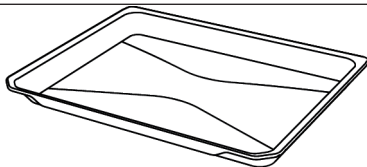

Žičani gril

Koristi se za pečenje ili stavljanje hrane koja će se peći, pržiti ili kuhati u kaserolama na željenu policu.

Na modelima sa žičanim policama :

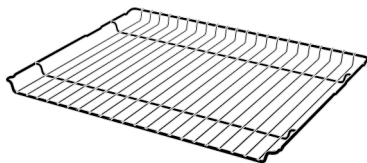

Na modelima bez žičanih policica :

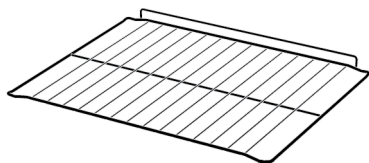

3.5 Korišćenje dodatka uređaja

Police za pripremu hrane

Postoji 5 nivoa položaja policica u prostoru za pripremu hrane. Redosljed policica je označen brojevima na prednjem okviru pećnice.

Na modelima sa žičanim policama :

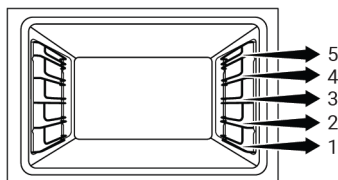

Na modelima bez žičanih policica :

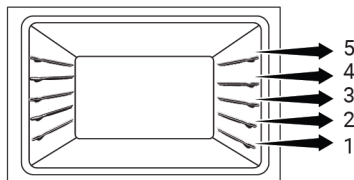

Postavljanje žičanog roštilja na police za kuvanje

Na modelima sa žičanim policama :

Od ključne je važnosti pravilno postaviti žičanu rešetku na žičane bočne police. Dok postavljate žičani roštilj na željenu policu, otvoreni dio mora biti na prednjoj strani. Za bolje kuvanje, žičani roštilj mora biti pričvršćen na mjestu zaustavljanja žičane policice. Ne smije prijeći preko tačke zaustavljanja da bi u kontaktu sa zadnjim zidom pećnice.

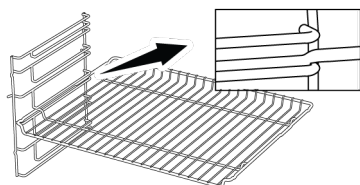

Na modelima bez žičanih policica :

Ključno je pravilno postaviti žičani roštilj na bočne police. Žičani roštilj ima jedan smjer kada ga stavljate na policu. Dok postavljate žičani roštilj na željenu policu, otvoreni dio mora biti na prednjoj strani.

BS

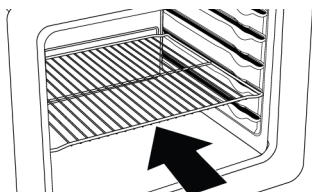

Postavljanje pleha na police za pečenje

Na modelima sa žičanim policama :

Takođe je od presudnog značaja pravilno postaviti plehove na žičane bočne police. Dok postavljate pleh na željenu policu, njegova strana dizajnirana za držanje mora biti okrenuta sa prednje strane. Za bolje rezultate pečenja, pleh mora biti pričvršćen graničnikom za žičanu policu. Ne smije mimoći taj graničnik i dodirivati stražnji zid pećnice.

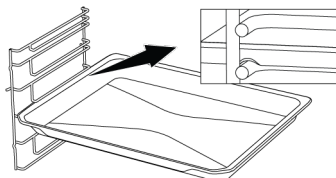

Na modelima bez žičanih policica :

Takođe je od presudnog značaja propisno postaviti plehove na bočne police. Pleh se u samo jednom smjeru može postaviti na policu. Dok postavljate pleh na željenu policu, njegova strana dizajnirana za držanje mora biti okrenuta sa prednje strane.

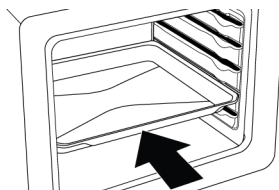

Funkcija zaustavljanja žice za gril

Uređaj ima funkciju graničnika koji sprječava prevrtanje žice za gril sa žičane police. Ovom funkcijom lako i bezbjedno možete izvaditi hranu. Dok uklanjate žicu za gril, možete je povući prema naprijed dok ne dosegne graničnik. Morate preći preko graničnika da biste ga potpuno izvukli.

Na modelima sa žičanim policama :

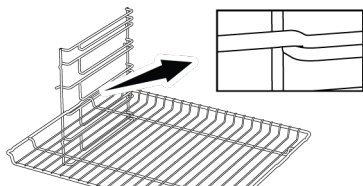

Na modelima bez žičanih policama :

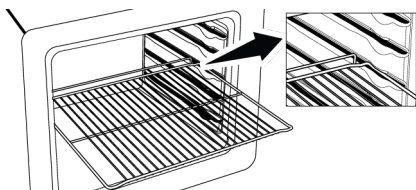

Funkcija graničnika pleha - Na modelima sa žičanim policama

Postoji i funkcija graničnika koji sprječava ispadanje pleha sa žičane police. Prilikom uklanjanja pleha, otpustite ga sa zapreke sa zadnje strane i povucite prema sebi dok se ne dosegne prednja strana. Morate preći preko graničnika da biste ga potpuno izvukli.

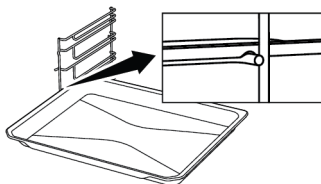

Pravilno postavljanje žičane police i pleha na teleskopske šine - Na modelima sa žičanim policama i teleskopskim modelima

Zahvaljujući teleskopskim šinama, tacne ili žičane police mogu se lako postaviti i ukloniti. Treba paziti da ladice i žičane police postavite na teleskopske šine kao što je prikazano na donjoj slici.

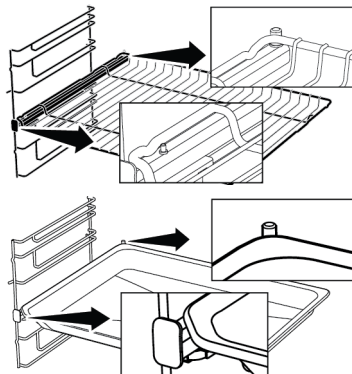

3.6 Tehničke specifikacije

Opšte specifikacije	
Vanjske dimenzije proizvoda (visina/širina/dubina) (mm)	850 /600 /600
Napon/Frekvencija	220-240 V ~ 50 Hz
Tip i presjek kabla koji se koristi / adekvatan za upotrebu u proizvodu	min. H05VV-FG 3 x 2,5 mm ² / 5 x 1,5 mm ²
Ukupna potrošnja električne energije (kW)	8,4
Vrsta pećnice	Pećnica s dodatkom ventilatora
Prednji lijevi	električna ploča za kuhanje
Dimenzija	180 mm
Snaga	2000 Š
Stražnji lijevi	električna ploča za kuhanje
Dimenzija	145 mm
Snaga	1000 Š
Prednji desni	električna ploča za kuhanje
Dimenzija	145 mm
Snaga	1000 Š
Stražnji desni	električna ploča za kuhanje
Dimenzija	180 mm
Snaga	2000 Š

Osnove: Informacije o energetskej naljepnici kućnih električnih pećnica date su u skladu sa standardom EN 60350-1 / IEC 60350-1. Vrijednosti su određene u funkcijama Gornji i donji grijač ili (ako postoji) Gornji i donji grijač + ventilator sa standardnim opterećenjem.

Klasa energetske efikasnosti se određuje u skladu sa sljedećim prioritetima u zavisnosti od toga da li relevantne funkcije postoje na uređaju ili ne. 1-Eko grijanje s ventilatorom , 2-Grijanje s ventilatorom , 3-Niski gril + ventilator , 4-Gornji i donji grijač.



Tehničke specifikacije mogu biti promijenjene bez prethodne obavijesti zbog poboljšanja kvaliteta proizvoda.



Slike u ovom uputstvu su šematske i možda se neće u potpunosti poklapati s vašim uređajem.



Vrijednosti navedene na naljepnici uređaja ili u dokumentaciji koju ste dobili uz uređaj su dobijene u laboratorijskim uslovima u skladu s relevantnim standardima. Ovisno o uslovima rada i okoline proizvoda, te vrijednosti mogu biti različite.

4 Instalacija

! Opće informacije

- Konsultirajte najbližeg ovlaštenog zastupnika za održavanje radi instalacije ovog proizvoda. Budite sigurni da su električne i plinske instalacije na svom mjestu prije nego pozovete ovlaštenog zastupnika za održavanje da biste proizvod učinili spremnim za rad. Ako ne, pozovite kvalifikovanog električara i instalatera kako biste omogućili tražene postupke. Proizvođač se neće držati odgovornim za oštećenja nastala usljed procedura koje su izvodile neovlaštene osobe i garancija može biti nevažeća.
- Priprema lokacije i elektro i plinske instalacije za ovaj proizvod je u nadležnosti korisnika.
- Prilikom instalacije, uređaj mora biti spojen u skladu sa svim lokalnim propisima o plinskim i/ili električnim instalacijama.
- Prije instalacije, izvršiti vizuelno provjeru da li na proizvodu ima bilo kakvih nedostataka.

4.1 Pravo mjesto za ugradnju

- Stavite proizvod na tvrdnu površinu zbog zračnih kanala ispod proizvoda. Ne smije se postavljati na postolje ili postolje. Noge proizvoda ne bi trebalo da uranjaju na mekane površine, npr. tepih itd.
- Kuhinjski pod mora biti takav da može podnositi težinu uređaja i dodatnu težinu posuđa i pribora za kuhanje i hrane.
- Ovaj proizvod je uređaj klase 1 prema EN 30-1-1 standardu, tj. može se postavljati sa stražnjim dijelom i jednom stranom uz kuhinjske zidove, kuhinjski namještaj ili opremu bilo koje veličine. Kuhinjski namještaj ili oprema sa druge strane mogu biti samo iste veličine ili manji.
- Može se koristiti uz ormariće sa obje strane, ali da bi se ostvarila minimalna udaljenost od 400mm iznad nivoa ploče za kuhanje, ostavite zazor sa strane od 65mm između uređaja i zida, pregrade ili visokog plakara.

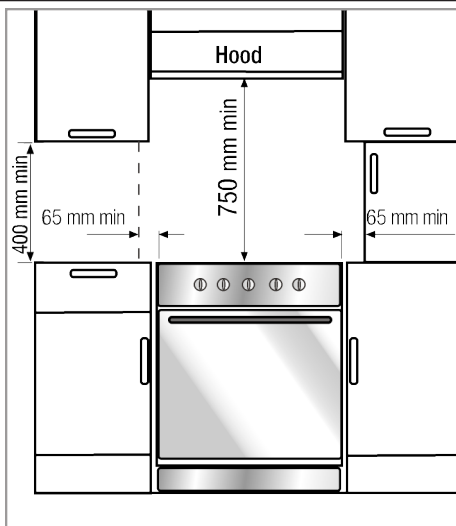

- Može se koristiti i kao samostojeći uređaj. Omogućite minimalnu razdaljinu od 750 mm iznad površine ploče za kuhanje.
- Kada je potrebno ugraditi kuhinjsku napu iznad štednjaka, pogledajte priložena uputstva od proizvođača kuhinjske nape za pravilno određivanje visine ugradnje. Ako nije definirana bilo koja veličina u priručniku za nape, ta visina treba biti najmanje 650 mm.
- Kuhinjski namještaj koj se postavlja pored uređaja mora biti otporan na toplotu (minimalno 100 °C).

Sigurnosni lanac

Uređaj se mora osigurati od neuravnoteženosti korištenjem lanca koji se isporučuje uz pećnicu.

Upozorenje – opasnost od prevrtanja!

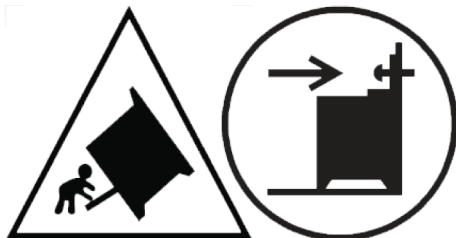

Upozorenje: Kako bi se spriječilo prevrtanje uređaja, ovo sredstvo za stabilizaciju mora biti ugrađeno. Pogledajte uputstva za instalaciju.

Ako vaš proizvod ima 2 sigurnosna lanca; FPričvrstite kuku (1) koristeći odgovarajući klin na kuhinjski zid (6) i povežite sigurnosni lanac (3) na kuku pomoću mehanizma za zaključavanje (2).

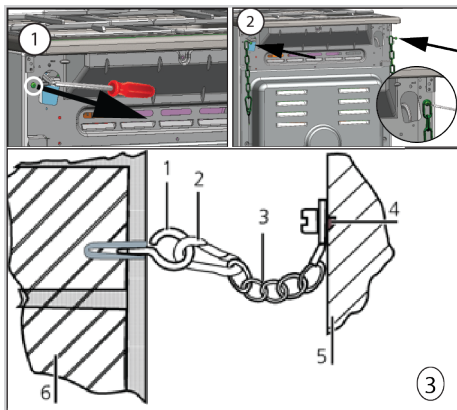

- 1 Kuka za stabilnost
- 2 Mehanizam za zaključavanje
- 3 Sigurnosni lanac
- 4 Čvrsto pričvrstite lanac na stražnji dio štednjaka
- 5 Stražnji dio štednjaka
- 6 Kuhinjski zid

Ako vaš proizvod ima 1 sigurnosni lanac;

Uređaj se mora osigurati od neuravnoteženosti korištenjem isporučenog jednog sigurnosnog lanca na vašoj pećnici.

Slijedite dolje navedene korake koji su dati na slici da biste pričvrstili sigurnosni lanac na vašem proizvodu.

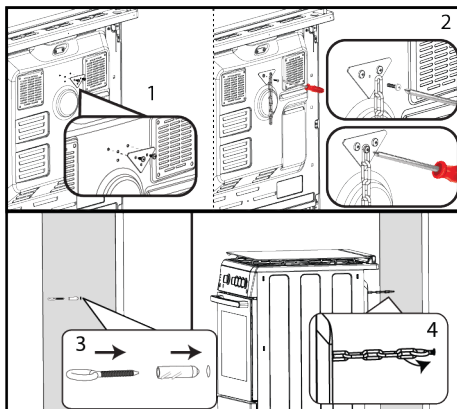

i Lanac za stabilnost treba biti kratak koliko god je to praktično moguće kako bi se izbjeglo naginjanje pećnice prema naprijed i dijagonalno da bi se izbjeglo naginjanje pećnice na stranu. Lanac za stabilnost štednjaka za štednjake koji nisu dizajnirani sa prorezom za konzolno pričvršćivanje.

4.2 Električno spajanje

- Prije početka bilo kakvih radova na električnoj instalaciji, isključite proizvod iz napajanja. Postoji opasnost od električnog udara!
- Priključite proizvod na uzemljenu utičnicu/vod koji su zaštićeni minijaturnom automatskom sklopkom odgovarajućeg kapaciteta kao što je navedeno u tabeli "Tehničke specifikacije". Neka uzemljenje uradi kvalifikovani električar dok se proizvod koristi sa ili bez transformatora. Naša kompanija neće biti odgovorna za bilo kakva oštećenja koja mogu nastati zbog korištenja proizvoda bez uzemljenja u skladu s lokalnim propisima.
- Proizvod mora biti povezan s mrežnim napajanjem samo od strane ovlaštene i kvalificirane osobe. Proizvođač ne snosi odgovornost za štetu nastalu postupcima koje provode neovlaštene osobe.

- Kabal za napajanje se ne smije pritiskati, savijati ili gnječiti, niti doći u kontakt sa vrućim dijelovima na proizvodu. Oštećeni kabal za napajanje se mora zamijeniti od strane ovlaštenog servisnog zastupnika. U suprotnom, postoji rizik od elektro šoka, kratkog spoja ili požara!
- Podaci napojnog voda moraju odgovarati podacima navedenim na etiketi o tipu proizvoda. Pločica sa podacima o napajanju može se vidjeti kada se otvore vrata ili donji poklopac ili se nalazi na stražnjem zidu jedinice, ovisno o tipu jedinice. Napojni kabal vašeg proizvoda se mora slagati sa vrijednostima iz tabele "Tehničke specifikacije".
- Dok obavljate spajanje žica, morate se pridržavati nacionalnih/lokalnih propisa o električnoj energiji i morate koristiti odgovarajuću utičnicu/vod i utikač za pećnicu. U slučaju da su energetska ograničenja proizvoda izvan trenutnog kapaciteta nosivosti utikača i utičnice/voda, proizvod se mora spojiti direktno preko fiksne električne instalacije, bez korištenja utikača i utičnice/voda.
- **Ako će proizvod biti spojen izravno na napajanje:** Ako nije moguće odspojiti sve stupove napajanja, mora biti spojena jedinica za odvajanje s najmanje 3 mm kontaktnog zastoja (osigurači, sigurnosni prekidači, kontaktori) i svi stubovi ove jedinice za isključivanje moraju biti iste (ili iznad) vrijednosti proizvoda u skladu s IEE smjernicama. Nepoštivanje ovih uputstava može uzrokovati operativne probleme i poništiti garanciju proizvoda.
- Preporučuje se dodatna zaštita sklopnim prekidačem.

Ako se proizvod proizvodi bez kabela i utikača:

- Kabel za napajanje koji je definiran u tehničkoj tablici mora biti povezan s proizvodom slijedeći upute. Napajanje kabela ne smije biti dulje od 2 m zbog sigurnosnih razloga.
- Otvorite poklopac priključnog bloka odvijačem.

- Umetnite kabl za napajanje kroz stezaljku ispod terminala i pričvrstite ga na glavno telo integrisanim vijkom na komponenti za stezanje kabela.
- Priključite kablove prema priloženom dijagramu.

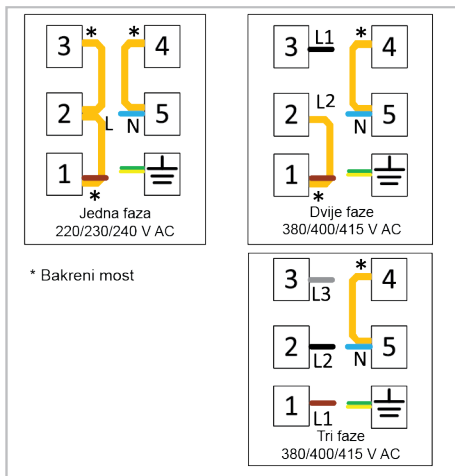

Ako je vaš tip kabela za napajanje tipa 3 provodnika, za 1-fazni priključak:

- Smeđa/Crna = L (Faza)
- Plava = N (Neutralno)
- Zelena/žuta žica = (E) ⊕ (Uzemljenje)

Ako je vaš tip kabela za napajanje tipa 5 provodnika, za trofazni priključak:

- Smeđa = L1 (Faza)
- Crna = L2 (Faza)
- Siva = L3 (Faza)
- Plava = N (Neutralno)
- Zelena/žuta žica = (E) ⊕ (Uzemljenje)

- Nakon dovršetka priključaka žice, zatvorite poklopac stezaljke.
- Priključite kabl za napajanje tako da ne dodiruje proizvod i ne pritisne se između proizvoda i zida.

4.3 Postavljanje proizvoda

1. Guraj proizvod prema zidu kuhinje.
2. Pričvrstite sigurnosni lanac koji ste spojili na proizvod za zid.
3. Podesite noge pećnice

Podešavanje nogu pećnice

Vibracije tokom upotrebe mogu uzrokovati pomicanje posuda za kuhanje. Ova opasna situacija se može izbjeći ako je proizvod nivelisan i uravnotežen.

Radi vlastite sigurnosti provjerite da je proizvod nivelisan tako što ćete podesiti četiri nožice na dnu okretanjem lijevo ili desno i poravnati u ravni s radom vrh.

Konačna provjera

1. Ponovo priključite proizvod na električnu mrežu.
2. Provjerite funkcije.

5 Prva upotreba

Prije nego što počnete da koristite svoj proizvod, preporučuje se da uradite kako je navedeno u odjeljcima u nastavku.

5.1 Početno čišćenje

1. Skinite svu ambalažu.
2. Izvadite sve dodatke iz pećnice isporučene uz proizvod.
3. Uključite proizvod 30 minuta, a zatim ga isključite. Na ovaj način će sagoreti i očistiti se ostaci i slojevi koji su ostali u pećnici tokom proizvodnje.
4. Kada uključite proizvod, odaberite najvišu temperaturu i radnu funkciju na kojoj rade svi grijači u vašem proizvodu.

Pogledajte "Radne funkcije pećnice". U sljedećem odjeljku možete saznati kako koristiti pećnicu.

5. Sačekajte da se pećnica ohladi.
6. Obrišite površine proizvoda vlažnom krpom ili sunđerom i osušite krpom.

Prije upotrebe dodataka;

Očistite dodatke koje izvadite iz pećnice vodom sa deterdžentom i mekanim sunđerom za čišćenje.

BILJESKA: Prilikom prve upotrebe, dim i miris se mogu pojaviti i trajati nekoliko sati. Ovo je normalno i potrebna vam je samo dobra ventilacija da biste to uklonili. Izbjegavajte direktno udisanje dima i mirisa koji se stvaraju.

6 Kako koristiti ploču za kuhanje

6.1 Opće informacije o uporabi ploče za kuhanje

- Suzdržite se od upotrebe neuravnoteženih i lako naginjućih lonaca/ tava na ringli.

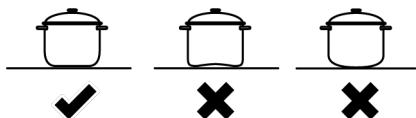

- Suzdržite se od zagrijavanja lonaca/tava i praznih lonaca. Lonci i uređaj se mogu oštetiti.
- Uvijek isključite plamenike ploče za kuhanje nakon svake upotrebe.

- Oštetićete uređaj ako upravljate pločama za kuhanje a da na njima nema postavljenog lonca/tave. Uvijek isključite ploče za kuhanje nakon svake upotrebe.
- Stavite dovoljnu količinu hrane u lonce i šerpe. Tako možete spriječiti izlijevanje hrane iz lonaca/šerpi i to će spriječiti nepotrebno čišćenje.
- Ne stavljajte poklopce lonaca i tiganja na gorionike/zone.
- Postavite lonce centrirajući ih na plamenike/zone. Ako želite postaviti lonac na drugi gorionik/zonu, nemojte ga vući prema željenom plameniku; već ga podignite, a zatim stavite na drugi plamenik.

Preporučene veličine lonaca / šerpi za kuhanje

Prečnik zone za kuhanje - mm	Prečnik lonca - cm
80	8 – 10
145	14 – 16
180	18 - 20
220	22 - 24

6.2 Rad ploča za grijanje

Korištenje grijaćih ploča

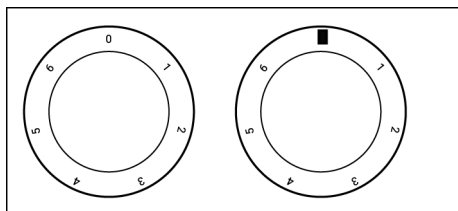

Pločom(ama) za kuhanje možete upravljati pomoću dugmeta za upravljanje pločom za kuhanje. Svako dugme upravlja odgovarajućom pločom za kuhanje. Prema simbolima na upravljačkoj ploči možete zaključiti kojom zonom kuhanja upravlja. Kada je isključena (gornja pozicija), ploča za kuhanje ne radi. Postavite željeni nivo kuhanja poravnavanjem dugmeta na odgovarajuće nivoa.

Ploče za kuhanje mogu imati različite nivoa rada zavisno od modela vašeg uređaja. Možete odabrati odgovarajući nivo za vaš tip kuhanja prema donjoj tabeli.

6 nivoa:

- 1: Podgrijavanje
- 2 – 3: Vrenje, podgrijavanje
- 4 – 6: Pečenje, prženje, kuhanje

Alarmna lampica aktivne ploče za kuhanje

Čim se ploče za kuhanje uključe, na upravljačkoj ploči se uključuje upozoravajuća lampica aktivne ploče za kuhanje. Ova lampica pokazuje da grijača ploča ili barem jedna od njenih grijaćih ploča, ako postoji, radi. Kada je svako dugme na grijaćoj ploči isključeno, lampica se gasi.

Uključivanje ringle:

Za rad ringle koriste se kontrolni gumbi za ploče za kuhanje. Da biste postigli željenu razinu kuhanja, prebacite kontrolni gumb za ploču za kuhanje na željenu razinu.

Isključivanje ringle:

Vratite kontrolni gumb ploče za kuhanje u položaj za isključivanje (gore).

Upotreba ringli

Gumbi za ringle mogu se okretati u oba smjera kako bi se osigurala kontrola topline koja se razlikuje prema razinama.



Ako postoje ploče za kuhanje s funkcijom brzog zagrijavanja, one su označene crvenom tačkom.

7 Korištenje pećnice

7.1 Opće informacije o korištenju pećnice

Ventilator (Razlikuje se u zavisnosti od modela proizvoda. *Možda nije dostupno kod vašeg modela.)

Vaš proizvod ima ventilator za hlađenje. Ventilator za hlađenje se automatski aktivira kad je potrebno i hladi i prednju stranu proizvoda i namještaja. Automatski se deaktivira kada se proces hlađenja završi. Vrući vazduh izlazi preko vrata pećnice. Ne pokrivate ove ventilacione otvore. U suprotnom, pećnica se može pregrijati. Ventilator za hlađenje kontinuirano radi tokom rada pećnice ili nakon isključivanja pećnice (otprilike 20-30 minuta). Ako spremate hranu koristeći programiranje tajmera pećnice, na kraju vremena pripreme ventilator za hlađenje isključuje se sa svim funkcijama. Korisnik ne može odrediti vrijeme rada ventilatora za hlađenje. Uključuje se i isključuje automatski. Ovo nije greška.

Svjetlo u pećnici

Svjetlo pećnice se uključuje kada pećnica počne da peče. U nekim je modelima svjetlo upaljeno tijekom pečenja, dok se u nekim modelima isključuje nakon određenog vremena.

Zaštita od pregrijavanja

Ploče za kuhanje snage veće od 1000W opremljene su zaštitom od pregrijavanja. Zaštita od pregrijavanja smanjuje snagu ploče za kuhanje u sljedećim uvjetima:

- Na ringli nema lonaca ili posuda.
- Na ringli je prazan lonac ili posuda.
- Dno lonca ili posude nije ravno.

7.2 Rad kontrolne jedinice pećnice

Uključivanje pećnice

Kada izaberete radnu funkciju na kojoj želite da spremate hranu pomoću okruglog dugmeta za izbor funkcija i postavite određenu temperaturu pomoću okruglog dugmeta za temperaturu, rena počinje da radi.

Isključivanje pećnice

Renu možete isključiti okretanjem okruglog dugmeta za izbor funkcija i okruglog dugmeta za temperature u položaj „isključeno“ (gore).

Izbor temperature i funkcije rada rerne

Možete spremati hranu tako što ćete izvršiti manuelnu kontrolu (pod vašom kontrolom) odabirom temperature i radne funkcije specifične za vašu hranu.



1. Izaberite radnu funkciju na kojoj želite da spremate hranu pomoću okruglog dugmeta za izbor funkcija.

2. Podesite temperaturu na kojoj želite da spremate hranu pomoću okruglog dugmeta za temperaturu.
 - ⇒ Vaša rerna će odmah početi da radi na izabranoj funkciji i temperaturi, a lampica za termostat će se upaliti. Kada temperatura unutar pećnice dosegne željenu temperaturu, lampica

termostata će se ugasi. Pećnica se neće sama isključiti nakon procesa pečenja. Morate sami kontrolirati pečenje i isključiti pećnicu. Kad je spremanje hrane završeno, isključite rernu okretanjem okruglog dugmeta za odabir funkcije i okruglog dugmeta za temperaturu u položaj „isključeno“ (gore).

8 Opće informacije o pečenju

U ovom odjeljku možete pronaći savjete za pripremu i kuhanje hrane.

Pored toga, u ovom odjeljku su opisana neka od jela koje su testirali proizvođači i najprikladnija podešavanja za ta jela. Takođe su navedena odgovarajuće postavke pećnice za dodatke za ta jela.

8.1 Opće informacije o pečenju u pećnici

- Dok otvarate vrata pećnice za vrijeme ili nakon pečenja, može se pojaviti vruća para. Para može izazvati opekotine na rukama, licu i/ili očima. Kada otvarate vrata pećnice, stanite na propisnu udaljenost
- Intenzivna para koja se stvara tokom pečenja može stvoriti kondenzovane kapljice vode na unutrašnjosti i spoljašnjosti pećnice i na gornjim djelovima namještaja zbog temperaturne razlike. To je normalna i fizička pojava.
- Kondenzacija ili vodena para mogu se pojaviti kao znojenje ili kapanje na unutrašnjem staklu pećnice, ovisno o hrani. Ova uobičajena pojava može se desiti prilikom kuvanja. Preporučuje se da koristite vlažnu krpu za čišćenje unutrašnjeg stakla kada se proizvod ohladi nakon kuvanja.
- Temperatura i vrijeme spremanja hrane predviđeni za izvjesno jelo mogu varirati u zavisnosti od recepta i količine. Iz tog razloga, ove vrijednosti su date okvirno.

- Uvijek izvadite neupotrijebljene dodatke iz pećnice prije nego što započnete sa spremanjem hrane. Dodaci koji ostanu u pećnici mogu osujetiti pripremu vašeg jela korišćenjem predviđenih vrijednosti.
- Za jela koja pripremate prema sopstvenom receptu, možete kao referencu koristiti slična jela data u tabelama za pripremu.
- Korištenje isporučenog pribora osigurava najbolje performanse kuhanja. Uvijek se pridržavajte informacija proizvođača za vanjsko posuđe koje ćete koristiti.
- Izrežite papir za pečenje koji ćete koristiti u pripremi na veličinu koja je odgovarajuća za posudu u kojoj planirate da spremate jelo. Papir za pečenje koji prelazi preko posude može stvoriti opasnost od požara i uticati na kvalitet vaše pečene hrane. Koristite papir za pečenje koji ćete koristiti u navedenom temperaturnom opsegu.
- Za dobar učinak pečenja stavite hranu na preporučenu ispravnu policu. Ne mijenjajte položaj police tokom pečenja.

8.1.1 Peciva i hrana iz pećnice

Opće informacije

- Da biste postigli dobre performanse pečenja preporučujemo uporabu dodatka proizvoda. Ako koristite spoljni pribor za spremanje jela, preferirajte tamno posuđe koje se ne lijepi i koje je otporno na toplinu.
- Ako je u tabeli za pečenje preporučeno prethodno zagrijavanje, obavezno stavite hranu u pećnicu nakon prethodnog zagrijavanja

- Ako ćete kuhati koristeći posuđe na žičanom roštilju, postavite ga na sredinu žičane rešetke, a ne blizu stražnjeg zida.
- Svi materijali koji se koriste u pravljenju peciva treba da budu svježiji i na sobnoj temperaturi.
- Status kuhanja hrane može varirati ovisno o količini hrane i veličini posuđa.
- Metalni, keramički i stakleni kalupi produžavaju vrijeme kuhanja, a donje površine peciva ne porumene ravnomjerno.
- Ako koristite papir za pečenje, na donjoj površini namirnice može se primijetiti malo porumenjelosti. U ovoj situaciji, možda ćete morati produžiti period kuhanja za otprilike 10 minuta.
- Vrijednosti navedene u tabelama za spremanje određene su nakon rezultata testiranja izvršenih u našim laboratorijama. Vrijednosti koje budu vama odgovarale mogu se razlikovati od tih vrijednosti.
- Stavite hranu na odgovarajuću policu koja se preporučuje u tabeli za spremanje hrane. Polica br. 1. je donja polica pećnice.
- Kuhajte preporučena jela prema tablici za spremanje hrane sa jednim plehom.

Savjeti za pečenje kolača

- Ako je kolač previše suv, povećajte temperaturu za 10 °C i skratite vrijeme pečenja.

- Ako je kolač nepečen, koristite malu količinu tečnosti ili smanjite temperaturu za 10 °C.
- Ako je vrh kolača izgoreo, stavite ga na donju policu, smanjite temperaturu i produžite vrijeme pečenja.
- Ako je unutarnjost torte dobro pečena, a spolja je ljepljiva, koristite manje tečnosti, smanjite temperaturu i produžite vrijeme kuhanja.

Savjeti za pecivo

- Ako je pecivo previše suvo, povećajte temperaturu za 10 °C i skratite vrijeme pečenja. Navlažite slojeve testa prelivom od mlijeka, ulja, jaja i jogurta.
- Ako se pecivo predugo peče, vodite računa da debljina tijesta ne bude veća od dubine pleha.
- Ako površina peciva potamni, ali donji dio nije pečen, vodite računa da ne koristite veliku količinu preliva na dnu peciva. Probajte da ravnomjerno rasporedite preliv između slojeva tijesta i preko površine peciva da biste postigli ravnomjerno tamnu boju peciva.
- Pecite tijesto u položaju i na temperaturi prema vrijednostima datim u tabeli. Ako dno i dalje nije dovoljno tamno, stavite ga na donju policu prilikom narednog pečenja.

Tablica za spremanje peciva i hrane za pečenje

Hrana	Dodaci koje možete koristiti	Radna funkcija	Pozicija police	Temperatura (°C)	Vrijeme pečenja (minimalno) (okvirno)
Torta na poslužavniku	Standardni pleh *	Gornji i donji grijač	3	180	30 ... 45
Kolač u kalupu	Kalup za kolače na žičanom grilu **	Gornji i donji grijač	2	180	30 ... 50
Sitni kolači	Standardni pleh *	Gornji i donji grijač	3	160	25 ... 35
Sitni kolači	Standardni pleh *	Gornji i donji grijač + ventilator	2	150	20 ... 30
Biskvit torta	Okrugli kalup za kolače, prečnika 26 cm sa stezaljkom na žičanom grilu **	Gornji i donji grijač	2	160	30 ... 45

Hrana	Dodaci koje možete koristiti	Radna funkcija	Pozicija polica	Temperatura (°C)	Vrijeme pečenja (minimalno) (okvirno)
Biskvit torta	Okrugli kalup za kolače, prečnika 26 cm sa stezaljkom na žičanom grilu **	Gornji i donji grijač + ventilator	2	160	20 ... 30
Keksići	Pleh za tijesta *	Gornji i donji grijač	3	170	25 ... 40
Peciva	Standardni pleh *	Gornji i donji grijač + ventilator	2	200	30 ... 40
Lepinja	Standardni pleh *	Gornji i donji grijač	2	200	20 ... 35
Cijeli hleb	Standardni pleh *	Gornji i donji grijač	3	200	30 ... 45
Lazanje	Staklena/metalna pravougaona posuda na žičanom grilu **	Gornji i donji grijač	2 ili 3	200	30 ... 45
Pita od jabuka	Okrugli crni metalni kalup, prečnika 20 cm na žičanom grilu **	Gornji i donji grijač	2	180	60 ... 75
Pizza	Standardni pleh *	Gornji i donji grijač	2	220	10 ... 25

Prethodno zagrijavanje se preporučuje za svu hranu.

*Ovi dodaci možda nisu uključeni u vaš proizvod.

**Ovi dodaci nisu uključeni u vaš proizvod. Oni su komercijalno dostupni dodaci.

8.1.2 Meso, riba i meso od peradi

Ključne tačke o grilovanju

- Pečenje cijelog pileta, ćurke i velikih komada mesa sa dresingom poput limunovog soka i crnog bibera koji se stavlja prije pečenja, poboljšaće performanse pečenja
- Potrebno je 15 do 30 minuta duže za pečenje mesa sa kostima u odnosu na pečenje iste količine mesa bez kostiju.

- Za svaki centimetar debljine mesa je potrebno približno 4 do 5 minuta pečenja.
- Nakon isteka vremena pečenja, ostavite meso u pećnici oko 10 minuta. Sokovi se bolje raspoređuju kroz meso i ne cure kada se meso siječe.
- Ribu postavite u sredinu žičane police na dnu u vatrostalnoj posudi.
- Kuhajte preporučena jela prema tablici za spremanje hrane sa jednim plehom.

Stol za spremanje mesa, ribe i peradi

Hrana	Dodaci koje možete koristiti	Radna funkcija	Pozicija police	Temperatura (°C)	Vrijeme pečenja (minimalno) (okvirno)
Stek (cijeli) / Prženi (1 kg)	Standardni pleh *	Gornji i donji grijač + ventilator	3	15 min. 250/ maks, nakon 180 ... 190	60 ... 80
Janjeća plečka (1,5-2 kg)	Standardni pleh *	Gornji i donji grijač + ventilator	3	15 min. 250/ maks, nakon 170	110 ... 120
Pečena piletina (1,8-2 kg)	Žičani gril * Stavite jednu posudu na donju policu.	Gornji i donji grijač + ventilator	2	15 min. 250/ maks, nakon 190	60 ... 80
Ćurka (5,5 kg)	Standardni pleh *	Gornji i donji grijač + ventilator	1	25 min. 250/ maks, nakon 180 ... 190	150 ... 210
Riba	Žičani gril * Stavite jednu posudu na donju policu.	Gornji i donji grijač + ventilator	3	200	20 ... 30

Prethodno zagrijavanje se preporučuje za svu hranu.

*Ovi dodaci možda nisu uključeni u vaš proizvod.

**Ovi dodaci nisu uključeni u vaš proizvod. Oni su komercijalno dostupni dodaci.

8.1.3 Gril

Kada grilujete crveno meso, ribu ili perad, ona brzo potamni, ima lijepu koricu i ne isušuje se. Fileti mesa, komadići mesa i kobasice su naročito pogodni za grilovanje, kao i povrće sa visokim sadržajem vode poput paradajza i crnog luka.

Opće informacije

- **Za vrijeme grilovanja zatvorite vrata pećnice. Nikada ne grilujte sa otvorenim vratima pećnice.**

Ključne tačke grila

- Pripremite hranu slične debljine i težine što je više moguće za grilovanje.

- Rasporedite komade koji će se grilovati na žičanu policu ili u pleh za pečenje sa žičanom policom tako da površina hrane nije veća od površine grijača.
- U zavisnosti od debljine komada za gril, vremena pripreme data u tabeli mogu varirati.
- Ubacite žičanu policu ili pleh za grilovanje na željeni nivo u pećnici. Ako grilujete na žičanoj polici, ubacite pleh na nižu visinu kako bi prikupljao masnoću. Pleh koji ćete ubaciti trebalo bi da bude veličine tako da pokriva cjelokupnu površinu grila. Takav pleh možda nije priložen uz proizvod. Dodajte malo vode u pleh zbog lakšeg čišćenja.

Tabela za gril

Hrana	Dodaci koje možete koristiti	Pozicija polica	Temperatura (°C)	Vrijeme pečenja (minimalno) (okvirno)
Riba	Žičani gril	4 - 5	250	20 ... 25
Piletina u komadima	Žičani gril	4 - 5	250	25 ... 35
Ćufte (teletina) - 12 količina	Žičani gril	4	250	20 ... 30
Janjeći kotleti	Žičani gril	4 - 5	250	20 ... 25
Odrezak - (meso sjeckano na kockice)	Žičani gril	4 - 5	250	25 ... 30
Teleći kotleti	Žičani gril	4 - 5	250	25 ... 30
Gratinirano povrće	Žičani gril	4 - 5	220	20 ... 30
Tostirani hleb	Žičani gril	4	250	1 ... 4

Preporučuje se prethodno zagrijavanje 5 minuta za svu hranu koja se griluje.

Komade hrane okrenite nakon 1/2 ukupnog vremena spremanja hrane.

Niski gril + ventilator

Hrana	Dodaci koje možete koristiti	Radna funkcija	Pozicija polica	Temperatura (°C)	Vrijeme pečenja (minimalno) (okvirno)
Riba	Žičani gril	Niski gril + ventilator	4	200	30 ... 35
Piletina u komadima	Žičani gril	Niski gril + ventilator	4	250	25 ... 35
Ćufte (teletina) - 12 količina	Žičani gril	Niski gril + ventilator	4	250	30 ... 40
Stek (cijeli) / Prženi (1 kg)	Žičani gril - Stavite jednu posudu na donju policu.	Niski gril + ventilator	3	15 min. 250, nakon 180 ... 190	90 ... 110

Nemojte prethodno zagrijavati posude preporučeno u ovoj tabeli za roštilj.

8.1.4 Testna jela

- Jela u ovoj tabeli pripremljena su u skladu sa standardom EN 60350-1 kako bi se olakšalo testiranje proizvoda za kontrolne ustanove.

- Kuhajte preporučena jela prema tablici za spremanje hrane sa jednim plehom.

Tabela načina kuhanja testnih obroka

Hrana	Dodaci koje možete koristiti	Radna funkcija	Pozicija polica	Temperatura (°C)	Vrijeme pečenja (minimalno) (okvirno)
Pecivo (slatki kolačić)	Standardni pleh *	Gornji i donji grijač	3	140	20 ... 30
Sitni kolači	Standardni pleh *	Gornji i donji grijač	3	160	25 ... 35
Sitni kolači	Standardni pleh *	Gornji i donji grijač + ventilator	2	150	20 ... 30

Hrana	Dodaci koje možete koristiti	Radna funkcija	Pozicija polica	Temperatura (°C)	Vrijeme pečenja (minimalno) (okvirno)
Biskvit torta	Okrugli kalup za kolače, prečnika 26 cm sa stezaljkom na žičanom grilu **	Gornji i donji grijač	2	160	30 ... 45
Biskvit torta	Okrugli kalup za kolače, prečnika 26 cm sa stezaljkom na žičanom grilu **	Gornji i donji grijač + ventilator	2	160	20 ... 30
Pita od jabuka	Okrugli crni metalni kalup, prečnika 20 cm na žičanom grilu **	Gornji i donji grijač	2	180	60 ... 75

Prethodno zagrijavanje se preporučuje za svu hranu.

*Ovi dodaci možda nisu uključeni u vaš proizvod.

**Ovi dodaci nisu uključeni u vaš proizvod. Oni su komercijalno dostupni dodaci.

Gril

Hrana	Dodaci koje možete koristiti	Pozicija polica	Temperatura (°C)	Vrijeme pečenja (minimalno) (okvirno)
Ćufte (teletina) - 12 količina	Žičani gril	4	250	20 ... 30
Tostirani hleb	Žičani gril	4	250	1 ... 4

Preporučuje se prethodno zagrijavanje 5 minuta za svu hranu koja se griluje.

Komade hrane okrenite nakon 1/2 ukupnog vremena spremanja hrane.

9 Održavanje i čišćenje

9.1 Opće informacije o čišćenju

Opšta upozorenja

- Sačekajte da se uređaj ohladi prije čišćenja. Vruće površine mogu izazvati opekotine!
- Nemojte nanositi deterdžente direktno na vruće površine. Ovo može izazvati trajne mrlje.
- Detaljno očistite i osušite uređaj nakon svake upotrebe. Na taj način ćete lakše ukloniti ostatke hrane, čime izbjegavate da ti ostaci izgore tokom sljedeće upotrebe uređaja. Time se produžava vijek trajanja uređaja i smanjuju problemi sa kojima se često suočavaju korisnici.
- Nemojte koristiti sredstva za čišćenje na paru za čišćenje.
- Neki deterdženti ili sredstva za čišćenje mogu izazvati oštećenja površine. Neprikladna sredstva za čišćenje su: izbjeljivač, proizvodi za čišćenje koji sadrže amonijak, kiselinu ili hlorid, proizvodi za čišćenje parom, sredstva za uklanjanje kamenca, sredstva za uklanjanje mrlja i rđe, abrazivna sredstva za čišćenje (kreme za čišćenje, prašak za ribanje, krema za ribanje, abrazivno sredstvo i pribor za struganje, žica, spužve, krpe za čišćenje koje upijaju prljavštinu i ostatke deterdženta).
- Za čišćenje nakon svake upotrebe nije potreban poseban materijal za čišćenje. Uređaj očistite deterdžentom za pranje posuđa, toplom vodom i mekom krpom ili sunđerom i osušite suvom krpom.

- Obavezno nakon čišćenja potpuno obrišite preostalu tečnost i odmah očistite hranu isprskanu okolo tijekom pečenja.
- Ne perite nijednu komponentu vašeg uređaja u mašini za pranje sudova osim ako nije drugačije navedeno u korisničkom priručniku.

Za ploče za kuhanje:

- Kisela prljavština kao što su mlijeko, paradajz pasta i ulje mogu da izazovu trajne mrlje na pločama za kuhanje i djelovima zona za kuhanje, očistite sve tečnosti koje se proliju odmah nakon hlađenja ploče za kuhanje tako što ćete je isključiti.

Površine od inoksa i nehrđajuće površine

- Ne koristite sredstva za čišćenje koja sadrže kiselinu ili hlor za čišćenje površina od nehrđajućeg čelika ili inoksa i ručica.
- Površina od nehrđajućeg inoksa može vremenom promijeniti boju. Ovo je normalno. Nakon svakog rada, očistite deterdžentom pogodnim za nehrđajuću površinu ili površinu od inoksa.
- Koristite meku krpu sa tečnim deterdžentom (neabrazivnim) pogodnim za čišćenje površina od inoksa, pri čemu treba da obratite pažnju da brišete samo u jednom pravcu.
- Odstranite mrlje od kamenca, ulja, škroba i proteina na staklenim površinama i površinama od inoksa bez odlaganja. Mrlje mogu zarđati nakon duže vremena.
- Sredstva za čišćenje poprskana/nanešena na površinu treba odmah očistiti. Abrazivna sredstva za čišćenje ostavljena na površini uzrokuju pojavu bijelih mrlja na površini.

Emajlirane površine

- Da biste očistili prostor predviđen za spremanje hrane, pećnica se mora ohladiti. Čišćenje vrućih površina izazvaće i opasnost od požara i oštećenja emajlirane površine.

- Nakon upotrebe, površine od emajla očistite deterdžentom za pranje posuđa, toplom vodom i mekom krpom ili sunderom i osušite suvom krpom.
- Ako vaš proizvod ima funkciju lakog čišćenja parom, možete izvršiti lako čišćenje parom za netvrdokornu trenutnu nečistoću. (Pogledajte "Jednostavno paročišćenje [▶ 67]".)

Katalitičke površine

- Bočne strane u prostoru za spremanje hrane mogu biti prekrivene samo emajliranim ili katalitičkim zidovima. Navedeno zavisi od modela.
- Katalitički zidovi imaju laganu mat i poroznu površinu. Katalitički zidovi rerne se ne smiju čistiti.
- Katalitičke površine apsorbuju ulje zahvaljujući svojoj poroznoj strukturi i počinju sjajiti kada je površina zasićena uljem, u tom slučaju preporučuje se zamjena djelova.

Staklene površine

- Pri čišćenju staklenih površina ne koristite strugače od tvrdog metala i abrazivne materijale za čišćenje. Isti mogu oštetiti staklenu površinu.
- Proizvod očistite deterdžentom za pranje posuđa, toplom vodom i mekom krpom od sitnih vlakana koja je predviđena za čišćenje staklenih površina i osušite suvom krpom od sitnih vlakana.
- Ako posle čišćenja ima ostatka deterdženta, obrišite hladnom vodom i osušite čistom i suvom krpom od sitnih vlakana. Sljedeći put preostali deterdžent može oštetiti staklenu površinu.
- Ni pod kojim uslovima ostatke osušene na staklenoj površini ne treba ljuštiti nazubljenim noževima, žičanom vunom ili sličnim alatima za grebanje.
- Mrlje od kalcijuma (žute mrlje) možete ukloniti sa staklene površine komercijalno dostupnim sredstvom za uklanjanje kamenca, sredstvom za uklanjanje kamenca poput sirćeta ili limunovog soka.

- Ako je površina jako zaprljana, nanesite sredstvo za čišćenje na mrlju sunderom i sačekajte duže vremena da isto adekvatno odreaguje. Zatim očistite staklenu površinu vlažnom krpom.
- Promjene boje i mrlje na staklenoj površini normalna su pojava i ne predstavljaju grešku.

Plastični djelovi i obojene površine

- Očistite plastične djelove i obojene površine deterdžentom za pranje posuđa, toplom vodom i mekom krpom ili sunderom i osušite suvom krpom.
- Ne koristite strugače od tvrdog metala i abrazivna sredstva za čišćenje. Oni mogu oštetiti površine.
- Uvjerite se da spojevi komponenti proizvoda ne budu ostavljeni vlažni i sa deterdžentom. U suprotnom može doći do korozije na ovim spojevima.

9.2 Pribor za čišćenje

Ne stavljajte dodatke proizvoda u mašinu za pranje sudova osim ako nije drugačije navedeno u korisničkom priručniku.

9.3 Čišćenje ploče za kuhanje

Električne ploče za kuhanje

1. Isključite ringle i pričekajte dok se ne ohlade.
2. Po potrebi očistite ringle sredstvom za čišćenje (sredstva za čišćenje/omekšivače možete nabaviti u specijaliziranim prodavaonicama).
3. Zagrijavajte samo nekoliko minuta nakon čišćenja kako bi se njihov gornji dio osušio.
4. Redovno nanosite tanki sloj mašinskog ulja na gornju površinu ringle kako biste je zaštitili.

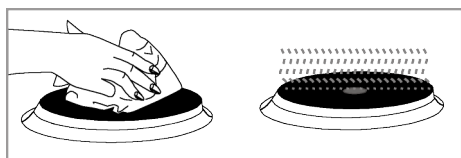

9.4 Čišćenje kontrolne table

- Prilikom čišćenja ploča s kontrolnim okruglim dugmadima, obrišite tablu i dugmad vlažnom mekom krpom i osušite suvom krpom. Ne uklanjajte tipke i zaptivke ispod da biste očistili kontrolnu tablu. Na taj način možete oštetiti kontrolnu tablu i dugmad.
- Prilikom čišćenja inoksa panela s kontrolnim dugmadima, nemojte koristiti sredstva za čišćenje površina od inoksa oko dugmadi. Indikatori oko dugmeta se mogu izbrisati.
- Očistite kontrolnu tablu osjetljivu na dodir vlažnom mekom krpom i osušite suvom krpom. Ako vaš proizvod ima funkciju zaključavanja tipki, postavite zaključavanje tipki prije čišćenja kontrolne table. Ako postupite drugačije, tipke možete nepropisno odabrati.

9.5 Čišćenje unutrašnjosti rerne (površina za spremanje hrane)

Slijedite korake čišćenja opisane u odjeljku „Opšte informacije o čišćenju“ prema tipovima površine u vašoj pećnici.

Čišćenje stranica rerne

Bočne strane u prostoru za spremanje hrane mogu biti prekrivene samo emajliranim ili katalitičkim zidovima. Navedeno zavisi od modela. Ako model ima katalitičku stranicu, pogledajte informacije u odjeljku „Katalitički zidovi“. Ako je vaš proizvod model sa žičanim policama, uklonite žičane police prije čišćenja bočnih zidova. Zatim završite čišćenje kako je opisano u odjeljku „Opšte informacije o čišćenju“ prema vrsti bočnog zida.

Da biste uklonili bočne žičane police:

1. Uklonite prednji dio žičane police povlačenjem na bočni zid u suprotnom smjeru.
2. Povucite žičanu policu prema sebi da biste je potpuno skinuli.

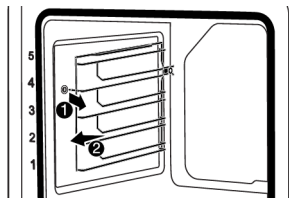

3. Da biste ponovo postavili police, obavite iste korake kao tokom skidanja, ali obrnutim redoslijedom.

9.6 Jednostavno paročišćenje

Ovo omogućava čišćenje prljavštine (koja nije tvrdokorna) koja je omekšana parom u pećnici i kapljicama vode koje se lako kondenzuju na unutarnjim površinama pećnice.

1. Izvadite sve dodatke iz pećnice.
2. Sipajte 500 ml vode u pleh i stavite pleh na 2. nivo police u pećnici.

i Uzdržite se od destilovane ili filtrirane vode. Koristite samo gotovu vodu.

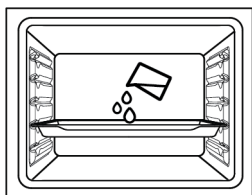

3. Podesite pećnicu na radni režim jednostavnog paročišćenja i uključite je na 100°C tokom 15 minuta.

Odmah otvorite vrata i obrišite unutarnjost pećnice mokrim sunđerom ili krpom. Para će se osloboditi prilikom otvaranja vrata.

Ovo može stvoriti rizik od opekotina. Budite oprezni prilikom otvaranja vrata.

U slučaju tvrdokornih mrlja, proizvod očistite deterdžentom za pranje posuđa, toplom vodom i mekom krpom ili sunđerom i osušite suvom krpom.

i U funkciji lakog paročišćenja, očekuje se da dodana voda ispari i kondenzira se na unutarnjoj strani pećnice i na vratima pećnice kako bi se omekšala lagana prljavština nastala u vašoj pećnici. Kondenzat koji se stvori na vratima pećnice može prsnuti okolo kada se vrata pećnice otvore. Čim otvorite vrata pećnice, obrišite kondenzaciju.

(Razlikuje se u zavisnosti od modela proizvoda. *Možda nije dostupno kod vašeg modela.) Nakon kondenzacije unutar pećnice, može se pojaviti lokvica ili vlaga u žlebu spremnika na dnu pećnice. Nakon upotrebe, očistite ovaj žleb vlažnom krpom a zatim posušite.

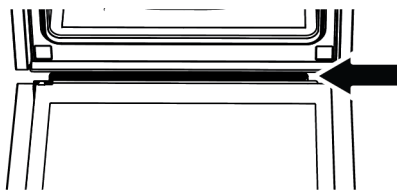

9.7 Čišćenje vrata pećnice

Možete da skinete vrata i staklo rerne da biste ih očistili. Kako ukloniti vrata i staklo objašnjeno je u odjeljcima „**Skidanje vrata pećnice**“ i „**Skidanje unutarnjeg stakla na vratima pećnice**“. Nakon što skinete unutrašnje staklo na vratima, očistite ga sredstvom za pranje posuđa, toplom vodom i mekom krpom ili sunđerom i osušite suvom krpom. Da biste uklonili ostatke kamenca koji se mogu formirati na staklu pećnice, obrišite staklo sirčetom i isperite.

Skidanje vrata rerne

1. Otvorite vrata pećnice.
2. Otvorite klipse na šarkama sa desne i lijeve strane na vratima tako što ćete ih gurnuti nadolje kao što je prikazano na slici.
3. Tipovi šarki su (A), (B), (C) u zavisnosti od modela proizvoda. Sljedeće slike pokazuju kako otvoriti svaku vrstu šarke.

4. (A) tip šarke je dostupan u normalnim tipovima vrata.

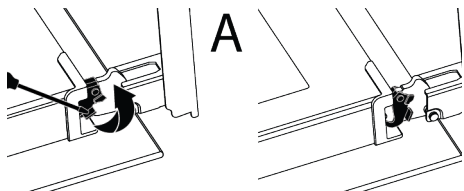

5. B) tip šarke je dostupan u tipovima vrata sa mekim zatvaranjem.

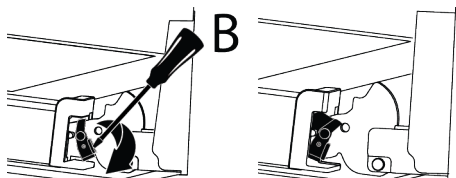

6. Šarke tipa (C) su dostupne u tipovima vrata sa mekim otvaranjem/zatvaranjem.

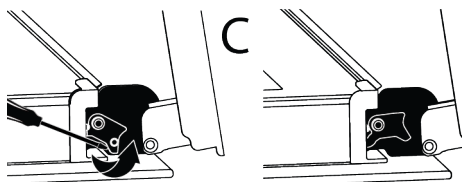

7. Postavite vrata rerne u poluzatvoren položaj.

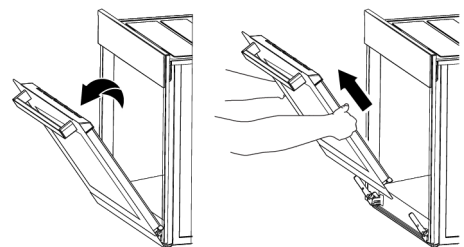

8. Skinite vrata tako što ćete ih izvući naviše da biste ih oslobodili iz lijeve i desne šarke.

i Kada vraćate vrata, obavite iste korake kao tokom skidanja, ali obrnutim redoslijedom. Ne zaboravite da zatvorite klipse na šarkama kada vratite vrata.

9.8 Skidanje unutarnjeg stakla sa vrata pećnice

Unutarnje staklo na vratima uređaja može se skinuti za potrebe čišćenja.

1. Otvorite vrata pećnice.

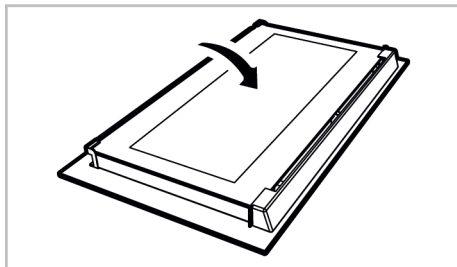

2. Povucite ka sebi i skinite plastični dio ugrađen u gornji dio vrata rerne.

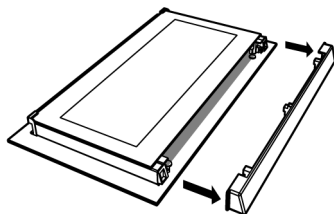

3. Kao što je prikazano na slici, malo podignite staklenu ploču s unutarnje strane (1) prema „A“ a zatim je izvadite povlačenjem prema „B“.

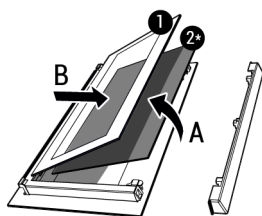

- 1 Staklena ploča sa unutarnje strane 2* Unutarnje staklo (možda nije dostupno kod vašeg proizvoda)
4. Ako vaš proizvod ima unutarnje staklo (2), ponovite isti postupak da biste ga skinuli (2).
5. Prvi korak za vraćanje vrata u probitno stanje je ponovno postavljanje unutarnjeg stakla (2). Postavite zakošeni ugao staklene ploče tako da

nalegne u zakošeni ugao na plastičnom prerezu. (Ako vaš proizvod ima unutrašnje staklo). Unutrašnje staklo (2) mora biti pričvršćeno na plastični prerez najbliži staklenoj ploči s unutarnje strane (1).

- Prilikom ponovnog postavljanja staklene ploče s unutarnje strane (1) provjerite da li štampana strana stakla leži licem prema unutarnjem staklu. Od ključnog je značaja da donji uglovi staklene ploče s unutarnje strane (1) nalegnu u donje plastične proreze.
- Gurnite plastični dio prema okviru dok ne čujete zvuk „klik“.

9.9 Čišćenje sijalice u pećnici

U slučaju da se staklena površina sijalice u rerni postane zaprlja; očistite je deterdžentom za pranje posuđa, toplom vodom i mekom krpom ili sunđerom i osušite suvom krpom. U slučaju kvara sijalice u rerni, možete zamijeniti sijalicu prema postupku opisanom u sljedećem odjeljku.

Zamjena sijalice u rerni

Opće informacije

- Prije mijenjanja sijalice provjerite da li je uređaj isključen sa napajanja električnom energijom i da li se ohladio, kako biste izbjegli rizik od strujnog udara. Vruće površine mogu izazvati opekotine!
- Ovu pećnicu napaja sijalica sa žarnom niti snage manje od 40 W, manje od 60 mm visine, manje od 30 mm u prečniku ili halogena lampa sa utičnicom G9 snage manje od 60 W. Sijalice su pogodne za rad na temperaturama iznad 300 °C. Sijalice za pećnice su dostupne kod ovlašćenih servisa ili licenciranih tehničara. Ovaj proizvod sadrži sijalicu energetske klase G.
- Položaj sijalice može se razlikovati od položaja prikazanog na slici.

- Sijalica koja se koristi u ovom proizvodu nije adekvatna za upotrebu u domaćinstvu za osvjetljavanje prostorija. Svrha ove sijalice je da pomogne korisniku da vidi prehrambene proizvode.
- Sijalice koje se koriste u ovom proizvodu podnose ekstremne fizičke uslove kao što su temperature iznad 50 °C.

Ako vaša rerna ima okruglu sijalicu:

- isključite uređaj iz struje.
- Uklonite zaštitno staklo okrećući ga u smjeru suprotnom od kazaljke na satu.

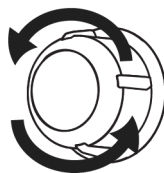

- Ako je sijalica vaše rerne tipa (A) prikazana na donjoj slici, okrenite sijalicu rerne kao što je prikazano na slici i zamijenite je novom. Ako je model tipa (B), izvucite je kao što je prikazano na slici i zamijenite je novom.

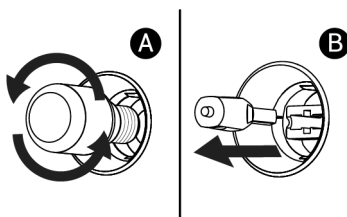

- Vratite zaštitno staklo.

Ako vaša rerna ima kockastu sijalicu,

- isključite uređaj iz struje.
- Uklonite žičane police kao što je opisano.

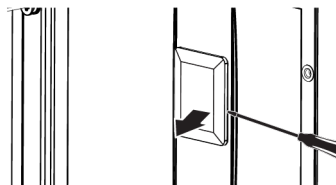

3. Šrafciгерom podignite zaštitno staklo sijalice. Prvo uklonite vijak, ako postoji vijak na kvadratnoj lampi u vašem proizvodu.
4. Ako je sijalica vaše rene tipa (A) prikazana na donjoj slici, okrenite sijalicu rene kao što je prikazano na slici i zamijenite je novom. Ako je model tipa (B), izvucite je kao što je prikazano na slici i zamijenite je novom.

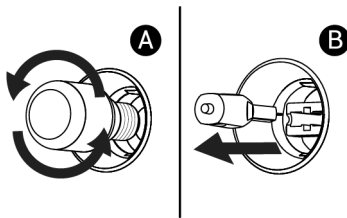

5. Vratite zaštitno staklo, a zatim vratite žičane police.

10 Rješavanje problema

Ako problem postoji i nakon što postupite u skladu s uputstvima u ovom odjeljku, obratite se svom dobavljaču ili ovlaštenom servisu. Nikada ne pokušavajte sami da popravite svoj uređaj.

Para se emituje dok pećnica radi.

- Normalno je da se stvara para tokom rada. >>> Ovo nije greška.

Tokom kuhanja pojavljuju se kapljice vode

- Para nastala tokom kuhanja kondenzuje se kada dođe u kontakt sa hladnim površinama izvan proizvoda i može formirati kapljice vode. >>> Ovo nije greška.

Zvuci metala se čuju dok se proizvod zagrijeva i hladi.

- Metalni delovi se mogu širiti i proizvoditi zvukove kada se zagriju. >>> Ovo nije greška.

Proizvod ne radi.

- Osigurač je možda neispravan ili pregorio. >>> Provjerite osigurače u razvodnoj kutiji. Promijenite ih ako je potrebno ili ih ponovo uključite.
- Uređaj ne smije biti utaknut u utičnicu (s uzemljenjem). >>> Provjerite je li uređaj uključen u utičnicu.
- (Ako na vašem uređaju postoji tajmer) Tipke na kontrolnoj tabli ne rade. >>> Ako vaš proizvod ima zaključavanje tipki, zaključavanje tipki je možda omogućeno, onemogućite zaključavanje tipki.

Svjetlo na pećnici nije uključeno.

- Sijalica u pećnici je možda neispravna. >>> Zamijenite sijalicu u pećnici.

- Nema struje. >>> Provjerite da li ima napajanja električnom energijom sa mreže i provjerite osigurače u razvodnoj kutiji. Zamijenite osigurače po potrebi ili ih ponovo uključite.

Pećnica ne grije.

- Pećnica možda nije podešena na određenu funkciju za spremanje hrane i/ili temperaturu. >>> Podesite pećnicu na određenu funkciju za spremanje hrane i/ili temperaturu.
- Nema struje. >>> Provjerite da li ima napajanja električnom energijom sa mreže i provjerite osigurače u razvodnoj kutiji. Zamijenite osigurače po potrebi ili ih ponovo uključite.

Ovaj dokument je originalno proizveden i objavljen od strane proizvođača, brenda Indesit, i preuzet je sa njihove zvanične stranice. S obzirom na ovu činjenicu, Tehnoteka ističe da ne preuzima odgovornost za tačnost, celovitost ili pouzdanost informacija, podataka, mišljenja, saveta ili izjava sadržanih u ovom dokumentu.

Napominjemo da Tehnoteka nema ovlašćenje da izvrši bilo kakve izmene ili dopune na ovom dokumentu, stoga nismo odgovorni za eventualne greške, propuste ili netačnosti koje se mogu naći unutar njega. Tehnoteka ne odgovara za štetu nanесenu korisnicima pri upotrebi netačnih podataka. Ukoliko imate dodatna pitanja o proizvodu, ljubazno vas molimo da kontaktirate direktno proizvođača kako biste dobili sve detaljne informacije.

Za najnovije informacije o ceni, dostupnim akcijama i tehničkim karakteristikama proizvoda koji se pominje u ovom dokumentu, molimo posetite našu stranicu klikom na sledeći link:

<https://tehnoteka.rs/p/indesit-elektricni-sporet-i6e5kms-akcija-cena/>