

Uputstvo za upotrebu (EN)

MSI zakrivljeni monitor 32" Rapid VA 321CQF E18



Tehnoteka je online destinacija za upoređivanje cena i karakteristika bele tehnike, potrošačke elektronike i IT uređaja kod trgovinskih lanaca i internet prodavnica u Srbiji. Naša stranica vam omogućava da istražite najnovije informacije, detaljne karakteristike i konkurentne cene proizvoda.

Posetite nas i uživajte u ekskluzivnom iskustvu pametne kupovine klikom na link:

<https://tehnoteka.rs/p/msi-zakrivljeni-monitor-32-rapid-va-321cqf-e18-akcija-cena/>



MAG Series

LCD Monitor

MAG 321CQF E18 (3DE0)

User Guide

Contents

Getting Started	3
Package Contents	3
Installing the Monitor Stand	4
Adjusting the Monitor	5
Monitor Overview	6
Connecting the Monitor to PC	8
OSD Setup.....	9
Navi Key.....	9
Hot Key	9
OSD Menus	10
Gaming	11
Professional	13
Image.....	14
Input Source.....	15
PIP/PBP.....	15
Navi Key.....	16
Settings.....	16
Specifications	18
Preset Display Modes	20
Troubleshooting.....	23
Safety Instructions	24
TÜV Rheinland Certification	26
Regulatory Notices.....	27

Revision

V1.0, 2025/04

Getting Started

This chapter provides you with the information on hardware setup procedures. While connecting devices, be careful in holding the devices and use a grounded wrist strap to avoid static electricity.

Package Contents

Monitor	MAG 321CQF E18
Documentation	Quick Start Guide
Accessories	Stand
	Stand Base
	Power Cord
Cable	DisplayPort Cable



Important

- Contact your place of purchase or local distributor if any of the items is damaged or missing.
- Package contents may vary by country and model.
- The included power cord is exclusively for this monitor and should not be used with other products.

Installing the Monitor Stand

1. Leave the monitor in its protective packaging. Align and gently push the stand bracket towards the monitor groove until it locks in place.
2. Align and gently push the base towards the stand until it locks in place.
3. Make sure the stand assembly is properly installed before setting the monitor upright.

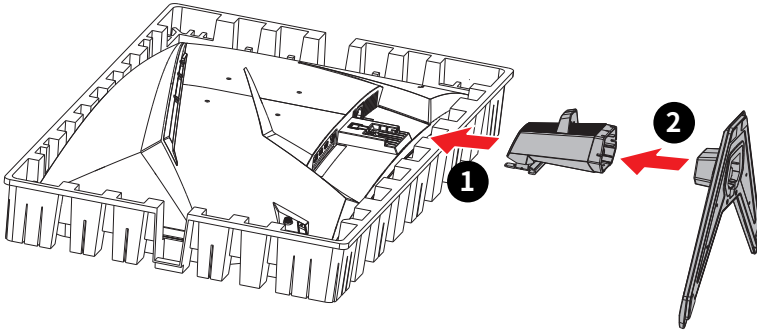

Important

- Place the monitor on a soft, protected surface to avoid scratching the display panel.
- Do not use any sharp objects on the panel.
- This product comes with **NO** protective film to be removed by the user! Any mechanical damages to the product including removal of the polarizing film may affect the warranty!

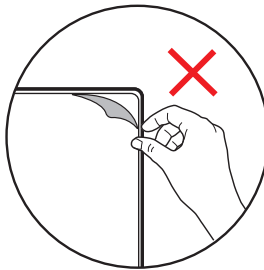

Adjusting the Monitor

This monitor is designed to maximize your viewing comfort with its adjustment capabilities.





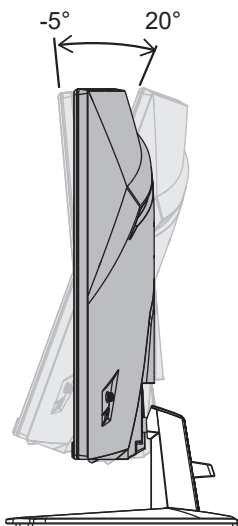

Avoid touching the display panel when adjusting the monitor.

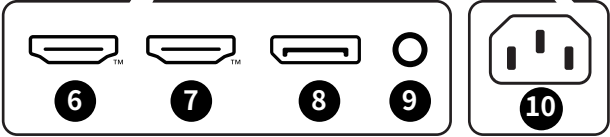
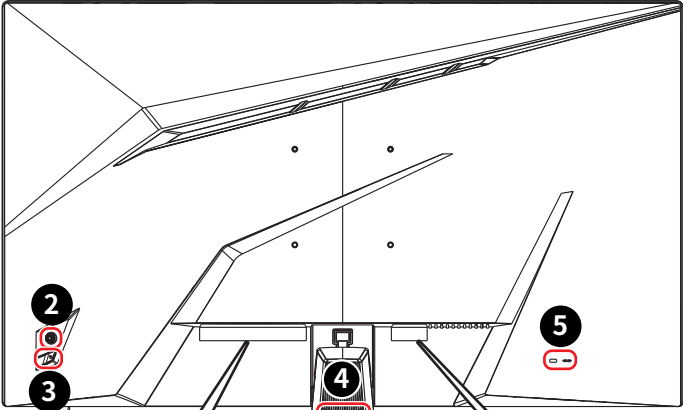
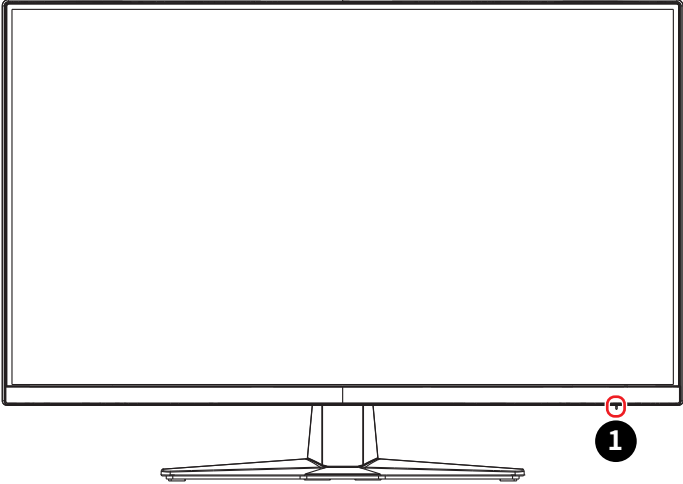

Monitor Overview



1	Power LED Lit in white after the monitor is turned on. If no signal input, the LED will turn into orange. Lit in orange when the monitor is in Stand-by mode.
2	Navi Key
3	Power Button
4	Cable Organizer
5	Kensington Lock
6	HDMI™ Connector  <small>HIGH-DEFINITION MULTIMEDIA INTERFACE</small> Supports HDMI™ CEC, 2560x1440@144Hz as specified in HDMI™ 2.0b.  Important <i>To ensure optimal performance and compatibility, please use only HDMI™ cables certified with the official HDMI™ logo when connecting this monitor. For more information, please visit https://www.hdmi.org/resource/cables.</i>
7	HDMI™ Connector  <small>HIGH-DEFINITION MULTIMEDIA INTERFACE</small> Supports 2560x1440@144Hz as specified in HDMI™ 2.0b.  Important <i>To ensure optimal performance and compatibility, please use only HDMI™ cables certified with the official HDMI™ logo when connecting this monitor. For more information, please visit https://www.hdmi.org/resource/cables.</i>
8	DisplayPort Supports 2560x1440@180Hz as specified in DisplayPort 1.4a.
9	Headphone Jack
10	Power Jack

Connecting the Monitor to PC

1. Turn off your computer.
2. Connect the video cable from the monitor to your computer.
3. Connect the power cord to the monitor power jack. (Figure A)
4. Plug the power cord into the electrical outlet. (Figure B)
5. Turn on the monitor. (Figure C)
6. Power on the computer and the monitor will auto detect the signal source.

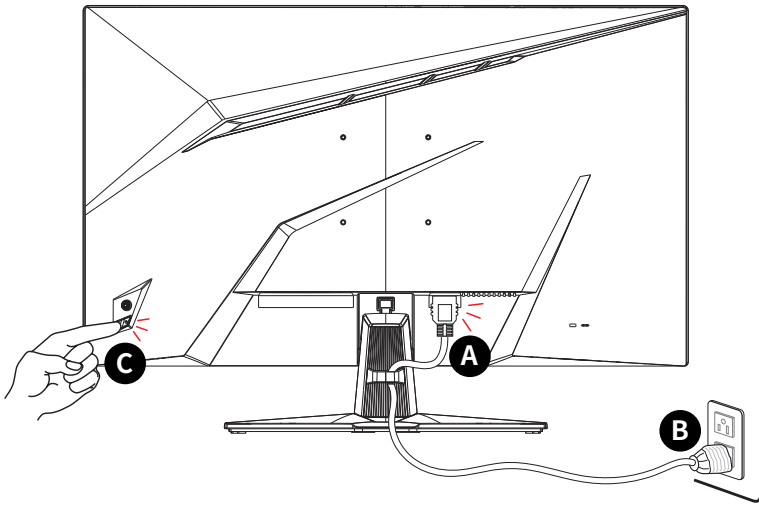

OSD Setup

This chapter provides you with essential information on OSD Setup.



All information is subject to change without prior notice.

Navi Key

The monitor comes with a Navi Key, a multi-directional control that helps navigate the On-Screen Display (OSD) menu.

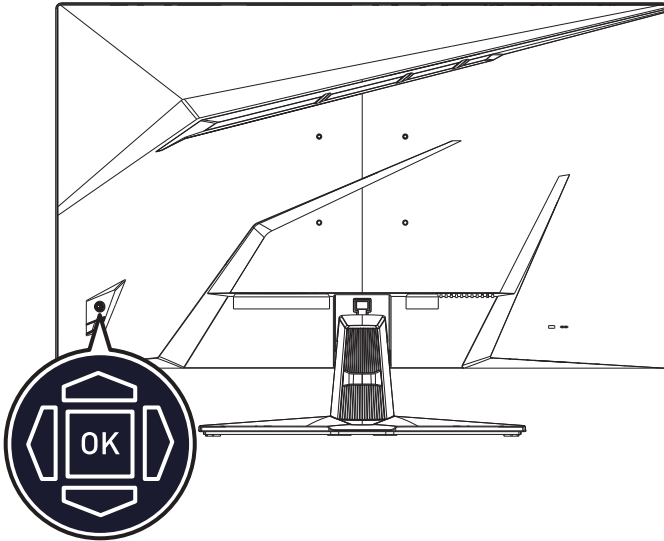

Up/Down/Left/Right:

- selecting function menus and items
- adjusting function values
- entering into/exiting from function menus

Press (OK):

- launching the On-Screen Display (OSD)
- entering submenus
- confirming a selection or setting

Hot Key

- Users may enter into preset function menus by moving the Navi Key up, down, left or right when the OSD menu is inactive.
- Users may customize their own Hot Keys to enter into different function menus.

OSD Menu

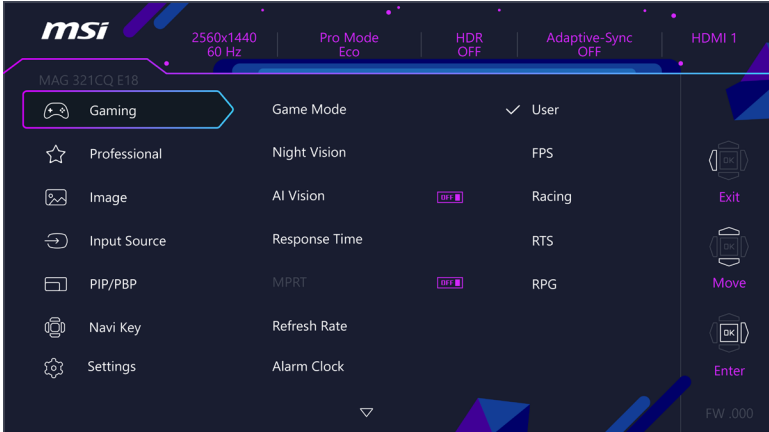

Important

The following settings will be grayed out when HDR signals are received:

- Night Vision
- AI Vision
- MPRT
- Low Blue Light
- HDCR
- Brightness
- Contrast
- Color Temperature
- PIP/PBP
- sRGB

Gaming

1st Level Menu	2nd/3rd Level Menu	Description												
Game Mode	User	<ul style="list-style-type: none"> Use Up or Down Button to select and preview mode effects. Press the OK Button to confirm and apply your mode type. 												
	FPS													
	Racing													
	RTS													
	RPG													
Night Vision	OFF	<ul style="list-style-type: none"> This function optimizes background brightness and is recommended for FPS games. 												
	Normal													
	Strong													
	Strongest													
	A.I.													
AI Vision	OFF	<ul style="list-style-type: none"> AI Vision enhances image quality by optimizing the contrast of images and background brightness. Activating AI Vision will affect: <table border="1" data-bbox="578 703 928 855"> <thead> <tr> <th>Affected Function</th> <th>Function Status</th> </tr> </thead> <tbody> <tr> <td>» Night Vision</td> <td rowspan="4">Unable to select</td> </tr> <tr> <td>» Brightness</td> </tr> <tr> <td>» HDCR</td> </tr> <tr> <td>» MPRT</td> <td>Set to OFF</td> </tr> </tbody> </table> 	Affected Function	Function Status	» Night Vision	Unable to select	» Brightness	» HDCR	» MPRT	Set to OFF				
	Affected Function		Function Status											
» Night Vision	Unable to select													
» Brightness														
» HDCR														
» MPRT		Set to OFF												
ON														
Response Time	Normal	<ul style="list-style-type: none"> Setting to Fastest will reach the shortest response time and help improve blurred images when playing very fast games. 												
	Fast													
	Fastest													
MPRT	OFF	<ul style="list-style-type: none"> MPRT is available when the refresh rate is over 85Hz. Activating MPRT will affect: <table border="1" data-bbox="578 1075 928 1315"> <thead> <tr> <th>Affected Function</th> <th>Function Status</th> </tr> </thead> <tbody> <tr> <td>» Response Time</td> <td rowspan="2">Unable to select</td> </tr> <tr> <td>» Brightness</td> </tr> <tr> <td>» Adaptive-Sync</td> <td rowspan="4">Set to OFF</td> </tr> <tr> <td>» HDCR</td> </tr> <tr> <td>» PIP/PBP</td> </tr> <tr> <td>» AI Vision</td> </tr> <tr> <td>» Screen Size 1:1</td> <td>Set to Auto</td> </tr> </tbody> </table> 	Affected Function	Function Status	» Response Time	Unable to select	» Brightness	» Adaptive-Sync	Set to OFF	» HDCR	» PIP/PBP	» AI Vision	» Screen Size 1:1	Set to Auto
	Affected Function		Function Status											
» Response Time	Unable to select													
» Brightness														
» Adaptive-Sync	Set to OFF													
» HDCR														
» PIP/PBP														
» AI Vision														
» Screen Size 1:1	Set to Auto													
ON														

1st Level Menu	2nd/3rd Level Menu		Description	
Refresh Rate	Location	Left Top	<ul style="list-style-type: none"> Location is adjustable in OSD Menu. Press the OK Button to confirm and apply your Refresh Rate Location. This monitor follows and works at the Operating System's preset Screen Refresh Rate. 	
		Right Top		
		Left Bottom		
		Right Bottom		
		Customize		
OFF				
ON				
Alarm Clock	Location	Left Top	<ul style="list-style-type: none"> After setting the time, press the OK Button to activate the timer. Users have to manually restore their preset Alarm Clock after any AC power loss and reconnection. 	
		Right Top		
		Left Bottom		
		Right Bottom		
		Customize		
	OFF			
	15:00	00:01 ~ 99:59		
30:00				
45:00				
60:00				
Smart Crosshair	Icon	None	<ul style="list-style-type: none"> Through AI algorithm, this function enhances the visibility of in-game crosshair. Users can select the color and position of the crosshair. 	
				
		Color		White
		Red		
		Auto		
		Position		
Reset				

1st Level Menu	2nd/3rd Level Menu	Description								
Adaptive-Sync	OFF	<ul style="list-style-type: none"> Adaptive-Sync prevents screen tearing. When Adaptive-Sync is set to ON, it is mandatory to enable HDMI™ VRR. Activating Adaptive-Sync will affect: <table border="1" data-bbox="578 284 928 411"> <thead> <tr> <th>Affected Function</th> <th>Function Status</th> </tr> </thead> <tbody> <tr> <td>» PIP/PBP</td> <td>Set to OFF</td> </tr> <tr> <td>» MPRT</td> <td></td> </tr> <tr> <td>» Screen Size 1:1</td> <td>Set to Auto</td> </tr> </tbody> </table> 	Affected Function	Function Status	» PIP/PBP	Set to OFF	» MPRT		» Screen Size 1:1	Set to Auto
	Affected Function		Function Status							
» PIP/PBP	Set to OFF									
» MPRT										
» Screen Size 1:1	Set to Auto									
ON										
HDMI™ Console Mode	OFF	<ul style="list-style-type: none"> The Console mode offers broader compatibility with more console devices. The 2160P video resolution will be enabled when HDMI™ Console Mode is turned ON. 								
	ON									

Professional

1st Level Menu	2nd Level Menu	Description						
Pro Mode	Eco	<ul style="list-style-type: none"> Use Up or Down Button to select and preview mode effects. Press the OK Button to confirm and apply your mode type. Activating sRGB will affect: <table border="1" data-bbox="519 802 912 927"> <thead> <tr> <th>Affected Function</th> <th>Function Status</th> </tr> </thead> <tbody> <tr> <td>» Color Temperature</td> <td rowspan="3">Unable to select</td> </tr> <tr> <td>» Low Blue Light</td> </tr> <tr> <td>» Contrast</td> </tr> </tbody> </table> 	Affected Function	Function Status	» Color Temperature	Unable to select	» Low Blue Light	» Contrast
	Affected Function		Function Status					
	» Color Temperature		Unable to select					
	» Low Blue Light							
	» Contrast							
	User							
Anti-Blue								
Movie								
Office								
sRGB								
Low Blue Light	OFF	<ul style="list-style-type: none"> Low Blue Light protects your eyes against blue light. When enabled, Low Blue Light adjusts the screen color temperature to a more yellow glow. When Pro Mode is set to Anti-Blue, it is mandatory to enable Low Blue Light. 						
	ON							
HDCR	OFF	<ul style="list-style-type: none"> HDCR enhances image quality by increasing the contrast of images. Activating HDCR will affect: <table border="1" data-bbox="519 1166 912 1259"> <thead> <tr> <th>Affected Function</th> <th>Function Status</th> </tr> </thead> <tbody> <tr> <td>» Brightness</td> <td>Unable to select</td> </tr> <tr> <td>» MPRT</td> <td>Set to OFF</td> </tr> </tbody> </table> 	Affected Function	Function Status	» Brightness	Unable to select	» MPRT	Set to OFF
	Affected Function		Function Status					
» Brightness	Unable to select							
» MPRT	Set to OFF							
ON								

1st Level Menu	2nd Level Menu	Description												
MPRT	OFF	<ul style="list-style-type: none"> MPRT is available when the refresh rate is over 85Hz. Activating MPRT will affect: <table border="1" data-bbox="519 233 912 475"> <thead> <tr> <th>Affected Function</th> <th>Function Status</th> </tr> </thead> <tbody> <tr> <td>» Response Time</td> <td rowspan="2">Unable to select</td> </tr> <tr> <td>» Brightness</td> </tr> <tr> <td>» Adaptive-Sync</td> <td rowspan="4">Set to OFF</td> </tr> <tr> <td>» HDCR</td> </tr> <tr> <td>» PIP/PBP</td> </tr> <tr> <td>» AI Vision</td> </tr> <tr> <td>» Screen Size 1:1</td> <td>Set to Auto</td> </tr> </tbody> </table> 	Affected Function	Function Status	» Response Time	Unable to select	» Brightness	» Adaptive-Sync	Set to OFF	» HDCR	» PIP/PBP	» AI Vision	» Screen Size 1:1	Set to Auto
	Affected Function		Function Status											
» Response Time	Unable to select													
» Brightness														
» Adaptive-Sync	Set to OFF													
» HDCR														
» PIP/PBP														
» AI Vision														
» Screen Size 1:1	Set to Auto													
	ON													
Image Enhancement	OFF	<ul style="list-style-type: none"> Image Enhancement enhances image edges to improve their acutance. 												
	Weak													
	Medium													
	Strong													
	Strongest													

Image

1st Level Menu	2nd/3rd Level Menu	Description				
Brightness	0-100	<ul style="list-style-type: none"> Properly adjust Brightness according to the surrounding lighting. 				
Contrast	0-100	<ul style="list-style-type: none"> Properly adjust Contrast to relax your eyes. 				
Sharpness	0-5	<ul style="list-style-type: none"> Sharpness improves clarity and details of images. 				
Color Temperature	Cool	<ul style="list-style-type: none"> Use Up or Down Button to select and preview mode effects. Press the OK Button to confirm and apply your mode type. Users can adjust Color Temperature in Customization mode. 				
	Normal					
	Warm					
	Customization		R (0-100)			
		G (0-100)				
		B (0-100)				
Screen Size	Auto	<ul style="list-style-type: none"> Users can adjust Screen Size in any mode, any resolution and any screen refresh rate. Activating Screen Size 1:1 will affect: <table border="1" data-bbox="578 1278 929 1337"> <thead> <tr> <th>Affected Function</th> <th>Function Status</th> </tr> </thead> <tbody> <tr> <td>» PIP/PBP</td> <td>Set to OFF</td> </tr> </tbody> </table> <p> Important</p> <p>Screen Size 1:1 refers to displaying content at its original resolution. This option is disabled when the monitor is set to its native resolution.</p>	Affected Function	Function Status	» PIP/PBP	Set to OFF
	Affected Function		Function Status			
	» PIP/PBP		Set to OFF			
	4:3					
16:9						
1:1						

Input Source

1st Level Menu	2nd Level Menu	Description
HDMI™ 1		<ul style="list-style-type: none"> Users can adjust Input Source in any mode.
HDMI™ 2		
DP		
Auto Scan	OFF	<ul style="list-style-type: none"> Users can use the Navi Key to select Input Source at below status: <ul style="list-style-type: none"> While “Auto Scan” is set to “OFF” with the monitor at power saving mode; While “No Signal” message box is shown on the monitor.
	ON	

PIP/PBP

1st Level Menu	2nd/3rd Level Menu		Description																
OFF			<ul style="list-style-type: none"> PIP (Picture in Picture) allows users to simultaneously display multiple video sources on one screen. One program is displayed on the full screen at the same time as one or more other programs are displayed in inset windows. PBP (Picture by Picture) is a similar feature that displays two input sources side-by-side on the screen. Display Switch allows users to switch between primary and secondary input sources. If there is only one signal input, the Display Switch and Audio Switch will be grayed out. Activating PIP/PBP will affect: <table border="1" data-bbox="578 948 929 1222"> <thead> <tr> <th>Affected Function</th> <th>Function Status</th> </tr> </thead> <tbody> <tr> <td>» Response Time</td> <td>Unable to select</td> </tr> <tr> <td>» Adaptive-Sync</td> <td>Set to OFF</td> </tr> <tr> <td>» MPRT</td> <td></td> </tr> <tr> <td>» HDMI™ Console Mode</td> <td>Set to OFF & unable to select</td> </tr> <tr> <td>» HDMI™ CEC</td> <td></td> </tr> <tr> <td>» PIP: Screen Size 1:1</td> <td>Set to Auto & unable to select</td> </tr> <tr> <td>» PBP: Screen Size</td> <td></td> </tr> </tbody> </table> 	Affected Function	Function Status	» Response Time	Unable to select	» Adaptive-Sync	Set to OFF	» MPRT		» HDMI™ Console Mode	Set to OFF & unable to select	» HDMI™ CEC		» PIP: Screen Size 1:1	Set to Auto & unable to select	» PBP: Screen Size	
Affected Function	Function Status																		
» Response Time	Unable to select																		
» Adaptive-Sync	Set to OFF																		
» MPRT																			
» HDMI™ Console Mode	Set to OFF & unable to select																		
» HDMI™ CEC																			
» PIP: Screen Size 1:1	Set to Auto & unable to select																		
» PBP: Screen Size																			
PIP	Source	HDMI™ 1																	
		HDMI™ 2																	
		DP																	
	PIP Size	Small																	
		Medium																	
		Large																	
	Location	Left Top																	
		Right Top																	
		Left Bottom																	
		Right Bottom																	
Display Switch																			
Audio Switch																			
PBP	Source 1	HDMI™ 1																	
		HDMI™ 2																	
		DP																	
	Source 2	HDMI™ 1																	
		HDMI™ 2																	
		DP																	
	Display Switch																		
	Audio Switch																		

Navi Key

1st Level Menu	2nd Level Menu	Description
Up Down Left Right	OFF	<ul style="list-style-type: none"> All Navi Key items can be adjusted via OSD Menus.
	Brightness	
	Game Mode	
	Smart Crosshair	
	Alarm Clock	
	Input Source	
	PIP/PBP Mode	
	Refresh Rate	
	Info. On Screen	
	Night Vision	

Settings

1st Level Menu	2nd Level Menu	Description
Language	繁體中文	<ul style="list-style-type: none"> Users have to press the OK Button to confirm and apply the Language setting. Language is an independent setting. Users' own language setting will override the factory default. When users set Reset to Yes, Language will not be changed.
	English	
	Français	
	Deutsch	
	Italiano	
	Español	
	한국어	
	日本語	
	Русский	
	Português	
	简体中文	
	Bahasa Indonesia	
	Türkçe	
(More languages coming soon)		
Transparency	0~5	<ul style="list-style-type: none"> Users can adjust Transparency in any mode.
OSD Time Out	5~30s	<ul style="list-style-type: none"> Users can adjust OSD Time Out in any mode.
Power Button	OFF	<ul style="list-style-type: none"> When set to OFF, users can press the power button to turn off the monitor.
	Standby	<ul style="list-style-type: none"> When set to Standby, users can press the power button to turn off the panel and backlight.

1st Level Menu	2nd Level Menu	Description
Info. On Screen	OFF	<ul style="list-style-type: none"> The information of the monitor status will be shown on the right side of the screen.
	ON	
HDMI™ CEC	OFF	<ul style="list-style-type: none"> HDMI™ CEC (Consumer Electronics Control) supports Sony PlayStation®, Nintendo® Switch™, Xbox Series X S consoles and various audio-visual devices that are CEC-capable. If HDMI™ CEC is set to ON: <ul style="list-style-type: none"> The monitor will automatically power on when the CEC device is turned on. The CEC device will enter power saving mode when the monitor is turned off. When Sony PlayStation®, Nintendo® Switch™, or Xbox Series X S console is connected, Game Mode and Pro Mode will be automatically set to default modes and can be adjusted to users' preferred modes later.
	ON	
Reset	YES	<ul style="list-style-type: none"> Users can Reset and restore settings to original OSD Default in any mode.
	NO	

Specifications*

Monitor	MAG 321CQF E18
Size	31.5 inch
Curvature	1500R
Panel Type	Rapid VA
Resolution	2560x1440 (WQHD)
Aspect Ratio	16:9
Brightness	Typical SDR: 300 nits
Contrast Ratio	3000:1
Refresh Rate	180Hz
Response Time	<ul style="list-style-type: none">• GTG: 0.5ms (Min.)• MPRT: 1ms
I/O	<ul style="list-style-type: none">• 2 x HDMI™ Connector• 1 x DisplayPort• 1 x Headphone Jack
View Angles	178°(H) , 178°(V)
DCI-P3** / sRGB	92% / 124%
Surface Treatment	Anti-glare
Display Colors	1.07B, 10 bits (8 bits + FRC)
Monitor Power Options	100-240V~, 50/60Hz, 1.5A max
Power Consumption (Typical)	Power On < 65W Standby < 0.5W Power Off < 0.3W
Adjustment (Tilt)	-5° ~ 20°
Kensington Lock	Yes

Monitor		MAG 321CQF E18
VESA Mounting		<ul style="list-style-type: none"> • Plate Type: 100 x 100 mm • Screw Type: M4 x 10 mm <ul style="list-style-type: none"> • Thread Diameter: 4 mm • Thread Pitch: 0.7 mm • Thread Length: 10 mm
Dimension (W x H x D)		711.55 x 503.15 x 269.49 mm
Weight	Net	6.34 kg
	Gross	9.4 kg
Operating Environment		<ul style="list-style-type: none"> • Temperature: 0°C to 40°C • Humidity: 20% to 90%, non-condensing • Altitude: 0 ~ 5000m
Storage Environment		<ul style="list-style-type: none"> • Temperature: -20°C to 60°C • Humidity: 10% to 90%, non-condensing

* Some technical specifications of the device may be subject to change by the manufacturer. Please verify the specifications with the seller or the manufacturer's representative.

** Based on CIE1976 test standards.

Preset Display Modes

Important

- All information is subject to change without prior notice.
- HDMI™ VRR (Variable Refresh Rate) synchronizes with Adaptive-Sync (ON/ OFF). For VRR ON/OFF status, please check Adaptive-Sync.
- The 2160P video resolution will be enabled when HDMI™ Console Mode is turned ON.

Standard Mode (HDMI™ Console Mode ON)

Standard	Resolution		HDMI™	DP
VGA	640x480	@60Hz	V	V
		@67Hz	V	V
		@72Hz	V	V
		@75Hz	V	V
Dos-Mode	720x480	@60Hz	V	V
	720x576	@50Hz	V	V
SVGA	800x600	@56Hz	V	V
		@60Hz	V	V
		@72Hz	V	V
		@75Hz	V	V
XGA	1024x768	@60Hz	V	V
		@70Hz	V	V
		@75Hz	V	V
SXGA	1280x1024	@60Hz	V	V
		@75Hz	V	V
WSXGA+	1680x1050	@60Hz	V	V
QHD	2560x1440	@60Hz	V	V
		@120Hz	V	V
		@144Hz	V	V
		@165Hz		V
		@180Hz		V
Video Timing Resolution	720P		V	V
	1080P	@60Hz	V	V
		@120Hz	V	V
	2160P	@30Hz	V	
@60Hz		V		
HDMI™ VRR			V	

Standard Mode (HDMI™ Console Mode OFF)

Standard	Resolution		HDMI™	DP
VGA	640x480	@60Hz	V	V
		@67Hz	V	V
		@72Hz	V	V
		@75Hz	V	V
Dos-Mode	720x480	@60Hz	V	V
	720x576	@50Hz	V	V
SVGA	800x600	@56Hz	V	V
		@60Hz	V	V
		@72Hz	V	V
		@75Hz	V	V
XGA	1024x768	@60Hz	V	V
		@70Hz	V	V
		@75Hz	V	V
SXGA	1280x1024	@60Hz	V	V
		@75Hz	V	V
WSXGA+	1680x1050	@60Hz	V	V
QHD	2560x1440	@60Hz	V	V
		@120Hz	V	V
		@144Hz	V	V
		@165Hz		V
		@180Hz		V
Video Timing Resolution	720P		V	V
	1080P	@60Hz	V	V
		@120Hz	V	V
HDMI™ VRR			V	

PIP Mode (Not Support HDR)

Standard	Resolution		HDMI™	DP
Full HD	1920x1080	@60Hz	V	V
QHD	2560x1440	@60Hz	V	V
Video Timing Resolution	720P		V	V
	1080P	@60Hz	V	V
	2160P	@30Hz	V	V
		@50Hz	V	V
		@60Hz	V	V

PBP Mode (Not Support HDR)

Standard	Resolution		HDMI™	DP
Video Timing Resolution	720P		V	V
Used for PBP Full Screen	1280x1440	@60Hz	V	V

Troubleshooting

The power LED is off.

- Press the monitor power button again.
- Check if the monitor power cable is properly connected.

No image.

- Check if the computer graphics card is properly installed.
- Check if the computer and monitor are connected to electrical outlets and are turned on.
- Check if the monitor signal cable is properly connected.
- The computer may be in Standby mode. Press any key to activate the monitor.

The screen image is not properly sized or centered.

- Refer to Preset Display Modes to set the computer to a setting suitable for the monitor to display.

No Plug & Play.

- Check if the monitor power cable is properly connected.
- Check if the monitor signal cable is properly connected.
- Check if the computer and graphics card are Plug & Play compatible.

The icons, font or screen are fuzzy, blurry or have color problems.

- Avoid using any video extension cables.
- Adjust brightness and contrast.
- Adjust RGB color or tune color temperature.
- Check if the monitor signal cable is properly connected.
- Check for bent pins on the signal cable connector.

The monitor starts flickering or shows waves.

- Change the refresh rate to match the capabilities of your monitor.
- Update your graphics card drivers.
- Keep the monitor away from electrical devices that may cause electromagnetic interference (EMI).

Safety Instructions

- Read the safety instructions carefully and thoroughly.
- All cautions and warnings on the device or User Guide should be noted.
- Refer servicing to qualified personnel only.

Power

- Make sure that the power voltage is within its safety range and has been adjusted properly to the value of 100~240V before connecting the device to the power outlet.
- If the power cord comes with a 3-pin plug, do not disable the protective earth pin from the plug. The device must be connected to an earthed mains socket-outlet.
- Please confirm the power distribution system in the installation site shall provide the circuit breaker rated 120/240V, 20A (maximum).
- Always disconnect the power cord or switch the wall socket off if the device would be left unused for a certain time to achieve zero energy consumption.
- Place the power cord in a way that people are unlikely to step on it. Do not place anything on the power cord.
- If this device comes with an adapter, use only the MSI provided AC adapter approved for use with this device.

Environment

- To reduce the possibility of heat-related injuries or of overheating the device, do not place the device on a soft, unsteady surface or obstruct its air ventilators.
- Use this device only on a hard, flat and steady surface.
- To prevent the device from tipping over, secure the device to a desk, wall or fixed object with an anti-tip fastener that helps to properly support the device and keep it safe in place.
- To prevent fire or shock hazard, keep this device away from humidity and high temperature.
- Do not leave the device in an unconditioned environment with a storage temperature above 60°C or below -20°C, which may damage the device.
- The maximum operating temperature is around 40°C.
- When cleaning the device, be sure to remove the power plug. Use a piece of soft cloth rather than industrial chemical to clean the device. Never pour any liquid into the opening; that could damage the device or cause electric shock.
- Always keep strong magnetic or electrical objects away from the device.

- If any of the following situations arises, get the device checked by service personnel:
 - The power cord or plug is damaged.
 - Liquid has penetrated into the device.
 - The device has been exposed to moisture.
 - The device does not work well or you can not get it working according to the User Guide.
 - The device has dropped and damaged.
 - The device has obvious sign of breakage.

TÜV Rheinland Certification

TÜV Rheinland Low Blue Light Certification

Blue light has been shown to cause eye fatigue and discomfort. MSI now offers monitors with TÜV Rheinland Low Blue Light certification to ensure users' eye comfort and well-being. Please follow the instructions below to reduce the symptoms from extended exposure to the screen and blue light.



Low Blue Light
(Software
Solution)

www.tuv.com

- Place the screen 20 – 28 inches (50 – 70 cm) away from your eyes and a little below eye level.
- Consciously blinking the eyes every now and then will help to reduce eye strain after extended screen time.
- Take breaks for 20 minutes every 2 hours.
- Look away from the screen and gaze at a distant object for at least 20 seconds during breaks.
- Make stretches to relieve body fatigue or pain during breaks.
- Turn on the optional Low Blue Light function.

TÜV Rheinland Flicker Free Certification

- TÜV Rheinland has tested this product to ascertain whether the display produces visible and invisible flicker for the human eye and therefore strains the eyes of users.
- TÜV Rheinland has defined a catalogue of tests, which sets out minimum standards at various frequency ranges. The test catalogue is based on internationally applicable standards or standards common within the industry and exceeds these requirements.
- The product has been tested in the laboratory according to these criteria.
- The keyword “Flicker Free” confirms that the device has no visible and invisible flicker defined in this standard within the range of 0 - 3000 Hz under various brightness settings.
- The display will not support Flicker Free when Anti Motion Blur/MPRT is enabled. (The availability of Anti Motion Blur/MPRT varies by products.)



Flicker Free

www.tuv.com

Regulatory Notices

CE Conformity

This product has been tested and found to comply with the harmonized standards for Information Technology Equipment published under Directives of Official Journal of the European Union.



FCC-B Radio Frequency Interference Statement

This equipment has been tested and found to comply with the limits for a Class B digital device, pursuant to Part 15 of the FCC Rules. These limits are designed to provide reasonable protection against harmful interference in a residential installation. This equipment generates, uses and can radiate radio frequency energy and, if not installed and used in accordance with the instruction manual, may cause harmful interference to radio communications. However, there is no guarantee that interference will not occur in a particular installation. If this equipment does cause harmful interference to radio or television reception, which can be determined by turning the equipment off and on, the user is encouraged to try to correct the interference by one or more of the measures listed below:



- Reorient or relocate the receiving antenna.
- Increase the separation between the equipment and receiver.
- Connect the equipment into an outlet on a circuit different from that to which the receiver is connected.
- Consult the dealer or an experienced radio/television technician for help.

Notice 1

The changes or modifications not expressly approved by the party responsible for compliance could void the user's authority to operate the equipment.

Notice 2

Shielded interface cables and AC power cord, if any, must be used in order to comply with the emission limits.

This device complies with Part 15 of the FCC Rules. Operation is subject to the following two conditions:

1. This device may not cause harmful interference, and
2. This device must accept any interference received, including interference that may cause undesired operation.

MSI Computer Corp.

901 Canada Court, City of Industry, CA 91748, USA

(626) 913-0828

www.msi.com

WEEE Statement

Under the European Union (“EU”) Directive on Waste Electrical and Electronic Equipment, Directive 2012/19/EU, products of “electrical and electronic equipment” cannot be discarded as municipal waste anymore and manufacturers of covered electronic equipment will be obligated to take back such products at the end of their useful life.



Chemical Substances Information

In compliance with chemical substances regulations, such as the EU REACH Regulation (Regulation EC No. 1907/2006 of the European Parliament and the Council), MSI provides the information of chemical substances in products at:

<https://csr.msi.com/global/index>

RoHS Statement

Japan JIS C 0950 Material Declaration

A Japanese regulatory requirement, defined by specification JIS C 0950, mandates that manufacturers provide material declarations for certain categories of electronic products offered for sale after July 1, 2006.

<https://csr.msi.com/global/Japan-JIS-C-0950-Material-Declarations>

India RoHS

This product complies with the “India E-waste (Management and Handling) Rule 2016” and prohibits use of lead, mercury, hexavalent chromium, polybrominated biphenyls or polybrominated diphenyl ethers in concentrations exceeding 0.1 weight % and 0.01 weight % for cadmium, except for the exemptions set in Schedule 2 of the Rule.

Turkey EEE Regulation

Conforms to the EEE Regulations of the Republic Of Turkey

Ukraine Restriction of Hazardous Substances

The equipment complies with requirements of the Technical Regulation, approved by the Resolution of Cabinet of Ministry of Ukraine as of 10 March 2017, № 139, in terms of restrictions for the use of certain dangerous substances in electrical and electronic equipment.

Vietnam RoHS

As from December 1, 2012, all products manufactured by MSI comply with Circular 30/2011/TT-BCT temporarily regulating the permitted limits for a number of hazardous substances in electronic and electric products.

Green Product Features

- Reduced energy consumption during use and stand-by
- Limited use of substances harmful to the environment and health
- Easily dismantled and recycled
- Reduced use of natural resources by encouraging recycling
- Extended product lifetime through easy upgrades
- Reduced solid waste production through take-back policy

Environmental Policy

- The product has been designed to enable proper reuse of parts and recycling and should not be thrown away at its end of life.
- Users should contact the local authorized point of collection for recycling and disposing of their end-of-life products.
- Visit the MSI website and locate a nearby distributor for further recycling information.
- Users may also reach us at gpcontdev@msi.com for information regarding proper disposal, take-back, recycling, and disassembly of MSI products.
- Please visit <https://us.msi.com/page/recycling> for information regarding the recycling of your product in the US.



Warning!

Overuse of screens is likely to affect eyesight.

Recommendations:

1. Take a 10-minute break for every 30 minutes of screen time.
2. Children under 2 years of age should have no screen time. For children aged 2 years and over, screen time should be limited to less than one hour per day.

Copyright and Trademarks Notice



Copyright © Micro-Star Int'l Co., Ltd. All rights reserved. The MSI logo used is a registered trademark of Micro-Star Int'l Co., Ltd. All other marks and names mentioned may be trademarks of their respective owners. No warranty as to accuracy or completeness is expressed or implied. MSI reserves the right to make changes to this document without prior notice.



The terms HDMI™, HDMI™ High-Definition Multimedia Interface, HDMI™ Trade dress and the HDMI™ Logos are trademarks or registered trademarks of HDMI™ Licensing Administrator, Inc.

Technical Support

If a problem arises with your product and no solution can be obtained from the user's manual, please contact your place of purchase or local distributor. Alternatively, please visit <https://www.msi.com/support/> for further guidance.

Ovaj dokument je originalno proizveden i objavljen od strane proizvođača, brenda MSI, i preuzet je sa njihove zvanične stranice. S obzirom na ovu činjenicu, Tehnoteka ističe da ne preuzima odgovornost za tačnost, celovitost ili pouzdanost informacija, podataka, mišljenja, saveta ili izjava sadržanih u ovom dokumentu.

Napominjemo da Tehnoteka nema ovlašćenje da izvrši bilo kakve izmene ili dopune na ovom dokumentu, stoga nismo odgovorni za eventualne greške, propuste ili netačnosti koje se mogu naći unutar njega. Tehnoteka ne odgovara za štetu nanесenu korisnicima pri upotrebi netačnih podataka. Ukoliko imate dodatna pitanja o proizvodu, ljubazno vas molimo da kontaktirate direktno proizvođača kako biste dobili sve detaljne informacije.

Za najnovije informacije o ceni, dostupnim akcijama i tehničkim karakteristikama proizvoda koji se pominje u ovom dokumentu, molimo posetite našu stranicu klikom na sledeći link:

<https://tehnoteka.rs/p/msi-zakrivljeni-monitor-32-rapid-va-321cqf-e18-akcija-cena/>