

Uputstvo za upotrebu (EN)

SAMSUNG Galaxy S24 Enterprise Edition 8/128GB Onyx Black

SAMSUNG



Tehnoteka je online destinacija za upoređivanje cena i karakteristika bele tehnike, potrošačke elektronike i IT uređaja kod trgovinskih lanaca i internet prodavnica u Srbiji. Naša stranica vam omogućava da istražite najnovije informacije, detaljne karakteristike i konkurentne cene proizvoda.

Posetite nas i uživajte u ekskluzivnom iskustvu pametne kupovine klikom na link:

<https://tehnoteka.rs/p/samsung-galaxy-s24-enterprise-edition-8128gb-onyx-black-akcija-cena/>

SAMSUNG

USER GUIDE

SM-S921B
SM-S921B/DS
SM-S921B/DS UD
SM-S926B
SM-S926B/DS
SM-S926B/DS UD
SM-S928B
SM-S928B/DS
SM-S928B/DS UD

English. 05/2025. Rev.1.1

www.samsung.com

Table of Contents

Getting started

- 5 Introduction
- 6 Device layout and functions
- 14 Charging the battery
- 19 Nano-SIM card and eSIM
- 21 Turning the device on and off
- 22 Initial setup
- 23 Using networks
- 23 Samsung account
- 24 Transferring data from your previous device (Smart Switch)
- 25 Understanding the screen
- 32 Notification panel
- 33 Quick settings panel
- 35 Screen capture and screen record
- 37 Entering text
- 38 Extracting text

Apps and features

- 39 Introduction
- 40 Installing or uninstalling apps
- 42 Galaxy AI
- 49 S Pen (Galaxy S24 Ultra)
- 59 Phone
- 62 Contacts
- 65 Messages
- 67 Camera

- 84 Gallery
- 90 Bixby
- 91 Bixby Vision
- 92 Multi window (Using multiple apps at once)
- 93 Samsung Internet
- 94 Samsung Wallet
- 98 Samsung Health
- 98 Samsung Notes
- 103 Samsung Members
- 103 Samsung Kids
- 104 Samsung Global Goals
- 104 Samsung TV Plus
- 104 Samsung Find
- 104 Samsung Shop
- 105 Galaxy Shop
- 105 Galaxy Wearable
- 105 PENUP (Galaxy S24 Ultra)
- 106 Calendar
- 106 Reminder
- 107 Voice Recorder
- 108 My Files (Checking and managing the files)
- 108 Clock
- 108 Calculator
- 109 Gaming Hub
- 109 Game Booster (Configuring your gaming environment)
- 111 SmartThings

- 112 Sharing content
- 113 Music Share
- 114 Smart View (Mirroring on a TV screen)
- 115 Samsung DeX
- 117 Google apps

Settings

- 118 Introduction
- 119 Sign in to your Galaxy
- 119 Connections
 - 120 Wi-Fi
 - 122 Bluetooth
 - 123 NFC and contactless payments (NFC-enabled models)
 - 124 Data saver
 - 124 Allowed networks for apps
 - 125 Mobile Hotspot
 - 125 More connection settings
- 127 Connected devices
- 128 Galaxy AI
- 128 Modes and Routines
 - 128 Using modes
 - 129 Using routines
- 130 Sounds and vibration
 - 131 Sound quality and effects
 - 131 Separate app sound
- 132 Notifications
- 132 Display
 - 134 Motion smoothness
 - 134 Changing the screen mode or adjusting the display colour

- 135 Battery
- 136 Wallpaper and style
- 136 Themes
- 136 Home screen
- 137 Lock screen and AOD
 - 138 Extend Unlock
 - 138 Always On Display (Displaying information when the screen is turned off)
- 139 Security and privacy
 - 140 Face recognition
 - 142 Fingerprint recognition
 - 144 Secure Wi-Fi
 - 145 Secure Folder
 - 148 Samsung Pass
- 149 Location
- 150 Safety and emergency
- 151 Accounts and backup
 - 151 Samsung Cloud
- 152 Google
- 153 Advanced features
 - 154 Motions and gestures
 - 155 Video effects
 - 155 Galaxy Avatar
 - 156 Dual Messenger
- 157 Digital Wellbeing and parental controls
- 157 Device care
- 158 Apps
- 159 General management
- 160 Accessibility
- 160 Software update
- 161 About phone

Usage notices

- 163 Precautions for using the device
- 166 Notes on package contents and accessories
- 167 Maintaining water and dust resistance
- 168 Device overheating situations and solutions
- 171 How to find the standby power consumption information for this product

Appendix

- 173 Accessibility
- 186 Troubleshooting
- 191 Removing the battery

Getting started

Introduction

Get to know the basics of your device.

This chapter is a common guide for how to use Samsung devices.

Depending on the model, some content may differ, or descriptions of options or features not available on your device may be included.



Device layout and functions

► Galaxy S24 Ultra:

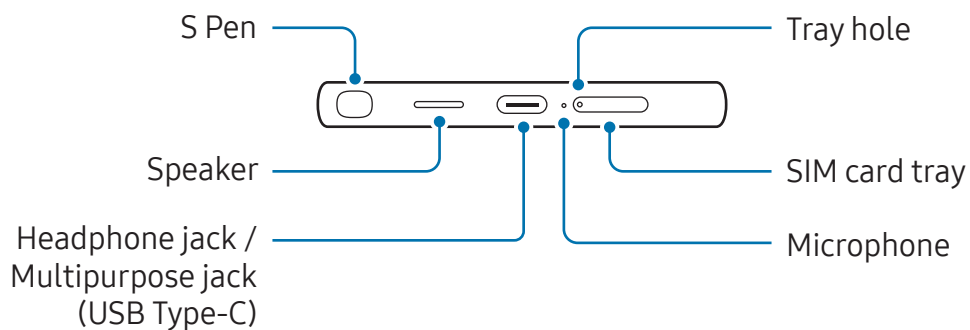
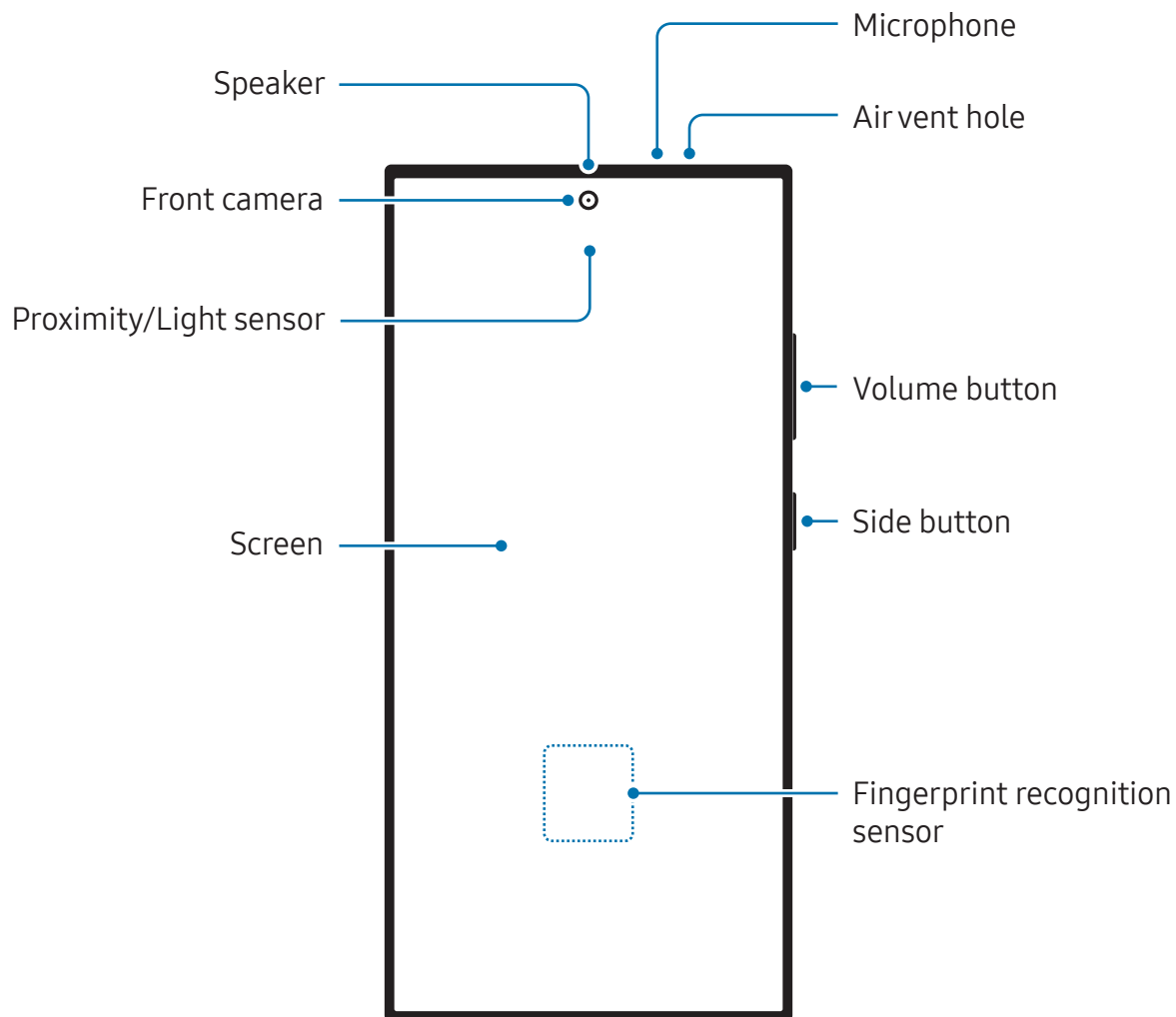

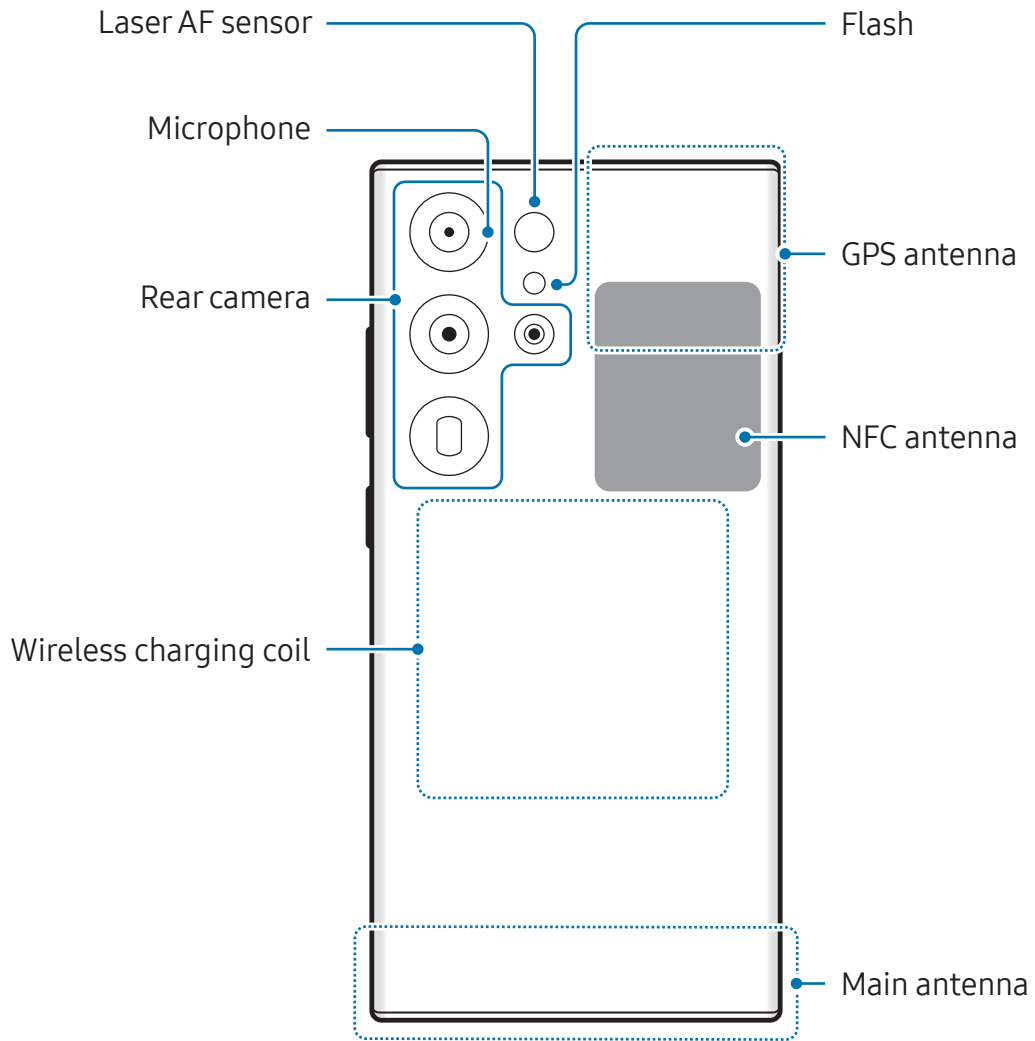

► Galaxy S24+:

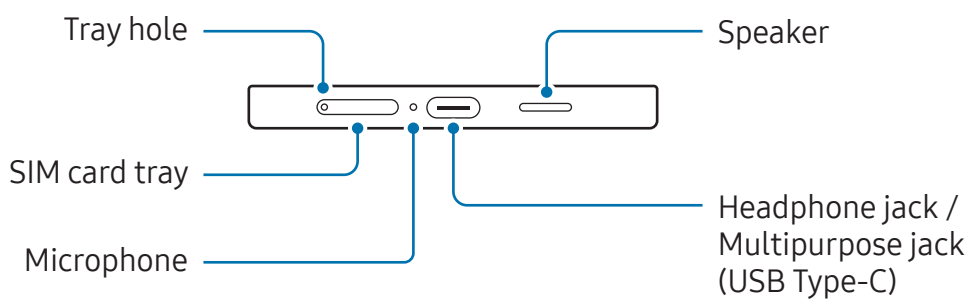
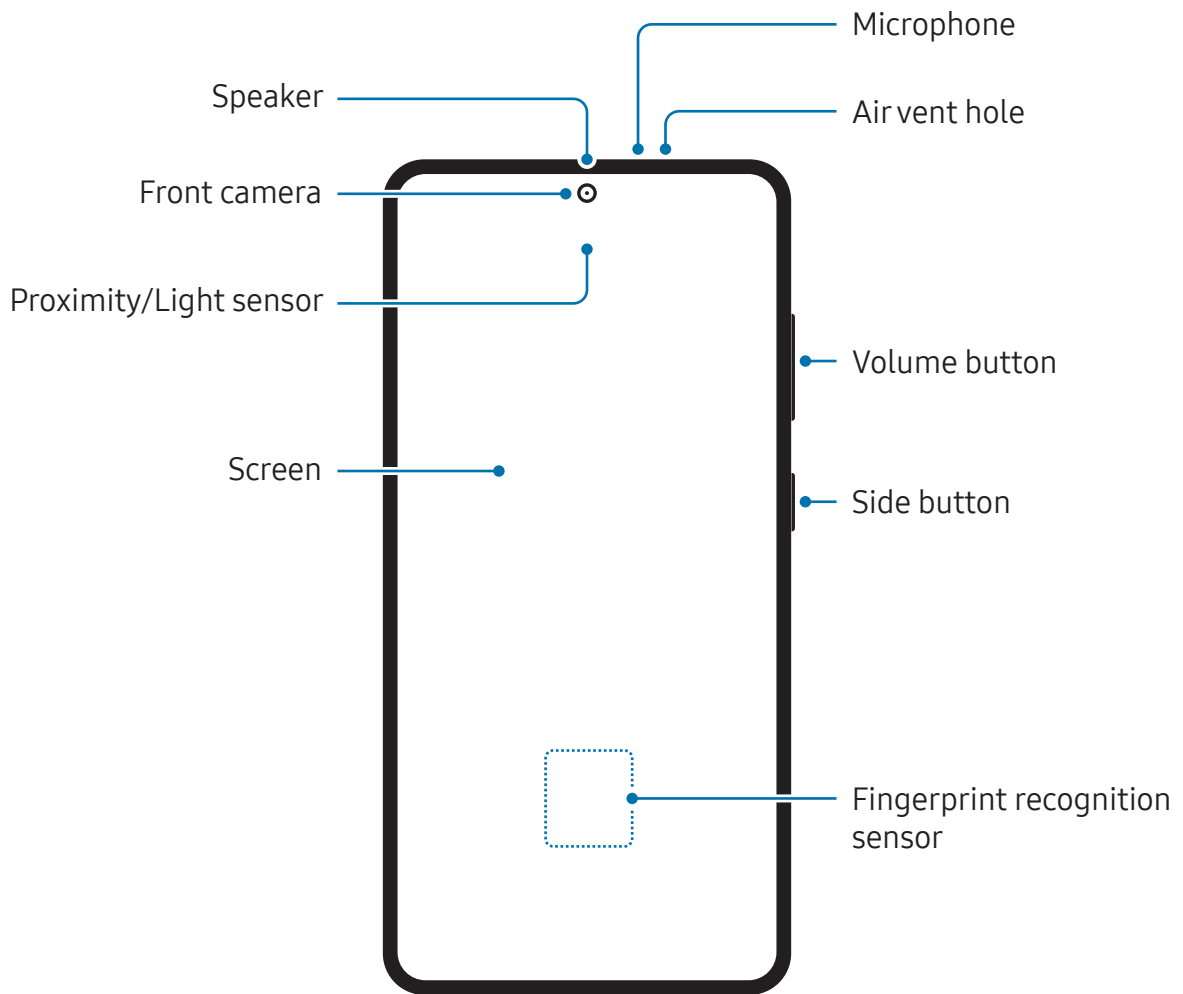

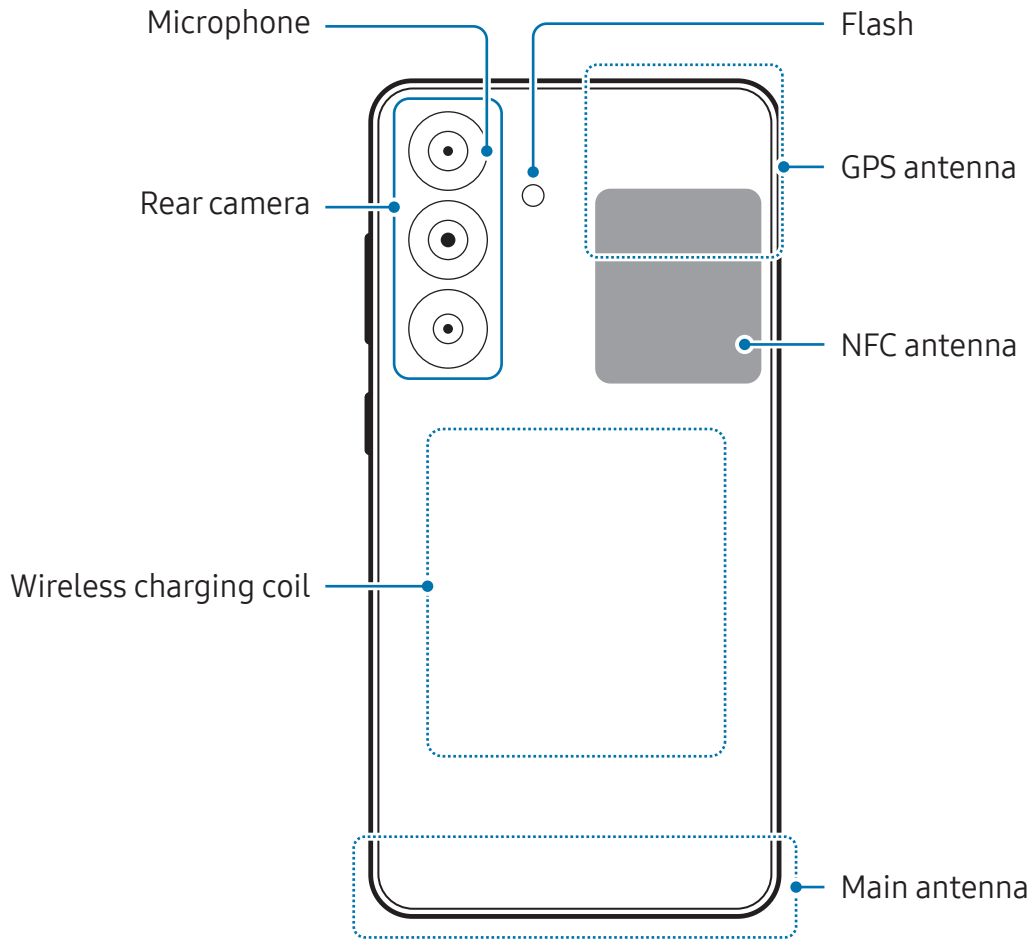

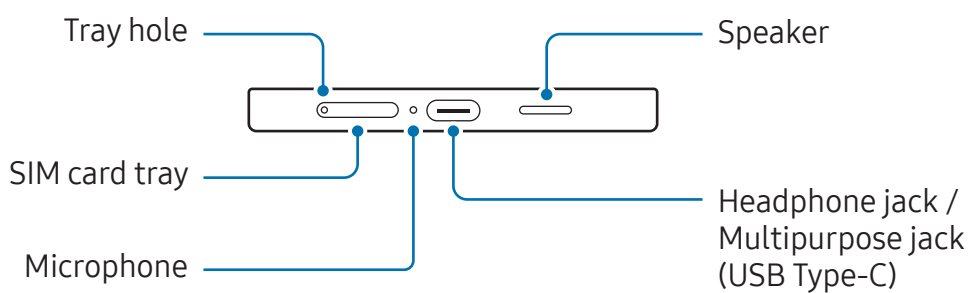
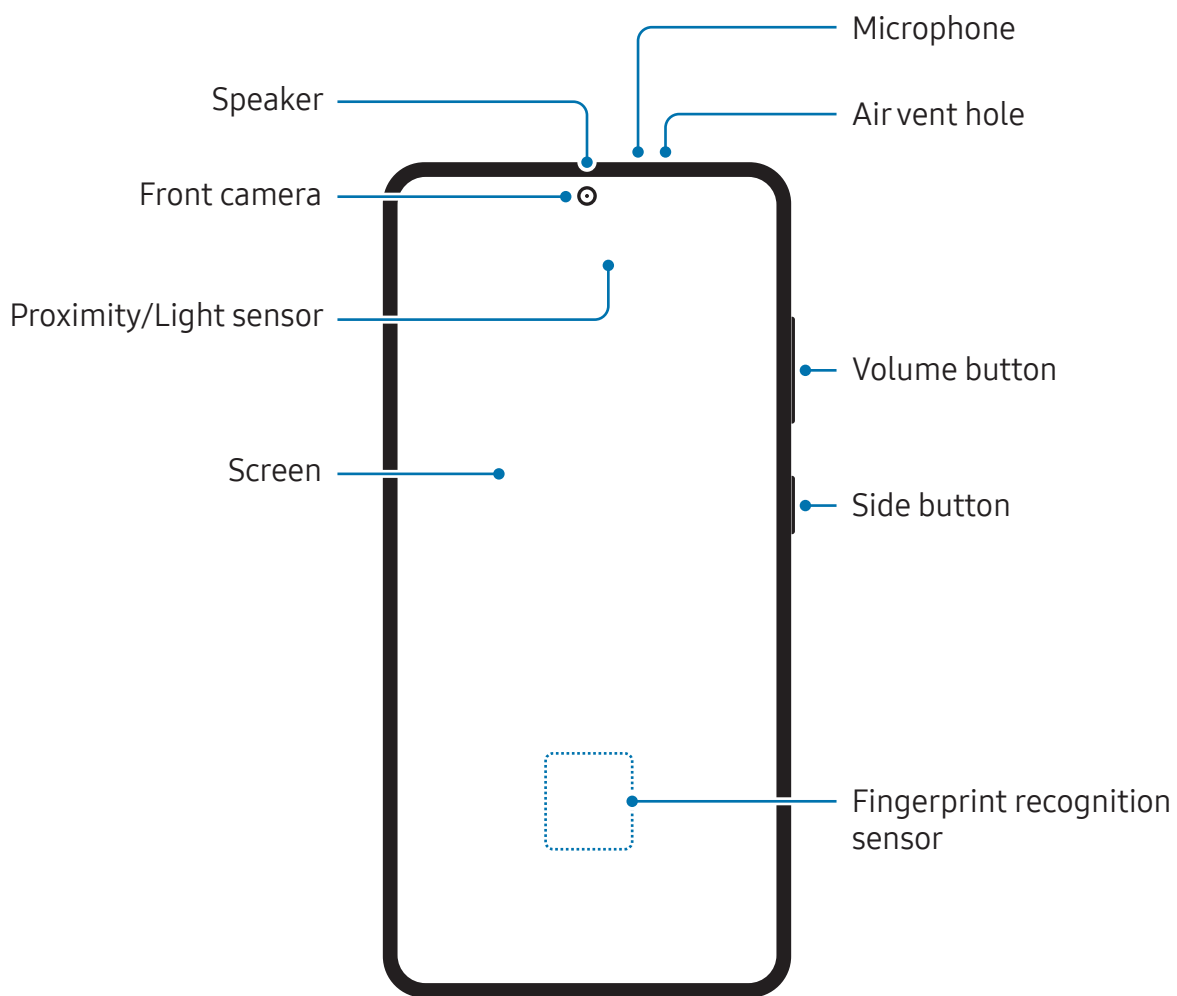

► Galaxy S24:

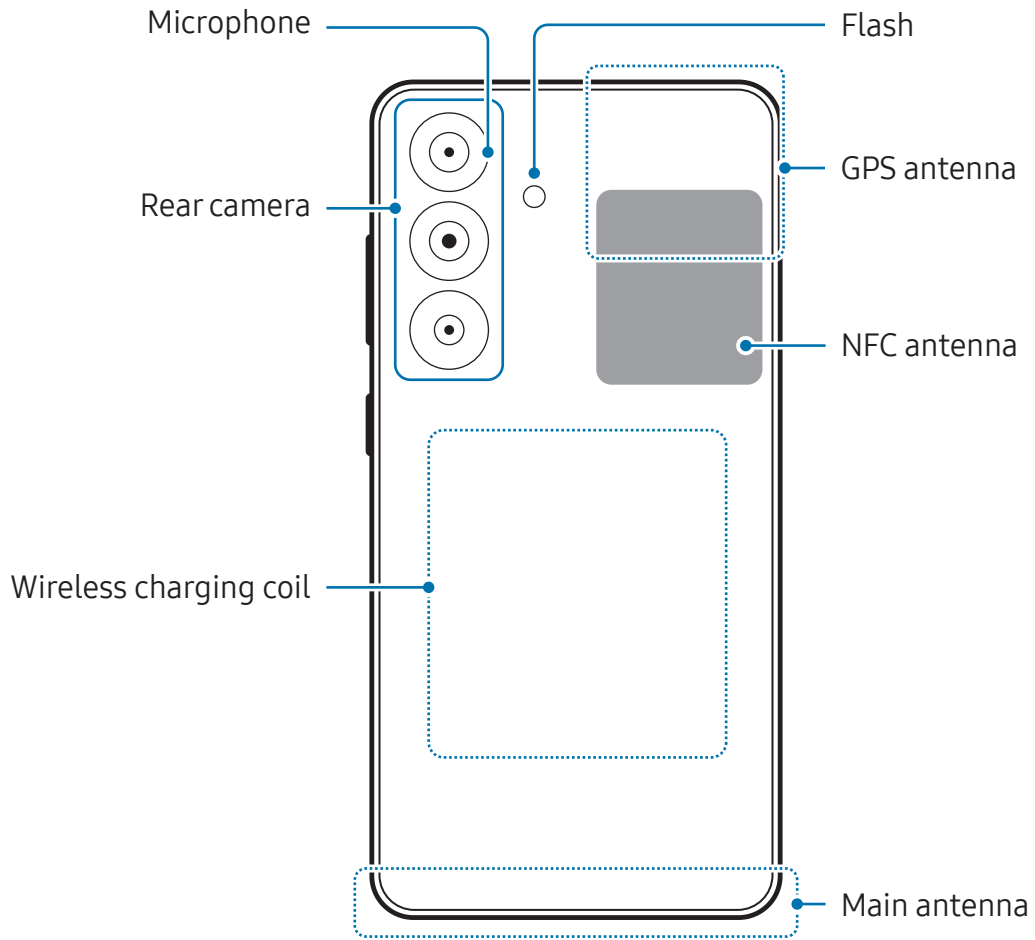



-  When using the speakers, such as when playing media files or using speakerphone, do not place the device close to your ears.
- Be careful not to expose the camera lens to a strong light source, such as direct sunlight. If the camera lens is exposed to a strong light source, such as direct sunlight, the camera image sensor may be damaged. A damaged image sensor is irreparable and will cause dots or spots in pictures.
- If you use the device with its glass or acrylic body broken, there may be a risk of injury. Use the device only after it has been repaired at a Samsung Service Centre or an authorised service centre.
- If dust or foreign materials enter the microphone, speaker, or receiver, or if these parts are covered, the device's sound may become quiet or certain features may not work. If you attempt to remove the dust or foreign materials with a sharp object, the device may be damaged and its appearance may be affected.
-  Connectivity problems and battery drain may occur in the following situations:
 - If you attach metallic stickers on the antenna area of the device
 - If you attach a device cover made with metallic material to the device
 - If you cover the device's antenna area with your hands or other objects while using certain features, such as calls or the mobile data connection
- If the air vent hole is covered by an accessory, such as a protective film or sticker, unwanted noises may occur during calls or media playback.
- Do not cover the proximity/light sensor area with accessories, such as stickers or a cover. Doing so may cause the sensor to malfunction.
- The light may flicker at the top of the device during calls because of proximity sensor operation.

Hard buttons

Button	Function
Side button	<ul style="list-style-type: none">• When the device is off, press and hold to turn it on.• Press to turn on or lock the screen.• Press and hold to start a conversation with Bixby. Refer to Bixby for more information.• Press twice or press and hold to open the app or feature you set.
Side button + Volume Down button	<ul style="list-style-type: none">• Press simultaneously to capture a screenshot.• Press and hold simultaneously to turn off the device.

Setting the Side button

Select an app or feature to launch by pressing the Side button twice or pressing and holding the Side button.

Open **Settings**, tap **Advanced features** → **Side button**, and then select an option you want.

Soft buttons

When you turn on the screen, the soft buttons will appear at the bottom of the screen. Refer to [Navigation bar \(soft buttons\)](#) for more information.

Charging the battery

Charge the battery before using it for the first time or when it has been unused for extended periods.

Wired charging

Connect the USB cable to the USB power adapter and plug the cable into the device's multipurpose jack to charge the battery. After fully charging, disconnect the charger from the device.

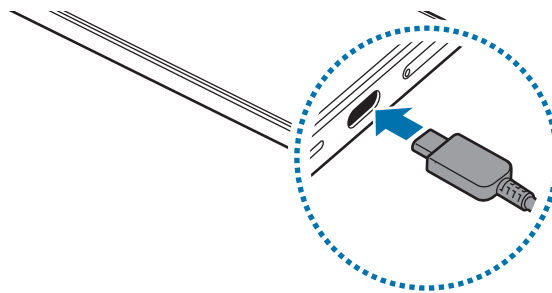

Wireless charging

The device has a built-in wireless charging coil. You can charge the battery using a wireless charger (sold separately).

Place the centre of the device's back on the centre of the wireless charger to charge the battery. After fully charging, disconnect the device from the wireless charger.

The estimated charging time will appear on the notification panel. The actual charging time assumes that the device is not in use, and it may vary depending on the charging conditions. Wireless charging may not work smoothly depending on the type of accessory or cover. For stable wireless charging, it is recommended to separate the cover or accessory from the device.

Precautions for wireless charging

If you do not follow the precautions, the device may not charge properly or may overheat, or the device and any cards may be damaged.

- Do not place the device on the wireless charger with a credit card or radio-frequency identification (RFID) card (such as a transportation card or a key card) placed between the back of the device and the device cover.
- Do not place the device on the wireless charger when conductive materials, such as metal objects and magnets, are placed between the device and the wireless charger.
-  • If you use the wireless charger in areas with weak network signals, you may lose network reception.
- Use of Samsung-approved wireless chargers is recommended. Using other wireless chargers may result in improper charging.

Quick charging



Use a super fast charger or fast charger. To use the fast wireless charging feature, use a charger and components that support the feature.

You can check the connection status of the charger by opening **Settings** and tapping **Battery**.

-  • If fast charging does not work, open **Settings**, tap **Battery** → **Charging settings**, and then check if the feature you want is turned on. Also, check if the USB cable and the USB power adapter are connected properly.
- You can charge the battery more quickly while the device or its screen is turned off.
- If the wireless charger has an internal fan, the fan may produce noise during fast wireless charging. Add a routine to set the fast wireless charging feature to turn off automatically at the preset time using **Routines**. When the fast wireless charging feature turns off, the charger's fan noise and the indicator light will be reduced.

Wireless power sharing

You can charge another device with your phone's battery. You can still charge another device even while charging your phone. Depending on the type of accessories or cover being used, the Wireless power sharing feature may not work properly. It is recommended to remove any accessories and cover being used before using this feature.

- 1 Open **Settings**, tap **Battery** → **Wireless power sharing**, and then tap the switch to turn it on.
 - 2 Place the other device on the centre of your phone, with their backs facing.
 - 3 When you are finished charging, disconnect the other device from your phone.
-  Do not use headphones while sharing power. Doing so may affect nearby devices.
-  • The location of the wireless charging coil may differ depending on the device. Adjust the devices so the charging coils connect properly.
- Some features are not available while sharing power.
 - Only devices that support the wireless charging feature can be charged using this feature. Some devices may not be charged. To check out devices that support the Wireless power sharing feature, visit the Samsung website.
 - To charge properly, do not move or use either device while charging.
 - The power charged to the other device may be less than the amount shared to it by your phone.
 - If you charge the other device while charging your phone, the charging speed may decrease or the device may not charge properly depending on the charger type.
 - The charging speed or efficiency may vary depending on the phone's condition or the surrounding environment.

Setting the limit for power sharing

You can set the device to stop power sharing when the remaining battery power drops below a certain level.



Open **Settings**, tap **Battery** → **Wireless power sharing** → **Battery limit**, and then set the limit.

Reducing the battery consumption

Your device provides various options that help you conserve battery power.

- Optimise the device using the device care feature.
- When you are not using the device, turn off the screen by pressing the Side button.
- Turn on power saving mode.
- Close unnecessary apps.
- Turn off the Bluetooth feature when not in use.
- Turn off auto-syncing of apps that need to be synced.
- Decrease the backlight time.
- Decrease the screen brightness.

Battery charging tips and precautions

-  • Use only Samsung-approved batteries designed for your device.
- Use of Samsung-approved chargers and cables specifically designed for your device is recommended.
-  • Connecting the charger improperly may cause serious damage to the device. Any damage caused by misuse is not covered by the warranty.
- Use of the USB Type-C cable supplied with the device is recommended. Using a Micro USB cable may cause damage to the device.
- If you charge the device while the multipurpose jack is wet, the device may be damaged. Thoroughly dry the multipurpose jack before charging the device.
-  • To save energy, unplug the charger when not in use. The charger does not have a power switch, so you must unplug the charger from the electric socket when not in use to avoid wasting power. The charger should remain close to the electric socket and easily accessible while charging.
- Use of a charger approved by Samsung that guarantees charging performance is recommended.
- If the battery is completely discharged, the device cannot be turned on immediately when the charger is connected. Allow a depleted battery to charge for a few minutes before turning on the device.
- If you use multiple apps at once, network apps, or apps that need a connection to another device, the battery will drain quickly. To avoid losing power during a data transfer, always use these apps after fully charging the battery.
- Using a power source other than the charger, such as a computer, may result in a slower charging speed because of a lower electric current.
- The device can be used while it is charging, but it may take longer to fully charge the battery.
- If the device receives an unstable power supply while charging, the screen may not function. If this happens, unplug the charger from the device.
- While charging, the device and the charger may heat up. This is normal and should not affect the device's lifespan or performance. If the battery gets hotter than usual, the charger may stop charging.
- If the device is not charging properly, take the device and the charger to a Samsung Service Centre or an authorised service centre.

Nano-SIM card and eSIM

Insert the SIM or USIM card or download the eSIM provided by your carrier.

Differing from a physical nano-SIM card, an eSIM is an embedded digital SIM. To have two phone numbers or carriers for a single device, insert another SIM or USIM card or download another eSIM.



- eSIM may not be available depending on the region, carrier, or model.
- Some services that require a network connection may not be available depending on the carrier.
- Using both the nano-SIM card and the eSIM, or two eSIMs may result in slower data transfer speeds in some areas.

Inserting the SIM or USIM card

► Galaxy S24 Ultra:

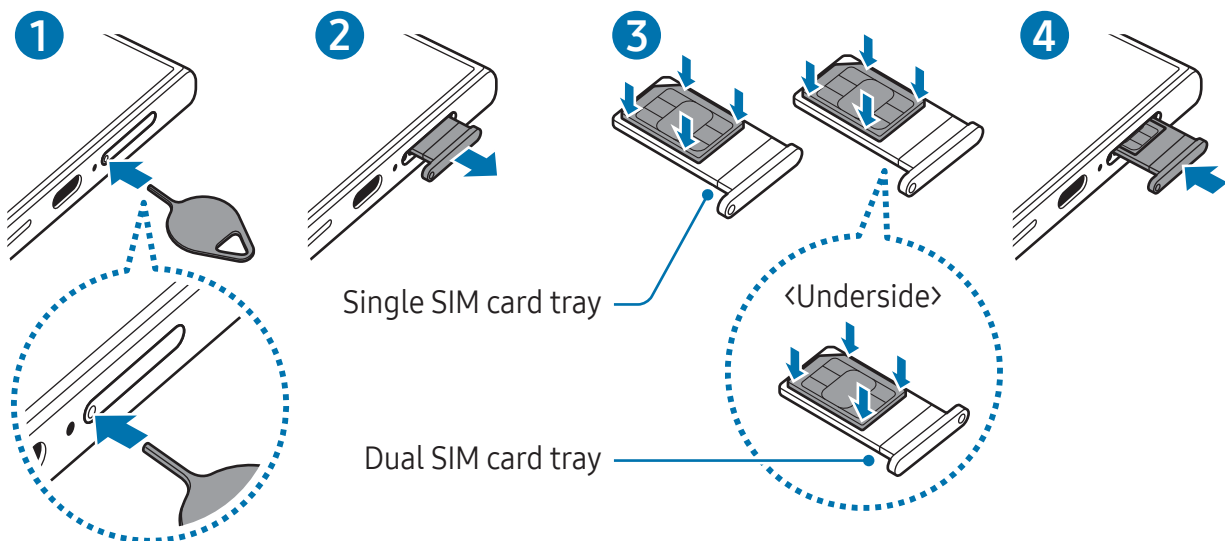

► Galaxy S24+, Galaxy S24:

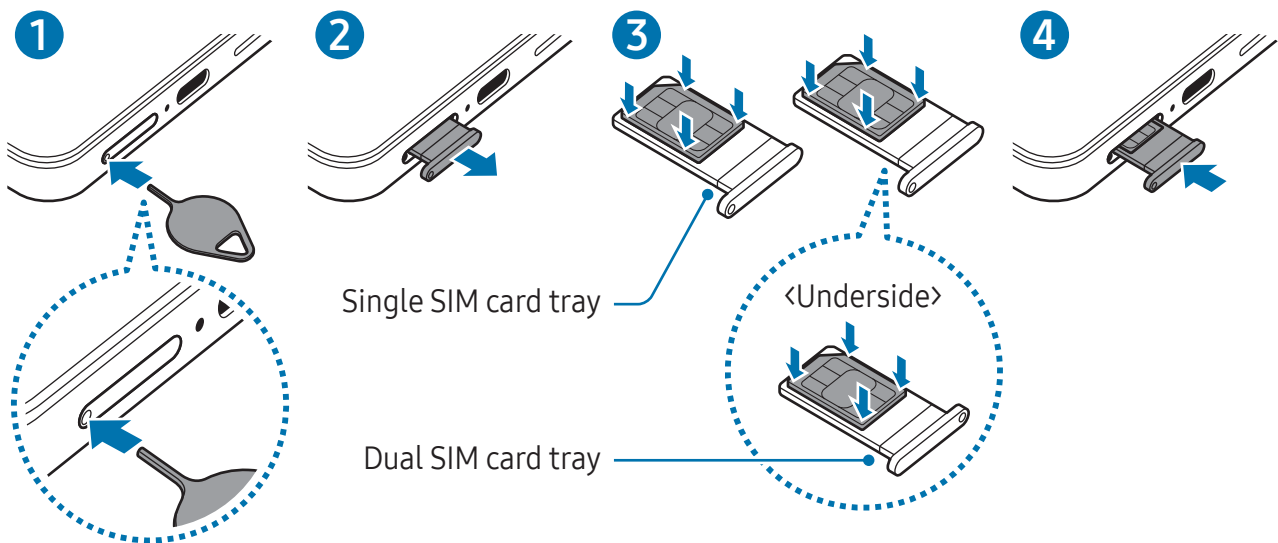

- 1 Insert the ejection pin into the hole on the tray to loosen the tray.
 - 2 Pull out the tray gently from the tray slot.
 - 3 Place the SIM or USIM card on the tray with the gold-coloured contacts facing upwards and gently press the SIM or USIM card into the tray to secure it.
 - 4 Insert the tray back into the tray slot.
- ❗ Insert the ejection pin into **the tray's hole** to remove the tray.
 - Use only a nano-SIM card.
 - Use caution not to lose or let others use the SIM or USIM card. Samsung is not responsible for any damages or inconveniences caused by lost or stolen cards.
 - Ensure that the ejection pin is perpendicular to the hole. Otherwise, the device may be damaged.
 - If the card is not fixed firmly into the tray, the SIM card may leave or fall out of the tray.
 - If you insert the tray into your device while the tray is wet, your device may be damaged. Always make sure the tray is dry.
 - Fully insert the tray into the tray slot to prevent liquid from entering your device.

Downloading an eSIM

Open **Settings**, tap **Connections** → **SIM manager** → **Add eSIM**, and then follow the on-screen instructions to download the eSIM.

If you have a QR code provided by your carrier, open **Settings**, tap **Connections** → **SIM manager** → **Add eSIM** → **Scan QR code**, and then scan the QR code.

SIM manager (dual SIM models)

Open **Settings** and tap **Connections** → **SIM manager**.

- **SIM cards:** Activate the SIM card to use and customise the SIM card settings.
- **eSIMs:** Download or activate the eSIM.
- **Preferred SIMs:** Select to use specific SIM cards for some features, such as voice calls, when two cards are activated.
- **Data switching:** Set the device to use another SIM card for data services if the preferred SIM card cannot connect to the network.



You may incur additional charges when using this feature.

- **More SIM settings:** Customise additional settings.

Turning the device on and off



Follow all posted warnings and directions from authorised personnel in areas where the use of wireless devices is restricted, such as aeroplanes and hospitals.

Turning the device on

Press and hold the Side button for a few seconds to turn on the device.

Turning the device off

- 1 To turn off the device, press and hold the Side button and the Volume Down button simultaneously. Alternatively, open the quick settings panel and tap the Power off icon (🔌).
 - 2 Tap **Power off** → **Power off**.
To restart the device, tap **Restart** → **Restart**.
-  If you want to set the device to turn off when you press and hold the Side button, tap **Side button settings** → **Long press** → **Power off menu**.

Forcing restart

If your device is frozen and unresponsive, press and hold the Side button and the Volume Down button simultaneously for more than 7 seconds to restart it.

Emergency calls and medical information

You can make an emergency call or check the medical information you saved.

Press and hold the Side button and the Volume Down button simultaneously, and then tap **Emergency call** or **Medical info**. Alternatively, open the quick settings panel and tap the Power off icon (🔌) → **Emergency call** or **Medical info**.

-  To manage your medical information and emergency contacts, open **Settings** and tap **Safety and emergency**.

Initial setup

When you turn on your device for the first time or after performing a data reset, follow the on-screen instructions to set up your device.

-  If you do not connect to a Wi-Fi network, you might not be able to set up some device features during the initial setup.

Using networks

You can use networks, such as a Wi-Fi, Bluetooth, NFC, or mobile network.

Open **Settings**, tap **Connections**, and then tap the switch of the desired network to turn it on.

For the mobile network, tap **Data usage** and tap the **Mobile data** switch to turn it on.

When not using the network, tap the switch to turn it off.

 Some features may not be available depending on the model.

Samsung account

Using the Samsung account, you can use a variety of Samsung services that are provided through mobile devices, TVs, and the Samsung website.

To check the list of services that can be used with your Samsung account, visit account.samsung.com.

1 Open **Settings** and tap **Sign in to your Galaxy**.

Alternatively, open **Settings** and tap **Accounts and backup** → **Manage accounts** → **Add account** → **Samsung account**.

2 Sign in to your Samsung account. If you do not have a Samsung account, tap **Forgot password or don't have an account?** → **Create account**.

Finding your ID and resetting your password

If you forget your Samsung account ID or password, tap **Forgot password or don't have an account?** → **Forgot ID** or **Forgot password** on the Samsung account sign-in screen.

You can find your ID or reset your password after you enter the required information.

Signing out of your Samsung account

When you sign out of your Samsung account, your data, such as contacts or events, will also be removed from your device.

- 1 Open **Settings** and tap **Accounts and backup** → **Manage accounts**.
- 2 Tap **Samsung account** → **My profile** and tap **Sign out** at the bottom of the screen.
- 3 Tap **Sign out**, enter your Samsung account password, and then tap **OK**.

Transferring data from your previous device (Smart Switch)

Transfer data from your previous device with the USB cable or wirelessly. You can also transfer data from external storage or computer.

Open **Settings**, tap **Accounts and backup** → **Transfer data for device setup**, and then follow the on-screen instructions to transfer data.

Visit www.samsung.com/smartswitch for details and limitations.

- To transfer data using external storage, tap the External storage icon (📁).
- To check the data that has been transferred, tap the More options icon (⋮) → **Transfer result**.



- This feature may not be supported on some devices or computers.
- Samsung takes copyright seriously. Only transfer content that you own or have the right to transfer.

Understanding the screen

Controlling the screen

- Tapping: Tap the screen.
- Touching and holding: Touch and hold the screen for approximately 2 seconds.
- Dragging: Touch and hold an item and drag it to the target position.
- Double tapping: Double tap the screen.
- Swiping: Swipe upwards, downwards, to the left, or to the right.
- Spreading and pinching: Spread two fingers apart or pinch on the screen.
- ⚠️ • Do not allow the screen to come into contact with other electrical devices. Electrostatic discharges can cause the screen to malfunction.
- To avoid damaging the screen, do not tap it with anything sharp or apply excessive pressure to it with your fingertips or other object.
- It is recommended not to use fixed graphics on part or all of the screen for extended periods. Doing so may result in afterimages (screen burn-in) or ghosting.
- 📏 The device may not recognise touch inputs close to the edges of the screen, which are outside of the touch input area.

Navigation bar (soft buttons)

When you turn on the screen, the soft buttons will appear on the navigation bar at the bottom of the screen. The soft buttons are set to the Recents button, Home button, and Back button by default. The functions of the buttons can change according to the app currently being used or usage environment.

Button	Function
Recents ()	Tap to open the list of recent apps.
Home (○)	<ul style="list-style-type: none"> • Tap to return to the Home screen. • Touch and hold to launch Circle to Search. Tap or draw a circle around an image or text.
Back (<)	Tap to return to the previous screen.

Hiding the navigation bar

Check files or use apps on a wider screen by hiding the navigation bar.

Open **Settings** and tap **Display** → **Navigation bar** → **Swipe gestures**.

Home screen and Apps screen

The Home screen is the starting point for accessing all of the device's features. It displays widgets, shortcuts to apps, and more.

The Apps screen displays icons for all apps, including newly installed apps.

Switching between Home and Apps screens

On the Home screen, swipe upwards to open the Apps screen.

To return to the Home screen, swipe upwards or downwards on the Apps screen.

Alternatively, tap the Home button (○) or the Back button (<).

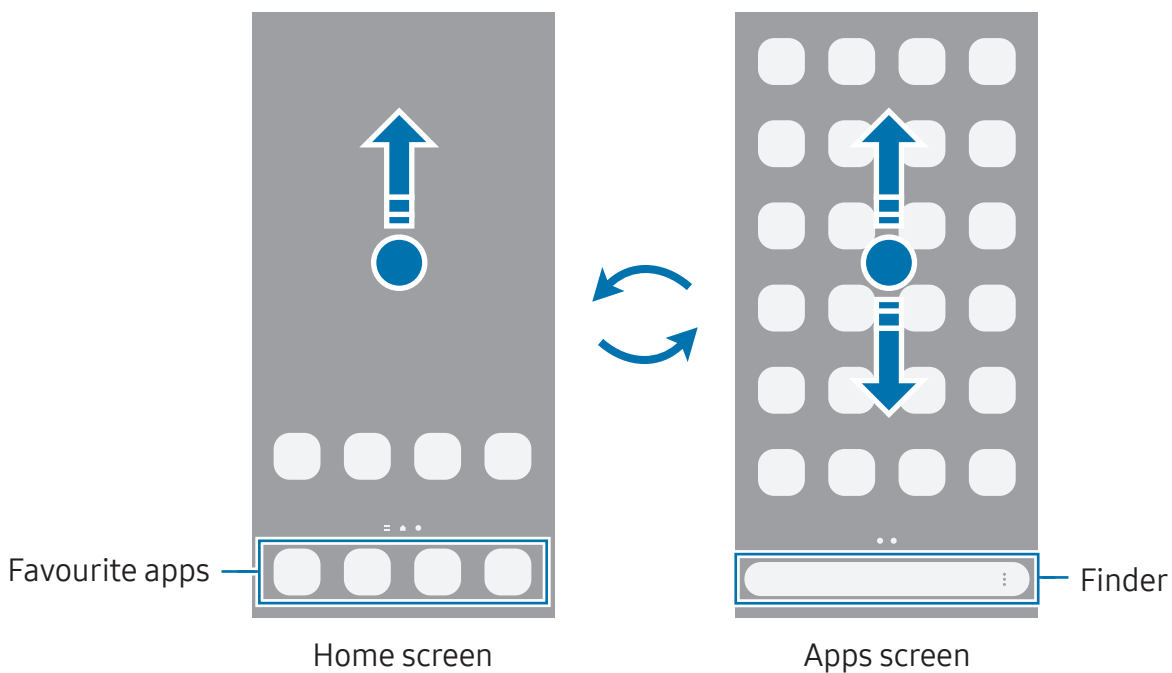

If you add the Apps button on the Home screen, you can open the Apps screen by tapping the button. On the Home screen, touch and hold an empty area, tap **Settings**, and then tap the **Show Apps screen button on Home screen** switch to turn it on. The Apps button (⋮) will be added at the bottom of the Home screen.

Editing the Home screen

On the Home screen, touch and hold an empty area, or pinch your fingers together to access the editing options. You can set the wallpaper, add widgets, and more.

- **Wallpaper and style:** Change the wallpaper settings for the Home screen and the locked screen.
- **Themes:** Change the device's theme. Visual elements of interface, such as colours, icons, and wallpapers, will change depending on the selected theme.
- **Widgets:** Widgets are small apps that launch specific app features to provide information and convenient access on your Home screen. Select a widget and tap **Add**. The widget will be added on the Home screen.
- **Settings:** Configure settings for the Home screen, such as the screen layout.

You can also add, delete, or rearrange Home screen panels.

- Adding panels: Swipe to the left, and then tap the Add page icon (+).
- Moving panels: Drag a panel preview to a new location.
- Deleting panels: Tap the Remove icon (🗑️) on the panel.

Displaying all apps on the Home screen

Without using a separate Apps screen, you can set the device to display all apps on the Home screen. On the Home screen, touch and hold an empty area, and then tap **Settings** → **Home screen layout** → **Home screen only** → **Apply**.

Launching Finder

Search for content on the device.

1 On the Apps screen, tap **Search**.

2 Enter a keyword.

Apps and content on your device will be searched.

If you tap the Search icon (🔍) on the keyboard, you can search for more content.

Moving items

Drag an item to a new location. To move the item to another panel, drag it to the side of the screen. If you touch and hold an item and tap **Select**, you can select more items and move them together at once.

To add a shortcut to an app on the Home screen, touch and hold an item on the Apps screen, and then tap **Add to Home**. A shortcut to the app will be added on the Home screen.

You can also move frequently used apps to the shortcuts area at the bottom of the Home screen.

Creating folders

On the Home screen or the Apps screen, drag an app over another app.

A new folder containing the selected apps will be created. Tap **Folder name** and enter a folder name.

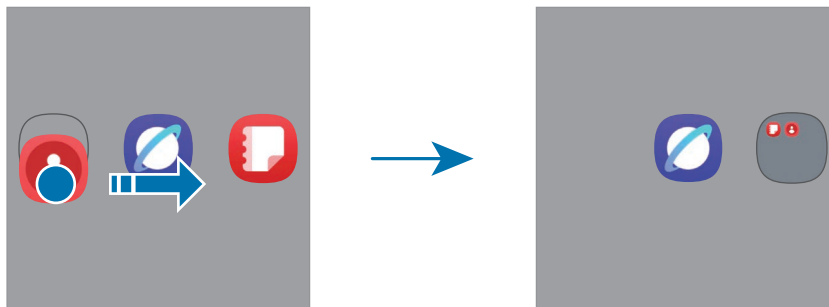

- **Adding more apps**

Tap the Add apps icon (⊕) on the folder. Tick the apps to add and tap **Done**. You can also add an app by dragging it to the folder.

- **Moving apps from a folder**

Drag an app to a new location.

- **Deleting a folder**

Touch and hold a folder, and then tap **Delete**. Only the folder will be deleted. The folder's apps will be relocated to the Apps screen.

Edge panel

You can access your favourite apps and features from the Edge panels.

Drag the Edge panel handle towards the centre of the screen.

If the Edge panel handle is not visible, open **Settings**, tap **Display**, and then tap the **Edge panels** switch to turn it on.

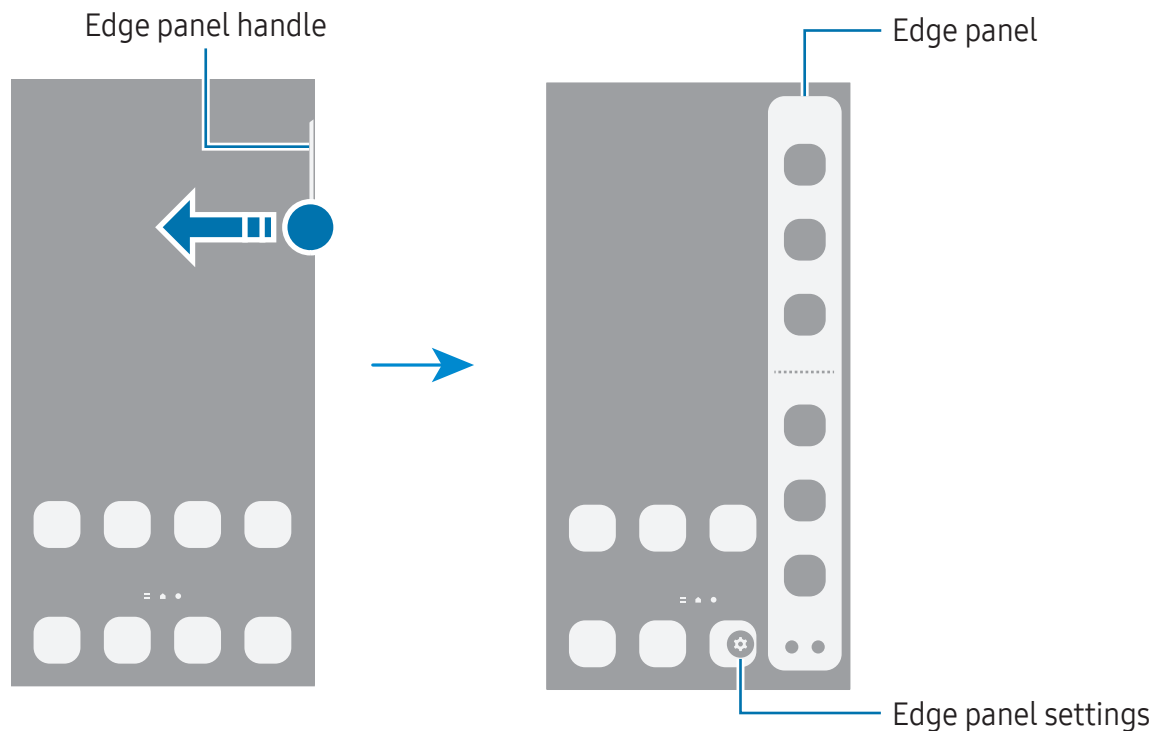

Lock screen

Pressing the Side button turns off the screen and locks it. Also, the screen turns off and automatically locks if the device is not used for a specified period.

To unlock the screen, swipe in any direction when the screen turns on.

If the screen is off or the Always On Display is on, press the Side button or double tap the screen. For more information about the Always On Display, refer to [Always On Display](#).

Editing shortcuts

You can change the shortcuts at the bottom of the locked screen to other apps or features you want.

Touch and hold on the locked screen, tap the shortcut icon, select an app or feature you want, and then tap **Done**.

Changing the screen lock method













To change the screen lock method, open **Settings**, tap **Lock screen and AOD** → **Screen lock and biometrics**, and then select a method.





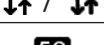





When you set a pattern, PIN, password, or your biometric data for the screen lock method, you can protect your personal information by preventing others from accessing your device. After setting the screen lock method, the device will require an unlock code whenever unlocking it.

-  You can set your device to perform a factory data reset if you enter the unlock code incorrectly several times in a row and reach the attempt limit. Open **Settings**, tap **Lock screen and AOD** → **Secure lock settings**, unlock the screen using the preset screen lock method, and then tap the **Auto factory reset** switch to turn it on.

Indicator icons

Indicator icons appear on the status bar at the top of the screen. The icons listed in the table are most common.

Icon	Meaning
•	New notifications
	No signal
	Signal strength
	Roaming (outside of normal service area)
	GPRS network connected
	EDGE network connected
	UMTS network connected
	HSDPA network connected
	HSPA+ network connected
	LTE network connected
	5G network connected
	LTE network connected in LTE network that includes the 5G network
	Wi-Fi connected
	Bluetooth feature turned on

Icon	Meaning
	S Pen connected/disconnected
	S Pen battery power level
	Location services being used
	Call in progress
	Missed call
	New text or multimedia message
	Alarm turned on
	Mute mode / Vibration mode
	Flight mode turned on
	Error occurred or caution required
	Battery charging / Battery power level



- The status bar may not appear at the top of the screen in some apps. To display the status bar, drag down from the top of the screen.
- Some indicator icons appear only when you open the notification panel.
- Some notifications will be displayed as a dot.
- The indicator icons may appear differently depending on the carrier or model.

Notification panel

When you receive new notifications, indicator icons appear on the status bar. Open the notification panel to check the details.

To open the notification panel, swipe downwards from the top of the screen, except for the right side. To close the notification panel, swipe upwards on the screen.

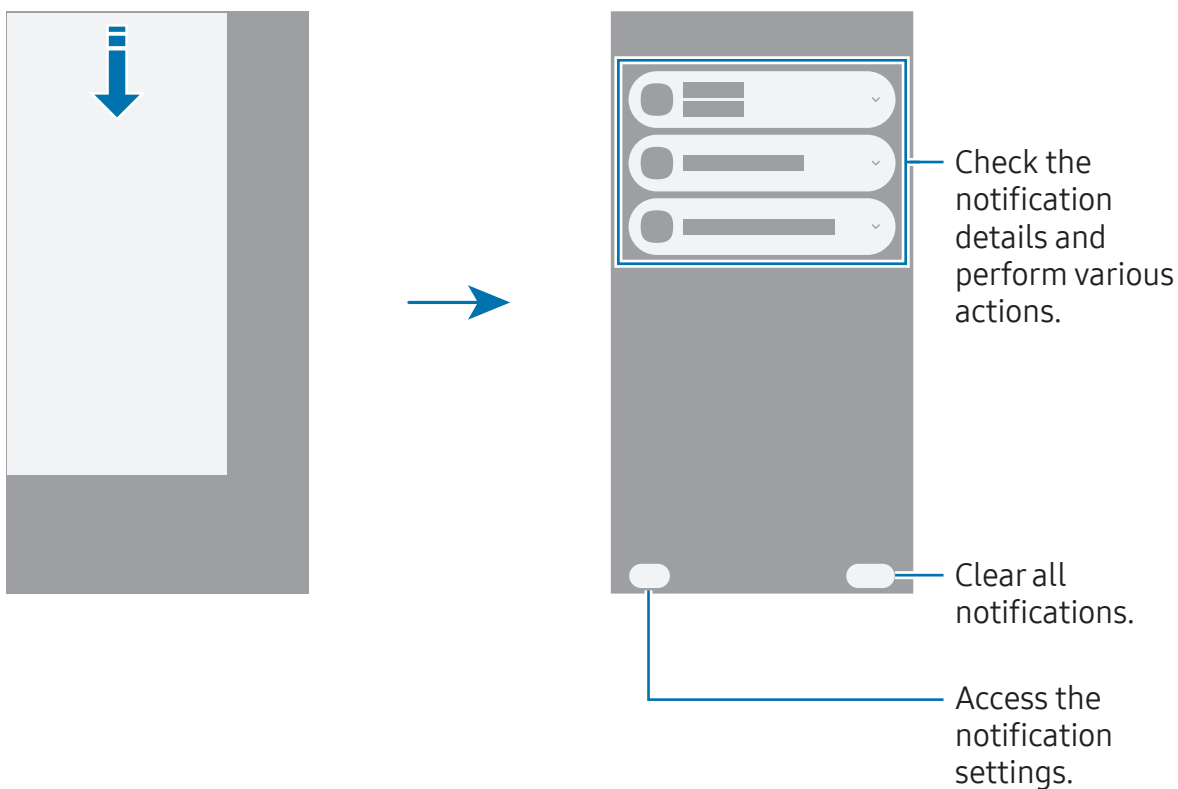

Quick settings panel

You can turn specific features on or off, such as the Wi-Fi or Bluetooth feature, by tapping each button.

To open the quick settings panel, swipe downwards from the top right side of the screen. To close the quick settings panel, swipe upwards on the screen.

To access more detailed settings, touch and hold a button. To edit buttons, tap the Edit icon (✎) → **Edit**.

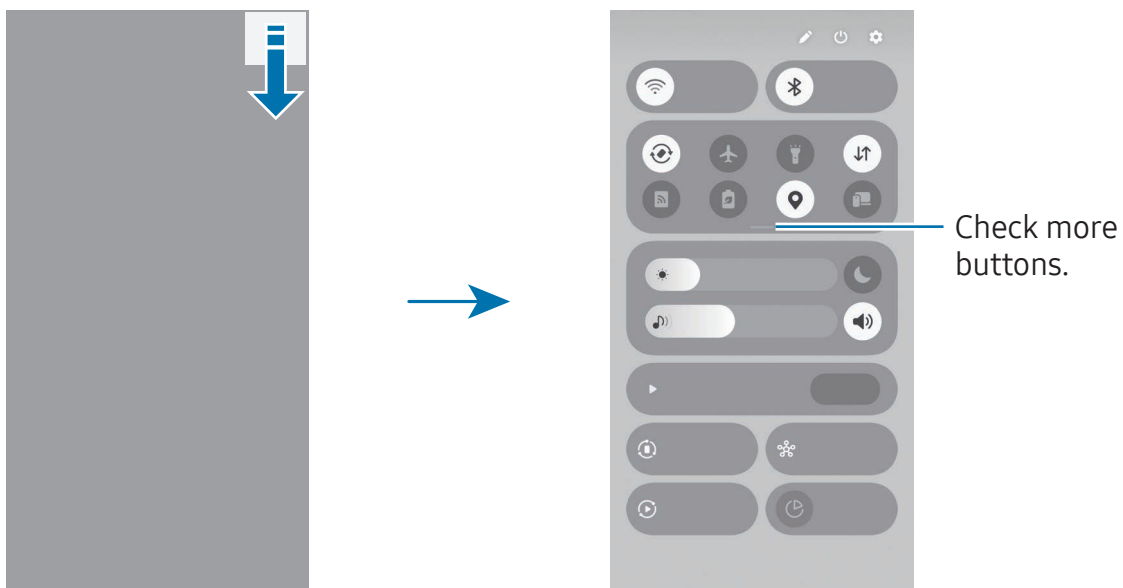

 This image may differ depending on the region or model.

Controlling media playback

Control media on your phone and connected nearby devices on the quick settings panel.

- 1 Open the quick settings panel and tap **Media output**.
- 2 Tap the icons on the controller to control the playback.

Controlling nearby devices

Control nearby connected devices or connect other nearby devices on the quick settings panel.

- 1 Open the quick settings panel and tap **Nearby devices**.
Nearby connected devices will appear with a line connecting them to the circle around your phone.
- 2 Select a nearby device to control it.
 - To connect other nearby devices, drag a device from the panel at the bottom of the screen to the circle.
 - To end the connection, drag the device to the panel at the bottom of the screen.

Controlling frequently used devices

Control devices connected to device control apps, such as SmartThings, and manual routines on the quick settings panel.

- 1 Open the quick settings panel and tap **SmartThings**.
- 2 Tap the switch next to the app you want to turn on and tap **Start**.
Connected devices and manual routines will appear.
- 3 Select a device to control it, or select a manual routine to launch it.

Screen capture and screen record

Screen capture

Capture a screenshot while using the device and write on, draw on, crop, or share the captured screen. You can capture the current screen and scrollable area.

How to capture a screenshot

Use the following methods to capture a screenshot. You can check the captured screenshots in **Gallery**.

- Button capture

Press the Side button and the Volume Down button simultaneously.

- Swipe capture





With the edge of your hand, swipe your hand to the left or right across the screen.



If capturing a screenshot by swiping is not turned on, open **Settings**, tap **Advanced features** → **Motions and gestures**, and then tap the **Palm swipe to capture** switch to turn it on.



It is not possible to capture a screenshot while using some apps and features.







After capturing a screenshot, use the following options on the toolbar at the bottom of the screen:

- : Capture the current content and the hidden content on an elongated page, such as a webpage. When you tap the Scroll capture icon () , the screen will automatically scroll down and more content will be captured.
- : Write or draw on the screenshot or crop a portion from the screenshot. You can check the cropped area in **Gallery**.
- **#**: Add tags to the screenshot. To search for screenshots by tag, open the **Gallery** app and tap the Search icon (**Q**). You can access the tags list and search for the screenshot you want. If the tags list does not appear, tap the More options icon () → **Search settings** → **Search categories** and tap the **My tags** switch to turn it on.

- : Share the screenshot with others.
 - : Select an area and perform actions, such as sharing or saving. Tap or draw a circle around the content you want to select. Then, select an option to use with the selected area.
-  If the options are not visible on the captured screen, open **Settings**, tap **Advanced features** → **Screenshots and screen recordings**, and then tap the **Show toolbar after capturing** switch to turn it on.

Screen record

Record the screen while using your device.

- 1 Open the quick settings panel, tap the Expand icon (—), and then tap **Screen recorder** () .
 - 2 Select a sound setting and tap **Start recording**.
After a countdown, recording will start.
 - To write or draw on the screen, tap the Draw icon () .
 - To show the S Pen pointer on the screen, tap the Pointer icon () . You can use this feature only when the S Pen is detached from the device. (Galaxy S24 Ultra)
 - To record the screen with a video overlay of yourself, tap the Selfie video icon () .
 - 3 When you are finished recording the video, tap the Stop icon () .
You can check the video in **Gallery**.
-  To change the screen recorder settings, open **Settings** and tap **Advanced features** → **Screenshots and screen recordings**.

Entering text

Keyboard layout

A keyboard appears automatically when you enter text.

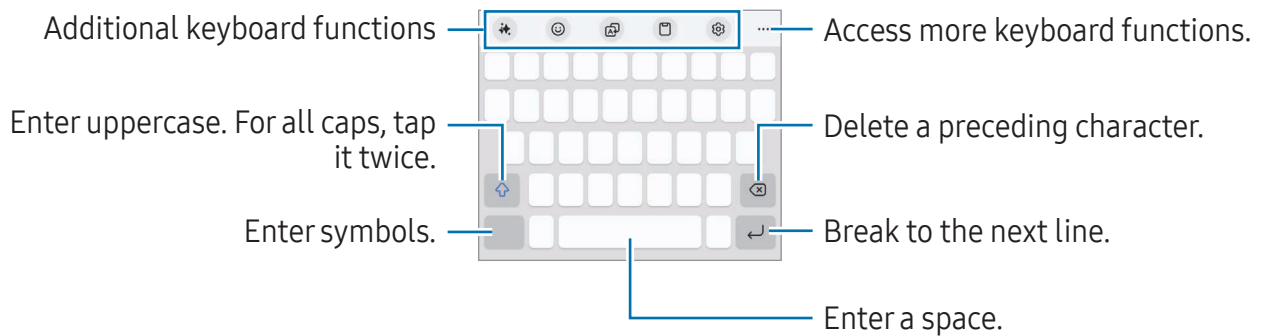

 Text entry is not supported in some languages. To enter text, you must change the input language to one of the supported languages.

Changing the input language

Tap the Settings icon (⚙️) → **Languages and types** → **Manage input languages** and select the languages to use. When you select two or more languages, you can switch between the input languages by tapping the Change language icon (🌐).



To change the keyboard type, tap the Settings icon (⚙️) → **Languages and types**, select a language, and then select the keyboard type you want.

 On a **3 x 4** keyboard, a key has three or four characters. To enter a character, tap the corresponding key repeatedly until the desired character appears.

Using the keyboard button



You can change the text input method by tapping the keyboard button on the navigation bar.

To change the keyboard button on the navigation bar, touch and hold the keyboard button and select an option you want.

-  : Enter text by voice.
-  : Change the keyboard.



 If the keyboard button does not appear on the navigation bar, open **Settings**, tap **General management** → **Keyboard list and default**, and then tap the **Keyboard button on navigation bar** switch to turn it on.

Copying and pasting

- 1 Touch and hold over text.
- 2 Drag the Left text selection icon () or the Right text selection icon () to select the desired text, or tap **Select all** to select all text.
- 3 Tap **Copy** or **Cut**.
The selected text is copied to the clipboard.
- 4 Touch and hold where the text is to be inserted and tap **Paste**.

Extracting text

While using some apps, such as the **Gallery** or **Camera** app, you can extract text from images and use options, such as copying or sharing it. The following actions are an example of extracting text in the **Gallery** app.

- 1 While checking an image in the **Gallery** app, tap the Extract text icon ().
The Extract text icon () appears only when there is text to extract.
- 2 Select an area to extract text.
- 3 Select an option you want.

Apps and features

Introduction

Use apps and various features of the device.

This chapter is a common guide for apps and features provided by Samsung devices. Depending on the model, some content may differ, or descriptions of apps or features not available on your device may be included.





Installing or uninstalling apps

Galaxy Store

Purchase and download apps. You can download apps that are specialised for Samsung Galaxy devices.

Open the **Store** app. Browse apps by category or tap the Search icon (Q) to search for a keyword.

-  This app may not be available depending on the carrier or model.
-  To change the auto update settings, tap **Menu** → the Settings icon (⚙️) → **Auto update apps**, and then select an option.

Play Store

Purchase and download apps.

Open the **Play Store** app. Browse apps by category or search for apps by keyword.

-  To change the auto update settings, tap your account icon, tap **Settings** → **Network preferences** → **Auto-update apps**, and then select an option.

Managing apps

Uninstalling or disabling apps

Touch and hold an app and select an option.

- **Uninstall:** Uninstall downloaded apps.
- **Disable:** Disable selected default apps that cannot be uninstalled from the device.

-  Some apps may not support this feature.

Enabling apps

Open **Settings**, tap **Apps** → the Sort icon (≡) → **Disabled** → **OK**, select an app, and then tap **Enable**.

Setting app permissions

For some apps to operate properly, they may need permission to access or use information on your device.

To access your app permission settings, open **Settings** and tap **Apps**. Select an app and tap **Permissions**. You can check the app's permissions list and change its permissions.

To check or change app permission settings by permission category, open **Settings** and tap **Apps** → the More options icon (⋮) → **Permission manager**. Select an item and select an app.

 If you do not grant permissions to apps, the basic features of the apps may not function properly.

Galaxy AI

Introduction

Use advanced intelligence features to help you use your device.



- Some features may not be available depending on the region, carrier, or model.
- If you want data processed only within your device to strengthen the protection of your personal information, open **Settings**, tap **Galaxy AI**, and then tap the **Process data only on device** switch to turn it on. Some features require online processing for better results and data processing.

Enhancing your communication

Translating phone calls in real time (Call assist)

Get real-time translation into the language you select during voice calls.

To use this feature, open the **Phone** app, tap the More options icon (⋮) → **Settings** → **Live translate**, tap the switch to turn it on, and then select the languages to use.

When making or receiving a voice call, tap **Call assist** → **Live translate**. To stop translating, tap the Stop translating icon (⏏).

To change additional settings, open the **Phone** app and tap the More options icon (⋮) → **Settings** → **Live translate**.

Translating messages in message apps (Writing assist)

You can translate text messages in message apps.

- 1 While checking or composing a message, tap the Assist icon (✎) on the Samsung Keyboard and tap **Chat translation**.
- 2 Select the languages on the translator panel at the top of the screen. Translations will be displayed under each message.

Changing the writing style (Writing assist)

You can change the writing style, receive spelling and grammar suggestions, and also generate text automatically on a topic you describe.

While composing a message, tap the Assist icon () on the Samsung Keyboard and select an option you want.

- **Spelling and grammar:** Get spelling and grammar suggestions.
- **Writing style:** Change the writing style.
- **Composer:** When you enter the topic you want the device to write about, the device will compose sentences in whatever style you select.



Translating conversations (Interpreter)

Get live translation of your conversations and output it into speech or text.

- 1 Drag the Edge panel handle towards the centre of the screen and tap **Interpreter**.
- 2 Select your language and the other party's language.
If the language you want is not on the list, tap **Add languages** and download the language pack.
- 3 Tap the Microphone icon () and start conversing.

Using voice interpretation (Interpreter)

Get live translation of lectures, meetings, and more.

- 1 Drag the Edge panel handle towards the centre of the screen and tap **Interpreter**.
- 2 Tap the Navigation drawer icon () → **Listening mode**.
- 3 Select the languages on the translator panel at the top of the screen.
- 4 Tap the Microphone icon () to start translating.

Unleashing your productivity

Using Note assist features (Samsung Notes)

Auto format or summarise notes, correct spelling errors, or translate notes. You can also generate new art from your drawing using the Sketch to image feature.

Open the **Notes** app, create a note, tap the Assist icon (✦) on the toolbar, and then select an option you want.

Converting voice recordings to text (Samsung Notes)

You can convert voice recordings you inserted in notes on the **Samsung Notes** app to text.

Open the **Notes** app, select a note that includes a voice recording, tap the Assist icon (✦) on the toolbar, and then tap **Transcribe**.

Summarising and translating voice recordings (Voice Recorder)

Convert voice recordings into on-screen text and check summaries. You can also translate the converted text into other languages.

- 1 Open the **Voice Recorder** app.
- 2 Select a voice recording.
- 3 Tap **Transcribe**.
 - To check the keywords and summary, tap **Summary**.
 - To translate the converted text, tap the Translation icon (A) and select a language.
 - To transcribe the recording into another language, tap the More options icon (⋮) → **Transcribe again**.
 - To edit the converted text, tap the More options icon (⋮) → **Edit transcript text**.

Summarising and converting call recordings into text (Transcript assist)

You can record a call and convert the recorded call into a text transcript and summarise it.

- 1 Open the **Phone** app, tap the More options icon (⋮) → **Settings** → **Record calls** → **Transcript assist**, and then tap the **Auto transcribe recorded calls** switch to turn it on.
- 2 Tap **Transcription language** and select a language to use.
- 3 During a voice call, tap the Record icon (📞) to record the conversation.
- 4 Open the **Phone** app, tap **Recents**, and then select a recorded call with a transcript. The Call recording icon (📞) will be displayed next to calls with recordings.
- 5 Tap **View recording and transcript** and check the converted transcripts. To summarise the transcripts, tap **Summarise**.

Translating or summarising webpages (Browsing assist)

Get simple summaries of text from webpages along with full translations. You can also set the device to read the webpage's highlights aloud.

Open the **Internet** app, tap the Assist icon (🔗), and then select an option you want.

Translating text using the camera (Camera)

You can translate text using the camera.

- 1 Open the **Camera** app and tap **PHOTO** on the shooting modes list.
- 2 Point the camera towards the object and tap the Scan documents and text icon (📄). The Scan documents and text icon (📄) will only appear when a document or text is detected.
- 3 Tap **Translate**.
The text will be translated into the current device language.

Circle to Search

Search for information about the desired part of the image or text on the screen.

Touch and hold the Home button (○) and tap or draw a circle around an image or text.

Creating epic images

Editing images with the Photo assist (Gallery)

Edit images by moving, removing, or resizing people or objects in them and then generate a new background to fill in any missing pieces.

- 1 Open the **Gallery** app and select an image.
- 2 Tap the Assist icon (🔮).
- 3 Tap or draw around anything you want to delete or move.
If you want to adjust the tilt, drag the tilt adjustment bar.
- 4 Touch and hold the selected area and drag it to where you want or tap the Remove icon (🗑️) to delete it.
- 5 Tap **Generate**.
- 6 Tap **Save copy** to save the image.

Adding objects on an image by drawing (Gallery)

You can add objects on images by drawing.

- 1 Open the **Gallery** app and select an image.
- 2 Tap the Assist icon (🔮) → the Sketch to image icon (🎨).
- 3 Draw objects on the image.
To change the pen colour or thickness, tap the Basic pen icon (🖋️).
- 4 Tap **Generate**.
- 5 Select a result you want and tap **Save copy** to save the image.

Generating new portraits (Gallery)

You can generate various new portraits, such as 3D cartoon portraits, from images.

- 1 Open the **Gallery** app and select an image.
- 2 Tap the Assist icon (🔮) → **Portrait studio**.
- 3 Select a style you want and tap **Generate**.
- 4 Select a result you want and tap **Save copy** to save the image.

Making stereoscopic images (Gallery)

You can apply the stereoscopic effect to images of people or pets (cats and dogs).

- 1 Open the **Gallery** app and select an image.
- 2 Swipe upwards on the screen and tap **Live effect**.
- 3 Tap the Save icon (↓) to save the file.



Using the Instant slow-mo feature (Gallery)

You can play a selected part of the video in slow motion and check more details by touching and holding that part.

- 1 Open the **Gallery** app and select a video to play.
 - 2 While playing the video, touch and hold the screen.
-  This feature may not be available depending on the file.

Using the Drawing assist feature

Generate new art from your drawing, text descriptions, or an image you select.

- 1 Drag the Edge panel handle towards the centre of the screen and tap **Drawing assist**. Alternatively, tap **Drawing assist** on the Air command panel. (Galaxy S24 Ultra)
- 2 Select an option you want.
 -  : Draw on the screen.
 -  : Select an image you want.
 -  : Describe what you want to create in text.
- 3 Select an image style and tap **Generate**.
- 4 Tap the Save icon (↓) to save the image. To save the image as a sticker, tap the Save as sticker icon (😊). You can use the stickers on the Samsung Keyboard.

Using the AI select feature

Select an area on the screen and use various intelligent features.

- 1 Drag the Edge panel handle towards the centre of the screen and tap **AI select**.
Alternatively, tap **AI select** on the Air command panel. (Galaxy S24 Ultra)
- 2 Tap or draw a circle around the content you want to select.
- 3 Select an option to use with the selected area.

Creating your own wallpapers

Create wallpapers by selecting categories and keywords or automatically change the locked screen wallpaper based on the time and weather.

- 1 Open **Settings** and tap **Wallpaper and style**.
- 2 Tap **Change wallpapers** → **Create with AI** and select an option you want.
 - **Generative**: Generate new wallpapers with categories and keywords you select.
 - **Photo ambient**: Change the locked screen wallpaper automatically based on the weather and time.

Generating a new profile card (Contacts)

You can change your profile card by generating new portraits.

- 1 Open the **Contacts** app and tap your profile.
- 2 Tap your profile card and tap **Edit profile card** → **Change image**.
- 3 Select a portrait image you want and tap **Portrait studio**.
- 4 Select a style you want and tap **Generate**.
- 5 Select a result you want and tap **Apply** → **Done**.

S Pen (Galaxy S24 Ultra)

Using the S Pen

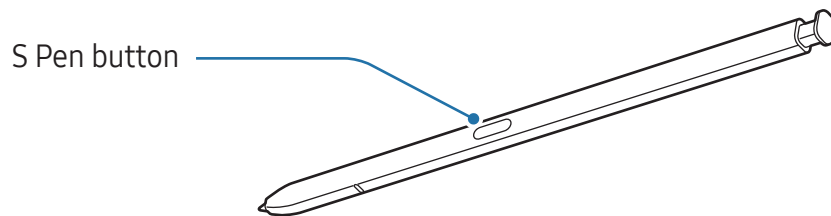

- ⚠ • Do not bend or apply excessive pressure with the S Pen while using it. The S Pen may be damaged or the nib may be deformed.
- Do not hard press on the screen with the S Pen. The pen nib may be deformed.
- 📌 • If there is a magnet near the device, some S Pen actions, such as charging or tapping the screen, may not work.
- Even if the S Pen has been fully discharged, you can use other S Pen features, such as tapping the screen or the Air command features.
- If you use the S Pen at sharp angles on the screen, the device may not recognise the S Pen actions.
- If water enters the S Pen slot, remove the water from the slot before using it.
- If the S Pen is not working properly, take it to a Samsung Service Centre or an authorised service centre.

Detaching the S Pen

Press the end of the S Pen to disengage it. Then, pull the S Pen from the slot. To store the S Pen, reinsert it into the slot and push it until it clicks into place.

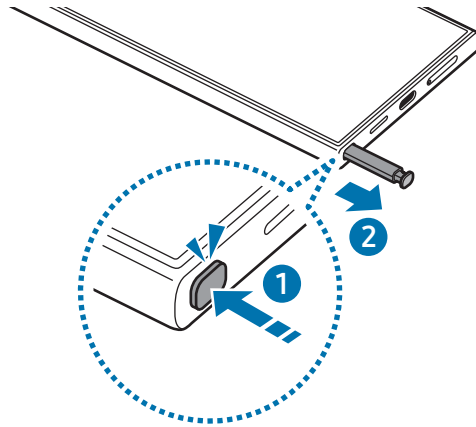

-  If you want to set an action to perform when you detach the S Pen, open **Settings**, tap **Advanced features** → **S Pen** → **When S Pen is removed**, and then select an option.

Charging the S Pen

The S Pen must be charged before you can control apps remotely by using the S Pen button.

When you insert the S Pen into the slot, charging will start.

If the Air action feature is turned off, the S Pen will be charged only when the device is charging.

Allow multiple S Pens

Open **Settings** and tap **Advanced features** → **S Pen** → **More S Pen settings**. Tap the **Allow multiple S Pens** switch to turn it on.

Air actions

(Controlling apps remotely with the S Pen)

Control apps remotely by using the S Pen connected to your device through Bluetooth Low Energy (BLE).

For example, you can open apps, such as the camera app, by pressing and holding the S Pen button. Also, while using the camera app, you can take a picture by pressing the button once. While playing music, you can turn the volume up if you lift the S Pen up while pressing and holding the S Pen button and turn the volume down if you lower it.



- The S Pen must be charged before you can use the Air actions feature. Refer to [Charging the S Pen](#) for more information.
- When you detach the S Pen from the slot, the S Pen icon (🖋️) will appear on the status bar. If the S Pen is discharged or far from the device, or if there are obstacles or there is external interference between the S Pen and the device, the S Pen will be disconnected from the device and the icon will turn grey (🖋️). To use the Air actions feature again, connect the S Pen with the device by reinserting the S Pen into the slot.

Taking pictures with the S Pen

Even though you take pictures with your device placing for a distance, you can take pictures by pressing the S Pen button without setting a timer.

- 1 Open **Settings**, tap **Advanced features** → **S Pen** → **Air actions**, and then tap the switch to turn on the feature.
- 2 Open the **Camera** app.
- 3 Press the S Pen button once to take a picture.
 - To take a series of pictures, press and hold the S Pen button.
 - To change the shooting mode, move the S Pen to the left or right while pressing and holding the S Pen button.
 - To switch between cameras, move the S Pen up or down while pressing and holding the S Pen button.

Changing apps or features to use

Change the app, feature, or actions you want to use with the S Pen feature. Open **Settings**, tap **Advanced features** → **S Pen** → **Air actions**.

Resetting your S Pen

If the S Pen has connection problems or the S Pen disconnects often, reset the S Pen and connect it again.

Insert the S Pen into the slot. Then, open **Settings** and tap **Advanced features** → **S Pen** → the More options icon (⋮) → **Reset S Pen**.



- You can only connect Samsung-approved S Pens that support Bluetooth Low Energy (BLE).
- Do not detach the S Pen from the device when it is being connected. Doing so will interrupt the process.

Air command

(Launching S Pen features and apps directly)

Air command is a menu that provides S Pen features and direct access to frequently used apps.

Tap the Air command icon (🖋️) with the S Pen to open the Air command panel and select a function or app you want.

While using apps that support the Air actions feature, you can check out the available actions of each app by hovering the S Pen over the Air command icon.

To move the Air command icon (🖋️), drag the Air command icon (🖋️) to a new location. To remove the icon, drag the Air command icon (🖋️) to **Remove** at the bottom of the screen.



If the Air command icon does not appear on the screen, open **Settings**, tap **Advanced features** → **S Pen** → **Air command**, and then tap the **Show Air command icon** switch to turn it on. If you turn on the **Open Air command with Pen button** switch, you can open the Air command panel by hovering the S Pen over the screen and pressing the S Pen button.

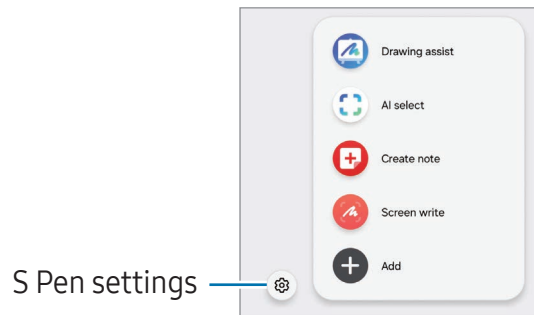

- **Drawing assist:** Generate new art from your drawing, text descriptions, or an image you select. Refer to [Using the Drawing assist feature](#) for more information.
- **AI select:** Use the S Pen to select an area and perform actions, such as sharing or saving. Refer to [AI select](#) for more information.
- **Create note:** Create notes in a pop-up window. You can also launch this feature by double tapping the screen while pressing and holding the S Pen button. Refer to [Samsung Notes](#) for more information.
- **Screen write:** Capture screenshots to write or draw on them or crop an area from the captured image. You can also capture the current content and the hidden content on an elongated page, such as a webpage. Refer to [Screen write](#) for more information.
- **Translate:** Hover the S Pen over a word to translate it. Refer to [Translate](#) for more information.
- **Magnify:** Hover the S Pen over an area of the screen to enlarge it.
- **PENUP:** Post your artwork, check out others' artwork, and get useful drawing tips.
- **Write on calendar:** Open the **Calendar** app and write or draw on the screen. Refer to [Write on calendar](#) for more information.
- **Add:** Add shortcuts to frequently used apps to the Air command panel.

AI select

Use the S Pen to select an area and perform actions, such as sharing or saving.

- 1 When there is content you want to capture, such as a part of an image, open the Air command panel and tap **AI select**.
- 2 Tap or draw a circle around the content you want to select.
- 3 Select an option to use with the selected area.

Screen write

Capture screenshots to write or draw on them or crop an area from the captured image.

- 1 When there is content you want to capture, open the Air command panel and tap **Screen write**.

The current screen is automatically captured and the editing toolbar appears.

- 2 Write a memo on the screenshot.

- 3 Share or save the screenshot.

You can check the captured screenshots in **Gallery**.



It is not possible to capture a screenshot while using some apps.

Translate

Hover the S Pen over the text you want to translate. The units included in the text will also be converted.

- 1 When there is text you want to translate, open the Air command panel and tap **Translate**.

- 2 Select the languages on the translator panel at the top of the screen.

You can change the text between words and sentences by tapping the Sentence icon (☰) or the Word icon (Ⓘ).

- 3 Hover the S Pen over the text you want to translate or the unit you want to convert. The translated text will appear. To listen to the pronunciation of the original text, tap the Play icon (▶). The Play icon (▶) may not appear depending on the language you select.

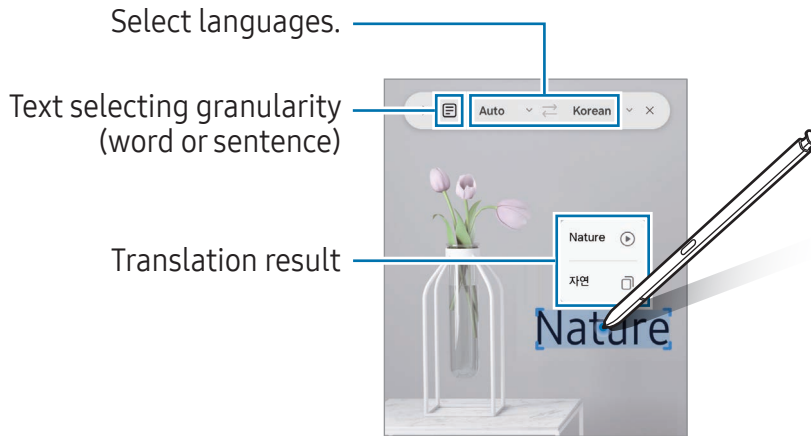

- This feature does not support some languages.
- This feature is available only when detectable text is on the screen.

Write on calendar

Fill in your plans by writing or drawing on the calendar screen.

Open the Air command panel, tap **Write on calendar**, and then fill in your plans on the calendar. When you are finished, tap **Save**.

S Pen to text

You can set the device to convert anything you write with the S Pen into text.

- 1 Open **Settings**, tap **Advanced features** → **S Pen** → **S Pen to text**, and then tap the switch to turn it on.

To learn about how to edit text with the S Pen, tap **How to edit**.

- 2 Write in a text input field, such as a search field or address bar, using the S Pen. The handwriting will be converted to text.

Airview

Hover the S Pen over an item on the screen to preview content or access information in a pop-up window.

In some apps, Action buttons will be displayed on the preview window.

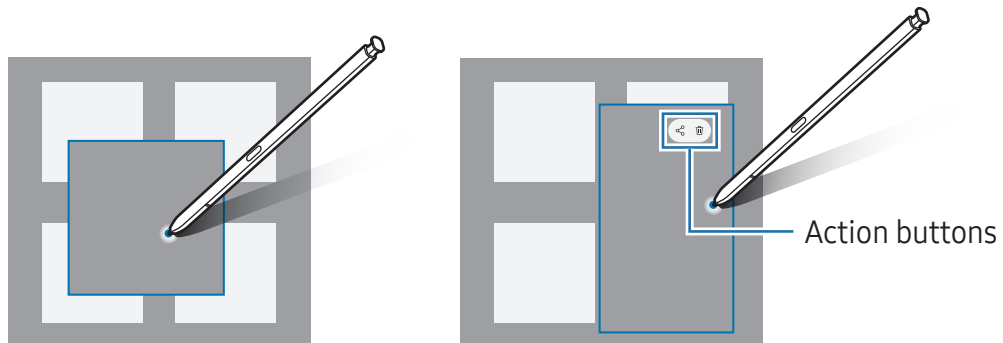

-  If this feature is not turned on, open **Settings**, tap **Advanced features** → **S Pen**, and then tap the **Airview** switch to turn it on.

Pen Select

(Selecting items quickly with the S Pen)

While pressing and holding the S Pen button, drag the S Pen over text or item lists to select multiple items or text. You can also copy and paste the selected items or text into another app or share them with others.

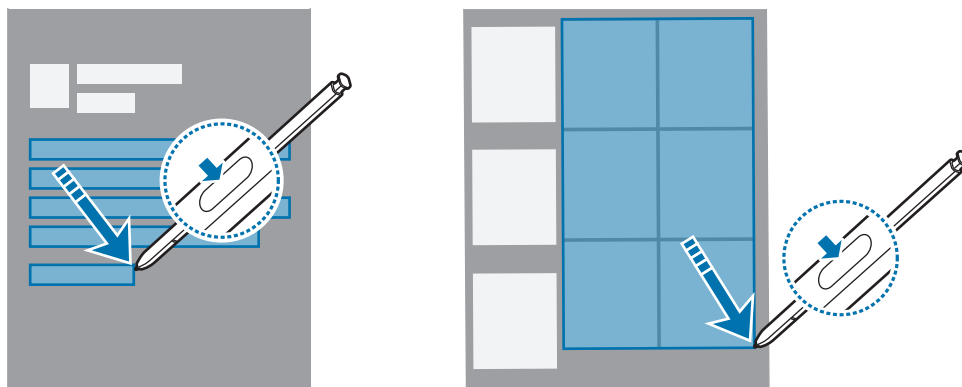

Screen off memos

You can create memos by writing on the screen without turning on it.

When the screen is off, detach the S Pen or double tap the screen while pressing and holding the S Pen button.

When you tap **Save** or reinsert the S Pen into the slot after writing a memo, the memo will be saved to **Samsung Notes**.

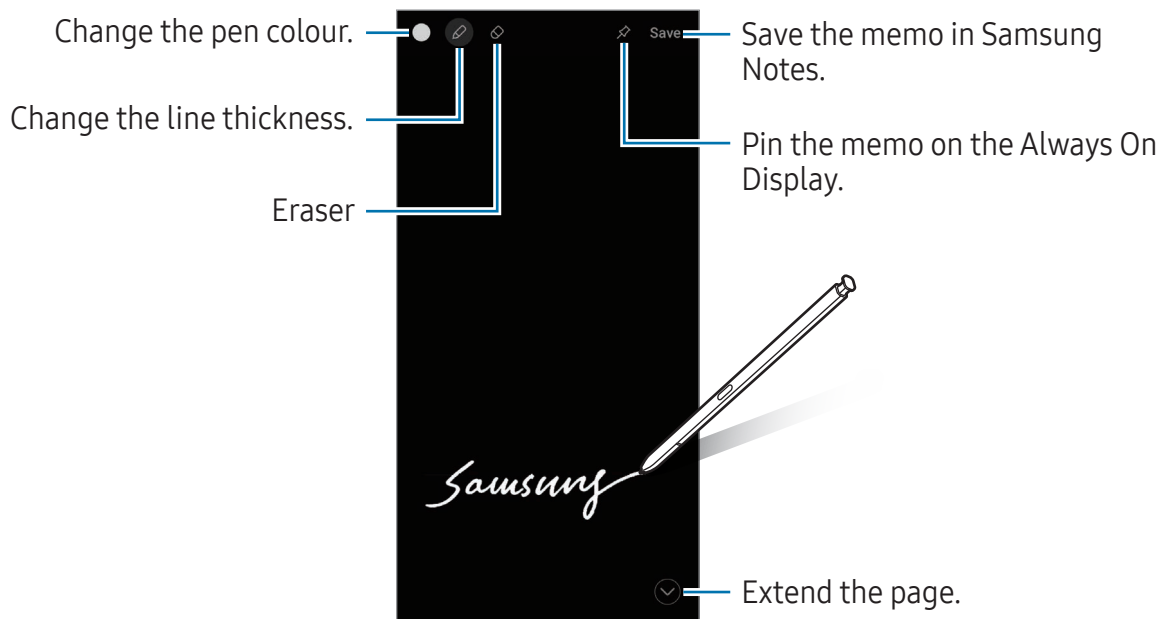

 If this feature is not turned on, open **Settings**, tap **Advanced features** → **S Pen**, and then tap the **Screen off memos** switch to turn it on.

Pinning a memo on the Always On Display

To pin a screen off memo on the Always On Display, tap the Pin to Always On Display icon (📌). The pinned memo will not be saved yet.

To edit the pinned memo, double tap the Edit icon (✎). If you pin the edited memo on the Always On Display again, the original memo will be saved to **Samsung Notes**.

To minimise the pinned memo, double tap the Minimise icon (↩). The memo will be displayed as the Pinned memo icon (📌) on the Always On Display. To check out the memo again, double tap the Pinned memo icon (📌).

 If you do not perform any actions for a certain period after opening a memo, the memo will be automatically minimised.

Unlocking the screen using the S Pen

If the screen is locked while the S Pen is connected, you can unlock the screen by pressing the S Pen button.

- 1 Open **Settings** and tap **Advanced features** → **S Pen** → **More S Pen settings**.
- 2 Tap the **S Pen unlock** switch to turn it on.

Now you can unlock the screen by pressing the S Pen button.



-  • The **S Pen unlock** feature is available only when the screen lock method is set.
- To use this feature, the S Pen must be connected to your device.

Phone

Introduction

Make or answer voice and video calls.

Making calls

- 1 Open the **Phone** app and tap **Keypad**.
- 2 Enter a phone number.
- 3 Tap the Voice call icon () to make a voice call, or tap the Video call icon () or the Meet video call icon () to make a video call.

Making calls from call logs or contacts list

Open the **Phone** app, tap **Recents** or **Contacts**, and then swipe to the right on a contact or a phone number to make a call.

If this feature is turned off, tap the More options icon () → **Settings** → **Other call settings**, and then tap the **Swipe to call or text** switch to turn it on.

Using speed dial

To set a number to speed dial, open the **Phone** app, tap **Keypad** → the More options icon () → **Speed dial numbers**, select a speed dial number, and then add a phone number.

To make a call, touch and hold a speed dial number on the keypad. For speed dial numbers 10 and up, tap the first digit(s) of the number, and then touch and hold the last digit.

For example, if you set the number **123** as a speed dial number, tap **1**, tap **2**, and then touch and hold **3**.

Making an international call

- 1 Open the **Phone** app and tap **Keypad**.
- 2 Touch and hold **0** until the + sign appears.
- 3 Enter the country code, area code, and phone number, and then tap the Call icon ()

Receiving calls



Answering a call

When a call comes in, drag the Answer icon () outside the large circle.

Rejecting a call

When a call comes in, drag the Decline icon () outside the large circle.

To send a message when rejecting an incoming call, drag the **Send message** bar upwards and select a message to send.

To create various rejection messages, open the **Phone** app, tap the More options icon () → **Settings** → **Quick decline messages**, enter a message, and then tap the Add icon ()

Blocking phone numbers

Block calls from specific numbers added to your block list.

Open the **Phone** app, tap the More options icon () → **Settings** → **Block numbers**, and then select contacts or phone numbers to save in the blocked numbers list.

When blocked numbers try to contact you, you will not receive notifications. The calls will be logged in the call log.

-  You can also block incoming calls from people that do not show their caller ID. Tap the **Block calls from unknown numbers** switch to turn the feature on.

Call assist

Text call

Communicate with the other party through text.

To use this feature, open the **Phone** app, tap the More options icon (⋮) → **Settings** → **Text call**, and then tap the switch to turn it on. When making or receiving a voice call, tap **Call assist** → **Text call**.

When the call is connected, a voice greeting is automatically delivered to the other party and what the other party says is displayed as text on your screen.

If you select a response from the quick response list or enter text, it will be transmitted through a voice to the other party.

To switch to a voice call, tap the Switch to voice call icon (↩).

To change the settings, open the **Phone** app and tap the More options icon (⋮) → **Settings** → **Text call**.

Live translate

Get real-time translation into the language you select during voice calls. Refer to [Translating phone calls in real time \(Call assist\)](#) for more information.

Contacts

Introduction

Create new contacts or manage contacts on the device.

Adding contacts

Creating a new contact

- 1 Open the **Contacts** app and tap the Create icon (+).
- 2 Select a storage location.
- 3 Enter contact information and tap **Save**.

Importing contacts

Add contacts by importing them from other storages to your device.

- 1 Open the **Contacts** app and tap the More options icon (⋮) → **Settings** → **Import contacts**.
- 2 Follow the on-screen instructions to import contacts.

Syncing contacts with your web accounts

Sync your device contacts with online contacts saved in your web accounts, such as your Samsung account.

- 1 Open **Settings**, tap **Accounts and backup** → **Manage accounts** and select the account to sync with.
- 2 Tap **Sync account** and tap the **Contacts** switch to turn it on.

Searching for contacts

Open the **Contacts** app. Tap the Search icon (🔍) at the top of the contacts list and enter search criteria.

Tap the contact. Then take one of the following actions:

- 📞 : Make a voice call.
- 💬 : Compose a message.
- 📺 / 📹 : Make a video call.
- ✉️ : Compose an email.

Deleting contacts

- 1 Open the **Contacts** app and tap the More options icon (⋮) → **Select**.
- 2 Select contacts and tap **Delete**.

To delete contacts one by one, tap a contact from the contacts list and tap **More** → **Delete**.

Sharing contacts

You can share contacts with others by using various sharing options.

- 1 Open the **Contacts** app and tap the More options icon (⋮) → **Select**.
- 2 Select contacts and tap **Share**.
- 3 Select contact information to share and tap **Done**.
- 4 Select a sharing method.

Creating groups

You can add groups, such as family or friends, and manage contacts by group.

- 1 Open the **Contacts** app and tap **Groups** → the Create icon (+).
- 2 Follow the on-screen instructions to create a group.

Merging duplicate contacts

If your contacts list includes duplicate contacts, merge them into one to streamline your contacts list.

- 1 Open the **Contacts** app and tap the More options icon (⋮) → **Settings** → **Merge duplicate contacts**.
- 2 Tick contacts and tap **Merge**.

Setting up your profile

You can set your profile picture and profile card.

- 1 Open the **Contacts** app and tap your profile.
- 2 Tap **Create profile card**.
- 3 Follow the on-screen instructions to set up your profile card.
The image you select for the profile card will also be applied as your profile picture.
- 4 To change your profile picture, tap the profile picture or card and tap the Profile picture icon (📎).
- 5 Follow the on-screen instructions to set your profile picture.

Sharing your profile

People can view your profile when you call them or when they check your contact information.

- 1 Open the **Contacts** app and tap your profile.
- 2 Tap **Profile card and picture** and tap the **Share profile card and picture** switch to turn it on.



Messages

Introduction

Send and check messages by conversation.

You may incur additional charges for sending or receiving messages when you are roaming.

Sending messages

- 1 Open the **Messages** app and tap the Compose new message icon ().
- 2 Add recipients and enter a message.
To record and send a voice message, touch and hold the Voice message icon () and say your message. The recording icon appears only while the message input field is empty.
- 3 Tap the Send icon () to send the message.

Checking messages

- 1 Open the **Messages** app and tap **Conversations**.
- 2 On the messages list, select a contact or a phone number.
 - To reply to the message, tap the message input field, enter a message, and then tap the Send icon ().
 - To adjust the font size, spread two fingers apart or pinch on the screen.

Sorting messages

You can sort messages by category.

Open the **Messages** app and tap **Conversations** → the Add category icon (+).

If the category option does not appear, tap the More options icon (⋮) → **Settings** and tap the **Conversation categories** switch to turn it on.

Deleting messages

Touch and hold a message to delete, then tap **Delete**.

Changing message settings

Open the **Messages** app and tap the More options icon (⋮) → **Settings**. You can block unwanted messages, change notification settings, and more.

Camera

Introduction

Take pictures and record videos using various modes and settings.

Camera etiquette

- Do not take pictures or record videos of other people without their permission.
- Do not take pictures or record videos where legally prohibited.
- Do not take pictures or record videos in places where you may violate other people's privacy.

Taking pictures

1 Open the **Camera** app.

You can also open the app by pressing the Side button twice or dragging the Camera icon () to the left on the locked screen.

-  • Some camera features are not available when you open the **Camera** app from the locked screen or when the screen is turned off while the screen lock method is set.
- The camera automatically shuts off when unused.
- Some methods may not be available depending on the carrier or model.

2 Tap the image on the preview screen where the camera should focus.

To adjust the brightness of pictures, drag the adjustment bar that appears above or below the circular frame.

3 Tap the Take picture icon (○) to take a picture.

To change the shooting mode, drag the shooting modes list to the left or right, or swipe to the left or right on the preview screen.

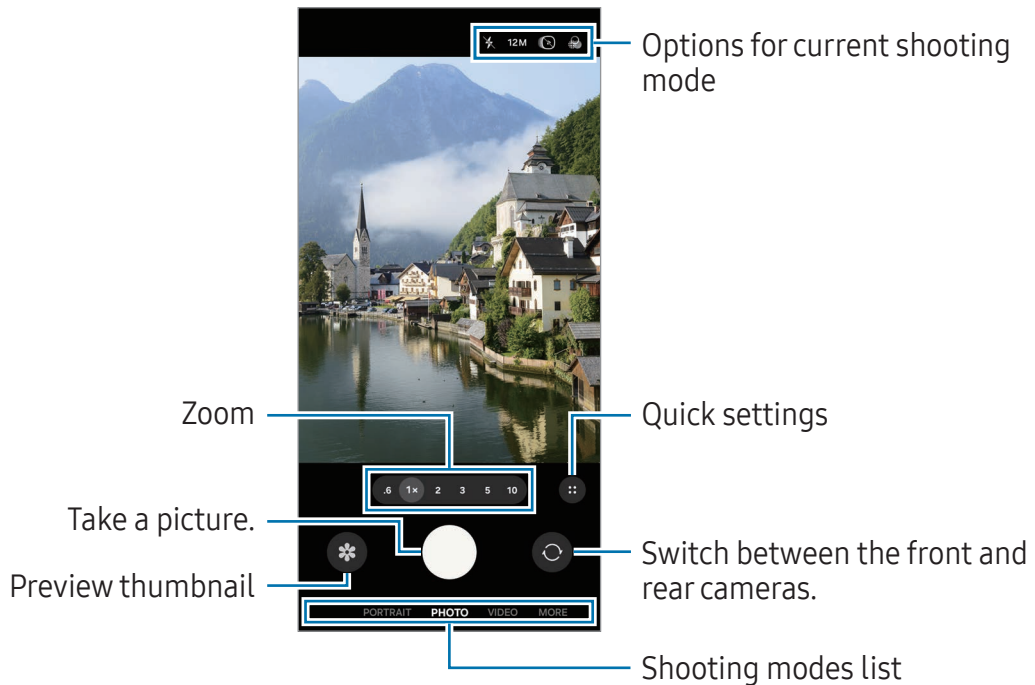

- The preview screen may vary depending on the shooting mode and which camera is being used.
- The focus may not be clear if the subject is close. Take pictures or videos from a good distance.
- If pictures you take appear blurry, clean the camera lens and try again.
- Make sure that the lens is not damaged or contaminated. Otherwise, the device may not work properly in some modes that require high resolutions.
- Your device’s camera features a wide-angle lens. Minor distortion may occur in wide-angle pictures or videos and does not indicate device performance problems.
- The camera may fog up or form condensation if the device is exposed to sudden changes in air temperature, because of the difference in temperature outside and inside the camera cover. Try to avoid such conditions when planning to use the camera. If fogging does occur, allow the camera to dry naturally at room temperature before taking pictures or recording videos, otherwise results may look blurry.

Using the camera button

- Touch and hold the camera button to record a video.
- If you drag the camera button to the Lock icon (🔒), you can record a video without holding the button.
- To take burst shots, swipe the camera button to the edge of the screen and hold it. If you tap the Quick controls icon (⋮) → the Settings icon (⚙️) on the preview screen and tap **Swipe Shutter button to** → **Create GIF**, you can create GIFs.
- If you add another camera button, you can move it anywhere on the screen and take pictures more conveniently. On the preview screen, tap the Quick controls icon (⋮) → the Settings icon (⚙️) → **Shooting methods** and tap the **Floating Shutter button** switch to turn it on.

Editing the shooting modes list

To edit the shooting modes list, tap **MORE** on the list, tap **Edit**, and then drag modes to where you want.

Using zoom features

To zoom in or out while using the rear camera, select the desired zoom icon on the preview screen.

You can also select the desired zoom level from the zoom level list that appears when you tap the zoom icon.

To adjust the zoom more precisely, drag the zoom icon, pinch, or spread two fingers apart on the preview screen.

If the zoom ratio exceeds a certain amount, a zoom guide map will appear to indicate where you are zooming in on the image.

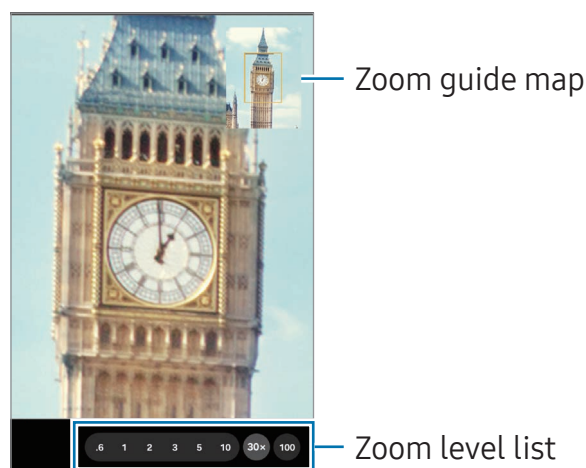

Locking the focus (AF) and exposure (AE)













You can lock the focus or exposure on a selected area to prevent the camera from automatically adjusting based on changes to the subjects or light sources.



Touch and hold the area to focus, the AF/AE frame will appear on the area and the focus and exposure setting will be locked. The setting remains locked even after you take a picture.

 This feature may not be available depending on the shooting mode.

Options for current shooting mode

On the preview screen, use the following options. To use more options, tap the Quick controls icon ()

-  : Turn the flash on or off.
- **12M**: Select a resolution for pictures.
-  : Turn the motion photo feature on or off. If you turn it on, a video clip will also be taken from a few seconds before or both before and after tapping the camera button.
-  : Apply a filter effect.
-  : Turn the super steady feature on or off.
-  : Select a frame rate for hyperlapse videos.
- **FHD** / **FHD** / **FHD**: Select a resolution for videos.
-  : Select a metering method. This determines how light values are calculated. **Centre-weighted metering** () uses the light in the centre portion of the shot to calculate the exposure of the shot. **Matrix metering** () averages the entire scene. **Spot metering** () uses the light in a concentrated centre area of the shot to calculate the exposure of the shot.
-  : In **PRO VIDEO** mode, select which direction's sound you want to record at a higher level. You can also use a USB or Bluetooth microphone by connecting it to your device.
-  : In **PRO** or **PRO VIDEO** mode, change the option for the exposure monitor. Select an option to display overexposed or underexposed levels with a pattern or colour on the preview screen.
-  : Turn the log video feature on or off. If you turn it on, you can record videos with a wider dynamic range for more flexibility when editing.

- : In **FOOD** mode, focus on a subject inside the frame and blur the image outside the frame.
- : In **DUAL REC** mode, change the saving option.

 The available options may vary depending on the model or shooting mode.

Photo mode

The camera adjusts the shooting options automatically depending on the surroundings. On the shooting modes list, tap **PHOTO** and tap the Take picture icon () to take a picture.

Changing the resolution



You can take high-resolution pictures.

In shooting options, tap **12M** to change the resolution to the one you want, and take a picture.

 The resolution may vary depending on the model.

Shot suggestions

The camera suggests the ideal composition for the picture by recognising the position and angle of your subject.

On the preview screen, tap the Quick controls icon () → the Settings icon () and tap the **Shot suggestions** switch to turn it on.

- 1 On the shooting modes list, tap **PHOTO**.
A guide will appear on the preview screen.
- 2 Point the guide at the subject.
The camera recognises the composition, and the recommended composition appears on the preview screen.
- 3 Move the device so the guide matches the recommended composition.
When the ideal composition is achieved, the guide will change to yellow.

- 4 Tap the Take picture icon (○) to take a picture.

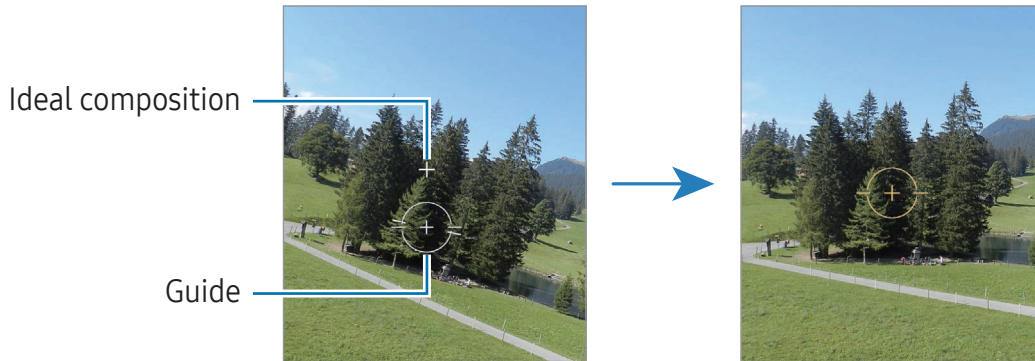

Taking selfies

You can take self-portraits with the front camera.

- 1 On the preview screen, swipe upwards or downwards, or tap the Switch to the front camera icon (📷) to switch to the front camera for self-portraits.
- 2 Face the front camera lens.
To take self-portraits with a wide-angle shot of the landscape or people, tap the Switch to wide icon (📷).
- 3 Tap the Take picture icon (○) to take a picture.



Taking clear close-up pictures (Galaxy S24 Ultra)

Take clear close-up pictures of your subject.

- 1 On the preview screen, tap **1x**.
 - 2 Put the camera near to the subject.
 - 3 When the Focus enhancer on icon (🌻) appears, tap the Take picture icon (○) to take a picture.
- 📝 If this feature is not turned on, tap the Focus enhancer off icon (🌻) to turn it on.





Scanning documents or text

You can scan documents or text.

- 1 On the shooting modes list, tap **PHOTO**.
- 2 Point the camera towards the object and tap the Scan documents and text icon (). The Scan documents and text icon () will only appear when a document or text is detected.
- 3 Tap **Scan**, select the area you want, and then tap **Save**.

Video mode

The camera adjusts the shooting options automatically depending on the surroundings.

- 1 On the shooting modes list, tap **VIDEO** and tap the Start recording icon () to record a video.
 - To switch between the front and rear cameras while recording, swipe upwards or downwards on the preview screen or tap the Switch to the front camera icon ().
 - To capture an image from the video while recording, tap the Capture icon ().
 - To record the sound from a specific direction at a higher volume while recording a video, point the camera towards that direction and adjust the zoom.
- 2 Tap the Stop recording icon () to stop recording the video.
 -  • If you use the video zoom feature for a long time while recording a video, the video quality may diminish to prevent your device from overheating.
 - The optical zoom may not work in low-light environments.

Changing the resolution

You can record high-resolution videos with a maximum resolution of 8K.

In shooting options, tap the FHD 30 fps icon () to change the resolution to the one you want, and record a video.

When you finish recording a video, play it in the **Gallery** app. When you tap the Capture icon () on a frame that you like, the frame will be saved as a picture.

Stabilising videos (Super steady)

If there is a lot of shaking when recording videos, use the Super steady feature for further video stabilisation.

Tap **VIDEO** on the shooting modes list, tap the Super steady icon () on the shooting options to turn it on, and then record a video.

Using the auto framing feature

(Changing the shooting angle and zoom by tracking people)







You can set the device to change the shooting angle and zoom automatically by recognising and tracking people while recording videos.

On the shooting modes list, tap **VIDEO**, tap the Quick controls icon () → the Auto framing icon () to turn it on, and then record a video.

To track and adjust the shooting angle and zoom in on a selected person, tap the frame that is displayed around the person. To turn off tracking, tap the frame again.

Dual rec mode

Record videos with two cameras at the same time. You can save the videos of each camera separately and edit them. You can also play the videos in various ways, such as in split view or picture-in-picture view.

- 1 On the shooting modes list, tap **MORE** → **DUAL REC**.
- 2 Tap the Select lenses icon () , select two lenses, and then tap **OK**.
 - To save the videos of each camera separately, tap the Save video as previewed icon () .
 - To change the screen, tap the Quick controls icon () → the View mode icon () .
- 3 Tap the Start recording icon () to record a video.
- 4 Tap the Stop recording icon () to stop recording the video.

Controlling the picture-in-picture window while playing the video

If you set the screen to **Picture-in-picture view** (📺), you can change the size or location of the picture-in-picture window while recording or playing the video.

- 1 On the preview screen, tap the Save video as previewed icon (📺) to change the saving option to **Save videos in separate files** (📁).
- 2 Tap the Start recording icon (📹) to record a video.
You can change the size or location of the picture-in-picture window before and during recording.
 - To enlarge the picture-in-picture window, tap the window and tap the Enlarge picture-in-picture icon (📺).
 - To move the picture-in-picture window, drag it to wherever you want.
- 3 Tap the Stop recording icon (⏹) to stop recording the video.

You can also control the picture-in-picture window while playing the video. Tap the preview thumbnail on the preview screen, or open the **Gallery** app and select the video, and then tap the More options icon (⋮) → **Open in Video player**.

Single take mode

Take various pictures and videos in one shot.

Your device automatically selects the best shot and creates pictures with filters or videos with certain sections repeated.

- 1 On the shooting modes list, tap **MORE** → **SINGLE TAKE**.
- 2 Tap the Start recording icon (📹) to capture the scene you want.
- 3 Tap the preview thumbnail on the preview screen or open the **Gallery** app and select the file.
To check other results, tap the Single take icon (📷). To save the results individually, touch and hold an item, tick the items you want, and then tap the Save icon (📁).

Portrait mode / Portrait video mode

By using Portrait mode or Portrait video mode, you can capture pictures or videos where the background is blurred and the subject stands out clearly. You can also apply a background effect and edit it after taking a picture.

- 1 On the shooting modes list, tap **PORTRAIT** or tap **MORE** → **PORTRAIT VIDEO**.
- 2 Tap the Portrait icon (👤) and select a background effect you want.
To adjust the intensity of the background effect, drag the adjustment bar.
- 3 When **Ready** appears on the preview screen, tap the Take picture icon (📷) to take a picture or tap the Start recording icon (📹) to record a video.

- 📌 • The available options may vary depending on the shooting mode.
- Use this feature in a place that has sufficient light.
- The background blur may not be applied properly in the following conditions:
 - The device or the subject is moving.
 - The subject is thin or transparent.
 - The subject has a similar colour to the background.
 - The subject or background is plain.

Pro mode / Pro video mode

Capture pictures or videos while manually adjusting various shooting options, such as exposure value and ISO value.

On the shooting modes list, tap **MORE** → **PRO** or **PRO VIDEO**. Select options and customise the settings, and then tap the Take picture icon (📷) to take a picture or tap the Start recording icon (📹) to record a video.

Available options

When you tap an option, the options list will appear. On the list, select options and customise the settings.

- 🔄 : Reset the settings.
- **ISO**: Select an ISO value. This controls camera light sensitivity. Low values are for stationary or brightly lit objects. Higher values are for fast-moving or poorly lit objects. However, higher ISO settings can result in noise in pictures or videos.

- **SPEED:** Adjust the shutter speed. A slow shutter speed allows more light in, so the picture or video becomes brighter. This is ideal for pictures or videos of scenery or pictures or videos taken at night. A fast shutter speed allows less light in. This is ideal for capturing pictures or videos of fast-moving subjects.
- **EV:** Change the exposure value. This determines how much light the camera's sensor receives. For low-light situations, use a higher exposure.
- **FOCUS:** Change the focus mode. Drag the adjustment bar to manually adjust the focus.
- **WB:** Select an appropriate white balance, so images have a true-to-life colour range. You can set the colour temperature.

Changing the resolution

You can record high-resolution videos with a maximum resolution of 8K.

In shooting options, tap the FHD 30 fps icon ($\frac{\text{FHD}}{30}$) to change the resolution to the one you want, and record a video.

When you finish recording a video, play it in the **Gallery** app. When you tap the Capture icon () on a frame that you like, the frame will be saved as a picture.

Separating the focus area and the exposure area

You can separate the focus area and the exposure area.

Touch and hold the preview screen. The AF/AE frame will appear on the screen. Drag the frame to the area where you want to separate the focus area and the exposure area.

Night mode

Take a picture in low-light conditions, without using the flash. When you use a tripod, you can get brighter and steadier results.

- 1 On the shooting modes list, tap **MORE** → **NIGHT**.
If you set the time that appears at the left bottom of the screen to **Max**, you may get clearer pictures.
- 2 Tap the Take picture icon () and hold your device steady until shooting is complete.

Food mode

Take pictures of food with more vibrant colours.

- 1 On the shooting modes list, tap **MORE** → **FOOD**.
A frame will appear on the screen and the area outside the frame will be blurred.
- 2 To resize the frame, drag a corner of the frame.
Tap the area you want or drag the frame to move it.
- 3 Tap the Quick controls icon (⋮) → the Colour temperature icon (🌡️) and drag the adjustment bar to adjust the colour temperature.
- 4 Tap the Take picture icon (📷) to take a picture.

Panorama mode

Using panorama mode, take a series of pictures and then stitch them together to create a wide scene.

- 1 On the shooting modes list, tap **MORE** → **PANORAMA**.
 - 2 Tap the Take picture icon (📷) and move the device slowly in one direction.
Keep the image within the frame on the camera's viewfinder. If the preview image is out of the guide frame or you do not move the device, the device will automatically stop taking pictures.
 - 3 Tap the Done icon (■) to stop taking pictures.
-  Avoid taking pictures of indistinct backgrounds, such as an empty sky or a plain wall.

Slow motion mode

Record a video for viewing it in slow motion. You can specify sections of your videos to be played in slow motion.

- 1 On the shooting modes list, tap **MORE** → **SLOW MOTION** and tap the Start recording icon (📹) to record a video.
- 2 When you are finished recording, tap the Stop recording icon (⏹) to stop.
- 3 On the preview screen, tap the preview thumbnail.
The fast section of the video will be set as a slow motion section and the video will start playing. Up to two slow motion sections will be created based on the video.
To edit the slow motion section, tap the Edit icon (✎) and drag the section editing bar to the left or right.

Change the playback speed.

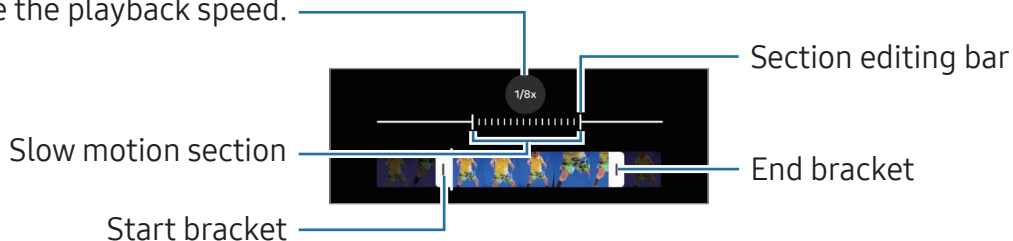

Hyperlapse mode

Record scenes, such as passing people or cars, and view them as fast-motion videos.

- 1 On the shooting modes list, tap **MORE** → **HYPERLAPSE**.
 - 2 Tap the Speed icon (📹) and select a frame rate option.
 - If you set the frame rate to **AUTO**, the device will automatically adjust the frame rate according to the changing rate of the scene.
 - If you want to record star trails, set the frame rate to the Night three hundred times faster icon (+300x) and tap the Star trails icon (🌠).
 - 3 Tap the Start recording icon (📹) to start recording.
 - 4 Tap the Stop recording icon (⏹) to finish recording.
- 📌 You can use the night hyperlapse feature by tapping the Speed icon (📹) → the Night fifteen times faster icon (🌃15x) or the Night forty five times faster icon (🌃45x) on the shooting options. This feature is good for doing things like taking shots from moving cars that make the light look like it is also moving.

Customising camera settings

On the preview screen, tap the Quick controls icon (⋮) → the Settings icon (⚙️). Some options may not be available depending on the shooting mode.

Intelligent features

- **Scan documents and text:** When a document or text is detected by the rear camera, the Scan documents and text icon (📄) will appear.
- **Scan QR codes:** Set the device to scan QR codes from the preview screen.
- **Shot suggestions:** Set the device to suggest the ideal composition for the picture by recognising the position and angle of your subject.
- **Intelligent optimisation**
 - **Quality optimisation:** Select a quality option.
 - **Scene optimiser:** Set the device to adjust the colour settings and apply the optimised effect automatically depending on the subject or scene.

Pictures

- **Swipe Shutter button to:** Select an action to perform when you swipe the camera button to the edge of the screen and hold it.
- **Watermark:** Add a watermark when taking pictures.
- **Advanced picture options:** Select how you want to save picture.
 - **High efficiency pictures:** Take pictures in the High Efficiency Image Format (HEIF).
 - **Pro mode picture format:** Select the file format for saving pictures taken in pro mode. JPEG files compress pictures and take up less storage. RAW files (DNG file format) retain all of a picture's data for the best image quality and save pictures as uncompressed, but they take up more storage. When you select **RAW and JPEG formats**, each picture is saved in two formats, DNG and JPG.
 - **Motion photo capture:** Set to take a video clip from a few seconds before or both before and after tapping the camera button.

Selfies

- **Save selfies as previewed:** Set the device to save pictures or videos as they appear on the preview screen when taken with the front camera without flipping them.
- **Swipe up/down to switch cameras:** Turn on this feature to switch cameras by swiping upwards or downwards on the preview screen.

Videos

- **Auto FPS:** Set the device to record brighter videos in low-light conditions by automatically optimising the frame rate.
 - **Video stabilisation:** Turn on anti-shake to reduce or eliminate blurry image resulting from camera shake while recording a video.
 - **Advanced video options**
 - **Video format:** Select the video format.
 - **High bitrate videos:** Increase the bitrate of videos. If you use this feature, the file size may be larger than normal videos.
 - **HDR10+ videos:** You can record videos in which each scene's contrast and colour are optimised.
 - **Log:** Add the log video option to the preview screen.
 - **Zoom-in mic:** While recording a video, you can record sound from the zoomed-in direction at a higher volume.
 - **360 audio recording:** You can record more immersive 3D sound videos using Bluetooth headphones that support the 360 audio recording feature.
 - **Audio playback:** You can play media without pause while recording videos. Media will pause when the 360 audio recording feature is on.
-  • You might not be able to play the HEVC videos on other devices or share them online.
- You cannot record videos in the HEVC format in some shooting modes.
 - To play the HDR10+ video properly, the device must support HDR10+.

General

- **Tracking auto focus:** Set the device to track and automatically focus on a selected subject. When you select a subject on the preview screen, the device will focus on the subject even if the subject is moving or you change the camera's position.
 - ✎ Tracking a subject may fail in the following conditions:
 - The subject is too big or too small.
 - The subject moves excessively.
 - The subject is backlit or you are shooting in a dark place.
 - Colours or patterns on the subject and the background are the same.
 - The subject includes horizontal patterns, such as blinds.
 - The camera shakes excessively.
 - The video resolution is high.
 - When zooming in or out using the optical zoom.
- **Composition guide:** Display viewfinder guides to help composition when selecting subjects.
- **Location tags:** Attach a GPS location tag to the picture.
 - ✎
 - GPS signal strength may decrease in locations where the signal is obstructed, such as between buildings or in low-lying areas, or in poor weather conditions.
 - Your location may appear on your pictures when you upload them to the internet. To avoid this, turn off the location tag setting.
- **Shooting methods**
 - **Press Volume buttons to:** Take pictures or record videos, zoom in or out, or control the volume using the Volume button.
 - **Voice commands:** Take pictures or record videos using voice commands.
 - **Floating Shutter button:** Add another movable button anywhere on the screen to take pictures.
 - **Show palm:** Show your palm to the front camera to take selfies or start recording videos.

- **Settings to keep:** Keep the last settings you used, such as the shooting mode, when you open the camera.
- **Vibration feedback:** Set the device to vibrate in certain situations, such as when you tap the camera button.

Privacy

- **Permissions:** Access the permissions required to use the Camera app.
- **Reset settings:** Reset the camera settings.
- **About Camera:** Check the Camera app version and legal information.
- **Contact us:** Ask questions or check out the frequently asked questions.



Some features may not be available depending on the model.

Gallery

Introduction

Access images and videos stored in your device. You can also manage images and videos by album or create stories.

Using Gallery

Open the **Gallery** app.

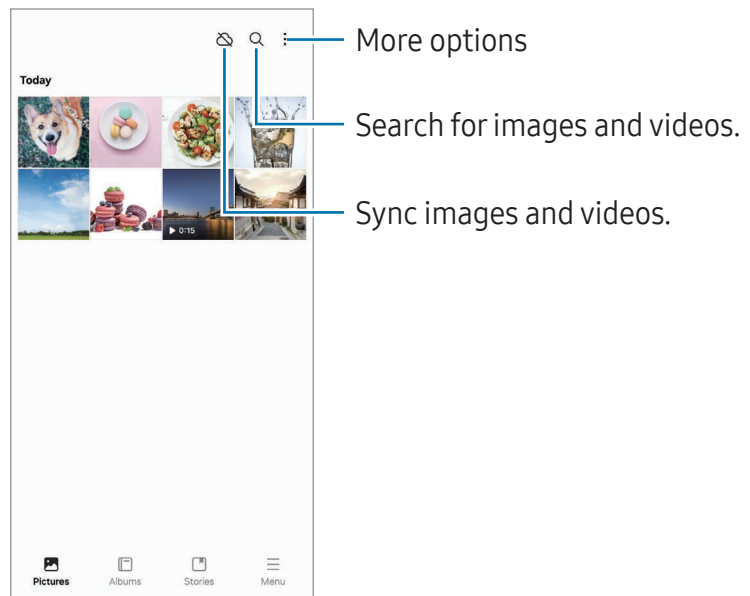

Viewing images

Open the **Gallery** app and select an image. To view other files, swipe to the left or right on the screen.

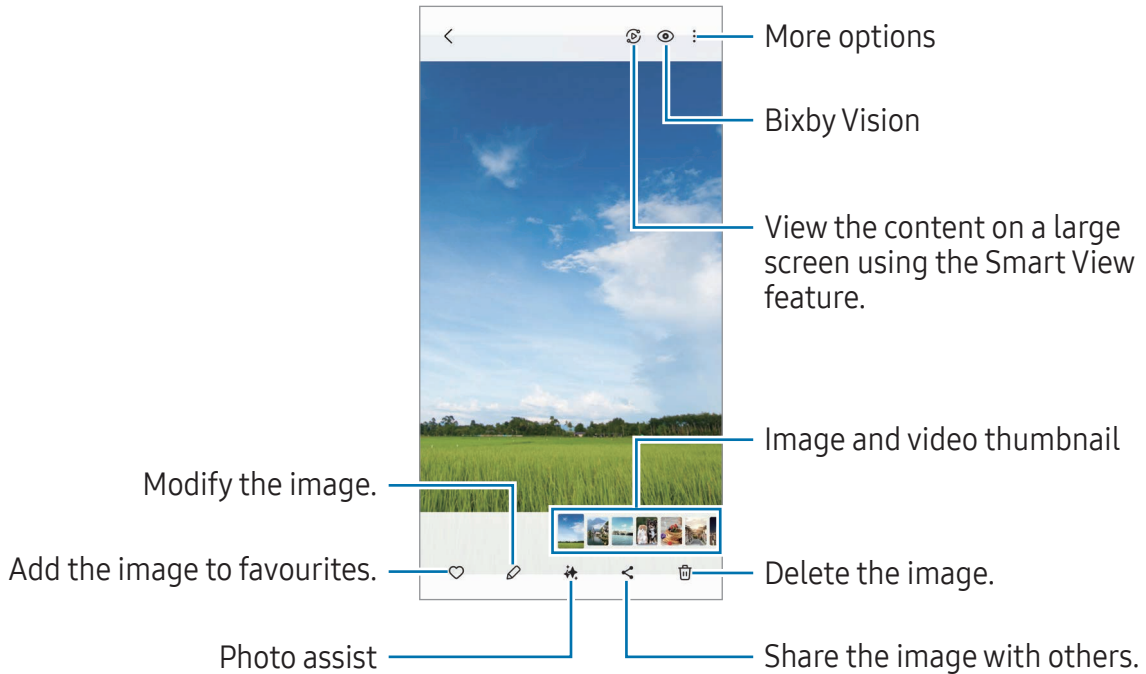

Remastering images

You can enhance the dull, blurry, and low-resolution images.

- 1 Open the **Gallery** app and select an image.
- 2 Swipe upwards on the screen and tap **Remaster**.
You can check the before and after.
- 3 Tap the Save icon (↓) to save the remastered image.

Extracting objects from images

Separate an object from the background and extract it. You can copy the extracted image or use it in various ways by saving it as a sticker or an image.

- 1 Open the **Gallery** app and select an image or a video.
- 2 Touch and hold on the object you want extract and select an option.
When you select an image taken with the motion photo feature, the **Save as GIF** feature will appear. If you want to save the extracted image as a GIF, tap **Save as GIF**.

 For videos, this feature is only available when they are paused.

Cropping enlarged images

- 1 Open the **Gallery** app and select an image.
- 2 Spread two fingers apart on the area you want to save and tap the Quick crop icon ().
The cropped area will be saved as a file.

Viewing videos

Open the **Gallery** app and select a video to play. To view other files, swipe to the left or right on the screen.

To use more options during playback, tap the More options icon (⋮) → **Open in Video player**.

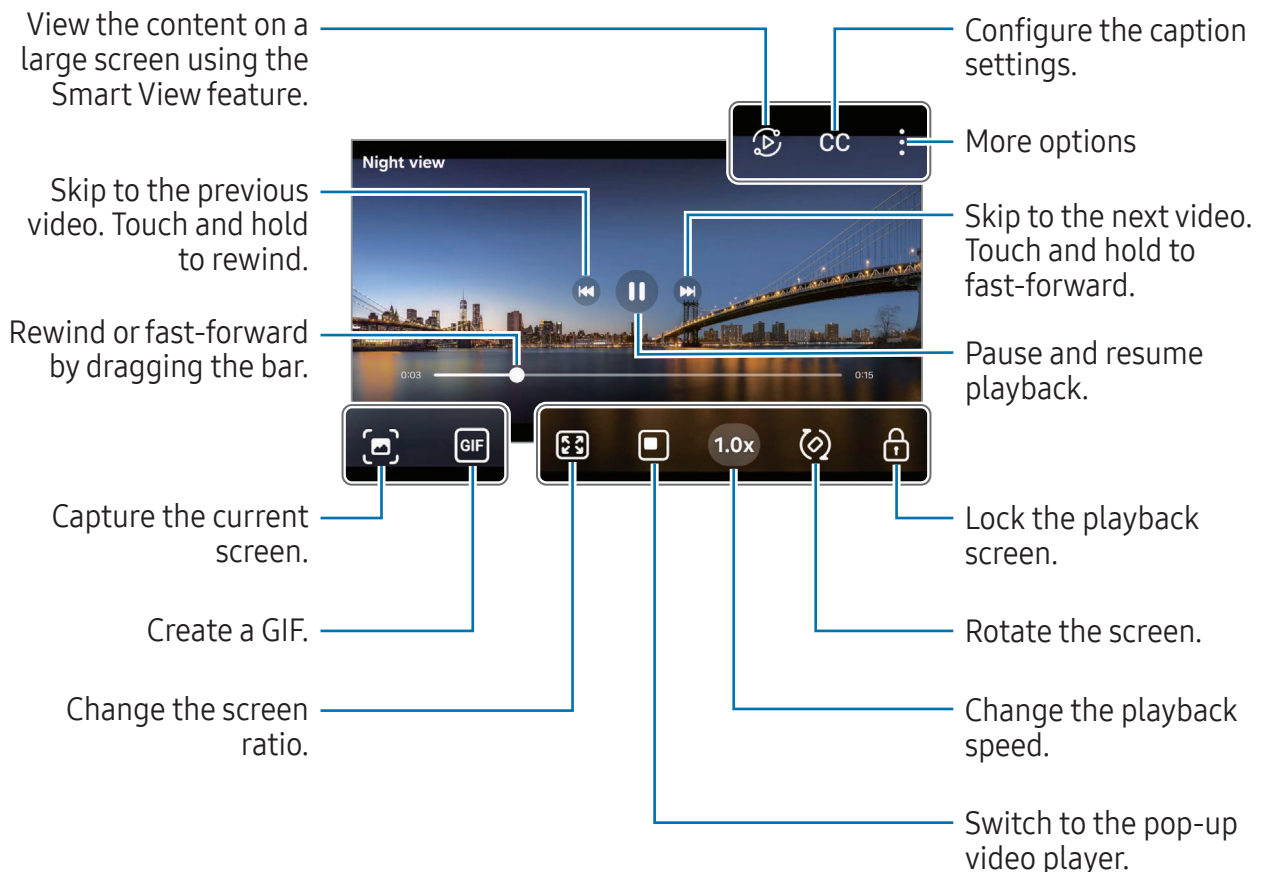

Drag up or down on the left side of the playback screen to adjust the brightness, or drag up or down on the right side of the playback screen to adjust the volume.

To rewind or fast-forward, swipe to the left or right on the playback screen.

Viewing brighter and clearer videos

Increase the screen brightness and make colours more vibrant when you play videos. Open **Settings** and tap **Advanced features** → **Video brightness** → **Bright**.

- This feature is only available in some apps.
- Using this feature will increase battery consumption.

Albums

Open the **Gallery** app, tap **Albums** → the Create icon (+), and then select an album type.

- **Album:** Create new albums and add images and videos manually.
- **Auto-updating album:** Create albums that automatically collect images of people you select.
- **Group:** Create a group of related albums.
- **Shared album:** Create albums that you can share with others.
- **Shared family album:** Create albums that you can share with your family.

 Some features may not be available depending on the region or the model.

Stories

When you capture or save images and videos, the device will read their date and location tags, sort the images and videos, and then create stories.

Open the **Gallery** app, tap **Stories**, and then select a story. If you tap the More options icon (⋮), you can use various options, such as changing the story title.

If you tap the More options icon (⋮) → **Create story** on the stories list, you can create stories manually.

Syncing images and videos

Open the **Gallery** app, tap the Sync with OneDrive icon (☁), and then follow the on-screen instructions to complete the sync. When the **Gallery** app and the cloud are synced, the icon will change to the Synced with OneDrive icon (☁).

While syncing, pictures and videos you take will also be saved in the cloud. You can access images and videos saved in the cloud in your **Gallery** app and from other devices.

 When you connect your Samsung account and Microsoft account, you can set the cloud storage as Microsoft OneDrive.

Deleting images or videos

Open the **Gallery** app, touch and hold an image, a video, or an album to delete, and then tap **Delete**.

Using the recycle bin feature

Images and videos you delete will be temporarily stored in the recycle bin. The files will be deleted after a certain period.

To access files in the recycle bin, open the **Gallery** app and tap **Menu** → **Recycle bin**. To restore files, tap **Select**, select files, and then tap **Restore**.

Bixby

Bixby is a user interface that helps you use your device more conveniently. You can say what you want to Bixby. Bixby will launch a feature you request or show the information you want.

Visit www.samsung.com/bixby for more information.

 Bixby is only available in some languages, and it may not be available depending on the region.

Waking up Bixby

While pressing and holding the Side button, say what you want to Bixby. To use this feature, open **Settings** and tap **Advanced features** → **Side button** → **Long press** → **Bixby**.

Alternatively, say the wake-up phrase, such as “Hi, Bixby” or “Bixby”, and then say what you want.

Setting a wake-up phrase

1 Open **Settings** and tap **Advanced features** → **Bixby** → **Voice registration**.

2 Select the wake-up phrase you want under **Voice wake-up**.

 When running this app for the first time or restarting it after performing a data reset, follow the on-screen instructions to complete the initial setup.

Bixby Vision

Bixby Vision is a service that provides various features based on image recognition. You can use Bixby Vision to search for information by recognising objects. Use a variety of useful Bixby Vision features.

-  • This feature may not be available or you might not get correct search results depending on the image size, format, or resolution.
- Samsung is not responsible for the product information provided by Bixby Vision.

Launching Bixby Vision

Launch Bixby Vision using one of these methods.

- In the **Camera** app, tap **MORE** on the shooting modes list and tap the Bixby Vision icon (👁️).
- In the **Gallery** app, select an image and tap the Bixby Vision icon (👁️).
- If you added the Bixby Vision app icon to the Home screen, open the **Bixby Vision** app.

Using Bixby Vision

1 Launch Bixby Vision.

2 Select a feature you want to use.

- **TRANSLATE:** Recognise text from documents or images and translate it.
- **TEXT:** Recognise text from documents or images and extract it.
- **DISCOVER:** Search for images similar to the recognised object online and related information.
- **SCENE DESCRIBER:** Analyse the scene you captured and describe it by voice.
- **OBJECT IDENTIFIER:** Recognise objects and describe them by voice.
- **TEXT READER:** Recognise text and read them aloud.
- **COLOUR DETECTOR:** Detect the colour of the object and say it aloud.

-  • The available features and search results may vary depending on the region or carrier.
- If some features do not appear, launch Bixby Vision, tap the More options icon (⋮) → **Settings**, and then tap the switches next to the features you want to turn on.

Multi window

(Using multiple apps at once)

Run apps at the same time in split screen view or multiple apps in the pop-up view.

 Some apps may not support this feature.

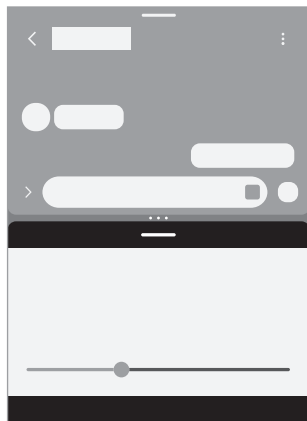

Split screen view

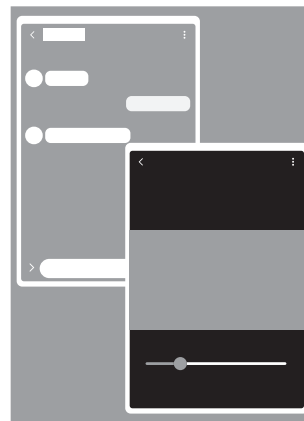

Pop-up view

Launching Multi window

- Recents button

Tap the Recents button (|||), tap an app's icon, and then tap **Open in split screen view** or **Open in pop-up view**.

- Swipe screen

Open **Settings**, tap **Advanced features** → **Multi window**, and then tap the **Swipe for split screen** or **Swipe for pop-up view** switch to turn it on.

-  • Drag the circles (• • •) between the app windows to adjust the size of the windows.
- Tap the circles (• • •) between the app windows and tap the Add app pair icon (☆). The apps you are using in the split screen view will be saved as an app pair.
- Drag the multi window handle (—) to a new location to move the app window.
- When you tap the multi window handle (—), the available menus will appear.

Samsung Internet

Browse the internet to search for information and bookmark your favourite webpages to access them conveniently.

- 1 Open the **Internet** app.
- 2 Enter the web address or a keyword, and then tap **Go**.

If the toolbar does not appear, swipe downwards slightly on the screen.

To switch between tabs, tap the Tabs icon (☰) or swipe to the left or right on the address field.

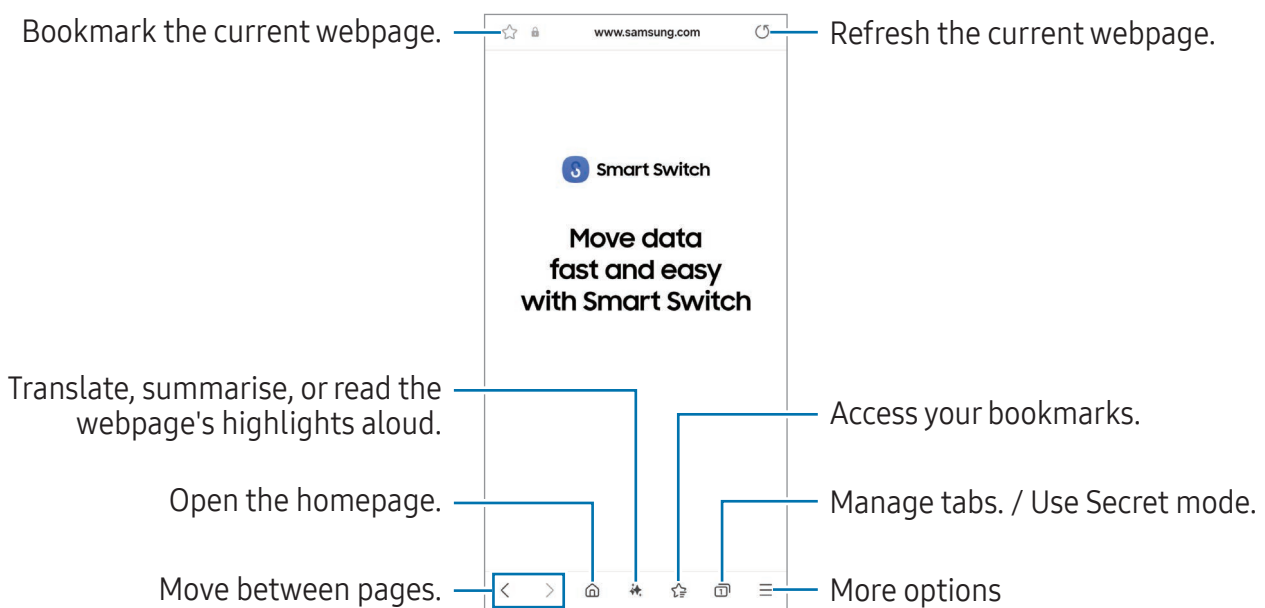

Using Secret mode

If you set a password for Secret mode, you can prevent others from accessing your search history, browsing history, bookmarks, and saved pages.

- 1 Tap the Tabs icon (☰) → **Turn on Secret mode**.
- 2 Tap the **Lock Secret mode** switch to turn it on, tap **Start**, and then set a password for Secret mode.

In Secret mode, the device will change the colour of the toolbars. To turn off Secret mode, tap the Tabs icon (☰) → **Turn off Secret mode**.

Samsung Wallet

Introduction

Use various convenient features in Samsung Wallet. You can make a payment, verify your identity through your biometric data, check tickets or boarding passes, and more.

You can check out more information, such as cards that support this feature at www.samsung.com/samsung-wallet.

Open the **Wallet** app and select a feature you want.



- This app may not be available depending on the region.
- Some features may not be available depending on the region.

Setting up Samsung Wallet

When running this app for the first time or restarting it after performing a data reset, follow the on-screen instructions to complete the initial setup.

- 1 Open the **Wallet** app.
- 2 Sign in to your Samsung account and read and agree to the terms and conditions.
- 3 Register your fingerprint and a PIN to use when making payments.
This PIN will be used to verify various actions in Samsung Wallet, such as making payments and unlocking the app.

Using Samsung Pay

Register cards to Samsung Pay to make both online and offline payments.



- To make payments with Samsung Pay, the device may be required a connection to a Wi-Fi or mobile network depending on the region.
- This feature may not be available depending on the carrier or model.
- The procedures for the initial setup and card registration may vary depending on the carrier or model.

Registering cards

Open the **Wallet** app and follow the on-screen instructions to complete your card registration.

Making payments

- 1 Drag a card image at the bottom of the screen upwards. Alternatively, open the **Wallet** app. Then, on the cards list, swipe to the left or right and select a card to use.
- 2 Scan your fingerprint or enter the payment PIN you set.
- 3 Touch the back of your device to the card reader.
When the card reader recognises the card information, the payment will be processed.

-  • Payments may not be processed depending on your network connection.
- The verification method for payments may vary depending on the card readers.

Cancelling payments

You can cancel payments by visiting the place where you made them.

On the cards list, swipe to the left or right to select the card you used. Follow the on-screen instructions to complete payment cancellation.

Verifying identity

Register your biometric data to Samsung Pass and verify your identity when using services which require your login or personal information. Refer to [Samsung Pass](#) for more information.

Using tickets

Add boarding passes and tickets for movies, sports, and more, to access and use them in one place.

Using a digital key

Register your vehicle's digital key to your phone so you can unlock or lock the vehicle's door and start the vehicle.

Start registering a digital key by installing your vehicle's digital key app or using the guide message, such as an email or text message, sent by your vehicle's manufacturer. Then, follow the on-screen instructions on your vehicle's navigation screen and your phone's Samsung Wallet screen to complete the registration.

-  • This feature may not be available depending on the region or model.
- To use this feature, the vehicle must support the digital key feature. Check with your vehicle's manufacturer for digital key support.
- The registered digital key is only saved to your phone and, if the phone is replaced, the digital key must be registered again.
- Some features may not be available depending on the vehicle. Check with your vehicle's manufacturer for more information.

Using a digital key with the NFC feature

Touch the NFC antenna area of the phone with the digital key registered to the vehicle's door. The door will unlock or lock.

After you place the phone on the vehicle's wireless charging pad and the digital key is authenticated, you can start the vehicle using the start button. If the digital key is not authenticated, try changing the position or orientation of the phone slightly.

-  • To use this feature, the phone and vehicle must support the NFC feature.
- To turn on the NFC feature on the phone, open **Settings**, tap **Connections** → **NFC and contactless payments**, and then tap the switch to turn it on.
- To find out the location of the wireless charging pad and which of your vehicle's doors support NFC, refer to your vehicle's user guide.

Using a digital key with the ultra-wideband (UWB) (Galaxy S24 Ultra, Galaxy S24+)

The vehicle's door will unlock when you get close to the vehicle with your phone, and will lock when you move away.

After the digital key is authenticated when you get inside the vehicle, you can start the vehicle using the start button.



- To use this feature, the phone and vehicle must support both the Bluetooth and UWB features. Open **Settings**, tap **Connections**, and then tap the **Bluetooth** switch and the **Ultra-wideband (UWB)** switch to turn them on.
- If the vehicle supports both the NFC and UWB features, you can choose the method you want. Refer to your vehicle's user guide for more information.
- The UWB feature may not be available depending on the region.
- The door unlock and lock methods may differ depending on the vehicle. Check with your vehicle's manufacturer for more information.
- Using this feature will increase battery consumption.

Deleting the digital key

You can delete the registered digital key from your phone.

Open the **Wallet** app, tap the registered digital key, and then tap the More options icon (⋮) → **Delete**.

Samsung Health

Samsung Health helps you manage your wellness and fitness. Set fitness goals, check your progress, and keep track of your overall wellness and fitness. You can also compare your step count records with other Samsung Health users and check out health tips.

Open the **Health** app. Visit www.samsung.com/samsung-health for more information.



Samsung Notes

Introduction



Create notes by entering text from the keyboard or by handwriting or drawing on the screen. You can also insert images or voice recordings into your notes.

 Some features may not be available depending on the model.

Creating notes

- 1 Open the **Notes** app, tap the Create icon () , and then create a note.
You can change the input method by tapping the Handwriting mode icon () or the Text mode icon () .



- 2 When you are finished composing the note, tap the Back button () to save it.
If you want to save the note in another file format, tap the More options icon () → **Save as file.**

Deleting notes

Touch and hold a note to delete and tap **Delete.**

Syncing notes

You can check and edit notes on all your devices signed in to the same Samsung account. Open the **Notes** app, tap the Navigation drawer icon (☰) → the Settings icon (⚙️), and then tap the **Sync with Samsung Cloud** switch to turn it on.

Composing notes with handwriting

On the note composer screen, tap the Handwriting mode icon (✍️) to draw or write in your own handwriting.

You can enter your handwriting in a larger size if you magnify the screen by spreading two fingers on it.

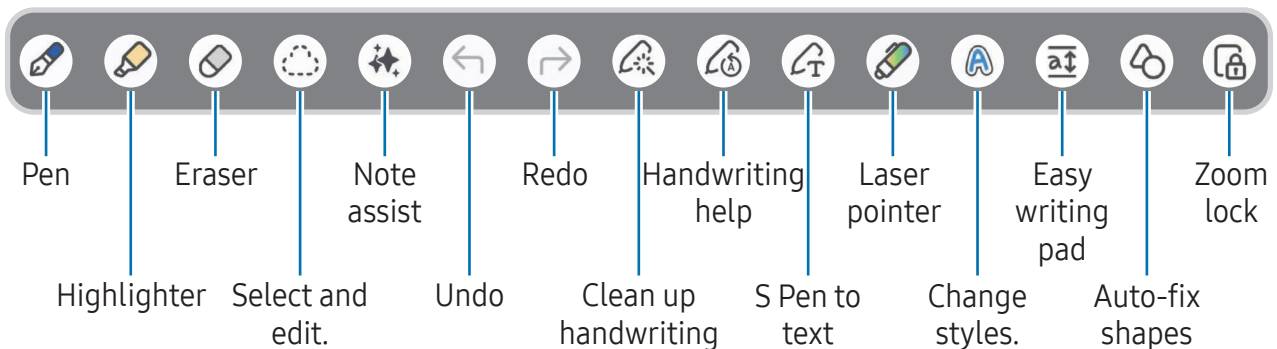

✎ If finger input does not work on a model that supports the S Pen, tap the More options icon (⋮) → **Turn on finger drawing**.

Using favourite pens

Register frequently used pens as favourites and change them by pressing the S Pen button.

To register favourite pens, tap the Pen mode icon (✍️) → the Favourite icon (🌟) → the Add icon (+), change the pen settings, such as the type or colour, and then tap **Done**.

On the note composer screen, press the S Pen button to change the pen. If you have registered multiple pens, press the S Pen button repeatedly to change to the desired pen.

- ✎ • Pressing the S Pen button close to the screen will launch the eraser, so press the S Pen button while holding it slightly away from the screen.
- If this feature is not turn on, open **Settings**, tap **Advanced features** → **S Pen**, and then tap the **Air actions** switch to turn it on.

Using the eraser

When you want to erase handwriting from a note, tap the Eraser mode icon () and select an area to erase. Alternatively, select an area while pressing and holding the S Pen button.



To change the eraser type, tap the Eraser mode icon () once more.

- **Stroke eraser:** Erase the line you select.
- **Area eraser:** Erase only the area you select. You can adjust the size of the eraser by dragging the size adjustment bar.

 Even with a smaller eraser, you may still not be able to precisely erase the intended part.

Editing handwritten notes

Edit handwritten notes using various editing options, such as cutting, moving, or resizing.

- 1 When there is handwriting on the note, tap the Selection mode icon ().
To change the shape of the selection, tap the Selection mode icon () once more.
- 2 Tap or draw a line around the input to select.
 - To move the input to another location, select the input, and then drag it to a new location.
 - To change the size of the selection, tap the input and drag a corner of the frame that appears.
- 3 Edit the input using the available options.

Aligning handwriting or converting to text



To straighten your handwriting or drawings horizontally, tap the Clean up handwriting icon () → **Align handwriting**.

To replace your handwriting with the converted text, tap the Clean up handwriting icon () → **Convert to text**. When the preview screen appears, tap the screen and tap **Add to**.

If you want to replace your handwriting with text right away, tap the S Pen to text icon () and then write on the screen with the S Pen.

Changing styles

You can change the style of your handwriting and drawings.

After writing or drawing on the screen, tap the Change style icon () twice and select a colour or line thickness you want. Then, point the S Pen toward where you want to apply the style. When the Arrow icon () appears, tap where you want to change the style.

Using the easy writing pad

On the note composer screen, tap the Easy writing pad icon (). The input field will be magnified and appear as the easy writing pad.



Automatically fixing shapes

Tap the Auto-fix shapes icon () and draw a shape. The shape will be fixed.

Recording voice to notes

Make a recording of your voice while creating a note, and then the content will be synchronised with the recording.

On the note composer screen, tap the Insert icon () → **Voice recording** and create a note.

Select a note from the list and tap the Open Voice Recorder icon () → the Play icon () to play the recording. Then the content you created while recording will be displayed on the screen along with the recording.

Adding memos to PDF files

Open the **Notes** app, tap the Import PDFs icon (), and then select a PDF file. You can add memos to the PDF file.

Pinning a note to the Home screen

Pin a note to the Home screen to check it or open and edit it.

- 1 Open the **Notes** app.
- 2 Select a note and tap the More options icon () → **Add to** → **Home screen** → **Add**.
The note will be added to the Home screen.

Clipping content

You can add content, such as a webpage link or an image, to a note.

- 1 When there is content you want to clip while using the **Samsung Internet**, **Messages**, or **Gallery** app, open the **Notes** app in the split screen view or in the pop-up view. For more information about the split screen view or the pop-up view, refer to [Multi window](#).

Alternatively, double tap the screen while pressing and holding the S Pen button, or open the Air command panel and tap **Create note**.

Options you can use will appear at the bottom of the note composer screen.

- 2 Select an option you want.

Samsung Members

Samsung Members offers support services to customers, such as device problem diagnosis, and lets users submit questions and error reports. You can also share information with others in the Galaxy users' community or check the latest news and tips. **Samsung Members** can help you solve any problems you might encounter while using your device.

Samsung Kids

You can restrict children's access to certain apps, set their usage times, and configure settings to provide a fun and safe environment for children when they use the device.

Open **Settings** and tap **Apps** → **Samsung Kids** → **Open**. When starting Samsung Kids for the first time or after performing a data reset, follow the on-screen instructions to complete the setup.

On the Samsung Kids screen, select the app you want to use.

 Your preset screen lock method or your created PIN will be used when turning on the **Parental controls** feature or closing Samsung Kids.

Using parental controls features

You can configure the settings for Samsung Kids and check the usage history.

On the Samsung Kids screen, tap the More options icon (⋮) → **Parental controls** and enter your unlock code.

Closing Samsung Kids

To close Samsung Kids, tap the Back button (◀) or tap the More options icon (⋮) → **Close Samsung Kids**, and then enter your unlock code.

Samsung Global Goals

The Global Goals, which were set up by the United Nations General Assembly in 2015, consist of goals that aim to create a sustainable society. These goals have the power to end poverty, fight inequality, and stop climate change.

With Samsung Global Goals, learn more about the global goals and join the movement for a better future.

Samsung TV Plus

Select the channels like you would use a TV and enjoy various video content free of charge.

Open the **TV** app.

 This app may not be available depending on the carrier or model.

Samsung Find

You can locate your device even if it is not connected to a network. You can also share your location with other people you preset.

Open the **Find** app.

Samsung Shop

Samsung Shop is the mobile shopping service provided by Samsung. Get offers or information about Samsung and its partners' products and services.

Open the **Samsung Shop** app.

 This app may not be available depending on the carrier or model.

Galaxy Shop

Access the Samsung website and check various information related to products.

Open the **Galaxy Shop** app.

 This app may not be available depending on the carrier or model.

Galaxy Wearable

Using the Galaxy Wearable app, you can manage your wearable devices. When you connect your phone to the wearable device, you can customise the wearable device's settings and apps.

Open the **Wearable** app.

Tap **More** → **Start** to connect your phone to the wearable device. Follow the on-screen instructions to finish the setup. Refer to the wearable device's user guide for more information about how to connect and use the wearable device with your device.

PENUP (Galaxy S24 Ultra)

PENUP is a social network service for sharing artwork drawn with the S Pen. Post your artwork, check out others' artwork, and get useful drawing tips.

Open the **PENUP** app.

Calendar

Manage your schedule by entering upcoming events in your planner.

Open the **Calendar** app and tap the Add event icon (+) or double tap a date. If the date already has saved events or tasks in it, tap the date and tap the Add event icon (+).

Syncing events with your accounts

- 1 Open **Settings**, tap **Accounts and backup** → **Manage accounts**, and then select the account to sync with.
- 2 Tap **Sync account** and tap the **Calendar** switch to turn it on.

To add accounts to sync with, open the **Calendar** app and tap the Navigation drawer icon (☰) → the Settings icon (⚙️) → **Manage calendars** → the More options icon (⋮) → **Add account**. Then, select an account to sync with and sign in.

Reminder

Register to-do items as reminders and receive notifications according to the condition you set.

Open the **Calendar** app and tap the Navigation drawer icon (☰) → **Reminders** (🔔) → the Add reminder icon (+). The Reminder screen will appear and the Reminder app icon (✔️) will be added to the Apps screen.

- To receive more accurate notifications, connect to a Wi-Fi or mobile network.
- To use location reminders, the GPS feature must be turned on. Location reminders may not be available depending on the model.





Using Reminder

Open the **Reminder** app.

- To create reminders, tap the Add reminder icon (+).
- To complete reminders, tap the Tick box icon (○) or select a reminder and tap **Complete**.
- To restore reminders, tap the Navigation drawer icon (☰) → **Completed**, select a reminder to restore, and then tap **Restore**.
- To delete a reminder, select a reminder and tap **Delete**.

Voice Recorder

Record or play voice recordings.

- 1 Open the **Voice Recorder** app.
- 2 Tap the Record icon () to start recording. Speak into the microphone.
 - Tap the Pause icon () to pause recording.
 - While making a voice recording, tap the Add bookmark icon () to insert a bookmark.
- 3 Tap the Stop icon () to finish recording.
- 4 Enter a file name and tap **Save**.



Changing the recording mode

Tap the Navigation drawer icon () → the Settings icon () → **Recording mode** and select a mode.

- **Standard:** This is the standard recording mode.
- **Interview:** The device records sound from the top and the bottom of the device at a high volume while reducing the volume of sound from the sides.

Playing selected voice recordings

When you review interview recordings, you can mute or unmute certain sound sources in the recording.

- 1 Select a voice recording made in interview mode.
- 2 To mute certain sound sources, tap the Mute icon () for the corresponding direction that sound is to be muted.
The icon will change to the Muted icon () and the sound will be muted.

My Files

(Checking and managing the files)

Access and manage various files stored in the device.

Open the **My Files** app.

To check for unnecessary data and free up the device's storage, tap **Manage storage**.

To search for files or folders, tap the Search icon (Q).

Clock





Set alarms, check the current time in many cities around the world, time an event, or set a specific duration.

Open the **Clock** app.

Calculator

Perform basic arithmetic or scientific calculations.



Open the **Calculator** app.

-  : Check the calculation history. To clear the history, tap **Clear history**. To close the calculation history panel, tap the Keypad icon ().
-  : Use the unit conversion tool. You can convert various values, such as area, length, or temperature, into other units.
-  : Display the scientific calculator.

Gaming Hub

Gaming Hub gathers your games downloaded from **Play Store** and **Galaxy Store** into one place.

Open the **Gaming Hub** app and select the game you want.

 Games downloaded from **Play Store** and **Galaxy Store** will be automatically shown on the Gaming Hub screen. If your games are not there, tap the Expand icon () → the More options icon () → **Add games**.

Removing a game from Gaming Hub





Tap the Expand icon (), touch and hold a game, and then tap **Remove from Gaming Hub**.

Game Booster

(Configuring your gaming environment)

You can play games in a better environment with Game Booster. You can use Game Booster while playing games.



To open the Game Booster panel while playing games, tap the Game Booster icon () at the bottom of the screen. If the icon is hidden, drag upwards from the bottom of the screen to show it.

- : Configure settings for each game, such as changing the performance mode.
- : Configure settings for Game Booster.
- **Touch protection**: Lock the screen while the game is being played. To unlock the screen, drag the lock icon in any direction.
- **Screenshot**: Capture screenshots.
- **Record**: Record your game sessions. To stop recording, tap the Stop icon ()
- **Block navigation buttons**: Hide the buttons on the navigation bar. To display the buttons, tap the Navigation button lock icon () on the navigation bar.
- **Block edge panel**: Hide the Edge panel handle while playing games.
- **Block auto brightness**: Disable automatic screen brightness adjustments while playing games.
- **Block Bixby**: Turn off Bixby while playing games.

- **Edit:** Edit the options list.
 - **Game optimisation:** Check the current performance mode.
 - **RAM:** Check the available memory.
-  • Available options may vary depending on the game.
- Game performance may be limited to control the device's temperature if the temperature rises above a certain level.

Changing the performance mode

You can change the game performance mode.

Tap the Game Booster icon () → the Settings icon () → **Game optimisation** and select the mode you want.

- **Performance:** This focuses on giving you high performance while playing games. If you use this mode, your device may heat up because of increased battery consumption.
- **Balanced:** This balances the performance and the battery usage time.
- **Battery saver:** This saves battery power while playing games.

 Battery power efficiency may vary by game.

Opening apps in pop-up windows while playing games

You can open apps in pop-up windows while playing a game.

Tap the Game Booster icon () → **Pop-up apps** and select an app from the apps list.

SmartThings

Control and manage smart appliances and Internet of Things (IoT) products.

Open the **SmartThings** app. For more information, tap **Menu** → **How to use**.

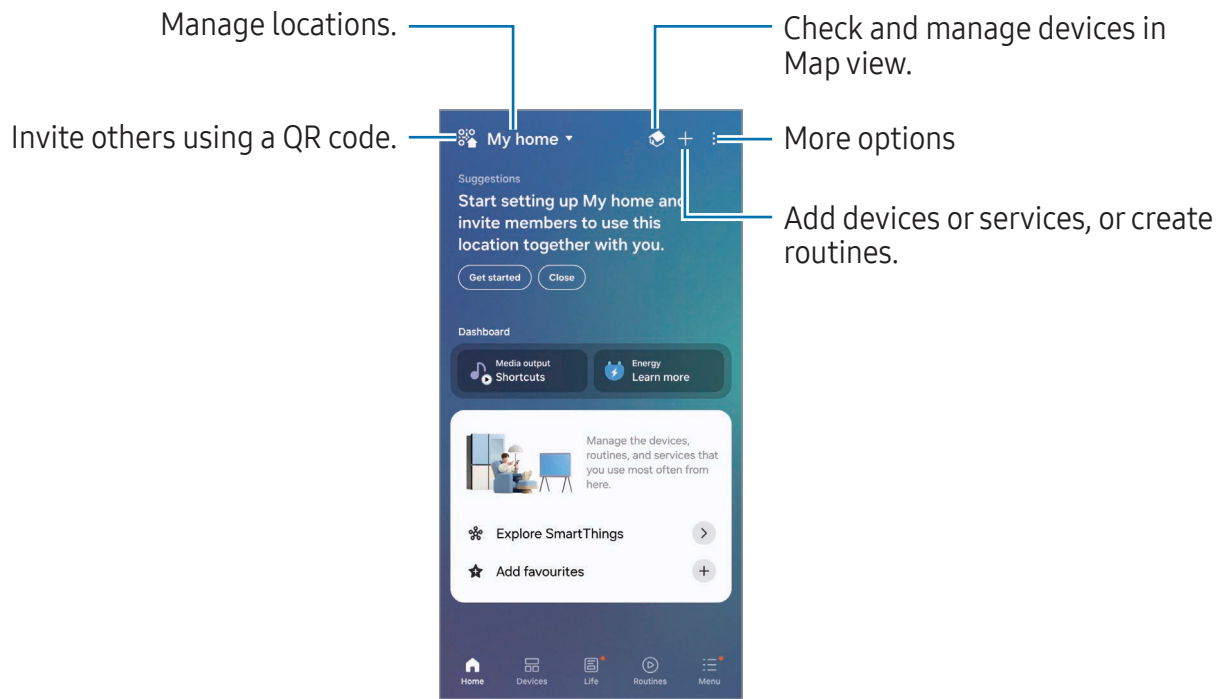

- **Home:** Add and manage frequently used devices, routines, or services.
- **Devices:** Add or manage devices.
- **Life:** Use various services, such as checking the device status or energy usage, and saving energy by using AI energy mode.
- **Routines:** Add or manage routines.
- **Menu:** Check useful information, supported devices, how to use certain features, and more.



- The devices you can connect may vary depending on the region. Available features may differ depending on the connected device.
- Connected devices' own problems or defects are not covered by the Samsung warranty. When problems or defects occur on the connected devices, contact the device's manufacturer.

Sharing content

Share content by using various sharing options. The following actions are an example of sharing images.

- 1 Open the **Gallery** app and select an image.
 - 2 Tap the Share icon (↗) and select a sharing method you want.
-  You may incur additional charges when sharing files through the mobile network.

Quick Share

Share content with nearby devices or people in your contacts.

- 1 Open the **Gallery** app and select an image.
- 2 On the other device, open **Settings** and tap **Connected devices** → **Quick Share** → **Who can share with you** → **Contacts only** or **Everyone** → **Done**.
- 3 Tap the Share icon (↗) → **Quick Share** and select a device to transfer the image to.
 - To share the link with a QR code, tap **QR code or link** and scan the QR code.
 - To share with contacts, tap **View contact**.
 - To share encrypted content, tap the More options icon (⋮) → **Turn on Private sharing**. Shared content cannot be saved, copied, or resent by the recipient.
- 4 Accept the file transfer request on the other device.

Setting who can find your phone

Set who is allowed to find and send content to your phone.

- 1 Open **Settings** and tap **Connected devices** → **Quick Share** → **Who can share with you**.
- 2 Select an option.
 - **No one**: Do not allow others to find your phone. Only other devices signed in to the same Samsung account can find your phone.
 - **Contacts only**: Share with people saved in your contacts.
 - **Everyone**: Allow any nearby devices to share with your phone.

Music Share

Using the Music Share feature, you can share your Bluetooth speaker that is already connected to your phone with another person. You can also listen to the same music on your Galaxy Buds and another person's Galaxy Buds.

This feature is available only on devices that support the Music Share feature.

Sharing a Bluetooth speaker

On your phone, open **Settings**, tap **Connected devices** → **Music Share**, and then tap the switch to turn it on.

Follow the on-screen instructions to share your Bluetooth speaker.

Listening to music together with Galaxy Buds

You can listen to music on your phone together through your Buds and your friend's Buds.

This feature is supported only on the Galaxy Buds series.

- 1 Make sure that each phone and pair of Buds are connected.
Refer to [Pairing with other Bluetooth devices](#) for how to connect.
- 2 On your friend's phone, open **Settings**, tap **Connected devices**, and then tap the **Music Share** switch to turn it on.
You can use additional features, such as setting who to share your device with, by tapping **Music Share**.
- 3 On your phone, open the quick settings panel and tap **Media output**.
- 4 Select your friend's Buds from the detected devices list.
- 5 On your friend's phone, accept the connection request.
When you play music through your phone, you can listen to it together through both Buds.

Smart View

(Mirroring on a TV screen)

View your phone's displayed content on a large screen by connecting your phone to a screen mirroring-enabled TV or monitor.



1 Open the quick settings panel and tap **Smart View**.

2 Select a device to mirror your phone's screen.

 When you play a video with Smart View, the resolution may vary depending on the TV model.

Casting apps to the screen

Only display the video on the connected screen while you are checking private messages or using other features on your phone at the same time.

Open the app to cast a video on the connected screen and tap the Smart View icon () → the App cast icon (.

 Some apps may not support this feature.

Samsung DeX

Using Samsung DeX, you can use your mobile device like a computer by connecting the mobile device to an external display, such as a TV or monitor. While using Samsung DeX, you can simultaneously use your mobile device.

Visit www.samsung.com/samsung-dex for more information.

- When starting or ending Samsung DeX, running apps may be closed.
- Some apps or features may not be available when using Samsung DeX.

Wireless connections to external displays

On your mobile device, open **Settings** and tap **Connected devices** → **Samsung DeX** → **Start DeX**. Follow the on-screen instructions to complete the connection. Some TVs or monitors will only be detected when its screen mirroring mode is turned on.

Wired connections to external displays

You can connect your mobile device to an external display using an HDMI adapter (USB Type-C to HDMI).

- Use only official Samsung DeX supported accessories that are provided by Samsung. Performance problems and malfunctions caused by using accessories that are not officially supported are not covered by the warranty.

Controlling the Samsung DeX screen

Use the following methods to control the Samsung DeX screen on an external display.

- Controlling with an external keyboard and mouse

You can use a wireless keyboard/mouse.

- You can set the mouse pointer to flow from the external display to the mobile device's screen. Open **Settings**, select **Samsung DeX** → **Mouse and trackpad**, and then select the **Flow pointer to phone screen** switch to turn it on.

- Using your mobile device as a touchpad

On your mobile device, tap the Touchpad icon () on the navigation bar. If you have set the navigation bar to use **Swipe gestures**, open the notification panel and tap **Use your phone as a touchpad**.

- Using the screen keyboard

When you enter text to send messages, create notes, or perform other tasks, a screen keyboard will appear automatically on your mobile device's screen without connecting an external keyboard.

Google apps

Google provides entertainment, social network, and business apps. You may require a Google Account to access some apps.

To check out more app information, access each app's help menu.

- **Chrome:** Search for information and browse webpages.
- **Gmail:** Send or receive emails through the Google Mail service.
- **Maps:** Find your location on the map, search the world map, and access location information for various places around you.
- **YT Music:** Enjoy various music and videos provided by YouTube Music. You can also access the music collections stored on your device and play them.
- **Google TV:** Purchase or rent videos, such as movies and TV programmes, from **Play Store**.
- **Drive:** Store your content on the cloud, access it from anywhere, and share it with others.
- **YouTube:** Watch or create videos and share them with others.
- **Photos:** Search for, manage, and edit all your pictures and videos from various sources in one place.
- **Google:** Search for items on the internet or your device.
- **Meet:** Make video calls or create or join video meetings.
- **Messages:** Send and receive messages on your device or computer, and share various content, such as images and videos.
- **Gemini:** Chat with Gemini to use various features, such as searching for information, creating custom images, or writing content.



Some apps may not be available depending on the carrier or model.

Settings

Introduction

Customise device settings.

On the Apps screen, tap **Settings**. Alternatively, open the quick settings panel and tap the Settings icon (⚙️).

To search for settings by entering keywords, tap the Search icon (🔍). You can also search for settings by selecting a recommended feature or a topic.

This chapter is a common guide for settings and features provided by Samsung devices.

Depending on the model, some content may differ, or descriptions of options or features not available on your device may be included.



Sign in to your Galaxy

Sign in to your Samsung account and manage it.

On the Settings screen, tap **Sign in to your Galaxy**.

Connections

Options

Change settings for various connections, such as the Wi-Fi feature and Bluetooth.

On the Settings screen, tap **Connections**.

- **Wi-Fi:** Turn on the Wi-Fi feature to connect to a Wi-Fi network and access the internet or other network devices. Refer to [Wi-Fi](#) for more information.
- **Bluetooth:** Use Bluetooth to exchange data or media files with other Bluetooth-enabled devices. Refer to [Bluetooth](#) for more information.
- **NFC and contactless payments:** Read near field communication (NFC) tags that contain information about products. You can also use this feature to make payments and buy tickets for transportation or events after downloading the required apps. Refer to [NFC and contactless payments \(NFC-enabled models\)](#) for more information.
- **Ultra-wideband (UWB):** Turn on the UWB feature.
- **Flight mode:** Set the device to turn off all wireless functions on your device. You can use only non-network services.
 - ⚠ Follow the regulations provided by the airline and the instructions of aircraft personnel. In cases where it is allowed to use the device, always use it in Flight mode.
- **SIM manager:** Activate your SIM or USIM cards and customise the SIM card settings. Refer to [SIM manager \(dual SIM models\)](#) for more information.
- **Mobile networks:** Configure your mobile network settings.

- **Data usage:** Keep track of your data usage amount and customise the settings for the limitation. Set the device to automatically disable the mobile data connection when the amount of mobile data you have used reaches your specified limit.

You can turn on the data saver feature to prevent some apps running in the background from sending or receiving data. Refer to [Data saver](#) for more information.

You can also set apps to use only a Wi-Fi or mobile data, or both. Refer to [Allowed networks for apps](#) for more information.

- **Mobile Hotspot and Tethering:** Use the phone as a mobile hotspot to share the phone's mobile data connection with other devices. For more information about Mobile Hotspot, refer to [Mobile Hotspot](#).



You may incur additional charges when using this feature.

- **More connection settings:** Customise settings to control other features. Refer to [More connection settings](#) for more information.



Some features may not be available depending on the model.

Wi-Fi

Turn on the Wi-Fi feature to connect to a Wi-Fi network and access the internet or other network devices.

Connecting to a Wi-Fi network

- 1 On the Settings screen, tap **Connections** → **Wi-Fi** and tap the switch to turn it on.
- 2 Select a network from the Wi-Fi networks list.
Networks with a lock icon require a password.



- Once the device connects to a Wi-Fi network, the device will reconnect to that network each time it is available without requiring a password. To prevent the device from connecting to the network automatically, tap the Settings icon (⚙️) next to the network and tap the **Auto reconnect** switch to turn it off.
- If you cannot connect to a Wi-Fi network properly, restart your device's Wi-Fi feature or the wireless router.

Sharing Wi-Fi network passwords

If you make a request to a person who is connected to a secured Wi-Fi network to share its password, you can connect to the network without entering the password. This feature is available between the devices which have contacts each other and the screen of the other device must be turned on.

- 1 On the Settings screen, tap **Connections** → **Wi-Fi** and tap the switch to turn it on.
- 2 Select a network from the Wi-Fi networks list.
- 3 Tap **Request password**.
- 4 Accept the share request on the other device.
The Wi-Fi password is entered on your device and it is connected to the network.

Wi-Fi Direct

Wi-Fi Direct connects devices directly through a Wi-Fi network without requiring an access point.

- 1 On the Settings screen, tap **Connections** → **Wi-Fi** and tap the switch to turn it on.
- 2 Tap the More options icon (⋮) → **Wi-Fi Direct**.
The detected devices are listed.
If the device you want to connect to is not in the list, request that the device turns on its Wi-Fi Direct feature.
- 3 Select a device to connect to.
The devices will be connected when the other device accepts the Wi-Fi Direct connection request.
To end the device connection, select the device to disconnect from the list.

Bluetooth

Use Bluetooth to exchange data or media files with other Bluetooth-enabled devices.

Precautions for using Bluetooth

- Samsung is not responsible for the loss, interception, or misuse of data sent or received through Bluetooth.
- Always ensure that you share and receive data with devices that are trusted and properly secured. If there are obstacles between the devices, the operating distance may be reduced.
- Some devices, especially those that are not tested or approved by the Bluetooth SIG, may be incompatible with your device.
- Do not use the Bluetooth feature for illegal purposes (for example, pirating copies of files or illegally tapping communications for commercial purposes). Samsung is not responsible for the repercussion of illegal use of the Bluetooth feature.

Pairing with other Bluetooth devices

- 1 On the Settings screen, tap **Connections** → **Bluetooth** and tap the switch to turn it on.

The detected devices will be listed.

- 2 Select a device to pair with.

If the device you want to pair with is not on the list, set the device to enter Bluetooth pairing mode. Refer to the other device's user guides.

-  Your phone is visible to other devices while the Bluetooth settings screen is open.

- 3 Accept the Bluetooth connection request on your phone to confirm.

The devices will be connected when the other device accepts the Bluetooth connection request.

To unpair the devices, tap the Settings icon () next to the device name to unpair and tap **Unpair**.

Sending and receiving data

Many apps support data transfer through Bluetooth. You can share data, such as contacts or media files, with other Bluetooth devices. The following actions are an example of sending an image to another device.

- 1 Open the **Gallery** app and select an image.
- 2 Tap the Share icon (↪) → **Bluetooth** and select a device to transfer the image to. If the device you want to pair with is not in the list, request that the device turns on its visibility option.
- 3 Accept the Bluetooth connection request on the other device.

NFC and contactless payments (NFC-enabled models)

You can use your phone to read near field communications tags (NFC) that contain information about products. You can also use this feature to make payments and buy tickets for transportation or events after downloading the required apps.

- ⚠ The device contains a built-in NFC antenna. Handle the device carefully to avoid damaging the NFC antenna.

Reading information from NFC tags

Use the NFC feature to read product information from NFC tags.

- 1 On the Settings screen, tap **Connections** and tap the **NFC and contactless payments** switch to turn it on.
- 2 Place the NFC antenna area on the back of your device near an NFC tag. The information from the tag appears.

- 📝 Ensure that the device's screen is turned on and unlocked. Otherwise, the device will not read NFC tags or receive data.

Making payments with the NFC feature

Before you can use the NFC feature to make payments, you must register for the mobile payment service. To register or get more information about the service, contact your service provider.

- 1 On the Settings screen, tap **Connections** and tap the **NFC and contactless payments** switch to turn it on.

2 Touch the NFC antenna area on the back of your device to the NFC card reader.

To set the default payment app, on the Settings screen, tap **Connections** → **NFC and contactless payments** → **Default wallet app** and select an app.

-  • The payment services list may not include all available payment apps.
- If you update the payment app or install a new one, the payment services that you used before may not work properly. If that is the case, on the Settings screen, tap **Connections** → **NFC and contactless payments** → **Default wallet app** or **Non-payment NFC services**, and then select another app instead of the updated or newly installed app. Or, deselect the selected app.

Data saver

Reduce your data usage by preventing some apps running in the background from sending or receiving data.

On the Settings screen, tap **Connections** → **Data usage** → **Data saver** and tap the switch to turn it on.

When the data saver feature is turned on, the Data saver icon () will appear on the status bar.

-  To select apps to use data without restriction, tap **Apps that can always use data** and select apps.

Allowed networks for apps

Set apps to use only a Wi-Fi or mobile data, or both.



For example, you can set the device to use only mobile data for apps that you want to keep secure or streaming apps that can be disconnected. Even if you do not turn off the Wi-Fi feature, the apps will open using the mobile data.

On the Settings screen, tap **Connections** → **Data usage** → **Allowed networks for apps**. Tap an app you want from the apps list and select a network option.

-  You may incur additional charges when using the mobile data.

Mobile Hotspot

Use your phone as a mobile hotspot to share your phone's mobile data connection with other devices.

- 1 On the Settings screen, tap **Connections** → **Mobile Hotspot and Tethering** → **Mobile Hotspot**.
 - 2 Tap the switch to turn it on.
You can change the network name, password, and more.
The Hotspot icon () appears on the status bar.
 - 3 On the other device's screen, search for and select your phone from the Wi-Fi networks list.
Alternatively, tap **QR code** on the Mobile Hotspot screen and scan the QR code with the other device.
-  • If the mobile hotspot is not found, on your phone, set **Band** to **2.4 GHz**, tap **Advanced**, and then tap the **Hidden network** switch to turn it off.
 - If you turn on the **Auto Hotspot** feature, you can share your phone's mobile data connection with other devices signed in to your Samsung account.

More connection settings

Customise settings to control other connection features.

On the Settings screen, tap **Connections** → **More connection settings**.

- **Nearby device scanning:** Set the phone to scan for nearby devices to connect to.
- **Printing:** Configure settings for printer plug-ins installed on the device. You can search for available printers or add one manually to print files. Refer to [Printing](#) for more information.
- **VPN:** Set up virtual private networks (VPNs) on your device to connect to a school or company's private network.
- **Private DNS:** Set the device to use the security enhanced private DNS.
- **Ethernet:** When you connect an Ethernet adapter, you can use a wired network and configure network settings.
- **Auto update system configurations:** Allow automatic configuration changes to ensure that network connection features work as expected.

Printing

Configure settings for printer plug-ins installed on the device. You can connect the device to a printer through Wi-Fi or Wi-Fi Direct, and print images or documents.

 Some printers may not be compatible with the device.

Adding printer plug-ins

Add printer plug-ins for printers you want to connect the device to.

1 On the Settings screen, tap **Connections** → **More connection settings** → **Printing** → **Download plugin**.

2 Select a printer plug-in and install it.

3 Select the installed printer plug-in.

The device will automatically search for printers that are connected to the same Wi-Fi network as your device.

4 Select a printer to add.

 To add printers manually, tap the More options icon (⋮) → **Add printer**.

Printing content

While accessing content, such as images or documents, access the options list, tap **Print** → the Dropdown icon (▼) → **All printers...**, and then select a printer.

 Printing methods may vary depending on the content type.

Connected devices

Change settings for device connections.

On the Settings screen, tap **Connected devices**.

- **Quick Share:** Change the Quick Share settings. Refer to [Quick Share](#) for more information.
- **Music Share:** Change the Music Share settings. Refer to [Music Share](#) for more information.
- **Auto switch Buds:** Set the Galaxy Buds to switch from another device to your phone when you make or answer a call, play media, and more. You can use this feature only when you signed in to the same Samsung account on the other device and you are wearing your Galaxy Buds.
- **Call & text on other devices:** Connect your tablet and phone to use calling and messaging features on the tablet with your phone number. You must register and sign in to the same Samsung account on the tablet and phone. Some calling and messaging features may not be available.
- **Continue on other devices:** Use your phone's apps and features on other devices signed in to your Samsung account.
- **Camera Share:** Use your phone's camera as a webcam for a nearby tablet or Galaxy Book. To use this feature, both devices need to be signed in to the same Samsung account and have Wi-Fi, Bluetooth, and the Camera Share feature turned on.
- **Storage Share:** Share your phone's files with your Samsung TV or Galaxy Book. To use this feature, both devices need to be signed in to the same Samsung account and have Wi-Fi, Bluetooth, and the Storage Share feature turned on.
- **Link to Windows:** Access and use the mobile device's data, such as apps or pictures, on a Windows computer. A Microsoft account is required to use this feature. Visit <https://aka.ms/setup1tw> for details.
- **Multi control:** Use a mouse and keyboard connected to a Samsung computer that supports this feature on your phone.
- **Samsung DeX:** Use your mobile device's features in an interface environment similar to a computer. Refer to [Samsung DeX](#) for more information.
- **Smart View:** View your phone's displayed content on a large screen by connecting your phone to a screen mirroring-enabled TV or monitor. Refer to [Smart View](#) for more information.

- **Galaxy Wearable:** When you connect your phone to the wearable device, you can customise the wearable device's settings and apps. Refer to [Galaxy Wearable](#) for more information.
- **SmartThings:** Control and manage smart appliances and Internet of Things (IoT) products. Refer to [SmartThings](#) for more information.
- **Android Auto:** Connect your device to a vehicle and control some of your device's features on the vehicle's display.



Some features may not be available depending on the model.

Galaxy AI

Use advanced intelligence features to help you use your device.

On the Settings screen, tap **Galaxy AI**. Refer to [Galaxy AI](#) for more information.

Modes and Routines

Using modes

Add a mode based on your current activity or location. Your device's settings will change to match your activity or situation. You can turn the mode on or off from the quick settings panel.

Adding modes

- 1 On the Settings screen, tap **Modes and Routines** → **Modes**.
- 2 Select a mode you want or tap **Add mode** to add your own modes.

Running modes

Modes will run automatically when their conditions are detected. You can also run them manually by tapping the button whenever you want.

To run modes manually, select the mode you want and tap **Turn on**.

To turn off a running mode, tap the mode and tap **Turn off**.

Alternatively, open the quick settings panel, tap **Modes**, and then select a mode to turn it on. To turn the mode off, tap the mode button on the quick settings panel.

Using routines

Automate your repetitive daily tasks. For example, you can automatically change your sound settings depending on where you are, optimise your device's settings for gaming, and more.

Adding routines

- 1 On the Settings screen, tap **Modes and Routines** → **Routines**.
- 2 Tap the Create icon (+) and add your own routines or tap **Discover** and select a routine you want.
If you want to set the routine's running condition to manual, tap **Start manually**. This option will appear only when there are no running conditions set.

Running routines

Auto routines will run automatically when their conditions are detected. For routines which you set the running condition as **Start manually**, you can run them manually by tapping the button whenever you want.

To run routines manually, tap the Start icon (▶) next to the routine you want to run. If you want to use a widget, tap a routine under **Manual routines** and tap **More** → **Set as widget** → **Add**. The routine will be added as a widget to the Home screen and you can run the routine by tapping the widget.

To stop running routines, tap the Routine list icon (⋄), tap the routine under **Running**, and then tap **Stop**, or tap the routine's widget on the Home screen.

Sounds and vibration

Options

Change settings for various sounds on the device.

On the Settings screen, tap **Sounds and vibration**.

- **Sound / Vibrate / Mute**: Set the device to use sound mode, vibration mode, or silent mode.
- **Vibrate while ringing**: Set the device to vibrate and play a ringtone for incoming calls.
- **Temporary mute**: Set the device to use silent mode for a certain period.
- **Ringtone**: Change the call ringtone.
- **Notification sound**: Change the notification sound.
- **System sound**: Change the sound to use for certain actions, such as charging the device.
- **Volume**: Adjust the device's volume level.
- **Call vibration**: Change the call vibration settings.
- **Notification vibration**: Change the notification vibration settings.
- **System vibration**: Select actions to receive vibration feedback and adjust the vibration intensity.
- **Vibration intensity**: Adjust the force of the vibration notification.
- **Sound quality and effects**: Set the device's sound quality and effects. Refer to [Sound quality and effects](#) for more information.
- **Separate app sound**: Set the device to play media sound from a specific app separately on the other audio device. Refer to [Separate app sound](#) for more information.



Some features may not be available depending on the model.

Sound quality and effects

Set the device's sound quality and effects.

On the Settings screen, tap **Sounds and vibration** → **Sound quality and effects**.

- **Dolby Atmos:** Select a surround sound mode optimised for various types of audio, such as movies, music, and voice. With Dolby Atmos, you can experience moving audio sounds that flow all around you.
- **Equaliser:** Change the sound profile and enjoy optimised sound.
- **Loudness normalisation:** Reduce the differences in volume between different content. The device will automatically increase the volume of content with low volume.
- **App sound settings:** Check and manage the optimised sound settings you saved for each media app. To adjust sound settings for each app, open the quick settings panel while playing content in the app, touch and hold the volume adjustment bar, and then change the settings. The same settings will be applied the next time you run the app.
- **Adapt sound:** Set the best sound for you.
- **UHQ upscaler:** Enhance the sound resolution of music and videos when using wired headphones or Bluetooth headphones that support UHQ.



Depending on the model, you must connect headphones to use some features.

Separate app sound

Set the device to play media sound from a specific app on the connected Bluetooth speaker or headset.

For example, you can listen to the Navigation app through your device's speaker while listening to playback from the Music app through the vehicle's Bluetooth speaker.

- 1 On the Settings screen, tap **Sounds and vibration** → **Separate app sound** and tap the switch to turn it on.
- 2 Select an app to play media sounds separately and tap the Back button (<).
- 3 Select a device for playing the selected app's media sound.

Notifications

Change the notification settings.

On the Settings screen, tap **Notifications**.

- **App notifications:** Select the apps you want to receive notifications from.
- **Lock screen notifications:** Set how to show notifications on the locked screen.
- **Status bar:** Set how to display notification icons and whether to display the remaining battery percentage on the status bar.
- **Notification pop-up style:** Select a notification pop-up style and change the settings.
- **Do not disturb:** Set the device to mute all sounds except for allowed exceptions.
- **Advanced settings:** Configure advanced settings for notifications.

Display

Options

Change the display and the Home screen settings.

On the Settings screen, tap **Display**.

- **Light / Dark:** Turn Dark mode on or off.
- **Dark mode settings:** Reduce eye strain by applying the dark theme when using the device at night or in a dark place. You can set a schedule for applying Dark mode.
 The dark theme may not be applied in some apps.
- **Brightness:** Adjust the brightness of the display.
- **Adaptive brightness:** Set the device to keep track of your brightness adjustments and apply them automatically in similar lighting conditions.
- **Extra brightness:** Set the display to be brighter than the maximum brightness. This feature is available when you turn off the **Adaptive brightness** feature.
- **Motion smoothness:** Change the refresh rate of the screen. When a high refresh rate is set, the screen will scroll more smoothly. Refer to [Motion smoothness](#) for more information.

- **Eye comfort shield:** Reduce eye strain by limiting the amount of blue light emitted by the screen. You can set a schedule for applying this feature.
- **Adaptive colour tone:** Adjust the colours and white balance based on the ambient lighting conditions to make colours appear more natural in different environments.
- **Screen mode:** Change the screen mode to adjust the display's colour and contrast. Refer to [Changing the screen mode or adjusting the display colour](#) for more information.
- **Font size and style:** Change the font size and style.
- **Screen zoom:** Make the items on the screen larger or smaller.
- **Screen resolution:** Change the screen resolution. Higher resolutions make the display more vivid, however they will consume more battery power. Some currently running apps may close when you change the resolution.
- **Camera cutout:** Set the device to hide the front camera from the screen.
- **Screen timeout:** Set the length of time the device waits before turning off the display's backlight.
- **Easy mode:** Switch to easy mode to display larger icons and apply a simpler layout to the Home screen.
- **Edge panels:** Change the settings for the Edge panel.
- **Navigation bar:** Change the navigation bar settings. Refer to [Navigation bar \(soft buttons\)](#) for more information.
- **Accidental touch protection:** Set the device to prevent the screen from detecting touch input when it is in a dark place, such as a pocket or bag.
- **Touch sensitivity:** Increase the touch sensitivity of the screen for use with screen protectors.
- **Show charging information:** Set the device to display the charging information, such as the remaining battery percentage when the screen is off.
- **Screen saver:** Set the device to launch a screensaver when the device is charging.



Some features may not be available depending on the model.

Motion smoothness

The refresh rate is the number of times the screen is refreshed every second. Use a high refresh rate to prevent the screen from flickering when switching between screens. The screen will scroll more smoothly. When you select a standard refresh rate, you can use the battery longer.

- 1 On the Settings screen, tap **Display** → **Motion smoothness**.
- 2 Select a refresh rate.
 - **Adaptive:** Get smoother animations and scrolling by automatically adjusting your screen refresh rate into a higher one.
 - **Standard:** Use a standard refresh rate in normal situations to conserve battery power.

Changing the screen mode or adjusting the display colour

Change the screen mode or adjust the display colour to your preference.

Changing the screen mode

On the Settings screen, tap **Display** → **Screen mode** and select a mode you want.

- **Vivid:** This optimises the colour range, saturation, and sharpness of your display. You can also adjust the display colour balance by colour value.
 - **Natural:** This adjusts the screen to a natural tone.
-  • You can adjust the display colour only in **Vivid** mode.
- **Vivid** mode may not be compatible with third-party apps.

Optimising the full screen colour balance

Optimise the display colour by adjusting the colour tones to your preference.

On the Settings screen, tap **Display** → **Screen mode** → **Vivid** and adjust the colour adjustment bar under **White balance**.

When you drag the colour adjustment bar towards **Cool**, the blue colour tone will increase. When you drag the bar towards **Warm**, the red colour tone will increase.

Adjusting the screen tone by colour value

Increase or lower certain colour tones by adjusting the Red, Green, or Blue value individually.

- 1 On the Settings screen, tap **Display** → **Screen mode** → **Vivid**.
- 2 Tap **Advanced settings**.
- 3 Adjust the **R** (Red), **G** (Green), or **B** (Blue) colour bar to your preference. The screen tone will be adjusted.
To adjust the vividness level, drag the bar under **Vividness**.

Battery

Check the remaining battery power and time to use the device. For devices with low battery levels, conserve battery power by turning on power saving features.

On the Settings screen, tap **Battery**.

- **Power saving:** Turn on power saving mode to extend the battery's usage time.
- **Background usage limits:** Limit battery usage for apps that you do not use often.
- **Battery protection:** Set to stop charging when the battery is fully charged or limit the maximum charge to the preset level.
- **Today:** Check the battery level and usage history.
- **Charging settings:** Configure the charging settings.
- **Wireless power sharing:** Charge another device with your phone's battery. Refer to [Wireless power sharing](#) for more information.
- **Auto dim screen:** Dim the screen when the remaining battery power drops below a certain level.
- **Show battery percentage:** Display the remaining battery percentage on the status bar.
- **Battery information:** Check out battery information.



- The usage time left shows the time remaining before the battery power runs out. Usage time left may vary depending on your device settings and operating conditions.
- You might not receive notifications from some apps that use power saving mode.
- You can check the following battery information here. The available information may vary depending on the region or service provider.
 - Date of battery manufacturing
 - Date of first use
 - Number of full charge/discharge cycles (based on rated capacity)
 - Measured state of health

Wallpaper and style

Change the wallpaper settings for the Home screen and the locked screen.

On the Settings screen, tap **Wallpaper and style**.

Themes

Apply various themes to the device to change the visual elements of the Home screen, locked screen, and icons.

On the Settings screen, tap **Themes**.

Home screen

Configure settings for the Home screen, such as the screen layout.

On the Settings screen, tap **Home screen**.

Lock screen and AOD

Options

Change the settings for the locked screen and the Always On Display.

On the Settings screen, tap **Lock screen and AOD**.

- **Screen lock and biometrics:** Change the screen lock method.
 - **Extend Unlock:** Set the device to unlock itself when trusted locations or devices are detected. Refer to [Extend Unlock](#) for more information.
 - **Secure lock settings:** Change screen lock settings for the selected lock method.
 - **Always On Display:** Set the device to display information while the screen is turned off. Refer to [Always On Display](#) for more information.
 - **Now bar:** Select items to display on the locked screen.
 - **Touch and hold to edit:** Set the device to display the editing options when you touch and hold the locked screen.
 - **Roaming clock:** Change the clock to show both the local and home time zones on the locked screen when roaming.
 - **Contact information:** Set the device to show contact information, such as your email address, on the locked screen.
 - **Show unlock transition effect:** Set to display the unlock transition effect when you unlock the screen through your biometric data.
 - **About Lock screen:** Check out the Lock screen version and legal information.
-  • Some features may not be available depending on the carrier or model.
- The available options may vary depending on the screen lock method selected.

Extend Unlock

You can set the device to unlock itself and remain unlocked when trusted locations or devices are detected.

For example, if you have set your home as a trusted location, when you get home your device will detect the location and automatically unlock itself.

On the Settings screen, tap **Lock screen and AOD** → **Extend Unlock** and follow the on-screen instructions to complete the setup.

-  • This feature will be available to use after you set a screen lock method.
- If you do not use your device for four hours or when you turn on the device, you must unlock the screen using the pattern, PIN, or password you set.

Always On Display

(Displaying information when the screen is turned off)

You can check out information on the screen, such as the clock, when it is turned off.

You can also check notifications for new messages or missed calls.

To set the Always On Display to appear only during the preset condition, on the Settings screen, tap **Lock screen and AOD** → **Always On Display** → **When to show**, and then select an option you want.

-  The brightness of the Always On Display may change automatically depending on the lighting conditions.

Opening notifications on the Always On Display

When you receive message, missed call, or app notifications, notification icons will appear on the Always On Display. Double tap a notification icon to check its notification.

To use this feature, on the Settings screen, tap **Notifications** → **Lock screen notifications** and tap **Cards** under **Notification style**.

-  If the screen is locked, you must unlock it to check notifications.

Turning off the Always On Display feature

On the Settings screen, tap **Lock screen and AOD** and tap the **Always On Display** switch to turn it off.

Security and privacy

Options

Check the device's security and privacy status and change the settings.

On the Settings screen, tap **Security and privacy**.

- **Lock screen:** Change the settings for the locked screen.
- **Account security:** Change the settings for your accounts.
- **Lost device protection:** Turn the Find My Mobile feature on or off. Access smarthingsfind.samsung.com to track and control your lost or stolen phone. You can also check the location of the wearable devices connected to this phone.
- **App security:** Scan apps and keep your device safe from malicious software.
- **Updates:** Check the version of your device's software and check for updates.
- **Screen lock and biometrics:** Change the settings for the locked screen and biometric data. Refer to [Face recognition](#) and [Fingerprint recognition](#) for more information.
- **Auto Blocker:** Keep your device safe by blocking threats and other suspicious activity.
- **Security status of your devices:** Check the security status of your devices that are signed in to your Samsung account.
- **More security settings:** Configure additional security settings. Refer to [Secure Wi-Fi](#), [Secure Folder](#), and [Samsung Pass](#) for more information.
- **Permissions used in last 24 hours:** Check the app or feature's permission usage history.
- **Internet privacy protection:** Check the internet privacy protection history and change settings. This feature will be added when you use the **Samsung Internet** app.
- **Controls and alerts:** Control access to features such as the microphone and clipboard.
- **More privacy settings:** Configure additional privacy settings.



Some features may not be available depending on the carrier or model.

Face recognition

You can set the device to unlock the screen by recognising your face.

-  • If you use your face as a screen lock method, your face cannot be used to unlock the screen for the first time after turning on the device. To use the device, you must unlock the screen using the pattern, PIN, or password you set when registering the face. Be careful not to forget your pattern, PIN, or password.
- If you change the screen lock method to **Swipe** or **None**, which are not secure, all of your biometric data will be deleted.

Precautions for using face recognition

Before using the face recognition to unlock your device, keep the following precautions in mind.

- Your device could be unlocked by someone or something that looks like your image.
- Face recognition is less secure than Pattern, PIN, or Password.

For better face recognition

Consider the following when using face recognition:

- Consider the conditions when registering, such as wearing glasses, hats, masks, beards, or heavy makeup
- Ensure that you are in a well-lit area and that the camera lens is clean when registering
- Ensure your image is not blurry for better match results

Registering your face

For better face registration, register your face indoors and out of direct sunlight.

- 1 On the Settings screen, tap **Security and privacy** → **Screen lock and biometrics** → **Face recognition**.
- 2 Set a screen lock method.

- 3 Read the on-screen instructions and tap **Continue**.
 - 4 Tap **Register** and position your face inside the frame on the screen.
The camera will scan your face.
-  • If unlocking the screen with your face is not working properly, tap **Remove face data** to remove your registered face and register your face again.
 - To enhance the face recognition, tap **Add alternative appearance to enhance recognition** and add an alternate appearance.

Unlocking the screen with your face

You can unlock the screen with your face instead of using a pattern, PIN, or password.

- 1 On the Settings screen, tap **Security and privacy** → **Screen lock and biometrics**.
- 2 Unlock the screen using the preset screen lock method.
- 3 Tap **Face recognition** and tap the **Face unlock** switch to turn it on.
- 4 On the locked screen, look at the screen.
When your face is recognised, you can unlock the screen without using any additional screen lock method. If your face is not recognised, use the preset screen lock method.

Deleting the registered face data

You can delete face data that you have registered.

- 1 On the Settings screen, tap **Security and privacy** → **Screen lock and biometrics**.
- 2 Unlock the screen using the preset screen lock method.
- 3 Tap **Face recognition** → **Remove face data** → **Remove**.
Once the registered face is deleted, all the related features will also be turned off.

Fingerprint recognition

In order for fingerprint recognition to function, your fingerprint information needs to be registered and stored in your device.



- This feature may not be available depending on the carrier or model.
- Fingerprint recognition uses the unique characteristics of each fingerprint to enhance the security of your device. The likelihood of the fingerprint sensor confusing two different fingerprints is very low. However, in rare cases where separate fingerprints are very similar the sensor may recognise them as identical.
- Thick protective film can affect performance. If you use a screen protector, check to make sure it's labeled as compatible with the on-screen fingerprint sensor. (such as screen protectors sold by Samsung)
- If you use your fingerprint as a screen lock method, your fingerprint cannot be used to unlock the screen for the first time after turning on the device. To use the device, you must unlock the screen using the pattern, PIN, or password you set when registering the fingerprint. Be careful not to forget your pattern, PIN, or password.
- If your fingerprint is not recognised, unlock the device using the pattern, PIN, or password you set when registering the fingerprint, and then re-register your fingerprints. If your pattern, PIN, or password is forgotten, you will not be able to use the device if you do not reset it. Samsung is not responsible for any data loss or inconvenience caused by forgotten unlock codes.
- If you change the screen lock method to **Swipe** or **None**, which are not secure, all of your biometric data will be deleted.

For better fingerprint recognition

When you scan your fingerprints on the device, be aware of the following conditions that may affect the feature's performance:

- The device may not recognise fingerprints that are affected by wrinkles or scars.
- The device may not recognise fingerprints from small or thin fingers.
- To improve recognition performance, register the fingerprints of the fingers used most often to perform tasks on the device.

- Your device has a built-in fingerprint recognition sensor at the bottom centre of the screen. Ensure that the screen protector or the screen on the fingerprint recognition sensor area is not scratched or damaged by objects, such as coins, keys, pens, and necklaces.
- Ensure that the fingerprint recognition sensor area at the bottom centre of the screen and your fingers are clean and dry.
- If you bend your finger or use a fingertip, the device may not recognise your fingerprints. Press the screen so that your fingertip spreads over the wide surface of the fingerprint recognition area.

Registering fingerprints

On the Settings screen, tap **Security and privacy** → **Screen lock and biometrics** → **Fingerprints** and follow the on-screen instructions to register your fingerprint. After registering, you can check whether your fingerprint is registered and its name by tapping **Check added fingerprints**.

Unlocking the screen with your fingerprints

You can unlock the screen with your fingerprint instead of using a pattern, PIN, or password.

- 1 On the Settings screen, tap **Security and privacy** → **Screen lock and biometrics**.
- 2 Unlock the screen using the preset screen lock method.
- 3 Tap **Fingerprints** and tap the **Fingerprint unlock** switch to turn it on.
- 4 On the locked screen, place your finger on the fingerprint recognition sensor and scan your fingerprint.

Recognising your fingerprints with the screen turned off

- 1 On the Settings screen, tap **Security and privacy** → **Screen lock and biometrics**.
- 2 Unlock the screen using the preset screen lock method.
- 3 Tap **Fingerprints** and tap the **Fingerprint always on** switch to turn it on.
If you tap **Show icon when screen is off**, you can change when to show the fingerprint recognition icon or set it to not display the icon.

Deleting registered fingerprints

You can delete registered fingerprints.

- 1 On the Settings screen, tap **Security and privacy** → **Screen lock and biometrics**.
- 2 Unlock the screen using the preset screen lock method.
- 3 Tap **Fingerprints**, select a fingerprint to delete, and then tap **Remove**.

Secure Wi-Fi

Secure Wi-Fi is a service that secures your Wi-Fi network connection. It encrypts data using Wi-Fi networks and disables tracking apps and websites so that you can use Wi-Fi networks safely. For example, when using an unsecure Wi-Fi network in public places, such as cafes or airports, Secure Wi-Fi is automatically turned on so that no one can hack your login information or monitor your activity in apps and websites.

On the Settings screen, tap **Security and privacy** → **More security settings** → **Secure Wi-Fi** and follow the on-screen instructions to complete the setup. If you tap **Protection activity**, you can check the history of how and when your network was protected with Secure Wi-Fi.

When Secure Wi-Fi is turned on, the VPN icon (🔒) will appear on the status bar.



- Using this feature may result in a slower Wi-Fi network speed.
- This feature may not be available depending on the Wi-Fi network, carrier, or model.

Selecting apps to protect using Secure Wi-Fi

Select apps to protect using Secure Wi-Fi so that you can safely protect data, such as your password or your activity in apps, from being accessed by others.

On the Settings screen, tap **Security and privacy** → **More security settings** → **Secure Wi-Fi** → the More options icon (⋮) → **Settings** → **Protected apps** and tap the switches next to the apps you want to protect using Secure Wi-Fi.



Some apps may not support this feature.

Purchasing protection plan

You are provided with a free protection plan for Wi-Fi networks every month. You can also purchase paid protection plans and have unlimited bandwidth protection for a limited time.

- 1 On the Settings screen, tap **Security and privacy** → **More security settings** → **Secure Wi-Fi**.
- 2 Tap **Protection plan** → **Upgrade** and select the plan you want.
 For certain protection plans, you can transfer the protection plan to another device signed in to your Samsung account.
- 3 Follow the on-screen instructions to complete the purchase.

Secure Folder

Secure Folder protects your private content and apps, such as pictures and contacts, from being accessed by others. You can keep your private content and apps secure even when the device is unlocked.

-  Secure Folder is a separate, secured storage area. The data in Secure Folder cannot be transferred to other devices through unapproved sharing methods, such as USB or Wi-Fi Direct. Attempting to customise the operating system or modifying software will cause Secure Folder to be automatically locked and inaccessible. Before saving data in Secure Folder, make sure to back up a copy of the data in another secure location.



Setting up Secure Folder

- 1 Open **Settings** and tap **Security and privacy** → **More security settings** → **Secure Folder**.

2 Follow the on-screen instructions to complete the setup.



When a pop-up window asking whether you want to reset the Secure Folder lock type with your Samsung account appears, tap **Allow**. If you have forgotten the lock type, you can reset it using your Samsung account. If you do not turn on this feature, you cannot reset the lock type when you have forgotten it.

When the setup is complete, the Secure Folder screen will appear and the Secure Folder app icon () will be added to the Apps screen.

-  • When the **Secure Folder** app is locked, you must unlock it using your preset lock method.
- To change the name or icon of Secure Folder, tap the More options icon () → **Customise**.

Setting an auto lock condition for Secure Folder

- 1 Open the **Secure Folder** app and tap the More options icon () → **Settings** → **Auto lock Secure Folder**.
- 2 Select a lock option.

-  To manually lock your Secure Folder, tap the More options icon () → **Lock and exit**.

Moving content to Secure Folder

Move content, such as pictures and videos, to Secure Folder. The following actions are an example of moving an image from the default storage to Secure Folder.

- 1 Open the **Secure Folder** app and tap the More options icon () → **Add files**.
- 2 Tap **Images**, tick images to move, and then tap **Done**.
- 3 Tap **Move**.

The selected items will be deleted from the original folder and moved to Secure Folder. To copy items, tap **Copy**.

-  The method for moving content may vary depending on the content type.

Moving content from Secure Folder

Move content from Secure Folder to the corresponding app in the default storage. The following actions are an example of moving an image from Secure Folder to the default storage.

- 1 Open the **Secure Folder** app and tap **Gallery**.
- 2 Select an image and tap the More options icon (⋮) → **Move out of Secure Folder**.
The selected items will be moved to **Gallery** in the default storage.

Adding apps

Add an app to use in Secure Folder.

- 1 Open the **Secure Folder** app and tap the Add apps icon (+).
- 2 Tick one or more apps installed on the device and tap **Add**.

Removing apps from Secure Folder

Touch and hold an app to delete, and tap **Uninstall**.

Adding accounts

Add your Samsung and Google accounts, or other accounts, to sync with the apps in Secure Folder.

- 1 Open the **Secure Folder** app and tap the More options icon (⋮) → **Settings** → **Manage accounts** → **Add account**.
- 2 Select an account service.
- 3 Follow the on-screen instructions to complete the account setup.

Hiding Secure Folder

You can hide the Secure Folder shortcut from the Apps screen.

Open the **Secure Folder** app, tap the More options icon (⋮) → **Settings**, and then tap the **Add Secure Folder to Apps screen** switch to turn it off.

If you want to show the Secure Folder again, open **Settings**, tap **Security and privacy** → **More security settings** → **Secure Folder**, unlock the screen using the preset screen lock method, and then tap the **Add Secure Folder to Apps screen** switch to turn it on.

Uninstalling Secure Folder

You can uninstall Secure Folder, including the content and apps in it.

Open the **Secure Folder** app and tap the More options icon (⋮) → **Settings** → **More settings** → **Uninstall**.

To back up content before uninstalling Secure Folder, tick **Move media files out of Secure Folder** and tap **Uninstall**. To access data backed up from Secure Folder, open the **My Files** app and tap **Internal storage** → **Download** → **Secure Folder**.

 Notes saved in **Samsung Notes** will not be backed up.

Samsung Pass

Verify your identity with Samsung Pass when using services which require your login or personal information.

Registering Samsung Pass

On the Settings screen, tap **Security and privacy** → **More security settings** → **Passwords, passkeys, and autofill** → **Samsung Pass**. Follow the on-screen instructions to complete the setup.

Saving your information to Samsung Pass

When you save apps' or websites' sign-in or personal information in Samsung Pass, you can enter the information automatically.

 You can save your information manually or check and manage the saved information on Samsung Pass.

Saving your sign-in information

On the sign-in page of the app or website, enter your ID and password, and then tap the sign-in button. When a pop-up window asking whether you want to save the sign-in information appears, tap **Save**.

Saving your personal information

On the Samsung Pass main screen, select an option under **Private info**, enter the information, and then tap **Save**.

Entering your information automatically

You can automatically enter your sign-in or personal information, such as your address or payment card information, saved in Samsung Pass.



- This feature may not be available in some apps or websites.
- The website autofill feature is only available for websites that you access through the **Samsung Internet** app.

Signing in using passkeys

In apps or websites that support sign-in with a passkey, you can sign in with a passkey saved in Samsung Pass instead of the sign-in information.

- 1 On the app or website you are using, create a passkey.
The method for creating a passkey may differ depending on the app or website.
- 2 When a pop-up window asking whether you want to save the passkey appears, select Samsung Pass and follow the on-screen instructions to save the passkey.
Now you can sign in with the passkey saved in Samsung Pass.

Location

Change settings for location information permissions.

On the Settings screen, tap **Location**.

- **App permissions:** Check the list of apps that have permission to access the device's location and edit the permission settings.
- **Location services:** Set the device to use the Wi-Fi or Bluetooth feature to increase the accuracy of your location information, even when the features are turned off. You can also check the location services your device is using.
- **Recent access:** Check which apps request your current location information.

Safety and emergency

Manage your medical information and emergency contacts. You can also change settings for emergency features, such as wireless emergency alerts.

On the Settings screen, tap **Safety and emergency**.

- **Medical info:** Enter your medical information.
- **Emergency contacts:** Add your emergency contacts.
- **Emergency SOS:** Make an emergency call to the preset number when you press the Side button several times as specified on the settings screen of this feature.
- **Emergency sharing:** Set the device to send information, such as your location or your device's lower battery notifications, to your emergency contacts for a certain period of time.
- **Silence notifications while driving:** Turn on the Do Not Disturb feature automatically while driving.
- **Emergency Location Service:** Turn on the Emergency Location Service (ELS) feature.
- **Wireless emergency alerts:** Change the settings for wireless emergency alerts.
- **Earthquake alerts:** Turn on the earthquake alert feature.
- **Unknown tracker alerts:** You will receive a notification if an unknown tracker has been detected travelling with you.



Some features may not be available depending on the region or the model.

Accounts and backup

Options

Sync, back up, or restore your device's data using Samsung Cloud. You can also sign in to accounts, such as your Samsung account or Google Account, or transfer data to or from other devices through Smart Switch.

On the Settings screen, tap **Accounts and backup**.

- **Manage accounts:** Add your Samsung and Google accounts, or other accounts, to sync with.
- **Samsung Cloud:** Back up your data and settings, and restore the previous device's data and settings even when you do not have it. Refer to [Samsung Cloud](#) for more information.
- **Google Drive:** Keep your personal information, app data, and settings safe on your device. You can back up your sensitive information. You must sign in to your Google Account to back up data.
- **Smart Switch:** Open Smart Switch and transfer data from your previous device. Refer to [Transferring data from your previous device \(Smart Switch\)](#) for more information.



Regularly back up your data to a safe location, such as Samsung Cloud or a computer, so that you can restore it if the data is damaged or lost because of an unintended factory data reset.

Samsung Cloud

Back up your device's data to Samsung Cloud and restore it later.

Backing up data

You can back up your device's data to Samsung Cloud.

- 1 On the Settings screen, tap **Accounts and backup** and tap **Back up data** under **Samsung Cloud**.
- 2 Tap the switches next to the items you want to back up and tap **Back up now**.

3 Tap **Done**.



- Some data will not be backed up. To check which data will be backed up, on the Settings screen, tap **Accounts and backup** and tap **Back up data** under **Samsung Cloud**.
- To check the backup data for other devices in your Samsung Cloud, on the Settings screen, tap **Accounts and backup** → **Restore data**, and then select a device you want.

Restoring data

You can restore your backup data from Samsung Cloud to your device.

- 1 On the Settings screen, tap **Accounts and backup**.
- 2 Tap **Restore data** and select a device you want.
- 3 Tick items you want to restore and tap **Restore**.

Google

Configure settings for some features provided by Google.



On the Settings screen, tap **Google**.

Advanced features

Options

Turn on advanced features and change the settings that control them.

On the Settings screen, tap **Advanced features**.

- **Bixby:** Bixby is a user interface that helps you use your device more conveniently. Refer to [Bixby](#) for more information.
- **Labs:** Use new features of the device.
- **S Pen:** Change the settings for using the S Pen. Refer to [S Pen \(Galaxy S24 Ultra\)](#) for more information.
- **Side button:** Select an app or feature to launch using the Side button. Refer to [Setting the Side button](#) for more information.
- **Multi window:** Set how to launch Multi window. You can also configure settings for Multi window. Refer to [Multi window](#) for more information.
- **Motions and gestures:** Turn on the motion feature and configure settings. Refer to [Motions and gestures](#) for more information.
- **One-handed mode:** Turn on one-handed operation mode for your convenience when using the device with one hand.
- **Screenshots and screen recordings:** Change the settings for screenshots and screen recorder.
- **Video effects:** Set to use various effects, such as changing the background while using the camera in certain apps. Refer to [Video effects](#) for more information.
 This feature is only available in some apps.
- **Video brightness:** Increase the screen brightness and make colours more vibrant when you play videos.
 This feature may not be available in some apps.
- **Super HDR:** Set to adjust the display to show the full range of colours and contrast in pictures taken with Galaxy devices.
- **Game Booster settings:** Configure settings for Game Booster.

- **Galaxy Avatar:** Create avatars any way you want and have fun using them in various features. Refer to [Galaxy Avatar](#) for more information.
- **Dual Messenger:** Install the second app and use two separate accounts for the same messenger app. Refer to [Dual Messenger](#) for more information.

 Some features may not be available depending on the carrier or model.

Motions and gestures

Turn on the motion feature and configure settings.

On the Settings screen, tap **Advanced features** → **Motions and gestures**.

- **Lift to wake:** Set the device to turn on the screen when you pick it up.
- **Double tap to turn on screen:** Set the device to turn on the screen by double tapping anywhere on the screen while the screen is turned off.
- **Double tap to turn off screen:** Set the device to turn off the screen by double tapping an empty area on the Home screen or the locked screen.
- **Alert when phone picked up:** Set the device to alert you if you have missed calls or new messages when you pick up the device.

 This feature may not work if the screen is turned on or the device is not on a flat surface.



- **Mute with gestures:** Set the device to mute certain sounds by using motions or gestures.
- **Palm swipe to capture:** Set the device to capture a screenshot when you swipe your hand to the left or right across the screen. You can check the captured images in **Gallery**. It is not possible to capture a screenshot while using some apps and features.

 Excessive shaking or an impact to the device may cause an unintended input for some features using sensors.

Video effects

You can use various features, such as changing the background while using the camera in certain apps.

While using the camera in apps that support this feature, open the quick settings panel and tap **Video effects**.

-  : Reset the settings.
 -  : Select or add background colours or images to use.
 - **Background**: Change or blur the background.
 - **Face**: Apply beauty effects to the face.
 - **Colour tone**: Adjust the screen's colour tone and brightness.
 - **Auto framing**: Turn the auto framing feature on or off. When you turn on this feature, the device changes the shooting angle and zoom automatically by recognising and tracking people.
-  • Some features may not be available depending on the model.
- Some features are available only when using the front camera.

Galaxy Avatar

Create avatars any way you want and have fun using them in various features.

On the Settings screen, tap **Advanced features** → **Galaxy Avatar**. If you added the app icon to the Apps screen, open the **Galaxy Avatar** app.

Creating a Galaxy Avatar

Launch Galaxy Avatar, tap the Create icon () , and then follow the on-screen instructions to create an avatar.

Using Galaxy Avatar stickers

When you create avatars, stickers with avatar expressions and actions will be created automatically. You can use your avatar stickers when sending messages or on a social network.

Launch Galaxy Avatar and tap **Avatar Stickers**. To create your own stickers, tap the Make custom stickers icon () at the top of the stickers list.

Using the Galaxy Avatar camera

Create fun pictures or videos with avatars using various shooting modes.

Launch Galaxy Avatar and tap **Avatar Camera**. Select the avatar and the mode you want to use, then take a picture or record a video.

Dual Messenger

Install the second app and use two separate accounts for the same messenger app.

1 On the Settings screen, tap **Advanced features** → **Dual Messenger**.

Supported apps will appear.

2 Tap the switch of an app to install the second app.

The second app will be installed. The second app's icon will be displayed with the Second app icon (.



- The Dual Messenger feature may not be available depending on the app.
- Some features of the app may be limited for the second app.

Uninstalling a second app

1 On the Settings screen, tap **Advanced features** → **Dual Messenger**.

2 Tap the switch of the app you want to uninstall and tap **Uninstall**.

All data related to the second app will be deleted.



If you uninstall the first app, the second app will also be deleted.

Digital Wellbeing and parental controls

Check the history of your device usage and use features to prevent your device from interfering with your life. You can also set up parental controls for your children and manage their digital use.

On the Settings screen, tap **Digital Wellbeing and parental controls**.

- **Most used app categories:** Check out the list of the most used app categories for a day.
- **Screen time goal:** Set goals for how much you use your device a day.
- **App timers:** Limit the daily usage time for each app by setting a timer. When you reach the limit, the app will be turned off and you cannot use it.
- **Driving monitor:** Turn on the driving monitor to monitor the amount of the time you use your device while driving.
- **Walking monitor:** Turn on the walking monitor to monitor the amount of the time you use your device while walking.
- **Volume monitor:** Turn on the volume monitor to protect your hearing.
- **Parental controls:** Manage your children's digital use.

Device care

The device care feature provides an overview of the status of your device's battery, storage, memory, and system security. You can also optimise the device.

On the Settings screen, tap **Device care**.

- **Optimise now:** Close apps running in the background or using an abnormal amount of battery and scan for crashed apps and malware to optimise your device.
- **Battery:** Check the remaining battery power and time to use the device. For devices with low battery levels, conserve battery power by turning on power saving features. Refer to [Battery](#) for more information.

- **Storage:** Check the status of used and available storage and free up storage by deleting unnecessary files, such as the files in the recycle bin, unused files, or duplicated files after checking them.
 -  • The actual available capacity of the internal storage is less than the specified capacity because the operating system and default apps occupy part of the storage. The available capacity may change when you update the device.
 - You can check the available capacity of the internal storage in the Specification section for your device on the Samsung website.
- **Memory:** Check memory usage or tap **Clean now** to free up memory by stopping background apps.
- **App protection:** Scan your device for malware and other suspicious activity to stay safe.
- **Performance profile:** Change the performance profile in consideration of the device's processing speed, battery life, and cooling efficiency.
- **Auto optimisation:** Perform auto optimisation by closing background apps or cleaning up memory, to keep the device running in its best condition.

Tap **Auto restart** to set the device to restart automatically when performance issues are detected or at a time you set.
- **Software update:** Update your device's software through the firmware over-the-air (FOTA) service. You can also schedule software updates.
- **Diagnostics:** Test your device using Samsung Members.
- **Maintenance mode:** Turn on maintenance mode to protect your privacy while someone else is using your device, such as when you send it for repairs.

Apps

Manage the device's apps and change their settings. You can check the apps' usage information, change their notification or permission settings, or uninstall or disable unnecessary apps.

On the Settings screen, tap **Apps**.

General management

Customise your device's system settings or reset the device.

On the Settings screen, tap **General management**.

- **Language:** Select device languages. Refer to [Adding device languages](#) for more information.
- **App languages:** Select the language you want to use for each app.
- **Language packs:** Manage or download language packs for voice input, the text-to-speech feature, and translation.
- **Date and time:** Access and alter the settings to control how the device displays the time and date.
 -  If the battery remains fully discharged, the time and date is reset.
- **Samsung Keyboard settings:** Change the settings for the Samsung Keyboard.
- **Keyboard list and default:** Select a keyboard to use by default and change the keyboard settings.
- **Physical keyboard:** Change the settings for an external keyboard.
- **Mouse and trackpad:** Change the settings for an external mouse or trackpad.
- **Reset:** Reset your device's settings or perform a factory data reset.
- **Customisation Service:** Set to get personalised service based on your interests and how you use your device.
- **Contact us:** Ask questions or check the frequently asked questions.

Adding device languages

You can add languages to use on your device.

- 1 On the Settings screen, tap **General management** → **Language** → **Add language**.
- 2 Select a language to add.
- 3 To set the selected language as the default language, tap **Set as default**. To keep the current language setting, tap **Keep current**.
The selected language will be added to your languages list. If you changed the default language, the selected language will be added to the top of the list.

To change the default language from your languages list, select the language you want and tap **Apply**. If an app does not support the default language, the next supported language in the list will be used.

Accessibility

Configure various settings to improve accessibility to the device. Refer to [Accessibility](#) for more information.

On the Settings screen, tap **Accessibility**.

Software update

Update your device's software through the firmware over-the-air (FOTA) service. You can also schedule software updates.

On the Settings screen, tap **Software update**.

- **Download and install:** Check for and install updates manually.
- **Auto download:** Select when to automatically download software updates.
- **Last update:** Check out information about the last software update.

 If emergency software updates are released for your device's security and to block new types of security threats, they will be installed automatically without your agreement.

Security updates information

Security updates are provided to strengthen the security of your device and protect your personal information. For security updates for your model, visit security.samsungmobile.com.

 The website supports only some languages.

About phone

Access your device's information.

On the Settings screen, tap **About phone**.

To change your device's name, tap **Rename**.

- **Status information:** Check out various device information, such as the SIM card status, Wi-Fi MAC address, and serial number.
- **Legal information:** Access legal information related to the device, such as safety information and the open source licence.
- **Software information:** Access the device's software information, such as its operating system version and firmware version.
- **Battery information:** Check out battery information.

 You can check the following battery information here. The available information may vary depending on the region or service provider.

- Date of battery manufacturing
- Date of first use
- Number of full charge/discharge cycles (based on rated capacity)
- Measured state of health

Usage notices



Precautions for using the device

Please read this guide when using the device to ensure safe and proper use.

- Descriptions are based on the device's default settings.
- Some content may differ from your device depending on the region, service provider, model specifications, or device's software.
- The device may require a connection to a Wi-Fi or mobile network when using some apps or features.
- Content (high quality content) that requires high CPU and memory usage will affect the overall performance of the device. Apps related to the content may not work properly depending on the device's specifications and the environment that it is used in.
- Samsung is not liable for performance issues caused by apps supplied by providers other than Samsung.
- Samsung is not liable for performance issues or incompatibilities caused by edited registry settings or modified operating system software. Attempting to customise the operating system may cause the device or apps to work improperly.
- Software, sound sources, wallpapers, images, and other media provided with this device are licensed for limited use. Extracting and using these materials for commercial or other purposes is an infringement of copyright laws. Users are entirely responsible for illegal use of media.
- You may incur additional charges for data services, such as messaging, uploading and downloading, auto-syncing, or using location services depending on your data plan. For large data transfers, it is recommended to use the Wi-Fi feature.
- Default apps that come with the device are subject to updates and may no longer be supported without prior notice.
- Modifying the device's operating system or installing software from unofficial sources may result in device malfunctions and data damage or loss. These actions are violations of your Samsung licence agreement and will void your warranty.

- You can see the screen clearly even in strong outdoor sunlight by automatically adjusting the contrast range based on the surrounding environment. Because of the nature of the product, displaying fixed graphics for extended periods may result in afterimages (screen burn-in) or ghosting.
 - It is recommended not to use fixed graphics on part or all of the screen for extended periods and turn off the screen when not using the device.
 - You can set the screen to turn off automatically when you are not using it. Open **Settings**, tap **Display** → **Screen timeout**, and then select the length of time you want the device to wait before turning off the screen.
 - To set the screen to automatically adjust its brightness based on the surrounding environment, open **Settings**, tap **Display**, and then tap the **Adaptive brightness** switch to turn it on.



- Depending on the region or model, some devices are required to receive approval from the Federal Communications Commission (FCC).

If your device is approved by the FCC, you can check out the FCC ID of the device. To access the FCC ID, open **Settings** and tap **About phone** → **Status information**. If your device does not have an FCC ID, it means that the device has not been authorised for sale in the U.S. or its territories and may only be brought to the U.S. for the owner's personal use.

- The use of ultra-wideband (UWB) transmitters is prohibited when aboard an aeroplane or ship. When you turn on Flight mode, the UWB feature will be turned off. (Galaxy S24 Ultra, Galaxy S24+)
- The use of ultra-wideband (UWB) transmitters is prohibited when turned on within a nominated distance of a specified Australian radio astronomy site. (Check the Radio communications Class Licence 2015 published by the Australian Communications and Media Authority for further details). (Galaxy S24 Ultra, Galaxy S24+)
- Depending on the region, you can check out the regulatory information on the device. To access the information, open **Settings** and tap **About phone** → **Regulatory information**.
- The bandwidths supported by the device may vary depending on the region or carrier.
- 5G network availability may vary depending on the model, country, network provider, and user environment.

- Your device contains magnets. Keep it away from credit cards, implanted medical devices, and other devices that may be affected by magnets. In the case of medical devices, keep your device more than 15 cm apart. Stop using your device if you suspect any interference with your medical device and consult your physician or your medical device manufacturer.
- The term 'User guide' in this guide is written as 'User manual' in the quick start guide, depending on the model.

Instructional icons

-  **Warning:** situations that could cause injury to yourself or others
-  **Caution:** situations that could cause damage to your device or other equipment
-  **Notice:** notes, usage tips, or additional information

Notes on package contents and accessories

Refer to the quick start guide for package contents.

- The items supplied with the device and any available accessories may vary depending on the region or carrier.
- The supplied items are designed only for this device and may not be compatible with other devices.
- Appearances and specifications are subject to change without prior notice.
- You can purchase additional accessories from your local Samsung retailer. Make sure they are compatible with the device before purchase.
- Use of Samsung-approved accessories is recommended. Using unapproved accessories may result in performance issues or malfunctions, which may not be covered by warranty.
- Availability of all accessories is subject to change depending entirely on manufacturing companies. For more information about available accessories, refer to the Samsung website.
- Headphones (USB Type-C) that support digital output can be used with the device. However, the device may not be compatible with headphones that use a different audio output method or were made by a different manufacturer.
- The included USB cable supports up to 3A charging. Charger not included. For optimal charging performance, use of an official Samsung 45W charger and a compatible USB cable, sold separately, is recommended. (Galaxy S24 Ultra, Galaxy S24+)
- The included USB cable supports up to 3A charging. Charger not included. (Galaxy S24)
- For environmental reasons, this package does not include a charger. This device can be powered with most USB power adapters and a cable with a USB Type-C plug.
 The charger may be supplied with the device depending on the region.

Maintaining water and dust resistance

Your device is water- and dust-resistant and meets the following international standards.

- IP68 water resistance rating certification: According to the requirements of the IEC 60529 standard, it was tested in 15-35 °C, 86-106 kPa, 1.5 m fresh water for 30 minutes without moving.

You must follow the guidelines to maintain the water- and dust-resistance of your device.

- Do not expose the device to swimming pool water or sea water.
- If the device is exposed to unclean water or other liquids, such as soapy water, oil, perfume, sunscreen, hand cleaner, chemical products such as cosmetics, or liquids that include the alcohol, clean the device with fresh water that does not flow, wipe it with a soft and clean cloth, and then dry it thoroughly before use to maintain the water resistance.
- Do not expose the device to water moving with force. A sudden rise in the water pressure may exceed the guaranteed level of water resistance.
- In places, such as a sauna or steam room, the water-resistant performance may be damaged because of sudden changes in the temperature.
- If the device is subjected to an external shock or is damaged, its water resistance may decrease.

If the device is exposed to water or pollutants, follow the guidelines:

- Wipe the device with a soft and clean cloth, and then dry it thoroughly.
- If the microphone or speaker is not completely dry, it may result in the sound not being clear during a call.
- The screen and other features may not work properly if the device is used in water.
- Do not connect the charger or any accessories until the device is completely dry. The device can be damaged if an accessory or charger is connected when the multipurpose jack is not yet dry.

The water and dust resistance of your Samsung Galaxy device is not permanent and may diminish over time because of normal wear and tear.

Device overheating situations and solutions

When the device heats up while charging the battery

While charging, the device and the charger may become hot. During wireless charging or fast charging, the device may feel hotter to the touch. This does not affect the device's lifespan or performance and is in the device's normal range of operation. If the battery becomes too hot, the charging speed may decrease or the charger may stop charging.

Do the following when the device heats up:

- Disconnect the charger from the device and close any running apps. Wait for the device to cool down and then begin charging the device again.
- If the lower part of the device overheats, it may be because of a damaged USB cable. Replace the USB cable with a new one. A Samsung-approved USB cable is recommended.
- When using a wireless charger, do not place foreign materials, such as metal objects, magnets, and magnetic stripe cards, between the device and the wireless charger.

 The wireless charging or fast charging feature is only available on supported models.

When the device heats up during use

When you use features or apps that require more power or use them for extended periods, your device may temporarily heat up because of increased battery consumption. Close any running apps and do not use the device for a while.

Refer to the following examples of situations in which the device may overheat.

- During the initial setup after purchase or when restoring data
- When downloading large files

- When using apps that require more power or using apps for extended periods
 - When playing high-quality games for extended periods
 - When recording videos for extended periods
 - When streaming videos while using the maximum brightness setting
 - When connecting to a TV
- While multitasking (or, when running many apps in the background)
 - When using Multi window
 - When updating or installing apps while recording videos
 - When downloading large files during a video call
 - When recording videos while using a navigation app
- When using large amount of data for syncing with the cloud, email, or other accounts
- When using a navigation app in a car while the device is placed in direct sunlight
- When using the Mobile Hotspot and Tethering feature
- When using the device in areas with weak signals or no reception
- When charging the battery with a damaged USB cable
- When the device's multipurpose jack is damaged or exposed to foreign materials, such as liquid, dust, metal powder, and pencil lead
- When you are roaming

Do the following when the device heats up:

- Keep the device updated with the latest software.
- Conflicts between running apps may cause the device to heat up. Restart the device.
- Turn off the Wi-Fi, GPS, and Bluetooth features when not using them.
- Close apps that increase battery consumption or that run in the background when not in use.
- Delete unnecessary files or unused apps.
- Decrease the screen brightness.
- If the device overheats or feels hot for a prolonged period, do not use it for a while. If the device continues to overheat, contact a Samsung Service Centre or an authorised service centre.

Precautions for device overheating

If you begin to feel uncomfortable because of the device overheating, stop using the device.

When the device heats up, the features and performance may be limited or the device may turn off to cool down. The feature is only available on supported models.

- If the device overheats, the screen brightness, the screen refresh rate, and the performance speed will be limited to lower the device's temperature. Even if the battery charging indicator icon appears, charging may be slow. When charging stops because of a rise in the device's temperature, the battery indicator icon will blink.
- If the device reaches a certain temperature, a warning message will appear to prevent device failure, skin irritation and damage, and battery leakage. Running apps will be closed and all calling and other features will be limited, except for emergency calls, until the device cools down.
- If the second message appears because of a further increase of the device's temperature, the device will turn off. Do not use the device until the device's temperature is within the recommended operating temperature range. If the second warning message appears during an emergency call, the call will not be disconnected by a forced termination.

Recommended operating temperature range

The device's recommended operating temperature is between 0 °C to 35 °C. Using the device outside of the recommended temperature range may damage the device or reduce the battery's lifespan.

Precautions for operating environment

Your device may heat up because of the environment in the following conditions. Use caution to avoid shortening the battery's lifespan, damaging the device, or causing a fire.

- Do not store your device in very cold or very hot temperatures.
- Do not expose your device to direct sunlight for extended periods.
- Do not use or store your device for extended periods in very hot areas, such as inside a car in the summertime.
- Do not place the device in any areas that may overheat, such as on an electric heating mat.
- Do not store your device near or in heaters, microwaves, hot cooking equipment, or high pressure containers.
- Do not use a cable whose covering is peeled off or damaged, and do not use any charger or battery that is damaged or malfunctioning.

How to find the standby power consumption information for this product

- Access www.samsung.com/global/ecodesign_energy.
- Search using the product model number.

 This feature may not be available depending on the region, carrier, or model.

Appendix



Accessibility

About Accessibility

Improve accessibility with features that make the device easier to use for users who have impaired vision, hearing, and reduced dexterity.

Open **Settings** and tap **Accessibility**. To check recommended features and the accessibility features you are using, tap **Recommended for you**. To turn off the features in use, tap **Turn off**.

Vision enhancements

Display mode

Change the display mode.

Open **Settings**, tap **Accessibility** → **Vision enhancements**, and then select a mode you want under **Display mode**.

Using the high contrast theme

Apply a clear theme that displays light-coloured content on a dark background.

Open **Settings**, tap **Accessibility** → **Vision enhancements** → **High contrast theme**, and then select a theme you want.

Using the high contrast font

Adjust the colour and outline of fonts to increase the contrast between the text and the background.

Open **Settings**, tap **Accessibility** → **Vision enhancements**, and then tap the **High contrast fonts** switch to turn it on.

Using the high contrast keyboard

Change the colours of the Samsung Keyboard to increase the contrast between the text and the background.

Open **Settings**, tap **Accessibility** → **Vision enhancements**, and then tap the **High contrast keyboard** switch to turn it on.

Displaying button shapes

Display button shapes with frames to make them stand out.

Open **Settings**, tap **Accessibility** → **Vision enhancements**, and then tap the **Highlight buttons** switch to turn it on.

Making outlines clearer

Display objects in images and videos more clearly with strong outlines.

Open **Settings**, tap **Accessibility** → **Vision enhancements** → **Relumino outline**, and then tap the switch to turn it on.

To adjust the outline thickness, drag the adjustment bar under **Outline thickness**.

Reversing the display colours

Improve screen visibility to help users recognise text on the screen.

Open **Settings**, tap **Accessibility** → **Vision enhancements**, and then tap the **Colour inversion** switch to turn it on.

Colour correction

Adjust how colours are displayed on the screen if you have difficulty in distinguishing colours. The device changes the colours into more recognisable colours.

Open **Settings**, tap **Accessibility** → **Vision enhancements** → **Colour correction**, and then tap the switch to turn it on. Select an option.

Colour filter

Adjust the screen colours if you have difficulty in reading the text.

Open **Settings**, tap **Accessibility** → **Vision enhancements** → **Colour filter**, and then tap the switch to turn it on. Select a colour you want.

To adjust the transparency level, drag the adjustment bar under **Opacity**.

Reducing screen motion effects

Reduce animation effects if you are sensitive to animations or screen movement.

Open **Settings**, tap **Accessibility** → **Vision enhancements**, and then tap the **Reduce animations** switch to turn it on.

Reducing transparency and blur effects

Reduce the transparency and blur effects to make the content on the screen more visible.

Open **Settings**, tap **Accessibility** → **Vision enhancements**, and then tap the **Reduce transparency and blur** switch to turn it on.

Dimming the screen

Dim the screen below the minimum brightness setting for a more comfortable viewing experience.

Open **Settings**, tap **Accessibility** → **Vision enhancements**, and then tap the **Extra dim** switch to turn it on.

Magnifying the screen

Magnify the screen and zoom in on a specific area.

Open **Settings**, tap **Accessibility** → **Vision enhancements** → **Magnification** → **Magnification shortcut**, and then tap the switch to turn it on. Then tick the actions to use to start using this feature directly.

- **Tap Accessibility button:** Zoom in by tapping the Accessibility icon (♿) on the navigation bar.
- **Press Side and Volume up buttons:** Zoom in by pressing the Side button and the Volume Up button simultaneously.
- **Press and hold Volume up and down buttons for 3 seconds:** Zoom in by pressing and holding the Volume Up button and the Volume Down button simultaneously for 3 seconds.
- **Triple-tap screen:** Zoom in by tapping the screen three times.

You can magnify wherever you want on the screen using the magnifier window. To move the magnifier, drag the edge of the magnifier frame.

To explore the screen, drag two fingers across the magnified screen.

To adjust zoom ratio, pinch two fingers on the magnified screen or spread them apart.



- When you magnify the entire screen, the keyboards and navigation bar on the screen cannot be magnified.
- When this feature is turned on, the performance of some apps may be affected.

Using the magnifier

Use the camera as a magnifying glass to magnify objects.

Open **Settings**, tap **Accessibility** → **Vision enhancements** → **Magnifier** → **Magnifier shortcut**, and then tap the switch to turn it on. Then tick the actions to use to start using this feature directly. When you perform the action, the camera will work like a magnifying glass.

Changing the cursor thickness

Open **Settings** and tap **Accessibility** → **Vision enhancements** → **Cursor thickness**.

Changing the size and colour of the pointer

Enlarge the pointer when using an external mouse or touchpad. You can also change the colour of the pointer.

Open **Settings** and tap **Accessibility** → **Vision enhancements** → **Pointer size and colour**.

Changing font

Change the font size and style.

Open **Settings** and tap **Accessibility** → **Vision enhancements** → **Font size and style**.

Changing screen zoom

Make the items on the screen larger or smaller.

Open **Settings** and tap **Accessibility** → **Vision enhancements** → **Screen zoom**.

Speak keyboard input aloud

Set the device to read aloud what you enter on the keyboard.

Open **Settings**, tap **Accessibility** → **Vision enhancements** → **Speak keyboard input aloud**, tap the switch to turn it on, and then select an option.

Using audio description

Set the device to play the audio description when playing a video that provides audio descriptions.

Open **Settings**, tap **Accessibility** → **Vision enhancements**, and then tap the **Audio description** switch to turn it on.

Bixby Vision for accessibility

Bixby Vision is a service that provides various features based on image recognition. Refer to [Bixby Vision](#) for more information.

Adding voice recordings to voice labels

You can use voice labels to distinguish objects of similar shape by attaching labels to them. You can record and assign a voice recording to an NFC-enabled voice label. The voice recording is played back when you place your device near the label.

 Turn on the NFC feature before using this feature.

- 1 Open **Settings** and tap **Accessibility** → **Vision enhancements** → **Voice Label**.
The voice recorder will open.
- 2 Tap the Record icon () to start recording. Speak into the microphone.
- 3 When you are finished recording, tap **Done** to stop.
- 4 Hold the back of your device over the voice label.
The information in the voice recording will be written to the voice label.

TalkBack (Voice feedback)

Turning TalkBack on or off

When you turn on TalkBack, the device will start voice feedback. When you tap the selected feature once, the device will read the text on the screen aloud. Tapping the feature twice will turn on the feature.

Open **Settings**, tap **Accessibility** → **TalkBack**, and then tap the switch to turn it on.

To turn off TalkBack, tap the switch and double tap anywhere on the screen.

To check out how to use TalkBack, tap **Settings** → **TalkBack tutorial**.

 Some features are not available while you are using TalkBack.

Controlling the screen with finger gestures

You can use various finger gestures to control the screen while you are using TalkBack.

To check out and customise available finger gestures, open **Settings** and tap **Accessibility** → **TalkBack** → **Settings** → **Customise gestures**.

Using the reading menu

While you are using TalkBack, swipe to the left or right with three fingers. The reading menu will appear and the device will read the options aloud. Swipe to the left or right with three fingers to scroll through the options. When you hear the option you want, swipe upwards or downwards to use the option or adjust the settings for the option. For example, when you hear **Speech rate**, you can adjust the speech rate by swiping upwards or downwards.

Adding and managing image labels

You can assign labels to images on the screen. The device reads aloud the labels when the images are selected. Add labels to unlabelled images by swiping upwards or downwards, then to the right. Then, tap **Add label** when the TalkBack menus appear.

To manage the labels, open **Settings** and tap **Accessibility** → **TalkBack** → **Settings** → **Advanced settings** → **Custom labels**.

Configuring settings for TalkBack

Configure settings for TalkBack for your convenience.

Open **Settings** and tap **Accessibility** → **TalkBack** → **Settings**.

- **New features in TalkBack:** Check for key updates and changes to TalkBack.
- **Text-to-speech:** Change the settings for text-to-speech features used when TalkBack is turned on, such as languages, speed, and more.
- **Verbosity:** Customise the detailed settings for voice feedback.
- **Sound and vibration:** Change sound and vibration settings for TalkBack.
- **Customise focus:** Set the device to thicken the border of the focus indicator that appears when you tap items. You can also change the colour of the indicator.
- **Customise gestures:** Check out various finger gestures to control the screen while you are using TalkBack and customise the settings for gestures.
- **Customise menus:** Select which TalkBack menus and reading menus to use.
- **Automatic descriptions:** Configure the automatic description settings. You can hear descriptions when you focus on an unlabelled icon or an image that contains text.
- **Braille keyboard:** Enter letters on the screen using a 6-dot braille keyboard.
- **Braille display:** Connect a braille display and change the settings.

- **Advanced settings:** Configure advanced settings for TalkBack.
- **Open TalkBack in the Galaxy Store:** Open TalkBack from the **Galaxy Store** and check for updates.
- **TalkBack tutorial:** Learn how to use TalkBack.
- **Help:** Visit the TalkBack help webpage.
- **Contact Google Disability Support:** Visit the Google accessibility help webpage.

Entering text using the keyboard

To display the keyboard, tap the text input field and double tap anywhere on the screen.

When you touch the keyboard with your finger, the device reads aloud the character keys under your finger. When you hear the character you want, release your finger from the screen to select it. The character is entered and the device reads the text aloud.

Entering additional characters

Touch and hold a key on the keyboard to enter additional characters available for the key. A pop-up window appears above the key showing available characters. To select a character, drag your finger on the pop-up window until you hear the character you want, and release it.

Hearing enhancements

Live Transcribe

Set the device to capture speech using the device's microphone and convert it to on-screen text.

Open **Settings**, tap **Accessibility** → **Hearing enhancements** → **Live Transcribe** → **Live Transcribe shortcut**, and then tap the switch to turn it on. Tick the actions to use to start using this feature directly. Then, perform the action to transcribe speech.

Live Caption

Set the device to detect speech and automatically generate captions when you play media content, such as videos or podcasts.

Open **Settings**, tap **Accessibility** → **Hearing enhancements** → **Live Caption**, and then tap the **Use Live Caption** switch to turn it on.

Caption settings

Open **Settings**, tap **Accessibility** → **Hearing enhancements** → **Caption preference**, and then tap the **Show captions** switch to turn it on.

Select an option for configuring the caption settings.

Hearing aid support

Set the device to enhance the sound quality to work better with hearing aids.

Open **Settings**, tap **Accessibility** → **Hearing enhancements** → **Hearing aid support**, and then tap the **Hearing aid compatibility** switch to turn it on.

Sound notifications

Set the device to detect sounds, such as the beeping of smoke detectors or crying babies. The device will vibrate when it detects sound and the alert will be saved as a log.

 While this feature is turned on, the voice recognition will not operate.

Open **Settings** and tap **Accessibility** → **Hearing enhancements** → **Sound notifications** → **Open Sound notifications**. Follow the on-screen instructions to turn on the sound notification feature. When sound is detected, the log will be displayed.

Amplify ambient sound

Set the device to amplify the sound around you to help you hear better when using headphones.

- 1 Open **Settings**, tap **Accessibility** → **Hearing enhancements** → **Amplify ambient sound** → **Amplify ambient sound shortcut**, and then tap the switch to turn it on.
- 2 Tick the actions to use to start using this feature directly.
- 3 Connect headphones to the device and wear them.
- 4 Perform the action.

Adapt sound

Optimise the sound setting to find the best sound quality and use it for calls or media playback.

Open **Settings**, tap **Accessibility** → **Hearing enhancements** → **Adapt sound**, tap the switch to turn it on, and then optimise the sound setting.

Turning off all sounds

Set the device to mute all device sounds, such as media sounds, and the caller's voice during a call.

Open **Settings**, tap **Accessibility** → **Hearing enhancements**, and then tap the **Mute all sounds** switch to turn it on.

Mono audio

Mono output combines stereo sound into one signal that is played through all headphone speakers. Use this if you have a hearing impairment or if a single earbud is more convenient.

Open **Settings**, tap **Accessibility** → **Hearing enhancements**, and then tap the **Mono audio** switch to turn it on.

Adjusting the sound balance

Set the device to adjust the sound balance.

- 1 Open **Settings** and tap **Accessibility** → **Hearing enhancements**.
- 2 Drag the adjustment bars under **Left/right sound balance** to the left or right and adjust the sound balance.

Interaction and dexterity

Universal switch

You can control the screen by connecting an external switch or by using head movements and face gestures.

- 1 Open **Settings** and tap **Accessibility** → **Interaction and dexterity** → **Universal switch**.
- 2 Read the on-screen instructions and tap **Done**.

3 Tap the switch to turn it on.

4 If the universal switches are not registered on the device, tap **Add switch** and set switches to control the device.

 To turn on the universal switch feature, at least one switch must be registered on the device.

To set switches to control the device, tap the switch under **Switches**.

To turn off this feature, press the Side button and the Volume Up button simultaneously.

Assistant menu

Displaying the assistive shortcut icon

Set the device to display the assistive shortcut icon for accessing apps, features, and settings. You can control the device by tapping the assistive menus in the icon.

1 Open **Settings** and tap **Accessibility** → **Interaction and dexterity** → **Assistant menu**.

2 Tap the switch to turn it on.

The assistive shortcut icon appears at the bottom right of the screen.

To adjust the assistant shortcut icon's transparency level, drag the adjustment bar under **Transparency**.

Accessing assistive menus

The assistive shortcut icon appears as a floating icon for access to the assistive menus from any screen.

When you tap the assistive shortcut icon, the icon expands slightly and the assistive menus appear on the icon. Tap the left or right arrow, or swipe to the left or right, to select other menus.

Using enhanced assistive menus

Set the device to display enhanced assistive menus for selected apps.

Open **Settings**, tap **Accessibility** → **Interaction and dexterity** → **Assistant menu** → **Select apps to show contextual menus with**, and then tap the switches next to the apps you want to turn on.

Voice Access

Use this feature to control your device by voice.

Open **Settings**, tap **Accessibility** → **Interaction and dexterity** → **Voice Access**, and then tap the switch to turn it on.

Answering or ending calls

Change the method for answering or ending calls.

Open **Settings**, tap **Accessibility** → **Interaction and dexterity** → **Answering and ending calls**, and then tap the switch of the method you want.

Interaction control

Turn on the interaction control mode to restrict the device's reaction to inputs while using apps.

- 1 Open **Settings** and tap **Accessibility** → **Interaction and dexterity** → **Interaction control**.
- 2 Tap the **Interaction control shortcut** switch to turn it on.
- 3 Press the Side button and the Volume Up button simultaneously while using an app.
- 4 Adjust the size of the frame or draw a line around an area that you want to restrict.
- 5 Tap **Done**.
The device displays the restricted area. The restricted area will not react when you touch it and the device's buttons will be blocked. However, you can unblock functions for the Side button, Volume button, and keyboard in interaction control mode.

To turn off the interaction control mode, press the Side button and the Volume Up button simultaneously.

To set the device to lock the screen after turning off the interaction control mode, open **Settings**, tap **Accessibility** → **Interaction and dexterity** → **Interaction control**, and then tap the **Lock screen when deactivated** switch to turn it on.

Touch and hold delay

Set the recognition time for touching and holding the screen.

Open **Settings**, tap **Accessibility** → **Interaction and dexterity** → **Touch and hold delay** → **Set touch and hold delay**, and then select an option.

Tap duration

Set the duration you must touch the screen for the device to recognise it as a tap.

Open **Settings**, tap **Accessibility** → **Interaction and dexterity** → **Tap duration** → **Set tap duration**, and then set the time.

Ignore repeated touches

Set the device to recognise only the first tap within a set time when you tap the screen repeatedly.

Open **Settings**, tap **Accessibility** → **Interaction and dexterity** → **Ignore repeated touches** → **Set time to ignore repeated touches**, and then set the time.

Auto action after pointer stops

Set the device to select an item automatically when you place the mouse pointer over the item. You can also assign actions to use when you move the pointer to a corner of the screen.

Open **Settings**, tap **Accessibility** → **Interaction and dexterity** → **Auto action after pointer stops**, and then tap the **Auto click** switch to turn it on. To assign corner actions, select an option under **Corner actions** and select an action.

Sticky keys

Set an external keyboard's modifier key, such as the Shift, Ctrl, or Alt keys, to stay pressed. This helps you use keyboard shortcuts without pressing two keys at the same time.

Open **Settings**, tap **Accessibility** → **Interaction and dexterity**, and then tap the **Sticky keys** switch to turn it on.

Slow keys

Set the recognition time for pressing a key on the external keyboard.

Open **Settings**, tap **Accessibility** → **Interaction and dexterity** → **Slow keys**, tap the switch to turn it on, and then set the time.

Bounce keys

Set the device to recognise only the first time you press a key within a set time when you press the same key repeatedly.

Open **Settings**, tap **Accessibility** → **Interaction and dexterity** → **Bounce keys**, tap the switch to turn it on, and then set the time.

Advanced settings

Launching accessibility features directly

Set to open the accessibility features directly.

Open **Settings** and tap **Accessibility** → **Advanced settings**. Tap **Accessibility button** → **Select actions**, or select **Quick panel buttons**, **Side and Volume up buttons**, or **Volume up and down buttons**, and then tick the accessibility features you want to use.

Setting light notification

Set the device to blink the flash or the screen when an alarm sounds or when you have notifications, such as incoming calls or new messages.

Open **Settings**, tap **Accessibility** → **Advanced settings** → **Flash notification**, and then tap the switches next to the options you want to turn on.

Time to take action

Set the amount of time to display pop-up windows that ask you to take action, such as notifications or volume controller.

Open **Settings**, tap **Accessibility** → **Advanced settings** → **Time to take action**, and then select an option.

Installed apps

Check out the accessibility services installed on the device.

Open **Settings** and tap **Accessibility** → **Installed apps**.

Troubleshooting

Before contacting a Samsung Service Centre or an authorised service centre, please attempt the following solutions. Some situations may not apply to your device.

You can also use Samsung Members to solve any problems you might encounter while using your device.

When you turn on your device or while you are using the device, it prompts you to enter one of the following codes:

- **Password:** When the device lock feature is turned on, you must enter the password you set for the device.
- **PIN:** When using the device for the first time or when the PIN requirement is turned on, you must enter the PIN supplied with the SIM or USIM card. You can turn off this feature by using the Lock SIM card menu.
- **PUK:** Your SIM or USIM card is blocked, usually as a result of entering your PIN incorrectly several times. You must enter the PUK supplied by your carrier.
- **PIN2:** When you access a menu requiring the PIN2, you must enter the PIN2 supplied with the SIM or USIM card. For more information, contact your carrier.

Your device displays network or service error messages

- When you are in areas with weak signals or poor reception, you may lose reception. Move to another area and try again. While moving, error messages may appear repeatedly.
- Please note that models with the appendix “UD,” if purchased in Germany, cannot receive signals in LTE TDD bands in the following countries: Belgium, Denmark, Germany, France, Luxemburg, Netherlands, Austria, Poland, Switzerland, Czech Republic. If you are in an LTE TDD-only service area, you may lose reception. Move to another area and try again.
- You cannot access some options without a subscription. For more information, contact your carrier.

Your device does not turn on

When the battery is completely discharged, your device will not turn on. Fully charge the battery before turning on the device.

Touch recognition works slowly or improperly

- Touch recognition may not work properly in the following situations:
 - If you attach a screen protector or optional accessories to the screen
 - If you are wearing gloves, if your hands are not clean while touching the screen, or if you tap the screen with a sharp object or your fingertips
 - In humid conditions or when exposed to water
- Restart your device to clear any temporary software problems.
- Ensure that your device software is updated to the latest version.
- If the screen is scratched or damaged, visit a Samsung Service Centre or an authorised service centre.

Your device freezes or encounters a fatal problem

Try the following solutions. If the problem is still not resolved, contact a Samsung Service Centre or an authorised service centre.

Restarting the device

If your device freezes or hangs, you may need to close apps or turn off the device and turn it on again.

Forcing restart

If your device is frozen and unresponsive, press and hold the Side button and the Volume Down button simultaneously for more than 7 seconds to restart it.

Resetting the device

If these methods do not solve your problem, perform a factory data reset.

Open **Settings** and tap **General management** → **Reset** → **Factory data reset** → **Reset** → **Delete all**. Before performing the factory data reset, remember to make backup copies of all important data stored in the device.

Calls are not connected

- Ensure that you have accessed the right cellular network.
- Ensure that you have not set call barring for the phone number you are dialling.
- Ensure that you have not set call barring for the incoming phone number.

Others cannot hear you speaking on a call

- Ensure that you are not covering the built-in microphone.
- Ensure that the microphone is close to your mouth.
- If you are using headphones, ensure that they are properly connected.

Sound echoes during a call

Adjust the volume by pressing the Volume button or move to another area.

A cellular network or the internet is often disconnected or audio quality is poor

- Ensure that you are not blocking the device's internal antenna.
- When you are in areas with weak signals or poor reception, you may lose reception. You may have connectivity problems because of issues with the carrier's base station. Move to another area and try again.
- When using the device while moving, wireless network services may be disabled because of issues with the carrier's network.

The battery does not charge properly (For Samsung-approved chargers)

- Ensure that the charger is connected properly.
- Visit a Samsung Service Centre or an authorised service centre and have the battery replaced. Bring the charger and USB cable you are using for better service support. If wireless charging is not working, bring the wireless charger as well.

The battery depletes faster than when first purchased

- When you expose the device or the battery to very cold or very hot temperatures, the useful charge may be reduced.
- Battery consumption will increase when you use certain features or apps, such as GPS, games, or the internet.
- The battery is consumable and the useful charge will get shorter over time.

Error messages appear when opening the camera

Your device must have sufficient available storage and battery power to operate the camera app. If you receive error messages when opening the camera, try the following:

- Charge the battery.
- Free some storage by transferring files to a computer or deleting files from your device.
- Restart the device.

If you are still having trouble with the camera app after trying these tips, contact a Samsung Service Centre or an authorised service centre.

Picture quality is poorer than the preview

- The quality of your pictures may vary, depending on the surroundings and the photography techniques you use.
- If you take pictures in dark areas, at night, or indoors, image noise may occur or images may be out of focus.

Error messages appear when opening multimedia files

If you receive error messages or multimedia files do not play when you open them on your device, try the following:

- Free some storage by transferring files to a computer or deleting files from your device.
- Ensure that the music file is not Digital Rights Management (DRM)-protected. If the file is DRM-protected, ensure that you have the appropriate licence or key to play the file.

- Ensure that the file formats are supported by the device. If a file format is not supported, such as DivX or AC3, install an app that supports it. To check the file formats that your device supports, visit the Samsung website.
- Your device supports pictures and videos captured with the device. Pictures and videos captured by other devices may not work properly.
- Your device supports multimedia files that are authorised by your carrier or providers of additional services. Some content circulated on the internet, such as ringtones, videos, or wallpapers, may not work properly.

Bluetooth is not working well

If another Bluetooth device is not located or there are connection problems or performance malfunctions, try the following:

- Ensure that the device you wish to connect with is ready to be scanned or connected to.
- Ensure that your phone and the other Bluetooth device are within the maximum Bluetooth range (10 m).
- On your phone, open **Settings**, tap **Connections**, and then tap the **Bluetooth** switch to turn it on again.
- On your phone, open **Settings**, tap **General management** → **Reset** → **Reset Wi-Fi and Bluetooth settings** → **Reset settings** to reset network settings. You may lose registered information when performing the reset.

If these tips do not solve the problem, contact a Samsung Service Centre or an authorised service centre.

A connection is not made when you connect the device to a computer

- Ensure that the USB cable you are using is compatible with your device.
- Ensure that you have the proper driver installed and updated on your computer.

Your device cannot find your current location

GPS signals may be obstructed in some locations, such as indoors. Set the device to use Wi-Fi or a mobile network to find your current location in these situations.

Data stored in the device has been lost

Always make backup copies of all important data stored in the device. Otherwise, you cannot restore data if it is damaged or lost. Samsung is not responsible for the loss of data stored in the device.

A small gap appears around the outside of the device case

- This gap is a necessary manufacturing feature and some minor rocking or vibration of parts may occur.
- Over time, friction between parts may cause this gap to expand slightly.

There is not enough space in the device's storage

Delete unnecessary data, such as cache, using the device care feature or manually delete unused apps or files to free up storage space.

The Home button does not appear

The navigation bar containing the Home button may disappear while using certain apps or features. To access the navigation bar, drag upwards from the bottom of the screen.

Removing the battery

- **To remove the battery, contact an authorised service centre. To obtain battery removal instructions, please visit www.samsung.com/global/ecodesign_energy.**
- For your safety, you **must not attempt to remove** the battery. If the battery is not properly removed, it may lead to damage to the battery and device, cause personal injury, and result in the device being unsafe.
- Samsung does not accept liability for any damage or loss (whether in contract or tort, including negligence) which may arise from failure to precisely follow these warnings and instructions, other than death or personal injury caused by Samsung's negligence.

Copyright

Copyright © 2025 Samsung Electronics Co., Ltd.

This guide is protected under international copyright laws.

No part of this guide may be reproduced, distributed, translated, or transmitted in any form or by any means, electronic or mechanical, including photocopying, recording, or storing in any information storage and retrieval system.

Trademarks

- Samsung and the Samsung logo are registered trademarks of Samsung Electronics Co., Ltd.
- Bluetooth® is a registered trademark of Bluetooth SIG, Inc. worldwide.
- Wi-Fi®, Wi-Fi Direct™, Wi-Fi CERTIFIED™, and the Wi-Fi logo are registered trademarks of the Wi-Fi Alliance.
- Manufactured under license from Dolby Laboratories. Dolby, Dolby Atmos, and the double-D symbol are trademarks of Dolby Laboratories.
- All other trademarks and copyrights are the property of their respective owners.

Ovaj dokument je originalno proizveden i objavljen od strane proizvođača, brenda Samsung, i preuzet je sa njihove zvanične stranice. S obzirom na ovu činjenicu, Tehnoteka ističe da ne preuzima odgovornost za tačnost, celovitost ili pouzdanost informacija, podataka, mišljenja, saveta ili izjava sadržanih u ovom dokumentu.

Napominjemo da Tehnoteka nema ovlašćenje da izvrši bilo kakve izmene ili dopune na ovom dokumentu, stoga nismo odgovorni za eventualne greške, propuste ili netačnosti koje se mogu naći unutar njega. Tehnoteka ne odgovara za štetu nanесenu korisnicima pri upotrebi netačnih podataka. Ukoliko imate dodatna pitanja o proizvodu, ljubazno vas molimo da kontaktirate direktno proizvođača kako biste dobili sve detaljne informacije.

Za najnovije informacije o ceni, dostupnim akcijama i tehničkim karakteristikama proizvoda koji se pominje u ovom dokumentu, molimo posetite našu stranicu klikom na sledeći link:

<https://tehnoteka.rs/p/samsung-galaxy-s24-enterprise-edition-8128gb-onyx-black-akcija-cena/>