

Uputstvo za montažu

PHILIPS OLED televizor 65OLED769/12

PHILIPS

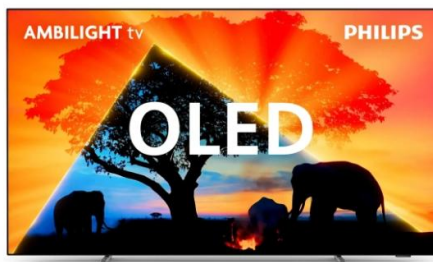

Tehnoteka je online destinacija za upoređivanje cena i karakteristika bele tehnike, potrošačke elektronike i IT uređaja kod trgovinskih lanaca i internet prodavnica u Srbiji. Naša stranica vam omogućava da istražite najnovije informacije, detaljne karakteristike i konkurentne cene proizvoda.

Posetite nas i uživajte u ekskluzivnom iskustvu pametne kupovine klikom na link:

<https://tehnoteka.rs/p/philips-oled-televizor-65oled76912-akcija-cena/>



X41G43SV813B34

Register to find out more and get support
www.philips.com/TVsupport

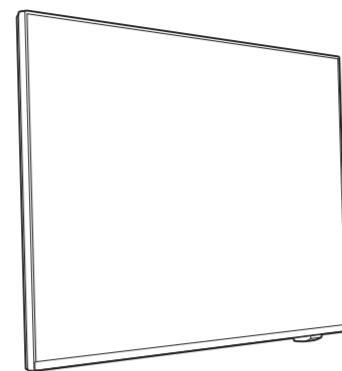
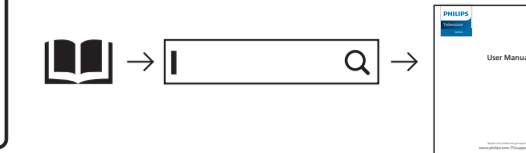

48"/65"

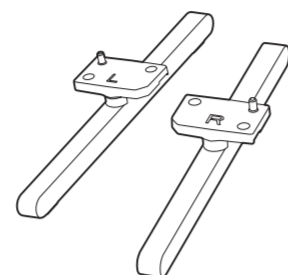

55"

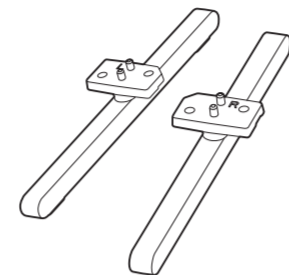

77"

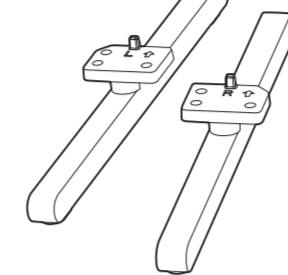

x2

- 48" (M5xL16) : x4
- 55" (M4xL18) : x4
- 65" (M5xL20) : x4
- 77" (M5xL22) : x6
- 55"/65" : x4

(EU)

(77")

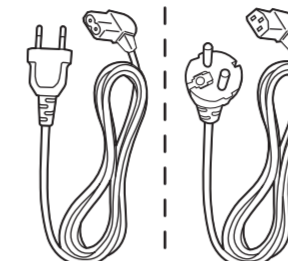

(UK)

(77")

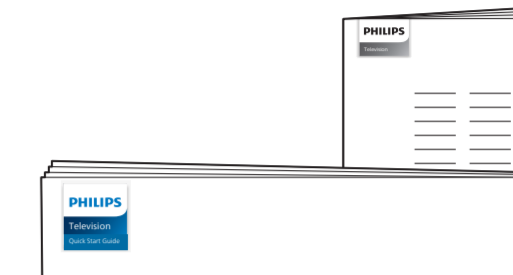
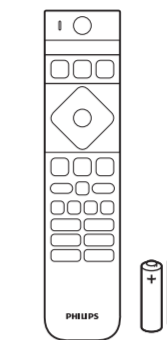
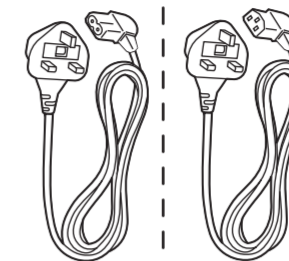

A 48"/55"

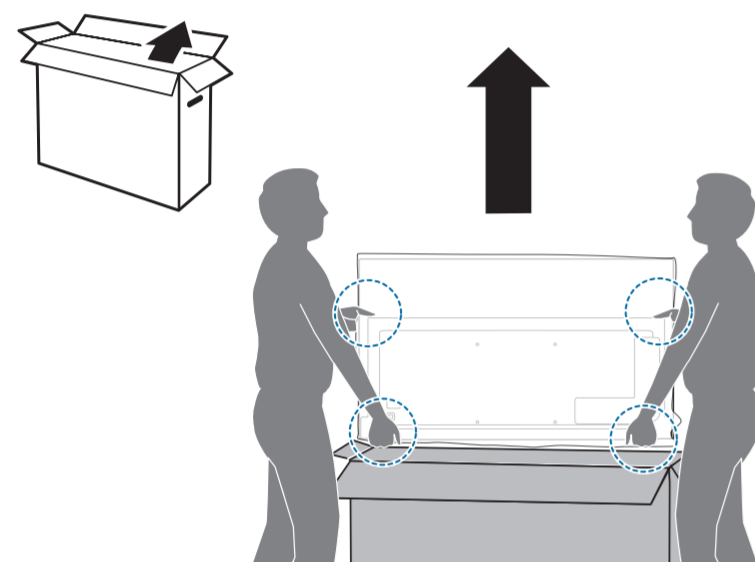

65"/77"

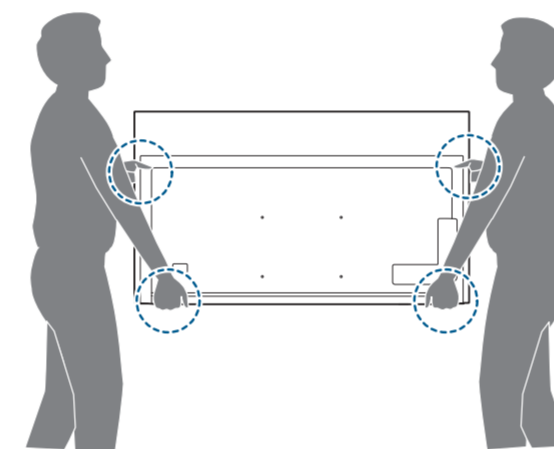
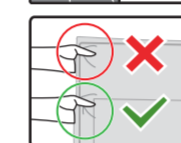
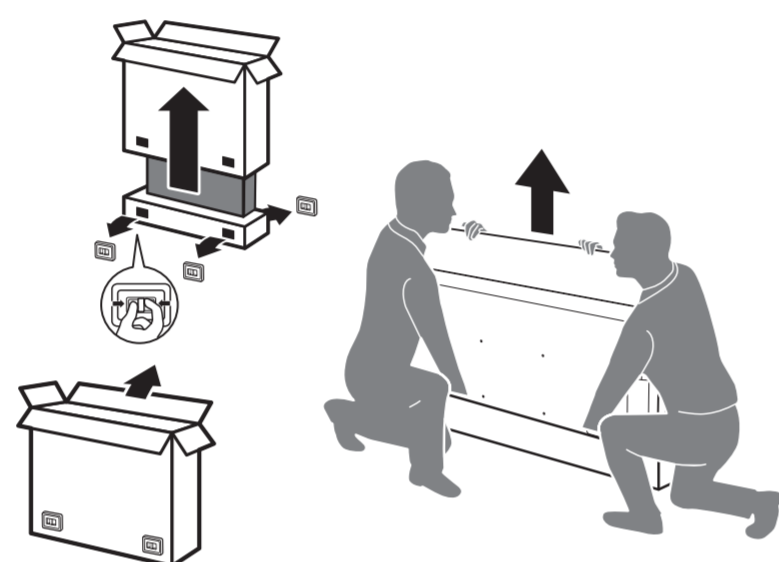

1

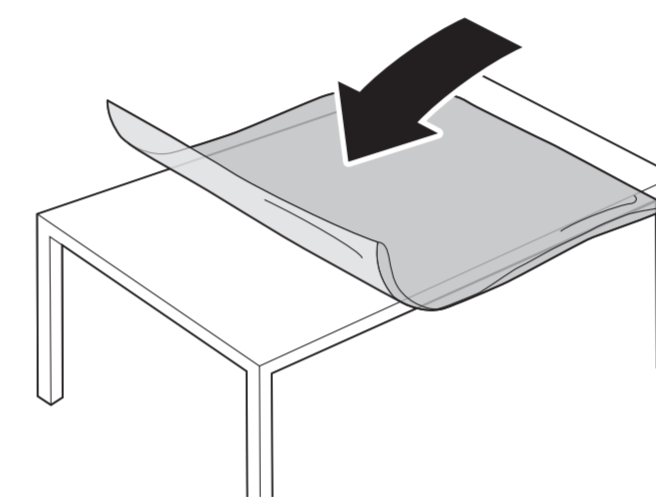

B

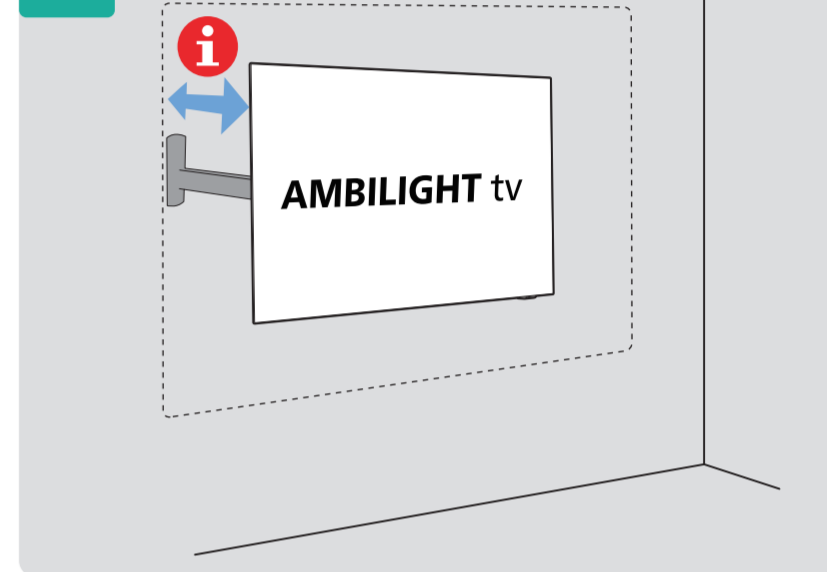

2

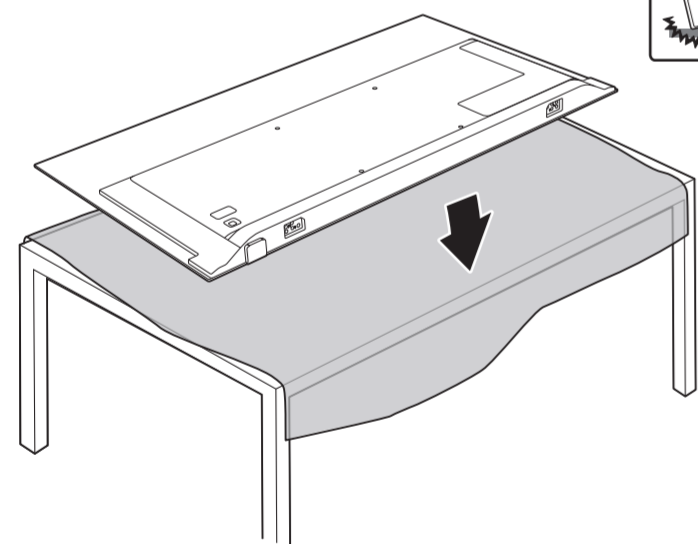

3

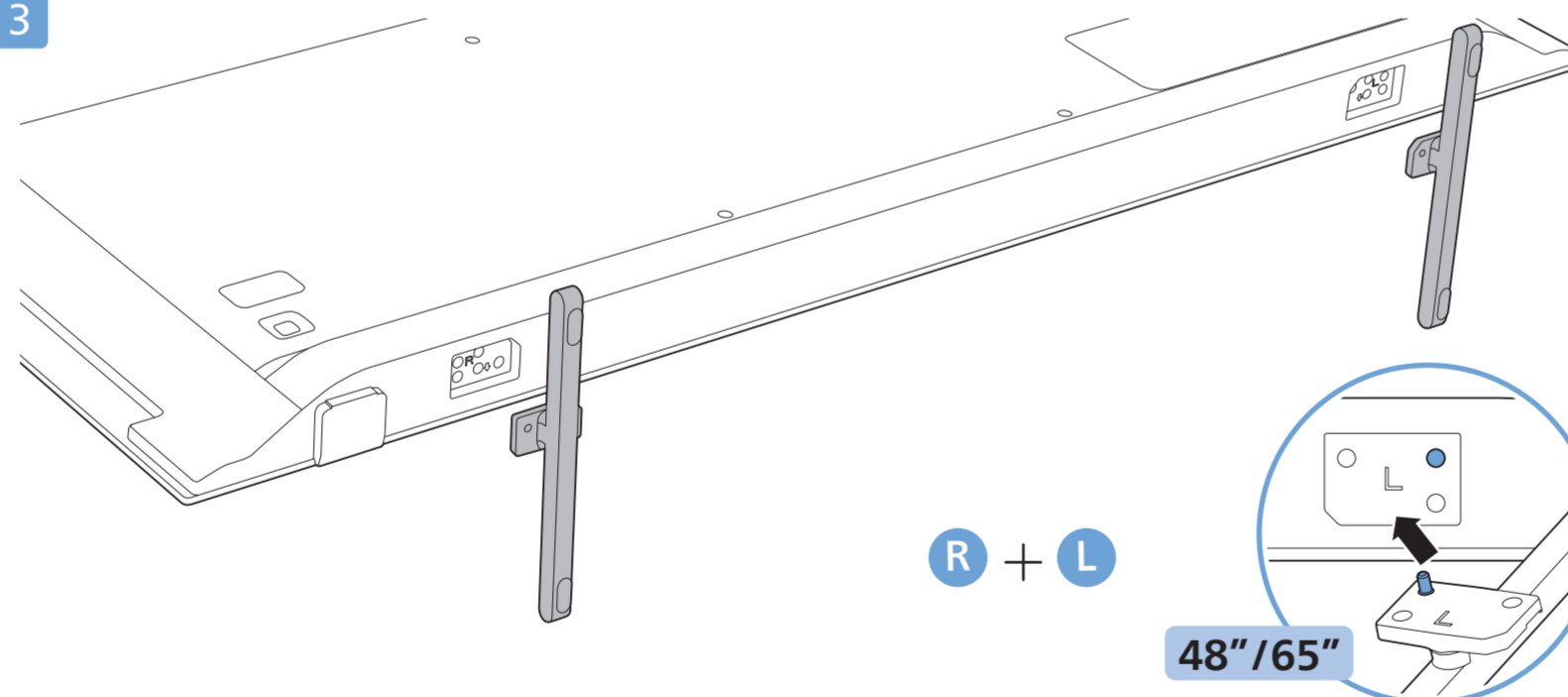

R + L

48"/65"

55"

77"

1

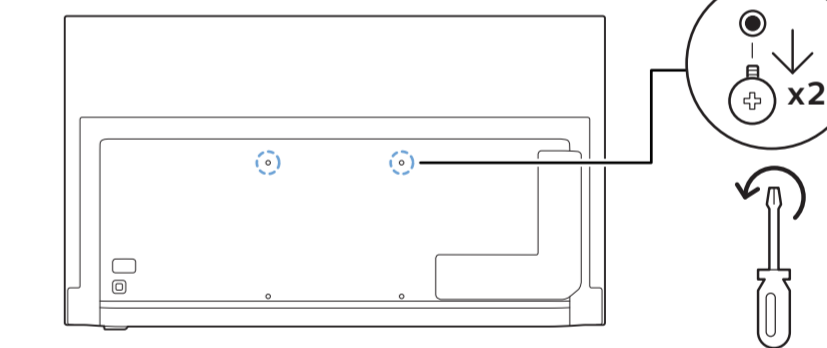

2 Wall Mount dimensions (x, y) Dimensioni del montaggio a parete (x, y)

- 48" 300x300mm M6 (L: 10mm~15mm) 121 cm
- 55" 300x300mm M6 (L: 10mm~15mm) 139 cm
- 65" 300x300mm M6 (L: 10mm~15mm) 164 cm
- 77" 400x300mm M6 (L: 10mm~22mm) 194 cm

4

48"/55"/65"

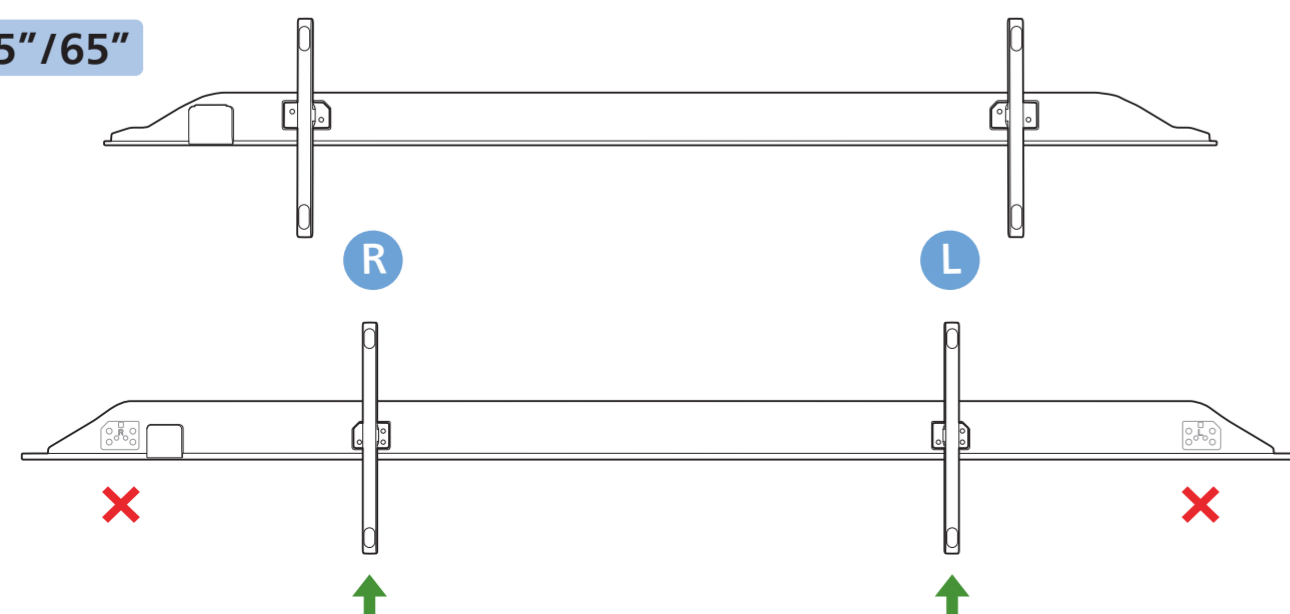

R + L

48"/55"
65"

77"

5

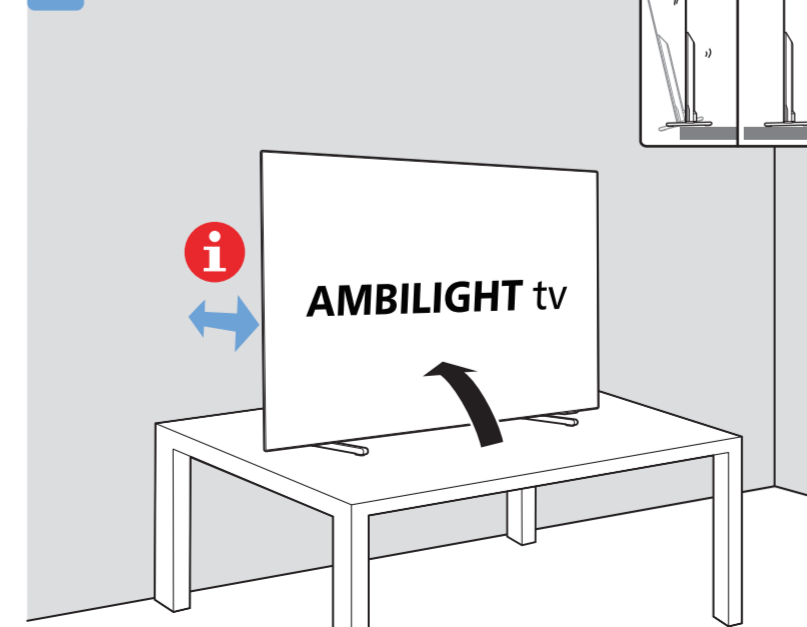

55"/65": x4

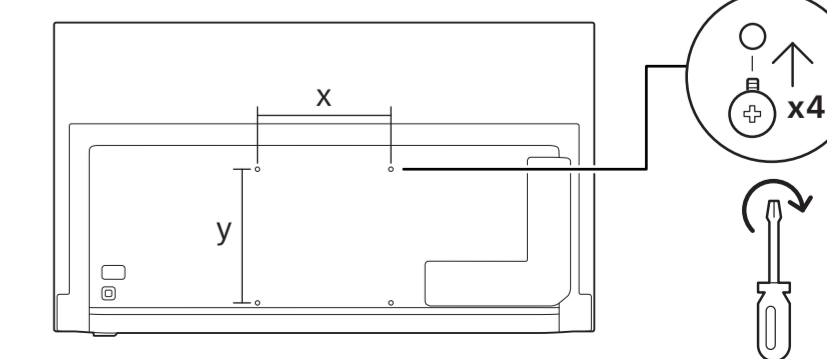

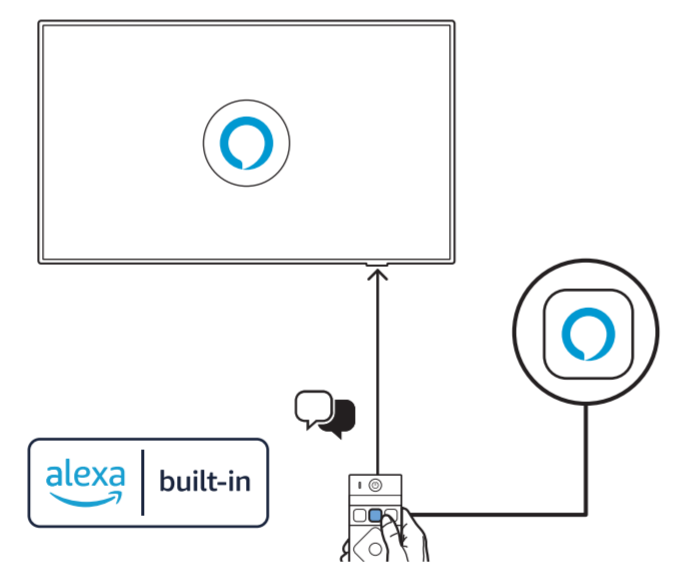
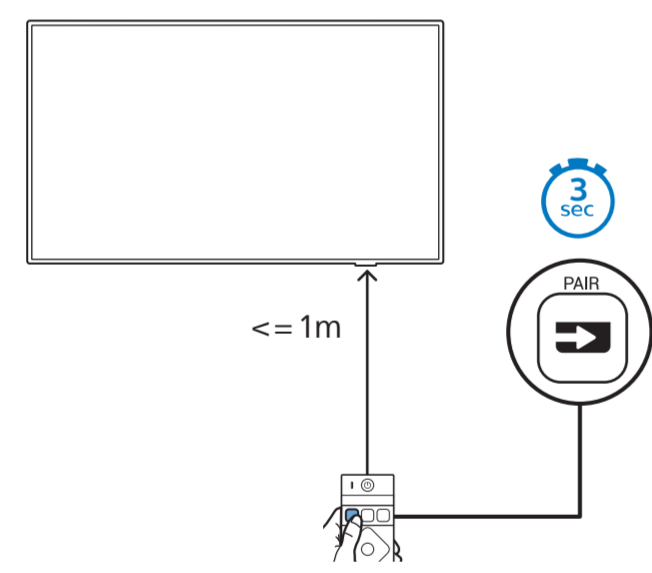
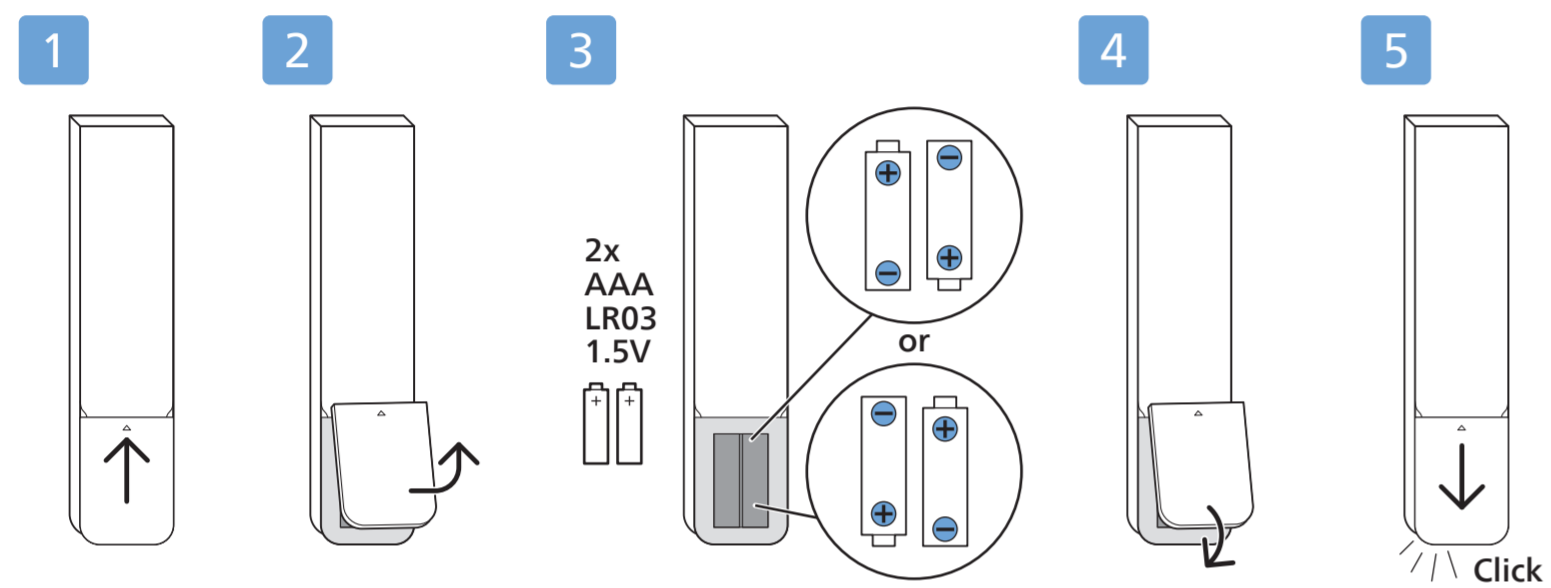
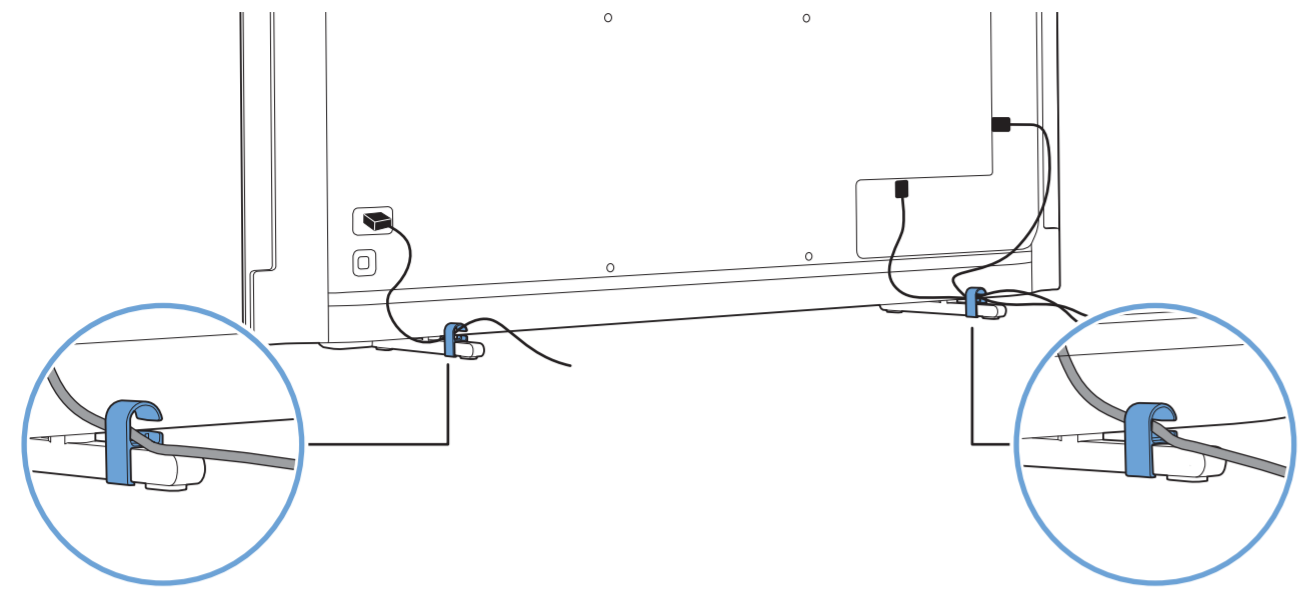

English Read the safety instructions.
Български Прочетете инструкциите за безопасност.
Čeština Přečtěte si bezpečnostní pokyny.
Hrvatski Pročitajte sigurnosne upute.
Dansk Læs sikkerhedsforskrifterne.
Deutsch Lesen Sie die Sicherheitshinweise.
Ελληνικά Διαβάστε τις οδηγίες ασφαλείας.
Eesti Lugege ohutusõudeid.

Español Lea las instrucciones de seguridad.
Français Lisez les consignes de sécurité.
Italiano Leggere le istruzioni di sicurezza.
Қазақша Қорғаныстық нұсқаулар.
Latviešu Izlasiet drošības norādījumus.
Lietuvių Perskaitykite saugos instrukcijas.
Magyar Olvassa el a biztonsági utasításokat.
Nederlands Lees de veiligheidsvoorschriften.
Norsk Les sikkerhetsforskriftene.

Polski Zapoznaj się z instrukcjami bezpieczeństwa.
Português Leia as instruções de segurança.
Română Citiți instrucțiunile de siguranță.
Русский Читайте инструкции по технике безопасности.
Srpski Pročitajte bezbednosna uputstva.
Slovenščina Preberite varnostna navodila.
Slovenský Prečítajte si bezpečnostné pokyny.
Suomi Lue turvaohjeet.

Svenska Läs säkerhetsinstruktionerna.
ภาษาไทย โปรดอ่านคำแนะนำด้านความปลอดภัย
Türkçe Güvenlik talimatlarını okuyun.
Українська Читайте інструкції з техніки безпеки.
العربية قراءة تعليمات السلامة.
עברית קראו את הוראות הבטיחות

FSC Logo H:12mm

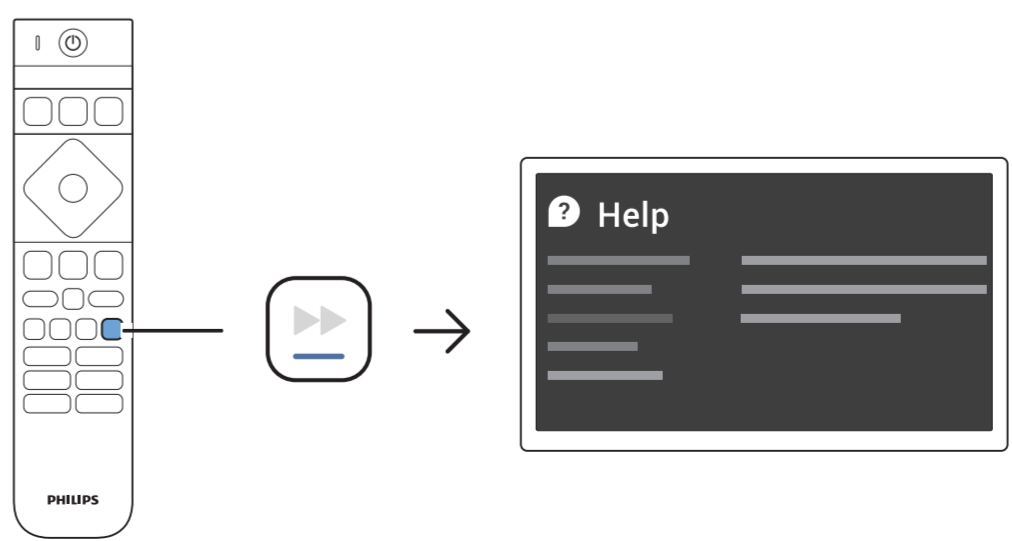
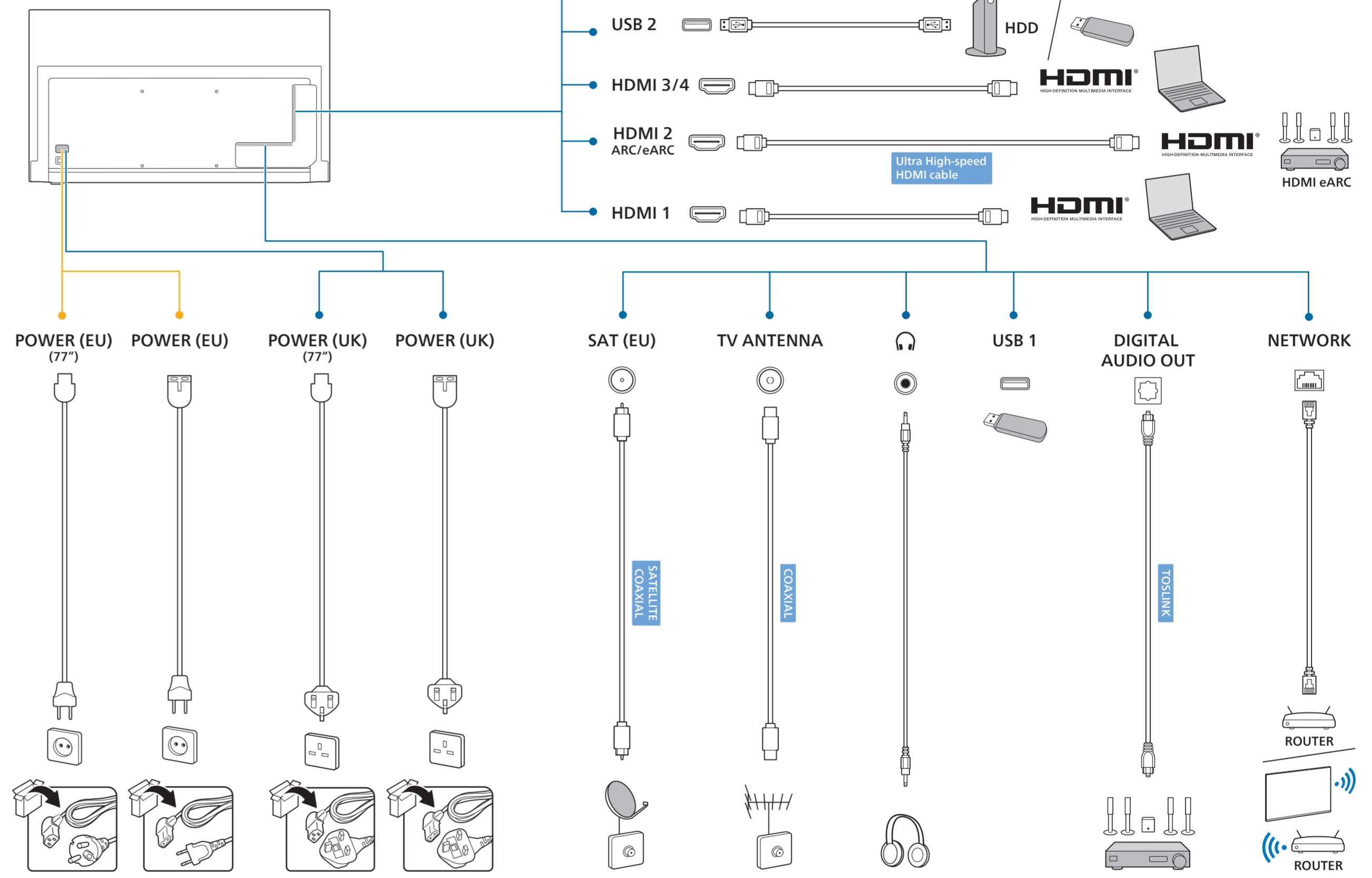
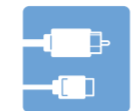

All registered and unregistered trademarks are property of their respective owners. Specifications are subject to change without notice. Philips and the Philips' shield emblem are trademarks of Koninklijke Philips N.V. and are used under license from Koninklijke Philips N.V. This product has been manufactured by and is sold under the responsibility of TP Vision Europe B.V. and TP Vision Europe B.V. is the warrantor in relation to this product. 2024 © TP Vision Europe B.V. All rights reserved. www.philips.com/welcome

Ovaj dokument je originalno proizveden i objavljen od strane proizvođača, brenda Philips, i preuzet je sa njihove zvanične stranice. S obzirom na ovu činjenicu, Tehnoteka ističe da ne preuzima odgovornost za tačnost, celovitost ili pouzdanost informacija, podataka, mišljenja, saveta ili izjava sadržanih u ovom dokumentu.

Napominjemo da Tehnoteka nema ovlašćenje da izvrši bilo kakve izmene ili dopune na ovom dokumentu, stoga nismo odgovorni za eventualne greške, propuste ili netačnosti koje se mogu naći unutar njega. Tehnoteka ne odgovara za štetu nanесenu korisnicima pri upotrebi netačnih podataka. Ukoliko imate dodatna pitanja o proizvodu, ljubazno vas molimo da kontaktirate direktno proizvođača kako biste dobili sve detaljne informacije.

Za najnovije informacije o ceni, dostupnim akcijama i tehničkim karakteristikama proizvoda koji se pominje u ovom dokumentu, molimo posetite našu stranicu klikom na sledeći link:

<https://tehnoteka.rs/p/philips-oled-televizor-65oled76912-akcija-cena/>