

Uputstvo za upotrebu (EN)

FIELDMANN FZF 4008-E električni duvač usisivač lišća



Tehnoteka je online destinacija za upoređivanje cena i karakteristika bele tehnike, potrošačke elektronike i IT uređaja kod trgovinskih lanaca i internet prodavnica u Srbiji. Naša stranica vam omogućava da istražite najnovije informacije, detaljne karakteristike i konkurentne cene proizvoda.

Posetite nas i uživajte u ekskluzivnom iskustvu pametne kupovine klikom na link:

<https://tehnoteka.rs/p/fieldmann-fzf-4008-e-elektricni-duvac-usisivac-lisca-akcija-cena/>



FZF 4008 E

English	3-18
Čeština.....	19-34
Slovenčina	35-50
Magyarul	51-66
Polski	67-82

Electric Garden Vacuum Blower

USER'S MANUAL

Thank you for purchasing this garden vacuum blower. Before using the inverter, please carefully read this user manual and keep it for future reference.

TABLE OF CONTENTS

1. GENERAL SAFETY REGULATIONS	4
Important safety notice	4
Packaging	4
User's manual.....	4
2. MEANINGS OF WARNING SYMBOLS.....	5
3. SAFETY INSTRUCTIONS.....	6
Store these instructions and user's manuals in a safe place.....	6
Work area.....	6
Electrical safety	6
Personal safety	7
Operating and maintaining power tools.....	7
Additional safety directives for garden vacuum blowers	8
Recommendation	9
4. ASSEMBLING THE VACUUM BLOWER	10
Assembly	10
Attaching the collection sack.....	11
Attaching the shoulder strap	11
5. STARTING THE VACUUM BLOWER	12
Before commencing work	12
Starting the vacuum blower	12
Turning off the vacuum blower	12
6. USING THE VACUUM BLOWER.....	13
Using the vacuum blower	13
Operating the vacuum blower	13
7. MAINTENANCE, STORAGE AND REPAIRS.....	14
8. DEVICE DESCRIPTION	15
9. ENVIRONMENTAL PROTECTION	16
10. DISPOSAL	16
11. DECLARATION OF CONFORMITY.....	17

1. GENERAL SAFETY REGULATIONS

Important safety notice

Before putting this power tool into operation it is important that you read the following instructions very carefully and understand them. They have been created for your protection and the protection of others and to ensure the long and problem-free life of this power tool.

- ✿ Carefully unpack the product and take care not to throw away any part of the packaging before you find all the parts of the product.
- ✿ Store the garden vacuum blower in a dry place out of reach of children.
- ✿ Read all warnings and instructions. Failure to comply with the warnings and instructions may lead to electric shock, fire and/or serious injuries.

Packaging

The product's packaging prevents damage during transport. This packaging is a resource and can be recycled.

User's manual











Before you start working with the garden vacuum blower, read the following safety instructions and user's manual. Get familiar with the controls and correct use of the equipment. Keep the user's manual in a safe place for easy future reference. Save the original packaging, including the internal packing material, guarantee card and proof of purchase receipt for at least the time of the guarantee. If you need to ship this machine, pack it in the original cardboard box to ensure maximum protection during shipping or transport (e.g. when moving or when you need to send this product for repair).

 **Note:** If you hand over the appliance to somebody else, do so together with this user's manual. Following the instructions in the included user's manual is a prerequisite for the proper use of the power tool. The user's manual also contains operating, maintenance, and repair instructions.

The manufacturer assumes no responsibility for accidents or damages arising from failure to comply with these instructions.

This power tool is intended exclusively for blowing and vacuuming fallen leaves in private gardens. Any other use that is not explicitly approved in these instructions, may cause damage to the power tool and presents a serious hazard to the user.

2. MEANINGS OF WARNING SYMBOLS

	<p>⚠ WARNING: Carefully read this user's manual. Adhere to important safety instructions</p>
	<p>⚠ WARNING: Always use: Protective footwear Ear protection Eye protection Safety gloves</p>
	<p>Before carrying out any maintenance on this power tool, turn it off and disconnect the power plug from the socket</p>
	<p>In the event that the power cord becomes tangled or damaged, disconnect it from the power socket</p>
	<p>Do not use it when it is raining Do not expose it to the effects of moisture</p>
	<p>Keep other persons at a safe distance Keep all other persons at a safe distance</p>
	<p>When this power tool is connected to a power supply, do not insert hands or feet into openings.</p>
	<p>Double insulation</p>
	<p>⚠ ATTENTION – ENVIRONMENTAL PROTECTION! This power tool must not be disposed of together with household/communal waste. When the power tool comes to the end of its useful life, it must be taken to a collection point for ecological disposal.</p>
	<p>Guaranteed sound power level LWA 106 dB(A)</p>

3. SAFETY INSTRUCTIONS

WARNING

ATTENTION! Read all instructions and manuals, making sure that you understand everything. Not adhering to the following instructions and manuals, may result in electric shock, fire or serious injuries. The term "power tool/s" used in the following text applies to your power tool powered from the mains (connected via the power cord).

Store these instructions and user's manuals in a safe place.

 **Attention:** Noise protection! Adhere to local ordinances when putting it into operation.

Work area

- ✿ Keep the work area clean and ensure sufficient lighting. Untidiness and poor lighting of the work area contribute to the incidence of injuries.
- ✿ Never use power tools in explosive atmospheres such as near flammable liquids, gases or dust. Power tools create sparks, which may ignite dust or fumes.
- ✿ Keep children and bystanders at a safe distance when working with power tools. You may lose control of the power tool when looking around.

Electrical safety

- ✿ The plug of the electrical appliance must fit into the appropriate socket. The power plug must not be modified in any way. Do not use any adapters in connection with the power tool. Unmodified power plugs and suitable power sockets reduce the risk of electric shock.
- ✿ Avoid physical contact with grounded surfaces such as pipes, radiators, kitchen stoves and refrigerators. The risk of electric shock is greater when your body is grounded.
- ✿ Never expose power tools to rain or wet environments. Water that enters into power tools increases the risk of electric shock.
- ✿ Do not use the power cord for any purpose other than its intended use. Never use the power cord for carrying or dragging the power tool and never pull the power plug out of the power socket by pulling on the power cord. Do not subject the power cord to high temperatures, oil, sharp edges or moving parts. Damaged or tangled power cords increase the danger of electric shock.
- ✿ When working with the power tool outdoors, only use extension cords specifically designed for outdoor use. Using extension cords designed for outdoor use limits the risk of electric shock.

Personal safety

- ✿ Always pay full attention and concentrate on your work and proceed prudently when working with power tools. Do not use the power tool if you are tired or under the influence of drugs, alcohol or medication. When working with power tools, a single brief moment of inattentiveness may lead to very serious injuries.
- ✿ Use personal protective equipment. Always use safety glasses. Using personal protective equipment such as dust masks, safety footwear with anti-slip soles, safety helmets or earmuffs (appropriate to the actual work conditions) reduces the risk of injury.
- ✿ Prevent the power tool from being accidentally turned on. Make sure that the On/Off trigger switch is in the "OFF" position before plugging it into a power socket. Carrying power tools with the finger on the ON/OFF trigger switch and plugging turned on power tools into a power socket increases the risk of injuries.
- ✿ Remove all adjustment tools, i.e. screwdrivers before turning on the power tool. A screwdriver or other tool located in the rotating part of the power tool may cause injuries.
- ✿ Do not lean too far forward. Always maintain a stable stance. This will enable better control over the power tool in unexpected situations.
- ✿ Wear appropriate clothing. Do not wear any loose clothing or any decorations. Keep hair, clothing and gloves at a safe distance from moving parts. Loose clothing, decorations or long hair may become caught in the moving parts.
- ✿ If it is possible to mount attachments for suction or dust collection, check that they are properly connected and that they are used correctly. Using these attachments reduces dust related hazards.

Operating and maintaining power tools

- ✿ Do not overload the power tool. Always use suitable power tools for your work tasks. Using suitable power tools will make your work better and safer within the scope of the given performance range.
- ✿ Do not use the power tool if it cannot be turned on and off using the On/Off trigger switch. A power tool that cannot be turned on or off using the intended On/Off trigger switch is dangerous and must be repaired.
- ✿ Always unplug the power plug from the power outlet before carrying out settings, changing a part of the accessories or when putting the power tool out of operation, i.e. storing it. This preventative measure reduces the risk of accidentally starting the power tool.
- ✿ Store an unused power tool out of reach of children and do not permit the power tool to be used by persons that are not acquainted with the power tool and the provided instructions. Power tools are dangerous when used by inexperienced persons.
- ✿ Keep your power tools in good order. Ensure that it is correctly setup and that moving parts are properly attached and generally pay attention to cracked parts and other defects, which could have an effect on the proper operation of the power tool. In the event of defects, have the power tool repaired before using it. Many accidents are caused by poorly maintained power tools.
- ✿ Use the power tool as well as all accessories and respective tools according to the included manuals in the correct manner for the given type of CZ-4 tool; whilst respecting the work conditions and the defined manner of work. Using the power tool for work different to the defined form of work may lead to dangerous situations.
- ✿ Have your power tool repaired only by qualified professional personnel with the exclusive use of original spare parts. This will ensure that the safety of your power tool is maintained.

Additional safety directives for garden vacuum blowers

- ✿ Always use appropriate protective equipment when working with the power tool to prevent injuries to the face, eyes, hands, legs, head or hearing damage. Use safety glasses, i.e. face protection, tall boots, i.e. stable footwear, long pants, work gloves and hearing protection.
- ✿ Never turn the power tool on when it is upside down or when it is not in the correct work position.
- ✿ Turn the motor off and pull out the power plug when not using the power tool, do not leave it without supervision, when cleaning or transporting it, or when the extension cord is tangled or damaged.
- ✿ Never use the power tool when there are other persons in the vicinity, particularly children or pets. Turn the power tool off when children or pets approach. When working with the power tool, maintain a distance of at least 5 metres from other persons or pets.
- ✿ Never point the blowing tube at bystanders or animals. Never blow objects/dirt towards bystanders or animals. The operator of the power tool is responsible for accidents and dangerous situations to which persons or their property are subjected.
- ✿ Never operate the power tool or handle the power plug with wet hands and never use it when it is raining.
- ✿ Use only extension cords specifically designed for outdoor use and that are designated in this manner. Protect the extension cord against high temperatures, oil and sharp edges.
- ✿ The quality of the extension cord must not be lower than type H05RN-F and H05VV-F and must have a minimum conductor cross-section of 1.5 mm² and a maximum recommended length of 30 m.
- ✿ Ensure that the extension cord is secured in such a manner that the plug of the power cord may not disconnect during operation.
- ✿ Keep the air inlets free of dust, fibres, hair and other materials that could reduce air flow.
- ✿ When using the power tool, maintain good balance and a stable stance.
- ✿ Do not use the power tool in enclosed or poorly ventilated areas or in the vicinity of flammable or explosive substances (fluids, gases, dust).
- ✿ Do not use the power tool when you have loose hanging hair or decorations (jewellery). Tie up long hair and put loose hanging decorations aside.
- ✿ Make sure that the vacuum blower does not suck up burning or smouldering materials such as ash, cigarette butts, etc.
- ✿ Never attempt to vacuum broken objects from glass, plastic, porcelain, etc.
- ✿ Do not use the power tool in the suction mode without a collection sack attached.
- ✿ Do not use the vacuum blower on areas covered with coarse or fine gravel neither in the blowing nor suction mode.
- ✿ Only operate the power tool during full daylight or under sufficient artificial lighting.
- ✿ When not using the power tool, place it in a dry place out of children's reach.
- ✿ When finished using it, disconnect the power tool from the power supply and check it for damage. If you have even the slightest doubt about the integrity of your power tool, have it checked at an authorised service centre.
- ✿ Only use the power tool in accordance with the instructions contained in the provided user's manual.
- ✿ Regularly check that all bolts are firmly tightened.
- ✿ Only use spare parts and accessories recommended by the manufacturer.
- ✿ Never attempt to repair the power tool yourself or to reach the parts inside the power tool. If necessary, always take the power tool to an authorised professional workshop.
- ✿ This power tool is not designed to be used by persons (including children) with physical or mental impairments or by persons lacking knowledge and experience, with the exception of the case, where they are under supervision and when they are provided with instructions for the use of the power tool by an adult

responsible for their safety. Children must remain under supervision to ensure that they do not play with the power tool.

- ✿ This power tool is not suitable for use by children.
- ✿ The user should have the vendor or an expert demonstrate the safe operation of the power tool.
- ✿ Statutory regulations may limit the age of the operator.
- ✿ Before every use, check that the extension cords exhibit no signs of damage or ageing. Never a power tool with damaged power cords.
- ✿ Always direct the power cord towards the back, away from the power tool.
- ✿ In the event that the power cord is damaged during operation, pull the power plug out of the socket. Under no circumstances should you touch the power cord.
- ✿ When working on slopes, maintain a stable stance.
- ✿ Pull the power cord plug out of the socket:
 - before leaving the vacuum blower without supervision,
 - before removing any clogged material,
 - before inspecting the power tool, cleaning or performing any kind of work on it.
- ✿ In the event that a foreign object or other waste accidentally enters the vacuum, immediately stop the power tool and only use it after you have checked it and made sure that it is in safe working condition.
- ✿ In the event that the vacuum blower is making unusual sounds or if it starts vibrating abnormally, STOP IT immediately, pull the plug out of the socket and identify the cause. Excessive vibrations may damage the vacuum blower and injure the user

Recommendation

- a) It is recommended that you slightly water dusty surfaces or use a water sprayer.
- b) It is recommended that you use the maximum length of the tube so that the air current reaches the work surface.
- c) It is recommended that you use this power tool at a reasonable time of day, not too early in the morning or too late in the evening as this would disturb your neighbours. Adhere to times stipulated by local ordinances.

User instructions AFTER using the VACUUM

- a) After use, disconnect this power tool from the power source.
- b) Thoroughly clean the power tool according to the instructions contained in chapter 7.

Description of the power tool (fig. 1)



- | | |
|---|--|
| 1. On/Off trigger | 8. Bottom part of the vacuum tube |
| 2. Power cord retainer | 9. Top part of the vacuum tube (vacuuming) |
| 3. Vacuum unit | 10. Top part of the vacuum tube (blowing) |
| 4. Vacuum / blower mode selection lever | 11. Handle |
| 5. Collection sack | 12. Attaching the shoulder strap |
| 6. Attaching the bag to the tube | 13. Power plug |
| 7. Support wheel | |

4. ASSEMBLING THE VACUUM BLOWER

⚠ Warning! This vacuum blower must not be used or turned on until it is fully assembled.
DISCONNECT THE POWER CORD from the power grid before starting the assembly of the vacuum blower.

Assembly

Insert the top parts of the tube (fig 1, point 9, 10) into the vacuum blower unit (fig 1, point 3) and make sure that it is correctly seated. Then secure it in place using the included screws. Then connect the bottom tube with wheels (fig 1, point 8) to the top tubes. Check that it is inserted correctly, pushed in all the way and secured in place using the included screws.

Attaching the collection sack



Before attaching the collection sack, check that the mode selection lever is not clogged by material from previous use.

Place the plastic mouth of the bag over the outlet of the vacuum blower and secure it (fig. 2). Secure the front of the collection sack under the vacuum blower using the collection sack clamp (fig. 3).

Attaching the shoulder strap

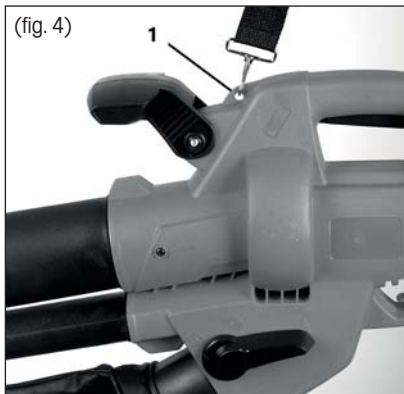

This vacuum blower is supplied with a shoulder strap. This shoulder strap is connected to the top part of the vacuum blower unit using a snap hook (fig. 4, point 1). The shoulder strap reduces fatigue and increases work comfort. The shoulder strap can be set to any position.

5. STARTING THE VACUUM BLOWER

Before commencing work

- ✿ Before using this vacuum blower, connect it to a power source fitted with a residual current device and then turn on this power tool. Check that the residual current device is working correctly.
- ✿ Before starting this vacuum blower, check that the middle tube is secured in place correctly.

⚠ Warning! Before selecting the vacuum or blower function, check that the mode selection lever (Fig 5, point 2) is in the normal position and that it is not blocked by materials from previous use.

Starting the vacuum blower

Using the mode selection lever (fig 5, point 2) located on the side of the vacuum blower unit, select one of the two functions and then turn the power tool on using the On/Off trigger (fig. 5, point 1).

Turning off the vacuum blower

If you want to turn this vacuum blower off, simply release the On/Off trigger (fig. 5, point 1)

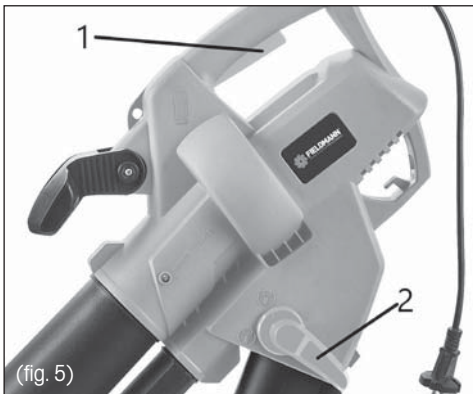

6. USING THE VACUUM BLOWER

Using the vacuum blower

Do not attempt to vacuum wet materials. Before using the vacuum blower, allow fallen leaves and other materials to dry. This vacuum blower can be used to blow materials off terraces, roads, lawns, bushes, edges and pathways. It can also vacuum leaves, paper, small branches and sawdust. When this power tool is used in the vacuum mode, material will be sucked up through the nozzle on the suction tube and then moved to the collection sack. When it passes through the suction fan, it is partially mulched. Mulched plant material is suitable for composting.

⚠ Warning! The suction fan may be damaged in the event that a hard object is sucked in, for example a stone, a can, glass, etc.

⚠ Important Do not use this power tool for vacuuming water or very wet materials. Never use this vacuum blower without the collection sack.

Operating the vacuum blower



Blower mode

Before commencing work, inspect the area that you wish to clean up. Remove all materials and items that could be deflected or which could become stuck or which could block the vacuum blower.

Using the mode selection lever on the side of the power tool (Fig 1, point 5), select the blower function and turn the power tool on. Lean the tube on the wheels and push the power tool forward. Point the tube nozzle at the materials that you wish to remove.

You can also hold the tube nozzle just above the ground and move it from side to side, while proceeding forward in the direction of where you wish to remove material. Blow the material into piles and then use the vacuum function to vacuum up the material.



Vacuum mode

Before commencing work, inspect the area that you wish to clean up. Remove all materials and items that could be deflected or which could become stuck or which could block the vacuum blower. Using the mode selection lever on the side of the power tool (Fig 1, point 5), select the vacuum function and turn the power tool on. Lean the tube on the wheels and push the power tool forward. Point the tube nozzle at the materials that you wish to vacuum. You can also hold the tube nozzle just above the ground and move it from side to side, while proceeding forward in the direction of where you wish to vacuum material. Do not push the tube nozzle directly into the material because this risks clogging the tube and reducing the performance of this power tool.

Plant material such as leaves has a large water content. Therefore, it may stick to the inner walls of the suction tube. If you wish to limit this problem, allow the plant material to dry out for a few days before vacuuming it.

7. MAINTENANCE, STORAGE AND REPAIRS

⚠ Warning! Disconnect this power tool from the power source before cleaning and before carrying out any standard maintenance.

Only store this power tool in a dry place that is protected against light and frost.
Make sure that children do not have access to this power tool.

- a) Keep all nuts and bolts securely tightened to the power tool so as to ensure its correct function.
- b) Never leave material inside the power tool or in the collection sack. This may create a hazard when the vacuum blower is turned on again. Remove and empty out the collection sack. Check the normal function of the mode selection lever and check that it is not clogged with material. Using a suitable brush, clean out the area near the fan and inside the tube of the vacuum blower so that all material is removed. Do not use any type of solvent on the plastic parts of the vacuum blower.
- c) Frequently check the degree of wear and tear on the collection sack.
- d) Replace worn out or damaged parts with original spare parts or accessories. All damaged and worn out parts must be replaced to ensure the good operating condition of the vacuum blower.

Have repairs performed at an authorised service centre that will use only original spare parts.

8. DEVICE DESCRIPTION

Technical specifications	
Input voltage	230–240V
Type of power supply and frequency	50Hz
Input power	3,000W
Protection class:	Class II
Protection against the entry of solid substances and liquids	IPX0
Capacity of the collection sack:	45 l
Air flow speed	240 km/h
Maximum air flow volume	9 m ³
Mulching ratio	1:10
Weight	2.8 kg
Idle speed (rpm)	14,000
Sound pressure level (SPL)	84.3 dB (A)
Sound pressure deviation	kPa = 3 dB
Sound power level (SPL)	106 dB (A)
Sound power deviation LwA	KwA = 3 dB
Total vibration level	3.702 m/s ²
Measurement deviation	K = 1.5 m/s ²

The provided total noise level and vibration values were measured according to the requirements of the testing methodology describe in Directive 2000/14/EC.

9. ENVIRONMENTAL PROTECTION

⚠ Warning! Do not dispose of electrical and electronic waste with standard unsorted waste, rather use containers for sorted waste.

You will receive further information regarding the recycling of this power tool from an authorised vendor or at a waste collection facility.



10. DISPOSAL

INSTRUCTIONS AND INFORMATION ON DISPOSING OF USED PACKAGING MATERIALS

Dispose of used packaging material at a site designated for waste in your municipality.



The appliance and its accessories are manufactured from various materials, e.g. metal and plastic.

Take damaged parts to a recycling centre. Inquire at the relevant government department.



This product meets all the basic requirements of the applicable EU directives.

The text, design and technical specifications may be changed without prior notice and we reserve the right to make these changes.

11. DECLARATION OF CONFORMITY



FAST ČR, a.s.
 U Sanitásu 1621, 251 01 Říčany, Czech Republic
 tel.: +420 323 204 111, fax: +420 323 204 110

EU DECLARATION OF CONFORMITY

Product / brand: Leaf Blower/ Vacuum / **FIELDMANN**

Type / model: **FZF 4008-E** as factory model HY 6306PO
 AC 230 – 240 V, 50Hz, 3000W, Class II, IPX0
 $L_{PA} = 87,3 \text{ dB(A)}$, $L_{WA} = 106 \text{ dB(A)}$

Manufacturer: FAST ČR, a.s.
 U Sanitásu 1621, 251 01 Říčany, Czech Republic
 VAT no: CZ2477749

This declaration of conformity is issued under the sole responsibility of the manufacturer.

The object of the declaration described above is in conformity with the relevant Union harmonization legislation:

Directive MD 2006/42/EC	Directive EMC 2014/30/EU
Directive NEE 2000/14/EC	Directive RoHS 2011/65/EU

The relevant harmonized standards and the other technical specifications:

EN 60335-1:2012+A2	EN 55014-1:2017
EN 50636-2-100:2014	EN 55014-2:2015
EN 62233:2008	EN IEC 61000-3-2:2019
	EN 61000-3-3:2013+A1



Place of issuance: Prague
Date of issuance: 22. 03. 2022

Name: Petr Uher - Responsible Person
Signature:



FAST ČR, a.s.
 U Sanitásu 1621, 251 01 Říčany
 tel.: +420 323 204 111
 IČO: 247 77 749, DIČ: CZ 247 77 749

IČO: 24777749, DIČ: CZ24777749

Bankovní spojení: Komerční banka Praha 1, č.ú. 89309011/0100, ČSOB Praha 1, č.ú. 8010-0116233383/0300
 Česká spořitelna Praha 4, č.ú. 2375682/0800



 **FIELDMANN**[®]
Home & Garden Performance

Ovaj dokument je originalno proizveden i objavljen od strane proizvođača, brenda Fieldmann, i preuzet je sa njihove zvanične stranice. S obzirom na ovu činjenicu, Tehnoteka ističe da ne preuzima odgovornost za tačnost, celovitost ili pouzdanost informacija, podataka, mišljenja, saveta ili izjava sadržanih u ovom dokumentu.

Napominjemo da Tehnoteka nema ovlašćenje da izvrši bilo kakve izmene ili dopune na ovom dokumentu, stoga nismo odgovorni za eventualne greške, propuste ili netačnosti koje se mogu naći unutar njega. Tehnoteka ne odgovara za štetu nanесenu korisnicima pri upotrebi netačnih podataka. Ukoliko imate dodatna pitanja o proizvodu, ljubazno vas molimo da kontaktirate direktno proizvođača kako biste dobili sve detaljne informacije.

Za najnovije informacije o ceni, dostupnim akcijama i tehničkim karakteristikama proizvoda koji se pominje u ovom dokumentu, molimo posetite našu stranicu klikom na sledeći link:

<https://tehnoteka.rs/p/fieldmann-fzf-4008-e-elektricni-duvac-usisivac-lisca-akcija-cena/>