

## Uputstvo za upotrebu (EN)

QCY slušalice H2 PRO crne



Tehnoteka je online destinacija za upoređivanje cena i karakteristika bele tehnike, potrošačke elektronike i IT uređaja kod trgovinskih lanaca i internet prodavnica u Srbiji. Naša stranica vam omogućava da istražite najnovije informacije, detaljne karakteristike i konkurentne cene proizvoda.

Posetite nas i uživajte u ekskluzivnom iskustvu pametne kupovine klikom na link:

<https://tehnoteka.rs/p/qcy-slusalice-h2-pro-crne-akcija-cena/>



# QCY H2 Pro 头戴式无线耳机

## 认识耳机



使用前, 请下载安装QCY手机APP客户端  
以获得更便捷的耳机操控体验



可伸缩支臂  
可折叠挂耳

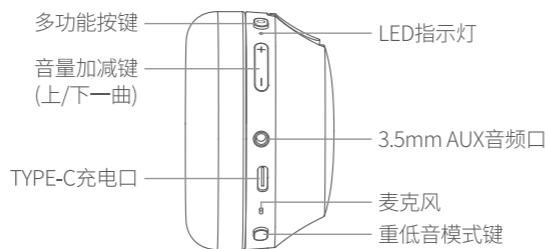

多功能按键  
音量加减键(上/下一曲)  
TYPE-C充电口  
LED指示灯  
3.5mm AUX音频口  
麦克风  
重低音模式键

本说明书中的图片均为示意图, 可能与实物有偏差, 请以实物为准。

## 功能操作

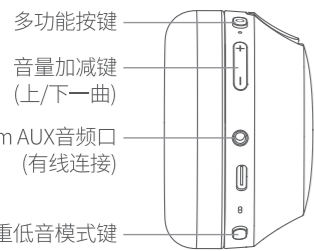

- 🔊 开 机: 长按多功能键2秒
- 🔊 关 机: 长按多功能键4秒
- 📞 接听/挂断: 单击多功能键
- 📞 拒接电话: 长按多功能键1.5秒
- ⏮ 上 一 曲: 长按音量键- 1秒
- ⏭ 下 一 曲: 长按音量键+ 1秒
- ➕ 音 量 加: 单击音量键+
- ➖ 音 量 减: 单击音量键-
- 🗣 语音助手: 双击多功能键
- 🎵 播放/暂停: 单击多功能键
- 🎮 重低音模式: 单击重低音模式按键
- 🎮 游戏模式: 三击多功能键

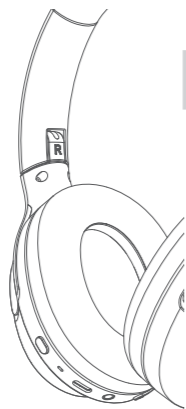

## 售后服务

QCY产品售后服务承诺: 严格按照《中华人民共和国消费者权益保护法》、《中华人民共和国产品质量法》实行售后三包服务, 服务内容如下:  
在三包有效期内, 您可凭购物凭证依照本规定享受免费的修理、更换、退货的权利。

- 自您购买之日起7日内, 本产品出现故障, 经由QCY售后服务中心确定为产品质量问题, 可享受修理、更换、退货的服务。
- 自您购买之日起15日内, 本产品出现故障, 经由QCY售后服务中心确定为产品质量问题, 可享受修理或更换的服务。
- 自您购买之日起12个月内, 本产品出现故障, 经由QCY售后服务中心确定为产品质量问题, 可享受修理的服务。

售后服务与支持  
保修期:  
自产品购买之日起12个月(请妥善保管购买凭证)。  
免费服务:  
在产品保修期内, 凡属产品本身质量问题引起的故障, 请用户凭购买凭证与经销商取得联系以享受售后服务。  
如有任何产品损坏或瑕疵非可归责于产品质量本身, 则不在保修范围内。有下列情形者不属于保修范围内:  
1、因天灾、地震、雷击、异常电压、环境因素而发生之故障或毁损的。  
2、自行或委托未经原厂授权维修之厂商拆卸、改装或更换非原厂零件。  
3、未按使用手册操作或因为使用不当而造成损坏者, 如产品浸水、腐蚀、掉落、挤压或露在异常温湿度环境下。

## 三包凭证

产品信息:  
产品型号 \_\_\_\_\_  
订单编号 \_\_\_\_\_

用户信息:  
用户姓名 \_\_\_\_\_  
联系电话 \_\_\_\_\_  
用户地址 \_\_\_\_\_  
退换货原因 \_\_\_\_\_

购买信息:  
销售单位 \_\_\_\_\_

## 耳机配对

开机后耳机会自动进入配对模式, 打开手机蓝牙搜索“QCY H2 Pro”并点击连接(若有连接记录, 耳机开机自动回连有连接记录的设备。如需重新进入配对模式, 请在关机情况下长按多功能键4秒。)

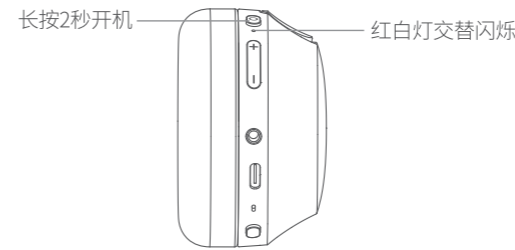

## 同时连接两台设备

A设备已蓝牙连接耳机, 关闭A设备的蓝牙, 耳机进入配对模式, 红蓝灯交替闪烁, 打开B设备的蓝牙, 搜索QCY H2 Pro并连接, 之后再打开A设备的蓝牙并连接耳机。



## 恢复出厂设置

耳机开机状态下同时按住+、-键10秒直至红灯闪烁5次, 耳机进入配对模式, 恢复出厂设置完成。

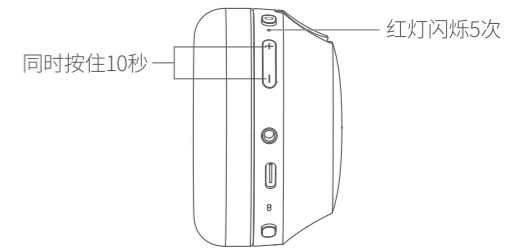

## 亮灯提示

连接状态: 白灯10秒一闪  
充电中: 红灯长亮  
重低音模式: 白灯长亮  
充满电: 白灯长亮

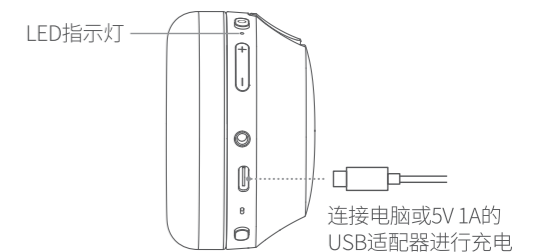

## FAQ

- 1.Q: 手机提示无法连接怎么解决?  
A: 将手机上的配对记录删除, 删除后重新进行搜索配对连接即可。
- 2.Q: 听歌/通话没声音怎么解决?  
A: 先尝试按音量+键, 若无声音, 再进行如下操作:  
安卓手机在蓝牙连接名字的右边有个设置图标, 点击进入, 关闭手机音频和媒体音频, 再重新开启, 若还是无声, 请将耳机重新与手机配对连接。
- 3.Q: 为什么视频/游戏有延迟?  
A: 受使用环境、网络、手机编解码等因素的影响, 会引起手机传送音频数据到耳机时有不同程度的延迟。
- 4.Q: 听到的声音卡顿/断续怎么解决?  
A: 在使用时若周围有大量的 Wi-Fi、5G/4G 信号、大功率电器等等产生干扰, 可能会引起卡顿、断续的情况, 换个环境或者重新配对连接就可以解决了。

## 产品有害物质名称及含量

部件名称	有害物质					
	铅 (pb)	汞 (Hg)	镉 (Cd)	六价铬 (Cr(VI))	多溴联苯 (PBB)	多溴二苯醚 (PBDE)
耳机主体	X	O	O	O	O	O
电 池	O	O	O	O	O	O
配 件	O	O	O	O	O	O
充 电 线	X	O	O	O	O	O

本表格依据SJ/T 11364的规定编制  
O: 表示该有害物质在该部件所有均质材料中的含量均在GB/T 26572规定的限量要求以下。  
X: 表示该有害物质至少在该部件的某一均质材料中的含量超出GB/T 26572规定的限量要求。

## 提示

1. 使用产品前请仔细阅读本使用说明书并请妥善保管;
  2. 首次使用时, 请先将本产品充满电;
  3. 如果产品长期(超过2个星期)不用, 请对其充电;
  4. 必须选择正规厂家生产且经过国家CCC认证的充电器;
  5. 若手机无法搜索到耳机, 请将耳机重新进入配对模式或将耳机恢复出厂设置, 若手机程序出错, 请把手机蓝牙关闭再开启或重启手机。
- 请勿以任何理由拆除或维修改装耳机, 否则可能会导致起火, 电子击穿甚至彻底损坏本品;
  - 请勿将产品置于温度过低或过高(0°C以下或45°C以上的环境下);
  - 请避免靠近儿童或动物的眼睛使用产品指示灯;
  - 请勿在雷暴天气下使用该产品, 雷暴可导致本产品工作不正常, 并增加触电的危险;
  - 请勿用油及其他挥发性液体擦拭本产品;

注意: 长时间使用耳机可能会造成听力损害, 请合理安排使用时间。

使用年限  
如本手册所述, 在正常使用条件下, 本产品的环保使用期限为10年。在此期间, 产品不会泄露任何危险物质, 本产品可以回收, 必须按照当地法规处理。

若有售后服务需求, 请联系客服  
电话: 4008-306-708  
网址: www.qcy.com  
制造商: 东莞市和乐电子有限公司  
地址: 广东省东莞市道滘镇粤晖路325号

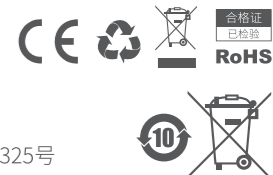



# QCY H2 Pro Wireless Headset

## Overview



For better using experience, please scan to download QCY app before start-up.

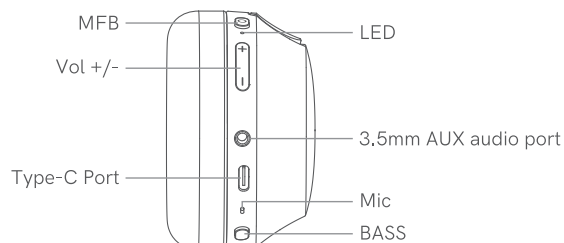
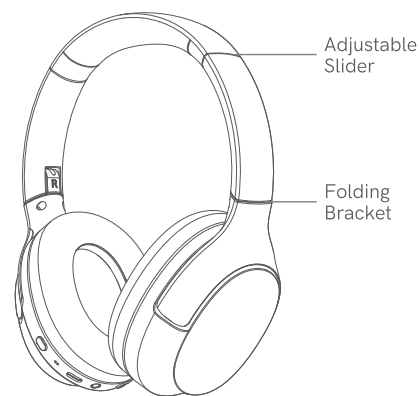

Above pictures are for reference only yet practical product may vary.

## How to Connect

Power on headset and it will auto turn connectable. On phone, search QCY H2 Pro and tap to connect. (It will auto reconnect to the last device in connectivity record, if any. If you need to make it turn connectable again, please power off and hold MFB for 4s.)

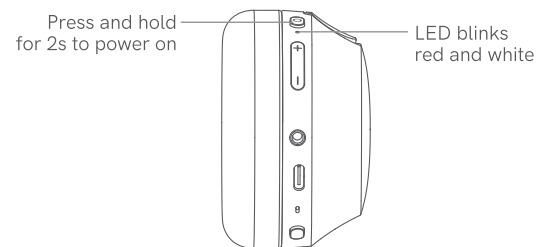

## Multi-Point Connection (Max. 2 Devices)

Connect headset to Device A then turn off its Bluetooth function and the headset will auto turn connectable (LED blinks red and blue). On Device B, search QCY H2 Pro and tap to connect. Once again turn on Bluetooth function on Device A and connect it to the headset.



## Factory Setting

Power on headset, press and hold both volume + and - for 10s or until LED blinks red 5 times to reset it factory. It will then auto turn connectable.

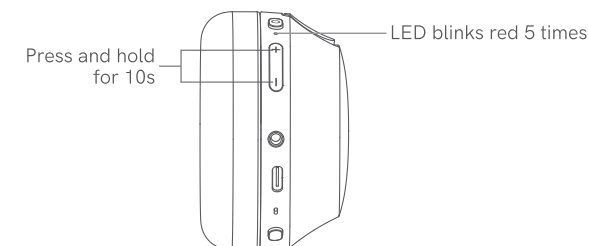

## LED

Connected: LED blinks white every 10s  
BASS mode: LED glows solid white  
Charging: LED glows solid red  
Top-up: LED glows solid white

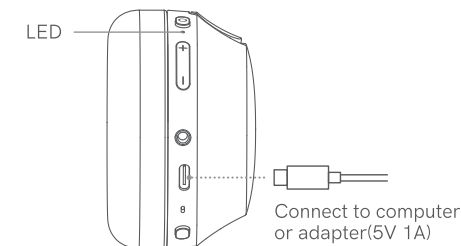

## Functions

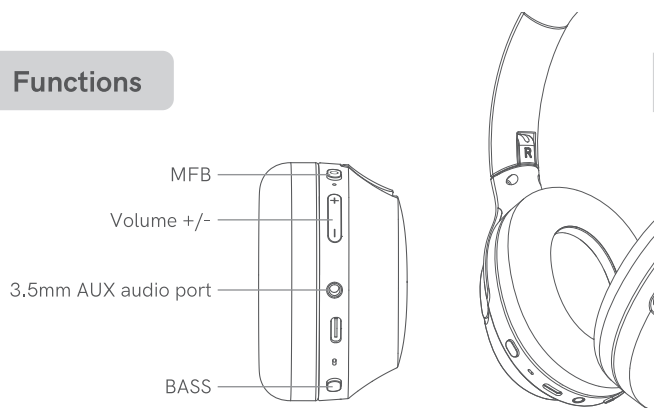

- 🔊 Power-on: Hold MFB for 2s
- 🔊 Power-off: Hold MFB for 4s
- 📞 Answer/end call: Press MFB
- 📞 Ignore call: Hold MFB for 1.5s
- ⏮ Skip track backward: Hold Volume- for 1s
- ⏭ Skip track forward: Hold Volume+ for 1s
- ⏩ Volume up: Press Volume+
- ⏪ Volume down: Press Volume-
- 🗣 Voice assistant: Double press MFB
- 🎵 Playback/pause: Press MFB
- 🔊 Bass mode: Press BASS button
- 🎧 Gaming mode: Triple press MFB

## Warranty Card

Warranty Period  
12 months after you purchase this item (or you may inquire your local shopper for more details).  
Free Service:  
Supposing any defects caused by quality issues occur within the warranty period, please take this warranty card and purchase receipts to your distributor for free exchange service.

Model Number:
Date of Purchasing:
User's Name:
User's Phone:
User's Address:
Shop's Name:
Shop's Address:
Comments:

Free exchange service will not be accessed under following circumstances:  
1. Damages caused unauthorized disassembly.  
2. Defects or physical damages caused by leaking or dropping off.  
3. Damages by act of God. Supposing your item is within any damages or defects except the above circumstances, please return to us or your distributor for free repairing.

## FCC Statement

This equipment has been tested and found to comply with the limits for a Class B digital device, pursuant to Part 15 of the FCC Rules. These limits are designed to provide reasonable protection against harmful interference in a residential installation. This equipment generates uses and can radiate radio frequency energy and, if not installed and used in accordance with the instructions, may cause harmful interference to radio communications. However, there is no guarantee that interference will not occur in a particular installation. If this equipment does cause harmful interference to radio or television reception, which can be determined by turning the equipment off and on, the user is encouraged to try to correct the interference by one or more of the following measures:  
--Reorient or relocate the receiving antenna.  
--Increase the separation between the equipment and receiver.  
--Connect the equipment into an outlet on a circuit different from that to which the receiver is connected.  
--Consult the dealer or an experienced radio/TV technician for help.

This device complies with part 15 of the FCC Rules. Operation is subject to the following two conditions:  
(1) This device may not cause harmful interference, and (2) this device must accept any interference received, including interference that may cause undesired operation.

Changes or modifications not expressly approved by the party responsible for compliance could void the user's authority to operate the equipment.

## Tips

1. Before using the headset, please read the manual carefully and keep it for future references.
2. The headset need to be fully charged prior to first-time use.
3. If the headset are left unused for over two weeks, please recharge.
4. Please use the chargers made by qualified manufacturer.
5. If headset fail to be found by phone, please re-turn them connectable or restore factory settings. If a program error of phone occurs, please turn off and on Bluetooth function or reboot the phone.

## Caveats

1. Never disassemble or modify your headset for any reasons to avoid any damages and danger.
  2. Do not store the headset in extreme temperatures (under 0°C or over 45°C).
  3. Avoid using the indicator close to the eyes of children or animals.
  4. Do not use the headset during a thunderstorm to avoid dysfunction and increasing risk of electricshock.
  5. Do not use harsh chemicals or strong detergents to clean the headset.
- Note: please do not use headset for a long time as may damage your hearing.

Manufacturer: Dongguan Hele Electronics Co., Ltd.  
Address: No. 325 Yuehui Rd. Daojiao Town Dongguan City  
Guangdong Province China



Ovaj dokument je originalno proizveden i objavljen od strane proizvođača, brenda QCY, i preuzet je sa njihove zvanične stranice. S obzirom na ovu činjenicu, Tehnoteka ističe da ne preuzima odgovornost za tačnost, celovitost ili pouzdanost informacija, podataka, mišljenja, saveta ili izjava sadržanih u ovom dokumentu.

Napominjemo da Tehnoteka nema ovlašćenje da izvrši bilo kakve izmene ili dopune na ovom dokumentu, stoga nismo odgovorni za eventualne greške, propuste ili netačnosti koje se mogu naći unutar njega. Tehnoteka ne odgovara za štetu nanесenu korisnicima pri upotrebi netačnih podataka. Ukoliko imate dodatna pitanja o proizvodu, ljubazno vas molimo da kontaktirate direktno proizvođača kako biste dobili sve detaljne informacije.

Za najnovije informacije o ceni, dostupnim akcijama i tehničkim karakteristikama proizvoda koji se pominje u ovom dokumentu, molimo posetite našu stranicu klikom na sledeći link:

<https://tehnoteka.rs/p/qcy-slusalice-h2-pro-crne-akcija-cena/>