

dji OSMO ACTION 4

User Manual

v1.0 2023.08

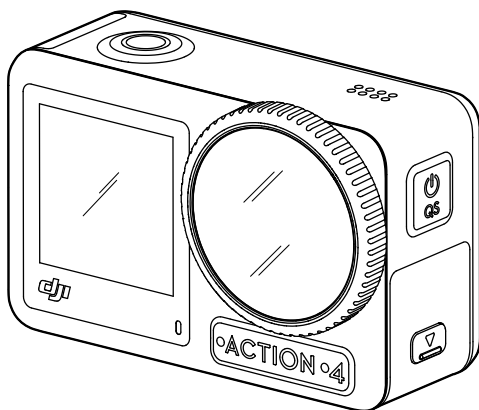



This document is copyrighted by DJI with all rights reserved. Unless otherwise authorized by DJI, you are not eligible to use or allow others to use the document or any part of the document by reproducing, transferring, or selling the document. Users should only refer to this document and the content thereof as instructions to operate DJI products. The document should not be used for other purposes.

Searching for Keywords

Search for keywords such as Battery or Install to find a topic. If you are using Adobe Acrobat Reader to read this document, press Ctrl+F on Windows or Command+F on Mac to begin a search.

Navigating to a Topic

View a complete list of topics in the table of contents. Click on a topic to navigate to that section.

Printing this Document

This document supports high resolution printing.

Using this Manual

Legends

⚠ Important

💡 Hints and Tips

Read Before Use

Read the following documents before using DJI™ OSMO™ Action 4.

1. Osmo Action 4 Safety Guidelines
2. Osmo Action 4 Quick Start Guide
3. Osmo Action 4 User Manual

It is recommended to watch all tutorial videos and read the safety guidelines before using for the first time. Make sure to review the Quick Start Guide before using for the first time and refer to this User Manual for more information.

Download DJI Mimo App and Watch the Tutorial Video

Scan the QR code to download the DJI Mimo App and watch the tutorial videos.

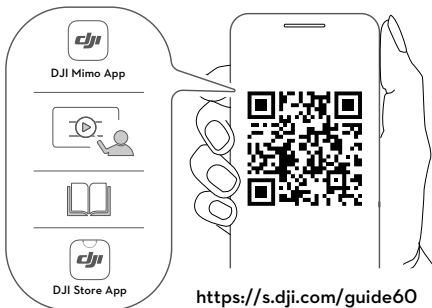

iOS 12.0 or above



Android 8.0 or above

Contents

| | |
|--|-----------|
| Using this Manual | 3 |
| Legends | 3 |
| Read Before Use | 3 |
| Download DJI Mimo App and Watch the Tutorial Video | 3 |
| Contents | 4 |
| Product Profile | 5 |
| Overview | 5 |
| Accessories | 6 |
| Using for the First Time | 9 |
| Attaching the Battery | 9 |
| Inserting the microSD Card | 9 |
| Activating Osmo Action 4 | 10 |
| Charging Osmo Action 4 | 10 |
| Operation | 11 |
| Button Features | 11 |
| Operating the Touchscreen | 11 |
| Status LED Descriptions | 20 |
| Storing Photos and Videos | 20 |
| Transferring Files | 21 |
| Webcam Mode | 22 |
| Microphone Connection | 22 |
| DJI Mimo App | 23 |
| Download the DJI Mimo App | 23 |
| Connecting to the DJI Mimo App | 23 |
| DJI Mimo App Home Screen | 24 |
| Camera View | 25 |
| Maintenance | 27 |
| Firmware Update | 27 |
| Underwater Usage Notes | 27 |
| Cleaning Notes | 28 |
| Battery Usage Notes | 28 |
| Using Other Accessories (Not Included) | 29 |
| Specifications | 32 |

Product Profile

Osmo Action 4 is capable of capturing smooth video at up to 4K/120fps and offers a 155° super-wide FOV. With DJI's latest EIS (Electronic Image Stabilization) technology, Osmo Action 4 can record super smooth footage for various sports scenes. With a 1/1.3-inch image sensor, the camera ensures low-noise footage in sports scenarios and low-light scenes with a high dynamic range or high contrast. In addition, D-Log M color mode provides a more comfortable color perception and a larger dynamic range, which is convenient for post-production color correction.

Osmo Action 4 is equipped with dual touchscreens. The front touchscreen helps capture the perfect selfie, while the rear touchscreen displays the liveview of the camera. Both touchscreens enable users to change the settings with fingertip movements. The buttons on the camera enable users to control recording or switch the shooting mode. Osmo Action 4 is waterproof at depths of up to 18 m. With different Osmo accessories, users can enjoy the full range of Osmo Action 4 features.

Overview

1. Shutter/Record Button
2. Front Touchscreen
3. Lens
4. Status LED I
5. Microphone I
6. Color Temperature Photo Sensor
7. Microphone II
8. USB-C Port
9. USB-C Port Cover
10. USB-C Port Cover Release Button
11. Lens Protective Cover
12. Quick Switch Button
13. Speaker
14. Status LED II
15. Rear Touchscreen
16. Battery Compartment Cover
17. microSD Card Slot
18. Battery Compartment Cover Release Button
19. Windproof Microphone
20. Quick-Release Slot I
21. Quick-Release Slot II

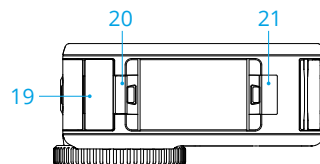
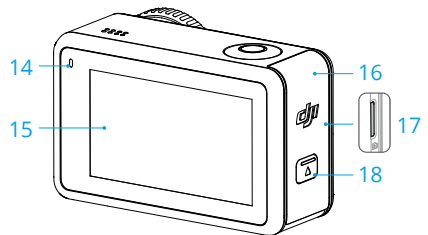
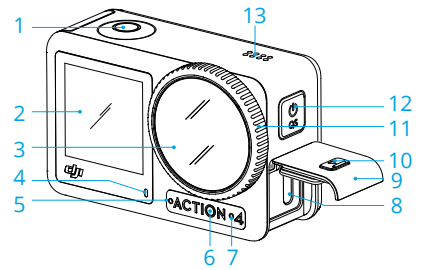



Accessories

Osmo Action 4 is compatible with various accessories to flexibly change the position to shoot various sports scenes.

Osmo Action Curved Adhesive Base Kit

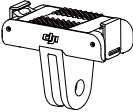
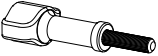
The Osmo Action Curved Adhesive Base Kit includes the following accessories.

| Accessory | Description |
|---|---|
|  | Osmo Action Quick-Release Adapter Mount: with a magnetic design, the quick-release adapter mount can be easily attached to the camera and connected to other accessories. |
|  | Osmo Locking Screw: secures the Osmo Action Quick-Release Adapter Mount to the Osmo Action Curved Adhesive Base. |
|  | Osmo Action Curved Adhesive Base: the base forms a strong, durable, and long-lasting bond on clean and curved surfaces, ensuring secure mounting. |

Press down on the camera until the clips of the quick-release adapter mount are firmly inserted into the quick-release slots on the camera, and then tighten the locking screws. Wipe the surface of the object before attaching the adhesive base. Attach and press the adhesive base down firmly, and hold for at least 10 seconds. It is recommended to wait 30 minutes before attaching the camera.

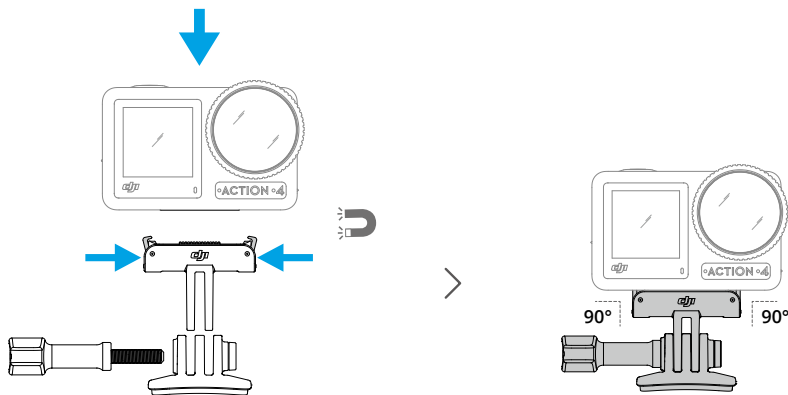

- ⚠️
- Press down on the camera until the clips of the quick-release adapter mount are firmly inserted into the quick-release slots on the camera, and then tighten the locking screws. Press both clips of the quick-release adapter mount when removing the camera.
 - Osmo Action Curved Adhesive Base can only be applied to clean curved surfaces once. DO NOT attach the curved adhesive base to surfaces that are flat, rough, powdered, peeling, covered in dust or sand, or have oil, wax, or water stains. Otherwise, the adapter mount may not be attached firmly.
 - The recommended application temperature for the base is -10° to 40° C (14° to 104° F). DO NOT attach the adhesive base to a surface with a higher or lower temperature.

Osmo Action Horizontal-Vertical Protective Frame

With the Osmo Action Horizontal-Vertical Protective Frame, users can flip the camera from the horizontal to the vertical position for different shooting angles. As shown in the figure below, open the buckle of the horizontal-vertical protective frame, align and place the camera into the frame, and then close the buckle. The left side of the frame is equipped with two quick-release slots, which can be used with the Osmo Action Quick-Release Adapter Mount to fasten other accessories such as the Osmo Action Curved Adhesive Base Kit and the Osmo 1.5m Extension Rod.

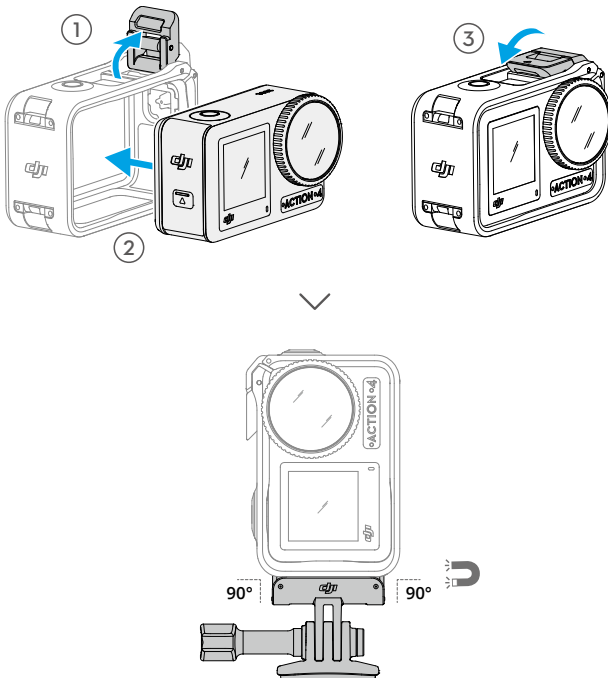

Osmo Action Extreme Battery

The Osmo Action Extreme Battery boosts Osmo Action 4 performance across a wide temperature range from -20° to 45° C (4° F to 113° F). With a 1770 mAh capacity, the battery can continuously work for up to 160 minutes.* Refer to Battery Usage Notes for more detailed information on battery usage.

* Tested at room temperature (25°C/77°F) and 1080p/24fps (16:9), with RockSteady on, Wi-Fi off, and screen off. This data is for reference only.

Osmo Action Multifunctional Battery Case

The Osmo Action Multifunctional Battery Case (hereinafter referred to as the battery case) is designed for storing two microSD cards and three Osmo Action Extreme Batteries safely. Users can check the battery levels by pressing the button once or opening the battery case. The status LEDs will display the battery level. When a charger is connected to the battery case with batteries inserted, the battery case will charge the batteries. When the batteries are inserted into the battery case, with external devices connected to the USB-C port, the batteries can be used as a power bank to charge the connected external devices.

The batteries with the highest power level will be charged first, followed by the remaining batteries to be charged in sequence. The batteries with the lowest power level will be discharged first, followed by the remaining batteries to be discharged in sequence.

When using the battery case to charge the Osmo Action Extreme Battery, it is recommended to use the DJI 30 W USB-C Charger (not included as standard) or a USB-C charger that supports Power Delivery or PPS (Programmable Power Supply). Three batteries can be fully charged in about two hours with the DJI 30 W USB-C Charger.

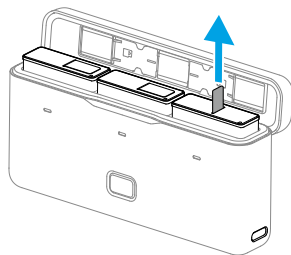

- DO NOT use the battery case to charge non-DJI OSMO batteries. DJI OSMO shall not be responsible for any fault or damage caused by the use of any non-DJI OSMO battery.
- Place the battery case on a flat and stable surface when in use. Make sure the device is properly insulated to prevent fire hazards.
- DO NOT attempt to touch the metal terminals on the battery ports.
- Clean the metal terminals with a clean, dry cloth if there is any noticeable buildup.
- The battery case is not waterproof. DO NOT place it in water or spill any liquid on the case.

Using for the First Time

Attaching the Battery

Press the release button on the battery compartment cover and slide upward, then insert the battery into the battery compartment, as shown below. Make sure the battery is properly inserted, then close the battery compartment cover. Note: if the battery cover is properly mounted, the red marks on the bottom will not be visible.

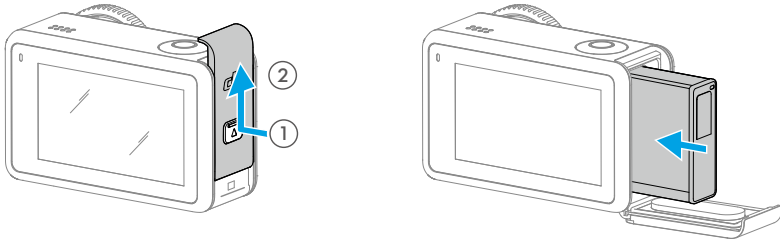

Inserting the microSD Card

The footage shot on Osmo Action 4 is stored on a microSD card. A UHS-I Speed Grade 3 rating microSD card is required due to the fast reading and writing speeds necessary for high-resolution video data. Refer to the recommended microSD card list in Specifications for more information. Insert the microSD card into the microSD card slot as shown.

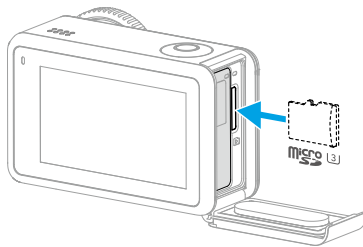

• Gently push the microSD card into the camera to partially eject the microSD card.

Charging Osmo Action 4

Press the release button on the USB-C port cover and slide the cover down.

Connect a USB-C charger (not included) to the USB-C port using the Type-C to Type-C PD cable (included). It is recommended to use the DJI 30 W USB-C Charger or a USB-C charger that supports Power Delivery or PPS (Programmable Power Supply). When the status LEDs turn off, the battery is fully charged. It takes about 18 minutes to charge the battery to 80%. The battery can be fully charged in about 49 minutes.*

* Charging time was tested using a DJI 30 W USB-C Charger in a 25° C (77° F) environment. For reference only.

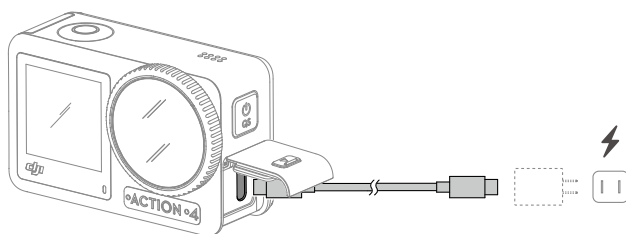

Activating Osmo Action 4

The DJI Mimo app is required for activation when using Osmo Action 4 for the first time. Follow the steps below to activate.

1. Press and hold the Quick Switch Button to power on.
2. Enable Wi-Fi and Bluetooth on the mobile device.
3. Launch DJI Mimo, tap , and follow the instructions to activate Osmo Action 4.

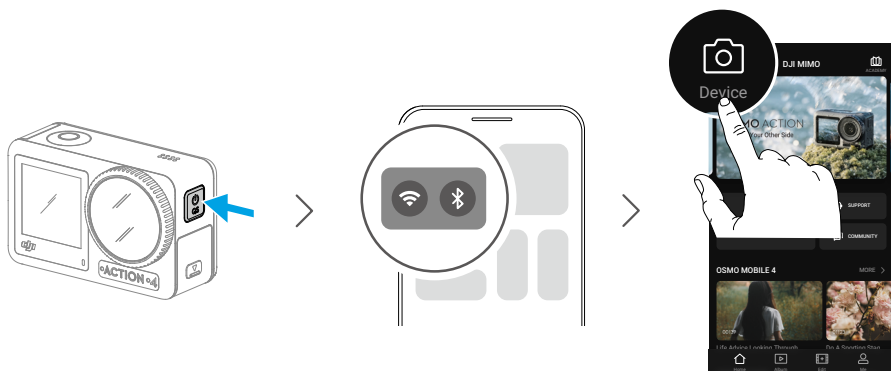

Refer to the relevant sections in [DJI Mimo App](#) for more information on how to operate the app.

Operation

Button Features

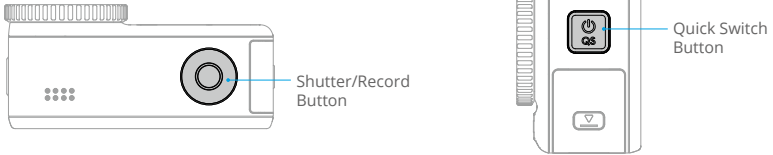

Shutter/Record Button

- Press once: take a photo or start/stop recording.
- Press and hold when powered off: power on quickly and begin shooting. The shooting mode will depend on the SnapShot settings. After shooting, the camera will automatically power off if left idle for three seconds.

Quick Switch Button

- Press and hold: power on/off.
- Press once: switch between shooting modes.

Operating the Touchscreen

After the camera is powered on, both touchscreens of the camera display the liveview as well as the shooting mode, battery level, and microSD card information. Tap or swipe on a touchscreen to interact with the camera. Note: the two touchscreens cannot be operated at the same time. When one touchscreen is operated, the other touchscreen is locked.

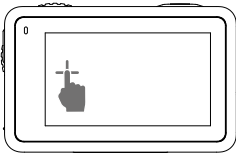
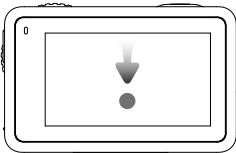
| Operating the Touchscreen | Descriptions |
|---|--|
|  | <p>Tap</p> <p>Select the icons on both sides of the screen to playback shot footage and change the camera settings.</p> |
|  | <p>Swipe Down from the top of the Screen</p> <p>Enters the control menu.</p> |

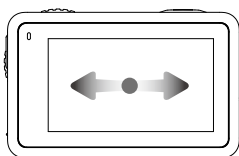

Swipe Left or Right

Switches between video, photo, and other shooting modes.

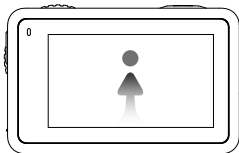

Swipe Up from the Bottom of the Screen

Sets the shooting parameters such as Aspect Ratio, Countdown Timer, and Resolution.

Camera View

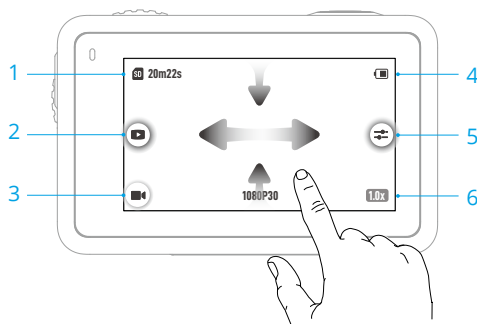

1. Storage Capacity Information

SD 20m22s : the icon displays either the storage capacity, the remaining number of photos or the video duration that can be taken or recorded according to the current shooting mode. The icon is displayed only when a microSD card is inserted.

2. Playback

▶ : tap to preview the last photo or video captured or played back. Swipe from the right to exit playback and go back to liveview.

3. Shooting Modes

📷 : tap the icon and swipe to select the shooting mode.

| Shooting Modes | Description |
|----------------|----------------------------------|
| Take a photo | Take a photo or countdown photo. |
| Video | Record a video. |

Slow Motion Supports 4x or 8x slow-motion video shooting. In Slow Motion mode, the camera records the video with a high frame rate and slows the footage down to 4x or 8x the normal speed during playback. Slow Motion catches details not visible to the naked eye, which is ideal for fast-action shots. Note: slow-motion videos do not include audio. The audio file is stored as a standalone file and has the same path as the videos, which can be transferred to your computer.

Timelapse Select from Hyperlapse and Timelapse. In this mode, the camera turns long events into short videos by taking a frame of video at set intervals.

Use Hyperlapse to record smooth timelapse videos when the camera is in motion (such as in a car or when held in the hand). Use Timelapse to record timelapse videos when the camera is mounted and still.

Three presets in Timelapse are designed for typical scenes such as Crowds, Clouds, and Sunset. Users can also optimize the interval and duration for recording timelapse videos.

4. Battery Level

 : this icon displays the current battery level of Osmo Action 4. Tap the icon to view more detailed information about the battery level.

5. Parameters

 : click to adjust the image and audio parameters. Tap PRO to adjust pro parameters. Various parameters can be set in different shooting modes.

| Shooting Modes | Parameters |
|----------------|---|
| Photo | <p>Basic Mode</p> <p>The FOV and image parameters can be adjusted.</p> <ol style="list-style-type: none"> 1. FOV: the FOV can be set to Standard (Dewarp) or Wide. 2. Image Adjustment: users can adjust the sharpness and noise reduction based on needs for optimal image quality. <p>PRO Mode</p> <p>Exposure, White Balance, FOV, Format, and Image Adjustment are available.</p> <ol style="list-style-type: none"> 1. Exposure: Auto and Manual modes are available. 2. White Balance: Auto and Manual modes are available. 3. FOV: the parameters are same with Basic Mode. 4. Format: select the picture to be stored as JPEG or JPEG+RAW. 5. Image Adjustment: the parameters are same with Basic Mode. |

Video

Basic Mode

FOV, Image Adjustment, EIS Priority in Low Light, and Low-Light Image Enhancement are available.

1. FOV: FOV can be set to Narrow, Standard (Dewarp), Wide, or Ultra Wide. Some FOV options are unavailable when using certain frame rates.
2. EIS Priority in Low Light: enabling EIS Priority in Low Light will remove motion blur and disable anti-flicker function. Image sharpness may be affected when ambient light is too low.
3. Image Adjustment: users can adjust the sharpness and noise reduction based on needs for optimal image quality.
4. Low-Light Image Enhancement: when enabled, the camera will detect low-light environment automatically and adjust exposure parameters intelligently to improve image quality.

PRO Mode

Image and audio parameters can be adjusted.

Image Parameters: Exposure, White Balance, Color, FOV, Image Adjustment, and Low-Light Image Enhancement are available.

- Exposure: Auto and Manual modes are available.
- White Balance: Auto and Manual modes are available.
- Colors: Normal and D-Log M are available. D-Log M is designed for professional color grading in post-editing. In high-contrast or multi-color (e.g., garden, field, etc.) scenarios, it can enlarge the dynamic range for more color-tuning space in post-production. 10-bit color depth enables smoother color transition.
- FOV: the parameters are same with Basic Mode.
- Image Adjustment: the parameters are same with Basic Mode.
- Low-Light Image Enhancement: the parameters are same with Basic Mode.

Audio Parameters: Channel, Wind Noise Reduction, and Gain are available.

- Channel: select from Stereo or Mono.
- Wind Noise Reduction: when enabled, the camera will reduce the wind noise picked up by the built-in microphone using algorithms. Note: Wind Noise Reduction does not work when connected to the external microphone.
- When a microphone is connected, the input gain of the microphone can be adjusted.

Slow Motion

Basic Mode

The FOV and image parameters can be adjusted.

1. FOV: FOV can be set to Standard (Dewarp) or Wide.
2. Image Adjustment: users can adjust the sharpness and noise reduction based on needs for optimal image quality.

PRO Mode

Exposure, White Balance, Color, FOV, and Image Adjustment are available.

1. Exposure: Auto and Manual modes are available.
2. White Balance: Auto and Manual modes are available.
3. Colors: Normal and D-Log M are available. D-Log M is designed for professional color grading when post-editing. In high-contrast or multi-color (e.g., garden, field, etc.) scenarios, it can enlarge the dynamic range for more color-tuning in post-production. 10-bit color depth enables smoother color transition.
4. FOV: the parameters are same with Basic Mode.
5. Image Adjustment: the parameters are same with Basic Mode.

Timelapse

Hyperlapse

Basic Mode: FOV, EIS Priority in Low Light, and Image Adjustment are available.

PRO Mode: Exposure, White Balance, Color, FOV, and Image Adjustment are available.

Timelapse

Basic Mode: FOV and Image Adjustment are available.

PRO Mode: Exposure, White Balance, FOV, Format, and Image Adjustment are available.

6. Zoom

 : press and hold the icon, then drag to set the zoom ratio.

Swipe Down - Control Menu

Swipe down from the edge of the screen to enter the control menu.

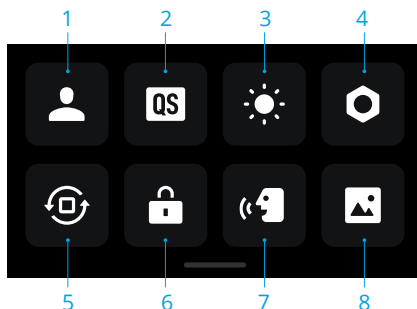

1. Custom Mode

Tap and tap to save the current configuration as a custom mode. Save the shooting parameters in the custom mode, which can then be used directly to shoot similar scenes. Users can save up to five custom modes.

2. Quick Switch

Set the modes accessible with the Quick Switch Button: Screen Switch, Custom Modes, Photo, Video, Slow Motion, Timelapse, Hyperlapse, and Playback. When Voice Prompt is enabled, the camera will voice broadcast the shooting mode once the quick switch button is pressed to change the mode. When the camera is installed on a helmet or other hard-to-see locations, users can accurately select the required mode with Voice Prompt.

3. Brightness

Tap and move the slider to adjust the brightness.

4. Settings

| Item | Description |
|--|--|
| Snapshot | When Osmo Action 4 is powered off or in sleep mode, use Snapshot to quickly power on and begin shooting. Supported shooting modes include Photo, Video, Last Settings, Video, Hyperlapse, and Custom Modes. After shooting, the camera will automatically power off if left idle for three seconds. |
| Single Screen Preview (Scrn Off When Locked) | When enabled, only one touchscreen will turn on. Tap and swipe up on the touchscreen to unlock the screen. |
| Voice Control | Tap to enable voice control to use the camera with voice commands. Mandarin Chinese and English are supported. Voice commands in English include Start Recording, Stop Recording, Take Photo, and Shut Down. |

| | |
|--------------------------|---|
| OTG Connection | Tap OTG Connection and connect the camera to an Android device with the Type-C to Type-C PD cable (included). With OTG connection, the files can be transferred from the camera to an Android device. Note: OTG Connection is only available when the Android device supports OTG connection. |
| Wireless Connection | Tap to check wireless information, select Wi-Fi frequency, and reset the Wi-Fi connection. Connect the camera to DJI Mimo wirelessly to update the firmware version. |
| Video Compression | Tap to switch the video-encoding format between Efficiency and Compatibility modes. If Efficiency is selected, videos will be encoded in HEVC with a smaller file size. If Compatibility is selected, videos will be encoded in H.264 with higher compatibility. |
| Sounds | Tap to set volume. High, medium, low, and mute are available. |
| Grid | Tap to display grid lines in liveview photos or videos to help level the camera vertically and horizontally. The display options include Grid, Diagonals, and Grid & Diagonals. |
| Timecode | Tap to set Timecode for the camera. When setting Timecode, the camera can be synchronized by the system settings. Also, the camera can be synchronized by the time code synchronizer using the USB-C port. |
| Naming Management | Tap to edit the naming rules for storage folders and files. |
| Scrn Off When Rec | Tap to set the time. After recording starts, the screen will turn off after the set time. This will not affect the recording. |
| Auto Power Off | Tap to set the time. The camera will power off automatically when there is no operation on camera within the set duration. |
| LED | Turn the two status LEDs on Osmo Action 4 on or off. |
| Horizon Calibration | Tap to calibrate the horizon according to the prompts on the screen. |
| Continue Last Livestream | Tap to enable, so the camera can continue the last livestream after it has stopped. Note: Livestream is only available on DJI Mimo. |
| Language | Tap to set the language to English, Simplified Chinese, Traditional Chinese, Japanese, Korean, Thai, Arabic, German, Spanish, French, Italian, Russian, Brazilian Portuguese, Turkish, Indonesian, or Polish. |
| Date and Time | Tap to set the date and time of the camera system. |
| Format | Tap and swipe to format the microSD card. Formatting will permanently delete all data on the microSD card. Make sure to back up all required data before formatting. |
| Factory Reset | Tap to restore the camera to its original factory settings. This will delete all the current settings, and the camera will be restored to the original factory settings and restart. |

| | |
|-----------------|---|
| Device Info | Tap to view the device name, serial number, firmware version, quick start guide, and export the log. Tap Export Log to export the log to the microSD card. When the camera is connected to the Osmo Action GPS remote controller, users can view the firmware version of the remote controller. |
| Compliance Info | Tap to view the compliance information. |

5. Orientation Lock

Tap to switch between automatic orientation and locked orientation.

6. Screen Lock

Tap to lock the screen. Swipe up on the touchscreen to unlock the screen.

7. Voice Control

Tap to enable Voice Control so the user can control the camera with set voice commands. Voice Control is useful in the sports scenarios where hands are busy such as when cycling or skiing.

8. Full Front Screen

Tap to enable or disable full screen display on the front screen.

Swipe Up - Parameters Settings

Swipe up from the bottom of the screen to set the parameters for each shooting mode.

| Shooting Modes | Settings |
|----------------|--|
| Photo | Set Aspect Ratio and Countdown Timer. |
| Video | <p>Set video resolution and frame rate.</p> <p>Tap the upper left corner to set the duration of the loop recording. When using loop recording, the camera records a video by overwriting older footage with new footage at selected intervals. Use loop recording when trying to capture a spontaneous moment (e.g., during fishing). This allows the camera to keep recording while saving space on the microSD card.</p> <p>Tap on the upper right corner to turn off EIS and enable RockSteady, RockSteady+, HorizonBalancing, or HorizonSteady. For different resolutions and frame rates, certain EIS modes can only be selected. Different EIS modes have different stabilization performance.</p> <ul style="list-style-type: none"> • Disabled: when selected, record the video with the largest FOV. • RockSteady: stabilizing footage while retaining the dynamics of movement, which is suitable for first-person perspective shooting. • RockSteady+: compared with RockSteady, the edges of these images will be cut off more to obtain stronger stabilization performance. • HorizonBalancing: this mode corrects shakes for any horizontal rotation (45°). In this mode, 4K resolution video is supported. • HorizonSteady: this mode corrects shakes for any horizontal rotation (360°) and locks onto a leveled horizon in every frame, regardless of how the camera is mounted or worn. |
| Slow Motion | Set the video resolution and speed ratio. |
| Hyperlapse | <p>Select Hyperlapse or Timelapse mode. The speed ratio can be set in Hyperlapse mode. The scene, interval time, and shooting time can be set when using Timelapse.</p> <p>Tap the upper right corner to set the resolution when using Timelapse.</p> |

Status LED Descriptions

Osmo Action 4 has two status LEDs which indicate the same status information. They can be turned on and off.

| Blinking Pattern | Description |
|----------------------------------|---|
| Solid green | Ready to use |
| Temporarily off | Taking a photo |
| Blinks green | Osmo Action 4 is charging when powered off |
| Blinks red and green alternately | Updating firmware |
| Blinks red slowly | Recording a video or taking a countdown photo |
| Blinks red three times rapidly | Powers off the camera or powers on the camera at low battery level |
| Off | MicroSD card abnormality (no microSD card detected, microSD card storage is full, or microSD card error.) |

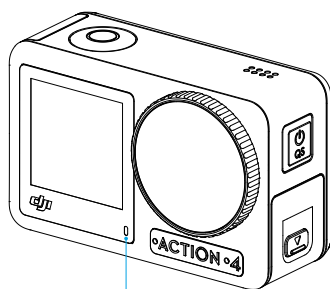

Status LED I

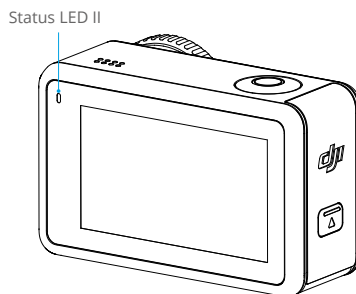

Status LED II

Storing Photos and Videos

The footage shot on Osmo Action 4 can only be stored on a microSD card (not included). A UHS-I Speed Grade 3 rating microSD card is required due to the fast read and write speeds necessary for high-resolution video data. The photos and videos can be transferred to a mobile device or computer. Refer to Transferring Files for detailed information.

Transferring Files

Transferring Files to a Phone

Connect Osmo Action 4 to DJI Mimo, tap the Playback icon to preview photos and videos. Click , to download photos and videos. The photos and videos can be shared directly from DJI Mimo to social media platforms.

Transferring Files to a Computer

Power on Osmo Action 4 and connect it to a computer using a USB-C cable. When connected to a computer, a pop-up will appear, this prompts the user to select the USB connection type on the camera touchscreen. Tap Transfer File to download the files from the camera to the computer. When transferring a file, the camera cannot take photos or record videos.

Select Cancel to only charge Osmo Action 4.

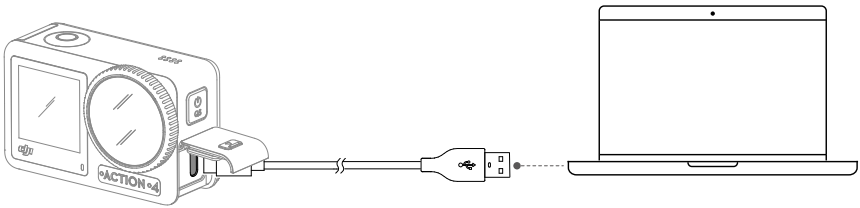

-
-  • Reconnect Osmo Action 4 to the computer if a file transfer is interrupted.
-

OTG Connection for Transferring Files

For the Android devices supporting OTG connection, the files can be transferred from the camera to the Android device with OTG connection.

Connect the camera to an Android device with the Type-C to Type-C PD cable (included) using the USB-C port on the camera. When connected, view and transfer the photos and videos of the camera via the device album or file management.

-
-  • If the camera cannot automatically recognize the Android device using the OTG connection, swipe down from the edge of the screen and enter the control menu. Tap Settings > OTG Connection, and use the Type-C to Type-C PD cable to connect the camera to device.
-

Webcam Mode

Osmo Action 4 can work as a webcam on a computer. Power on the camera and connect it to the computer using a USB-C cable. The camera will go into USB mode. Tap Webcam to enter the Webcam mode, and the camera will function as a webcam input device. The bottom of the screen displays Webcam. Press the shutter/record button to start recording. Tap the Image Parameter Settings icon on the right side of the screen to set the exposure, white balance, and FOV parameters. Users can preview recorded videos after exiting the Webcam mode.

Microphone Connection

Osmo Action 4 can be linked to an external microphone, including DJI Mic or any third-party digital USB-C microphones that support 48K/16bit.

Follow the steps below (with DJI Mic as an example) to connect to a microphone:

1. Press the release button on the USB-C port cover and slide it downward. Lift the cover upward until it is detached from the device.
2. Power on the receiver and transmitter, and make sure the receiver and transmitter are linked.
3. Attach the receiver to the USB-C port of the camera using the USB-C adapter. A microphone icon will be displayed on the screen.
4. Press the linking button on the transmitter to start recording while using the transmitter for audio. Press the linking button again to stop recording.

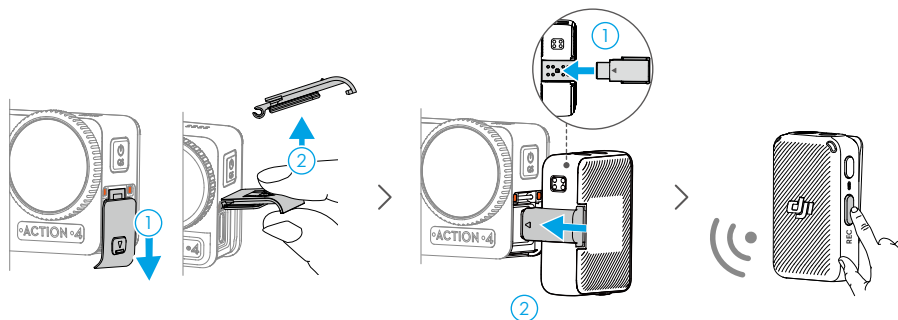

- The transmitter and the receiver are linked by default. Follow the steps below to link if the transmitter and receiver are disconnected.
 - a. Place the transmitter and the receiver in the charging case to link automatically.
 - b. Power on the transmitter and the receiver, press and hold the link button on the transmitter, slide down on the screen of the receiver, select Settings and scroll through and tap Link Device to start linking. The status LED glows solid green to indicate linking was successful.

DJI Mimo App

When used with the DJI Mimo app, users can monitor the current camera view, set the camera parameters, and control the camera with a mobile device. The DJI Mimo app enables user to get most out of Osmo Action 4 with a series of functions, such as transferring files, editing and sharing, InvisiStick for Skiing, and Wi-Fi livestream.

Download the DJI Mimo App

Search DJI Mimo in the app store, or scan the QR code to download and install.



iOS 12.0 or above



Android 8.0 or above

Connecting to the DJI Mimo App

1. Power on Osmo Action 4.
2. Enable Wi-Fi and Bluetooth on the mobile device.
3. Launch DJI Mimo, tap , and follow the instructions to activate Osmo Action 4.







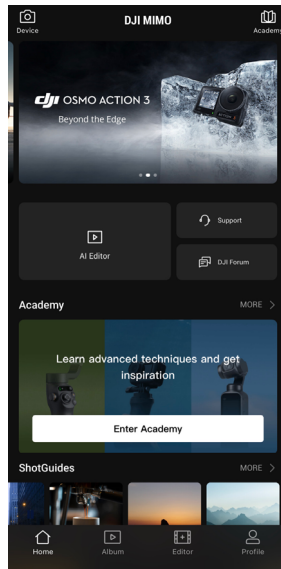

- If there is a problem when connecting to DJI Mimo, follow the steps below.
 - a. Make sure that both Wi-Fi and Bluetooth are enabled on the mobile device.
 - b. Make sure the DJI Mimo app has the latest firmware version.
 - c. Swipe down from the top of the screen to enter the control menu, select Wireless Connection > Reset Connection. The camera will reset all connections and Wi-Fi passwords.

DJI Mimo App Home Screen

Launch DJI Mimo and enter the home screen.



-  **Device:** tap to connect to Osmo Action 4. Once connected, DJI Mimo enters the camera view.
-  **Academy:** tap to watch tutorials and view manuals.
-  **AI Editor:** provides several templates for editing photos or videos.
-  **Home:** tap to return to the home screen.
-  **Album:** manage and view footage from a mobile device or DJI device.
-  **Editor:** tap to edit photos or videos on Osmo Action 4 or import them to and edit on a mobile device.
-  **Profile:** register or log in to a DJI account. View works and settings, check likes and followers, send messages to other users, or connect with the DJI Store.

Camera View

The camera view display may differ depending on the shooting mode. This display is for reference only.



1. Home

 : tap to return to the home screen.

2. Wi-Fi

 : displays Wi-Fi connection.



3. Battery Level

 : displays the current battery level of Osmo Action 4.

4. microSD Card Information

 59:59 : displays either the remaining number of photos that can be taken or the video duration that can be recorded according to the current shooting mode.

5. Custom Mode

 : tap  and tap  to save the current configuration as a custom mode. Save the shooting parameters in the custom mode, which can then be used directly to shoot similar scenes. Users can save up to five custom modes.

6. Shutter/Record Button

 : tap to take a photo or to start or stop recording a video.

7. Shooting Modes

Scroll to select the shooting mode.

| Shooting Modes | Description |
|----------------|--|
| Hyperlapse | Use Hyperlapse to record smooth timelapse videos when the camera is in motion (such as in a car or when hand-held). Tap Playback to preview timelapse videos as soon as they are captured. |
| Timelapse | Use Timelapse to record timelapse videos when the camera is mounted and still. Three presets in Timelapse are designed for typical scenes such as Crowds, Clouds, and Sunset. Users can also optimize the interval and duration for recording timelapse videos. |
| Slow Motion | Supports 4x or 8x slow-motion video shooting. In Slow Motion mode, the camera records the video with a high frame rate and slows the footage down to 4x or 8x the normal speed during playback. Slow Motion catches details not visible to the naked eye, which is ideal for fast-action shots. Note: slow-motion videos do not include audio. The audio file is stored as a standalone file and has the same path as the videos, which can be transferred to your computer. |
| Video | Record a video. |
| Photo | Take a photo or countdown photo. |
| Live Stream | Osmo Action 4 supports live broadcasting to livestream platforms such as YouTube and Facebook. |

8. Playback

: tap to preview photos and videos as soon as they are captured.

9. Settings

⋮: set the selected shooting mode as Basic or Pro mode. More settings become available once Pro is enabled, including FOV, Format, Exposure and White Balance. Various parameters can be set when using different shooting modes.

10. Shooting Parameters

: displays the parameters of the current shooting mode. Tap to set the parameters.

11. Zoom

: displays the current zoom ratio. Place two fingers on the screen and move them apart to zoom in or pinch together to zoom out.

Maintenance

Firmware Update

The firmware version of Osmo Action 4 is updated using DJI Mimo.

Make sure the battery level of Osmo Action 4 is at least 15% before updating its firmware version. Connect Osmo Action 4 to the DJI Mimo app. If new firmware is available, users will be notified by DJI Mimo. Update the firmware according to the on-screen instructions. The update takes approximately 2 minutes.

Underwater Usage Notes

Osmo Action 4 can be used underwater at depths of up to 18 m. When used with the Osmo Action 60m waterproof case, the device can operate underwater up to 60 m deep. Observe the following precautions when using the device in water.

1. Make sure the battery and battery compartment are dry and clean before inserting the battery. Otherwise, it may affect the battery contact and waterproofing ability. Make sure the battery compartment cover is firmly fastened after the battery is inserted. Note: if the cover is properly mounted, the red marks on the bottom will not be visible.
2. Make sure the USB-C port cover is clean and closed before using. Otherwise, it will affect the device waterproofing ability.
3. Make sure the lens protective cover is clean and closed before using. Otherwise, it will affect the device waterproofing ability. Make sure the lens protective cover and lens are dry and clean. Sharp or hard objects may damage the lens and affect the ability of the device. Make sure the lens protective cover are firmly mounted and fastened.
4. Osmo Action 4 is not waterproof unless the battery compartment cover, USB-C port cover, and lens protective cover are firmly mounted and fastened. The camera is NOT waterproof when used with Osmo Action Lens Hood.
5. Avoid jumping into water at high speed with Osmo Action 4. Otherwise, the impact may result in water seepage. Make sure the camera is waterproofed before jumping into water.
6. DO NOT use Osmo Action 4 in hot springs or extreme underwater environments. DO NOT let Osmo Action 4 to come into contact with corrosive or unknown liquids.
7. Rinse the camera with clean water after using it underwater. Allow it to dry naturally before using again. DO NOT dry the camera with hot air using a hair dryer, otherwise the microphone membrane and the built-in breathable membrane will rupture, and the camera will no longer be waterproof.

Attach the waterproof case to Osmo Action 4 when using it while diving, surfing, underwater for an extended period, or in other situations involving high water impact. Observe the following precautions when using the device with the waterproof case:

1. Make sure the rubber seal is clean and firmly attached during use.
2. Make sure the waterproof case is dry (for best results, place anti-fog fiber in the case during use) and the latch is secure.

3. Before use, it is recommended to place the waterproof case underwater for approximately 5 minutes to ensure it is working properly.
4. Rinse the case with tap water to prevent corrosion after using it in the sea.



- The touchscreens of Osmo Action 4 can be operated when their surface is wet.
 - The touchscreens cannot function underwater. Users can press the camera buttons to start recording. Shutter/record button is disabled automatically when the camera is used without Osmo Action waterproof case at a depth of more than 14 m.
-

Cleaning Notes

1. Clean the lens protective cover with water or a lens cleaning pen, lens air blower, or lens cleaning cloth. When changing the lens protective cover, make sure the camera is dry. After using Osmo Action 4 in water, let the camera dry before using it again. This will prevent water from seeping into the lens protective cover and fogging up the lens. DO NOT remove the lens protective cover frequently to avoid dust accumulating inside the lens cover, which can affect shooting quality.
2. Clean the lens with a lens cleaning pen, lens air blower, or lens cleaning cloth.
3. Clean the battery and battery compartment with a clean, dry cloth.

Make sure the quick-release slots on the camera are clean from dust and sand when attaching the Quick-Release Adapter Mount.

Battery Usage Notes

1. DO NOT use non-DJI OSMO batteries. New batteries can be purchased at www.dji.com. DJI OSMO shall not be responsible for any fault or damage caused by the use of any non-DJI OSMO batteries.
2. The battery should be used at temperatures between -20° to 45° C (-4° to 113° F). Use of the battery at temperatures above 45° C (113° F) can lead to a fire or explosion. Before using the battery in a low-temperature environment, it is recommended to charge the battery fully in a normal temperature environment. Charging the battery at the ideal temperature can prolong battery life.
3. Battery performance will be affected if the battery is not used for an extended period.
4. Discharge and charge the battery completely once every three months to keep it in good working condition.
5. Remove the battery from Osmo Action 4 and store the battery in the Osmo Action Multifunctional Battery Case when stored for an extended period.

Using Other Accessories (Not Included)

Accessory

Osmo 1.5m Extension Rod

Diagram

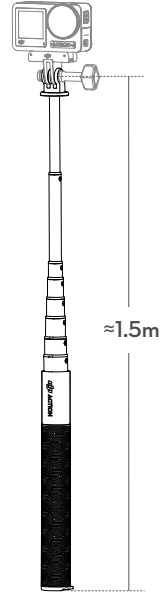

1. Adjust the telescopic length of the extension rod appropriately when in use.
2. DO NOT drop or strike the extension rod in any way when in use to avoid damage.
3. DO NOT shake the extension rod violently when installed with the camera to avoid damage.
4. Rinse with clean water to remove sand after underwater usage.
5. DO NOT use the extension rod during thunderstorms to avoid lightning strikes.

Osmo Magnetic Ball-Joint Adapter Mount

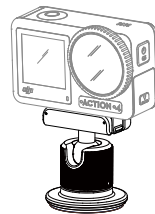

Osmo Action 60m Waterproof Case

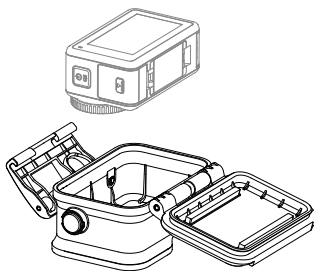

DJI Floating Handle

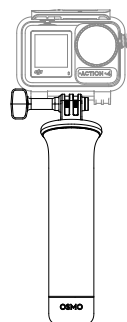

Osmo Action Suction Cup Mount

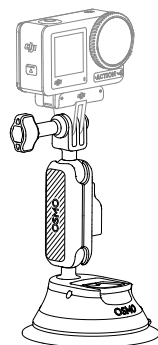

Osmo Action Helmet Chin Mount

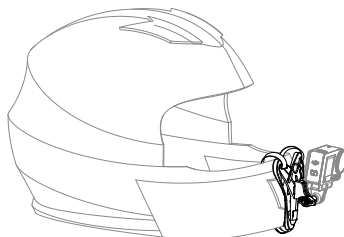

Osmo Action Chest Strap Mount

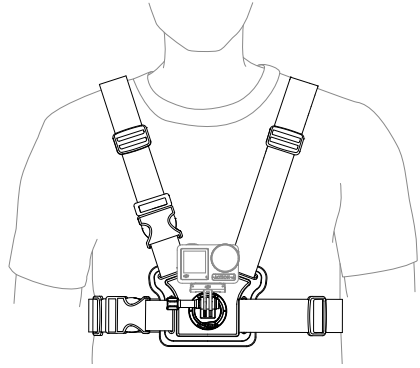

Osmo Action Handlebar Mount

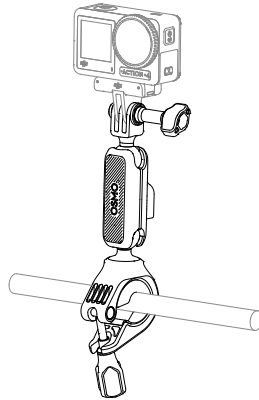

Osmo Action GPS Bluetooth Remote Controller

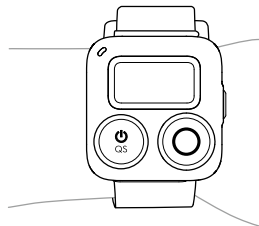

Support for DJI devices will be updated continuously. Visit <https://www.dji.com/osmo-action-4> for a complete list.

Specifications

| General | |
|---------------------------|---|
| Dimensions | 70.5×44.2×32.8 mm (L×W×H) |
| Weight | 145 g |
| Waterproof | 18 m ^[1] without the Waterproof Case, 60 m with the Waterproof Case |
| Number of Microphones | 3 |
| Touchscreens | Front Screen: 1.4-inch 323 ppi 320×320 Rear Screen: 2.25-inch 326 ppi 360×640 Front/Rear Screen Brightness: 750±50 cd/m ² |
| Supported SD Cards | microSD (up to 512 GB) |
| Recommended microSD Cards | Recommended models: SanDisk Extreme Pro 32GB V30 A2 UHS-I Speed Grade 3 Kingston Canvas Go!Plus 64GB UHS-I Speed Grade 3 Kingston Canvas Go!Plus 128GB UHS-I Speed Grade 3 Kingston Canvas React Plus 64GB UHS-II Speed Grade 3 Kingston Canvas React Plus 128GB UHS-II Speed Grade 3 Kingston Canvas React Plus 256GB UHS-II Speed Grade 3 Lexar Pro 256GB SDXC UHS-I V30 R160/W120 (1066x) Lexar Pro 512GB SDXC UHS-I V30 R160/W120 (1066x) |
| Camera | |
| Sensor | 1/1.3-inch CMOS |
| Lens | FOV: 155° Aperture: f/2.8 Focus Range: 0.4 m to ∞ |
| ISO Range | Photo: 100-12800 Video: 100-12800 |
| Electronic Shutter Speed | Photo: 1/8000-30 s Video: 1/8000 s to the limit of frames per second |
| Max Photo Resolution | 3648×2736 |
| Zoom | Digital Zoom Photo: 4× Video: Max 2× Slow Motion/Timelapse: not available |
| Still Photography Modes | Single: Approx. 10 MP Countdown: Off/0.5/1/2/3/5/10 s |

| | |
|---------------------------|--|
| Standard Recording | 4K (4:3): 3840×2880@24/25/30/48/50/60fps 4K (16:9): 3840×2160@100/120fps 4K (16:9): 3840×2160@24/25/30/48/50/60fps 2.7K (4:3): 2688×2016@24/25/30/48/50/60fps 2.7K (16:9): 2688×1512@100/120fps 2.7K (16:9): 2688×1512@24/25/30/48/50/60fps 1080p (16:9): 1920×1080@100/120/200/240fps 1080p (16:9): 1920×1080@24/25/30/48/50/60fps |
| Slow Motion | 4K: 4× (120fps) 2.7K: 4× (120fps) 1080p: 8× (240fps), 4× (120fps) |
| Hyperlapse | 4K/2.7K/1080p: Auto/×2/×5/×10/×15/×30 |
| Timelapse | 4K/2.7K/1080p@30fps Intervals: 0.5/1/2/3/4/5/6/8/10/15/20/25/30/40 s Duration: 5/10/20/30 mins, 1/2/3/5 hours, ∞ |
| Stabilization | EIS ^[2] : RockSteady 3.0 RockSteady 3.0+ HorizonBalancing HorizonSteady |
| Max Video Bitrate | 130 Mbps |
| Supported File System | exFAT |
| Photo Format | JPEG/RAW |
| Video Format | MP4 (H.264/HEVC) |
| Built-in Storage Capacity | The camera does not have built-in storage, but storage capacity can be expanded by inserting a microSD card. |
| Audio Output | 48 kHz 16-bit; AAC |
| Battery | |
| Type | LiPo 1S |
| Capacity | 1770 mAh |
| Energy | 6.8 Wh |
| Voltage | 3.85 V |
| Operating Temperature | -20° to 45° C (-4° to 113° F) |
| Charging Temperature | 5° to 40° C (41° to 104° F) |
| Operating Time | 160 minutes ^[3] |
| Connection | |
| Wi-Fi Operating Frequency | 2.4000-2.4835 GHz 5.150-5.250 GHz 5.725-5.850 GHz |

| | |
|---------------------------------|---|
| Wi-Fi Protocol | 802.11 a/b/g/n/ac |
| Wi-Fi Transmitter Power (EIRP) | 2.4 GHz: < 15 dBm (FCC/CE/SRRC/MIC) 5.1 GHz: < 16 dBm (FCC/CE/SRRC/MIC) 5.8 GHz: < 14 dBm (FCC/CE/SRRC) |
| Bluetooth Operating Frequency | 2.400-2.4835 GHz |
| Bluetooth Transmit Power (EIRP) | <3 dBm |
| Bluetooth Protocol | BLE 5.0 |

- [1] Before use, close the battery compartment cover and the USB-C port cover, and tighten the Lens Protective Cover. It is recommended to install the Waterproof Case for long-duration underwater shooting or in environments with high water impact pressure. Osmo Action 4 and its Waterproof Case have an IP68 waterproof rating. Do not use the camera in hot springs or extreme underwater environments, or let it come into contact with corrosive or unknown liquids.
- [2] EIS is not supported in Slow Motion and Timelapse modes. HorizonSteady is only available when the video resolution is 1080p (16:9) or 2.7K (16:9) with a frame rate of 60fps or below. HorizonBalancing is only available when the video resolution is 1080p (16:9), 2.7K (16:9), or 4K (16:9) with a frame rate of 60 fps or below.
- [3] Tested at room temperature (25°C/77°F) and 1080p/24fps (16:9), with RockSteady on, Wi-Fi off, and screen off. This data is for reference only.

WE ARE HERE FOR YOU



Contact
DJI SUPPORT

This content is subject to change.



<https://www.dji.com/osmo-action-4/downloads>

If you have any questions about this document, please contact DJI by sending a message to **DocSupport@dji.com**.

DJI and OSMO are trademarks of DJI.
Copyright © 2023 DJI OSMO All Rights Reserved.