

Uputstvo za upotrebu (EN)

RAZER bežični miš Viper Ultimate roze

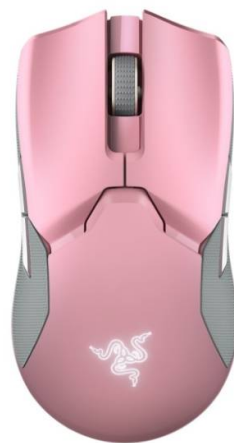

Tehnoteka je online destinacija za upoređivanje cena i karakteristika bele tehnike, potrošačke elektronike i IT uređaja kod trgovinskih lanaca i internet prodavnica u Srbiji. Naša stranica vam omogućava da istražite najnovije informacije, detaljne karakteristike i konkurentne cene proizvoda.

Posetite nas i uživajte u ekskluzivnom iskustvu pametne kupovine klikom na link:

<https://tehnoteka.rs/p/razer-bezicni-mis-viper-ultimate-roze-akcija-cena/>

UPDATE: 15 OCTOBER 2019

PRODUCT MANUAL FOR GAMING MOUSE

MODEL: RC30-030501

WHAT'S INSIDE

GAMING MOUSE (MODEL: RC30-030501)

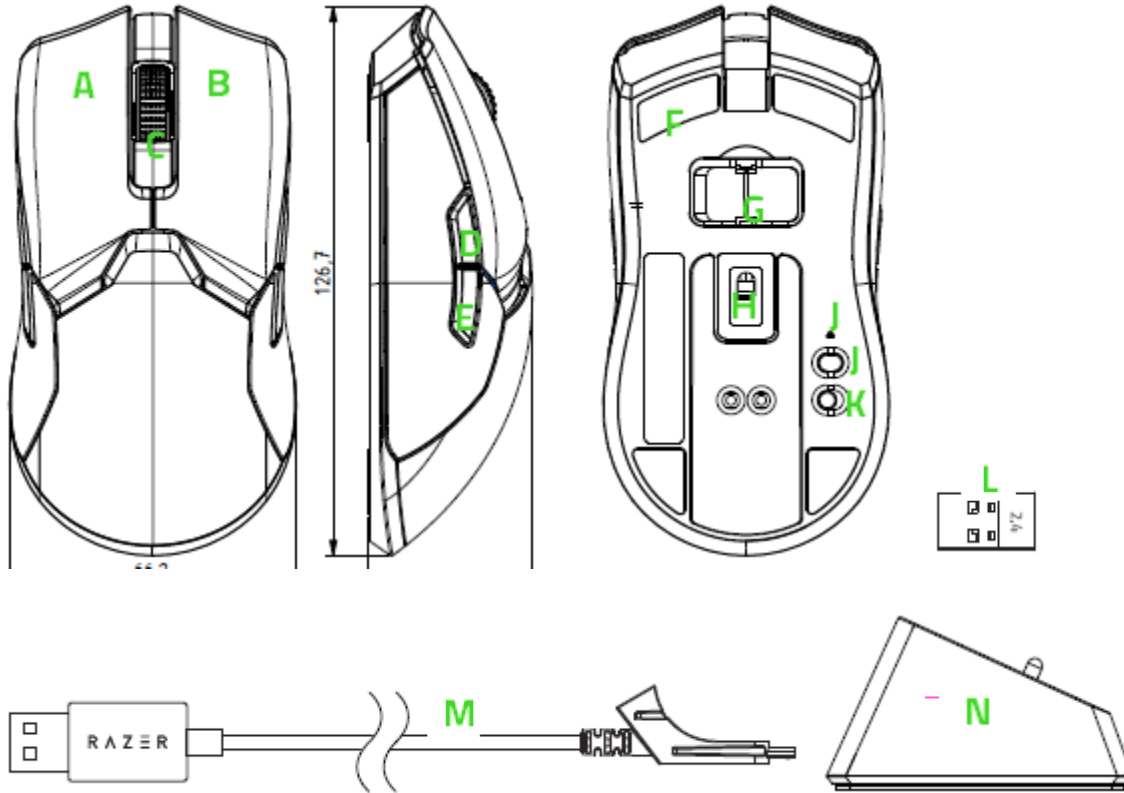

[PLACEHOLDER IMAGE]

- A. Left mouse button
- B. Right mouse button
- C. Scroll wheel
- D. Mouse button 5
- E. Mouse button 4
- F. Ultraslick mouse feet
- G. Wireless USB dongle compartment
- H. True 20,000 DPI 5G optical sensor
- I. DPI indicator
- J. DPI cycle up button
- K. Power on/off switch
- L. Wireless USB dongle
- M. Charging Cable
- N. Charging Dock

Default DPI stages are as follows: 400, 800, 1800, 2400, and 3200. The DPI stages can be customized using Razer Synapse 3.

WHAT'S NEEDED

PRODUCT REQUIREMENTS

- PC with a free USB port

RAZER SYNAPSE REQUIREMENTS

- Windows®7 64-bit (or higher)
- Internet connection
- 500 MB of free hard disk space

LET'S GET YOU COVERED

You've got a great device in your hands complete with a 2-year limited warranty coverage. Now maximize its potential and score exclusive Razer benefits by registering at razerid.razer.com

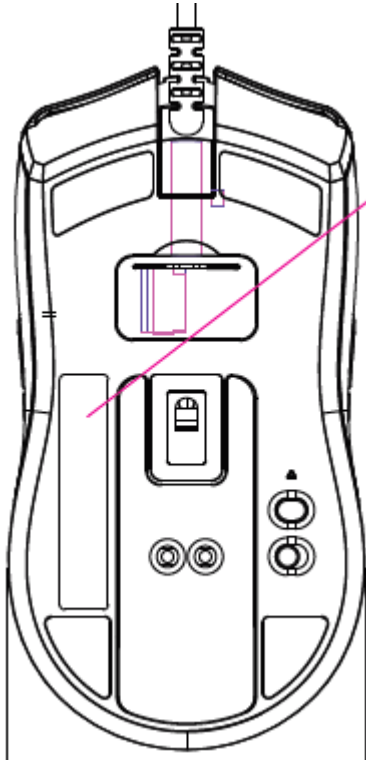

Your product's serial number can be found

[PLACEHOLDER IMAGE]

GETTING STARTED

CHARGING YOUR RAZER VIPER ULTIMATE

Plug the charging cable from your computer's USB port to your Viper Ultimate.

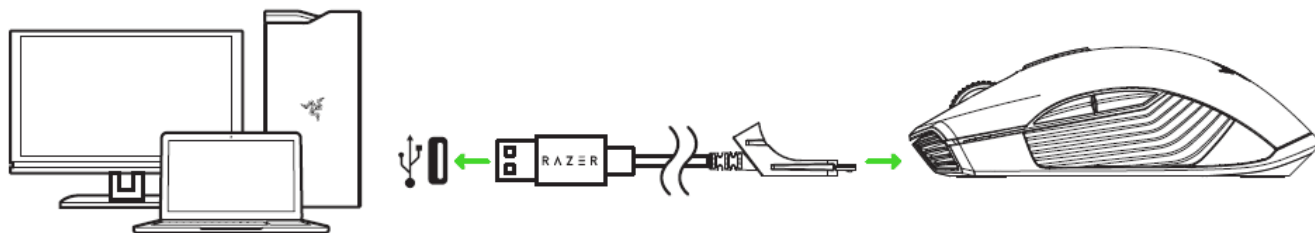

[PLACEHOLDER IMAGE]

i This connection also acts as the wired mode for your Razer device.

For best results, please fully charge your Razer Viper Ultimate before using it for the first time. A depleted battery will be fully charged in approximately **4 hours**. If the Razer Viper Ultimate has not been used for an extended period, you may need to recharge it before use.

The Razer Viper Ultimate requires a USB connection that is able to supply sufficient power to charge the battery. The battery charging process of the Razer Viper Ultimate may be affected if connected to a non-powered USB hub or non-powered USB ports found on certain keyboards and other peripherals. When in doubt, it is preferable to connect the Razer Viper Ultimate directly to the USB port of your computer.

LOW POWER INDICATOR

The Razer Viper Ultimate's scroll wheel will blink red twice in repeated intervals to indicate that the battery's power is less than **25%**. This lighting sequence will repeat until the battery is drained or the mouse is connected to the PC via the charging cable.

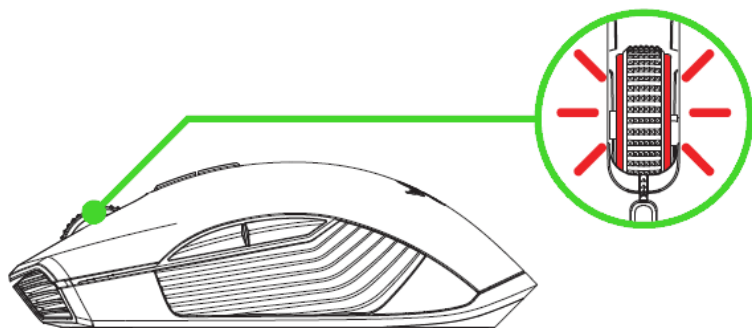

[PLACEHOLDER IMAGE]

i The indicator percentage can be customized using Razer software.

USING THE USB WIRELESS DONGLE

1. Remove the compartment cover from your Razer Viper Ultimate.

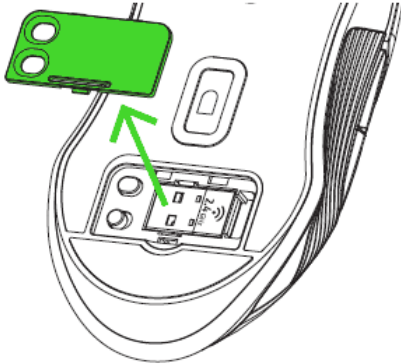

[PLACEHOLDER IMAGE]

2. Remove the USB wireless dongle from your mouse.

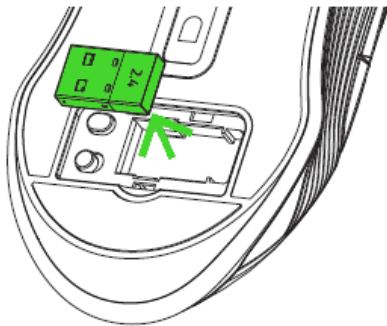

[PLACEHOLDER IMAGE]

3. Reattach the compartment cover onto your Razer Viper Ultimate and make sure it is securely fastened.

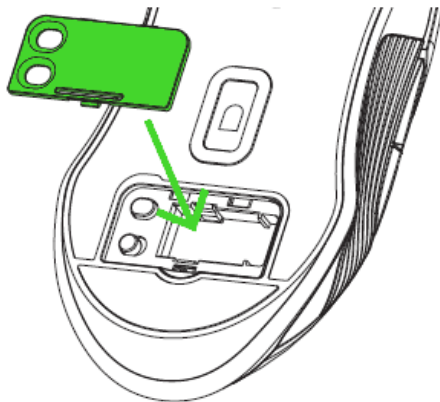

[PLACEHOLDER IMAGE]

4. Insert the USB wireless dongle into your computer's USB port.



[PLACEHOLDER IMAGE]

5. Switch on the Razer Viper Ultimate.

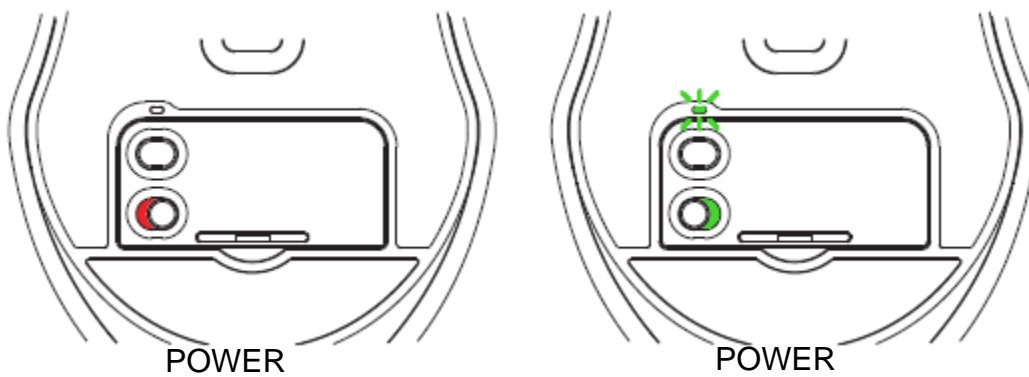

[PLACEHOLDER IMAGE]

Your Razer Viper Ultimate is now ready for use in wireless mode.

USING THE CHARGING DOCK

1. Plug the charging cable from your computer's USB port to the charging dock.

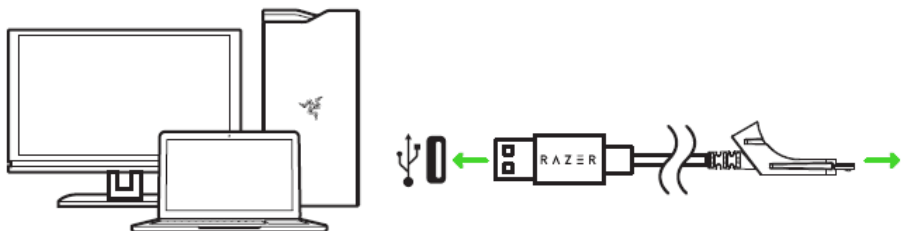

[PLACEHOLDER IMAGE]

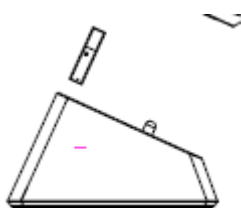

2. Insert the USB wireless dongle into your computer's USB port.



[PLACEHOLDER IMAGE]

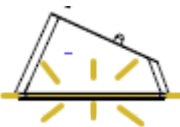

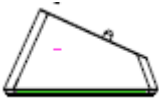

You can use the charging dock to replenish your mouse's battery and to extend the reach of your USB wireless dongle. You can also connect to Razer Synapse and place your Razer Viper Ultimate on the charging dock to view the mouse's current battery status.

| Color | Battery Percentage | Effect |
|--------|--------------------|--|
| Red | <25% | Breathing  |
| Yellow | 26%-50% | Breathing  |
| Orange | 51%-75% | Breathing |

| | | |
|-------|---------|--|
| | |  |
| Green | 76%-99% | Breathing  |
| Green | 100% | Static  |

PERSONALIZE YOUR MOUSE

Change your mouse's DPI to match your playstyle with a press of the DPI cycle button or fine-tune your own sensitivity setting using the Razer Synapse app!

| DPI | Designated color | [PLACEHOLDER IMAGE] |
|-------------------|------------------|---|
| 400 | Red |  |
| 800 | Green |  |
| 1800 (Default) | Blue |  |
| 2400 | Cyan |  |
| 3200 | Yellow |  |

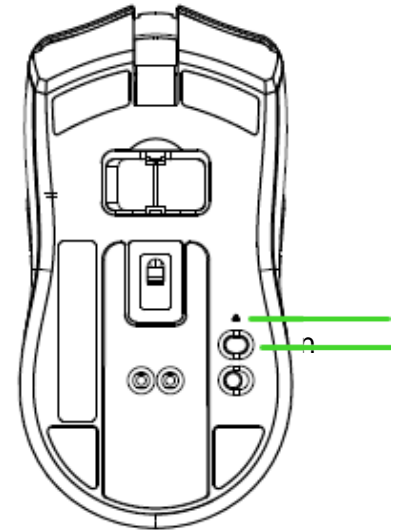

Note: Install Razer Synapse when prompted or download the installer from razer.com/synapse.

Find out more about your brand new mouse at support.razer.com

LEGALESE

COPYRIGHT AND INTELLECTUAL PROPERTY INFORMATION

©2019 Razer Inc. All rights reserved. Razer, the triple-headed snake logo, Razer logo, “For Gamers. By Gamers.”, and “Powered by Razer Chroma” logo are trademarks or registered trademarks of Razer Inc. and/or affiliated companies in the United States or other countries. All other trademarks and trade names are the property of their respective owners and other company and product names mentioned herein may be trademarks of their respective companies.

Windows and the Windows logo are trademarks of the Microsoft group of companies.

Razer Inc. (“Razer”) may have copyright, trademarks, trade secrets, patents, patent applications, or other intellectual property rights (whether registered or unregistered) concerning the product in this guide. furnishing of this guide does not give you a license to any such copyright, trademark, patent or other intellectual property right. The Razer Viper Ultimate (the “Product”) may differ from pictures whether on packaging or otherwise. Razer assumes no responsibility for such differences or for any errors that may appear. Information contained herein is subject to change without notice.

LIMITED PRODUCT WARRANTY

For the latest and current terms of the Limited Product Warranty, please visit [razer.com/warranty](https://www.razer.com/warranty).

LIMITATION OF LIABILITY

Razer shall in no event be liable for any lost profits, loss of information or data, special, incidental, indirect, punitive or consequential or incidental damages, arising in any way out of distribution of, sale of, resale of, use of, or inability to use the Product. In no event shall Razer’s liability exceed the retail purchase price of the Product.

GENERAL

These terms shall be governed by and construed under the laws of the jurisdiction in which the Product was purchased. If any term herein is held to be invalid or unenforceable, then such term (in so far as it is invalid or unenforceable) shall be given no effect and deemed to be excluded without invalidating any of the remaining terms. Razer reserves the right to amend any term at any time without notice.

SAFETY AND MAINTENANCE

SAFETY GUIDELINES

In order to achieve maximum safety while using your Razer Hammerhead True Wireless Earbuds, we suggest that you adopt the following guidelines:

Should you have trouble operating the device properly and troubleshooting does not work, unplug the device and contact the Razer hotline or go to support.razer.com for assistance.

Do not take apart the device (doing so will void your warranty) and do not attempt to operate it under abnormal current loads.

Keep the device away from liquid, humidity or moisture. Operate the device only within the specific temperature range of 0°C (32°F) to 40°C (104°F). Should the temperature exceed this range, unplug and/or switch off the device in order to let the temperature stabilize to an optimal level.

The device isolates external ambient sounds even at low volumes, resulting in lowered awareness of your external surroundings. Please remove the device when engaging in any activity that requires active awareness of your surroundings.

Listening to excessively loud volume over an extended period of time can damage your hearing. Furthermore, legislation of certain countries permits only a maximum sound level of 86dB for 8 hours a day. We therefore recommend that you reduce the volume to a comfortable level when listening for prolonged periods of time. Please, take good care of your hearing.

FCC Statement

This equipment has been tested and found to comply with the limits for a Class B digital device, pursuant to part 15 of the FCC Rules. These limits are designed to provide reasonable protection against harmful interference in a residential installation. This equipment generates uses and can radiate radio frequency energy and, if not installed and used in accordance with the instructions, may cause harmful interference to radio communications. However, there is no guarantee that interference will not occur in a particular installation. If this equipment does cause harmful interference to radio or television reception, which can be determined by turning the equipment off and on, the user is encouraged to try to correct the interference by one or more of the following measures:

- Reorient or relocate the receiving antenna.
- Increase the separation between the equipment and receiver.
- Connect the equipment into an outlet on a circuit different from that to which the receiver is connected.
- Consult the dealer or an experienced radio/TV technician for help.

FCC Radiation Exposure Statement

This device complies with FCC radiation exposure limits set forth for an uncontrolled environment and it also complies with Part 15 of the FCC RF Rules. This equipment must not be co-located or operating in conjunction with any other antenna or transmitter. End-users and installers must be provide with antenna installation instructions and consider removing the no-collocation statement.

This device complies with Part 15 of the FCC Rules. Operation is subject to the following two conditions: (1) this device may not cause harmful interference, and (2) this device must accept any interference received, including interference that may cause undesired operation.

Caution!

Any changes or modifications not expressly approved by the party responsible for compliance could void the user's authority to operate the equipment.

Canada Statement

This device contains licence-exempt transmitter(s)/receiver(s) that comply with Innovation, Science and Economic Development Canada's licence-exempt RSS(s). Operation is subject to the following two conditions:

- (1) This device may not cause interference.
- (2) This device must accept any interference, including interference that may cause undesired operation of the device.

L'émetteur/récepteur exempt de licence contenu dans le présent appareil est conforme aux CNR d'Innovation, Sciences et Développement économique Canada applicables aux appareils radio exempts de licence. L'exploitation est autorisée aux deux conditions suivantes :

- 1) L'appareil ne doit pas produire de brouillage;
- 2) L' appareil doit accepter tout brouillage radioélectrique subi, même si le brouillage est susceptible d' en compromettre le fonctionnement.

The device meets the exemption from the routine evaluation limits in section 2.5 of RSS 102 and compliance with RSS-102 RF exposure, users can obtain Canadian information on RF exposure and compliance.

Le dispositif rencontre l'exemption des limites courantes d'évaluation dans la section 2.5 de RSS 102 et la conformité à l'exposition de RSS-102 rf, utilisateurs peut obtenir l'information canadienne sur l'exposition et la conformité de rf.



STATEMENT OF
COMPLIANCE WITH EU DIRECTIVE ENGLISH

ENGLISH

STATEMENT OF COMPLIANCE WITH EU DIRECTIVE

Hereby, Razer (Europe) GmbH, declares that this Razer Mamba Wireless (Gaming Mouse Model: RC30-030501 and USB Dongle Model: DGRFG6) is in compliance with the essential requirements and other relevant provisions of Directive 2014/53/EU.

Gaming Mouse:

Operating Frequency: 2403-2479MHz

Max Output power: 9.99dBm

USB Dongle:

Operating Frequency: 2403-2479MHz

Max Output power: 3.60±2dBm

SW version: V1.0

The full Declaration of Conformity can be requested via the following:

Company: Razer (Europe) GmbH

Address: **Essener Bogen 23**, 22419 Hamburg, Germany

E-mail: compliance@razer.com

Internet address: <https://www.razer.com>

Ovaj dokument je originalno proizveden i objavljen od strane proizvođača, brenda Razer, i preuzet je sa njihove zvanične stranice. S obzirom na ovu činjenicu, Tehnoteka ističe da ne preuzima odgovornost za tačnost, celovitost ili pouzdanost informacija, podataka, mišljenja, saveta ili izjava sadržanih u ovom dokumentu.

Napominjemo da Tehnoteka nema ovlašćenje da izvrši bilo kakve izmene ili dopune na ovom dokumentu, stoga nismo odgovorni za eventualne greške, propuste ili netačnosti koje se mogu naći unutar njega. Tehnoteka ne odgovara za štetu nanесenu korisnicima pri upotrebi netačnih podataka. Ukoliko imate dodatna pitanja o proizvodu, ljubazno vas molimo da kontaktirate direktno proizvođača kako biste dobili sve detaljne informacije.

Za najnovije informacije o ceni, dostupnim akcijama i tehničkim karakteristikama proizvoda koji se pominje u ovom dokumentu, molimo posetite našu stranicu klikom na sledeći link:

<https://tehnoteka.rs/p/razer-bezicni-mis-viper-ultimate-roze-akcija-cena/>