

Uputstvo za upotrebu (EN)

HAMA Fit Watch 4910 roze pametni sat

The HAMA logo is displayed in a bold, italicized, red sans-serif font. It is positioned on a white background that is part of a large white trapezoidal shape on a dark blue background.

Tehnoteka je online destinacija za upoređivanje cena i karakteristika bele tehnike, potrošačke elektronike i IT uređaja kod trgovinskih lanaca i internet prodavnica u Srbiji. Naša stranica vam omogućava da istražite najnovije informacije, detaljne karakteristike i konkurentne cene proizvoda.

Posetite nas i uživajte u ekskluzivnom iskustvu pametne kupovine klikom na link:

<https://tehnoteka.rs/p/hama-fit-watch-4910-roze-pametni-sat-akcija-cena/>

SMART WATCH

Fit Watch 4910

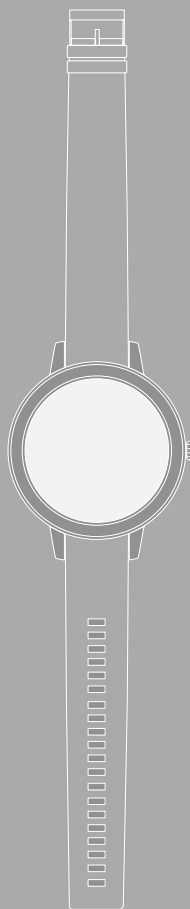

GB Operating Instructions





1. Explanation of warning symbols and notes	5
2. Package contents	5
3. Safety instructions	6
4. Control elements	8
5. Getting started	9
5.1 Charging	9
5.2 Putting on and turning on	9
5.3 Turning off	9
6. Setting up your smart watch	10
6.1 Download the "Hama FIT move" app	10
6.2 Pairing the smart watch and smartphone	11
7. Operating your smart watch	13
7.1 Home screen	15
7.2 Notifications	15
7.3 Quick Settings	15
7.3.1 Do Not Disturb mode	15
7.3.2 Wake screen	15
7.3.3 Display brightness	15
7.3.4 Telephone search	15
7.4 Shortcuts	16
7.5 Applications	16
7.5.1 Daily overview	16
7.5.2 Activity	17
7.5.2.1 Outdoor running	17
7.5.2.2 Running	18
7.5.2.3 Outdoor walking	18
7.5.2.4 Walking	18
7.5.2.5 Hiking	19
7.5.2.6 Outdoor cycling	19
7.5.2.7 Yoga	19
7.5.2.8 Spinning	19
7.5.2.9 Yoga	20
7.5.2.10 Spinning	20
7.5.2.11 Fitness	20
7.5.2.12 Swimming in a pool	20
7.5.2.13 Wild swimming	21
7.5.2.14 Rowing machine	21
7.5.2.15 Cross-trainer	21
7.5.2.16 Dancing	21
7.5.2.17 Pilates	21
7.5.3 Exercise record	22
7.5.4 Heart rate	22
7.5.5 Stress	22
7.5.6 Sleep	22
7.5.7 Blood oxygen	22
7.5.8 Breath training	22



7.5.9 Music	22
7.5.10 Timer	23
7.5.11 Stopwatch	23
7.5.12 Alarm clock	23
7.5.13 Weather	23
7.5.14 Telephone search	23
7.5.15 Settings	24
8. Using the "Hama FIT move" app	25
8.1 "Hama FIT move" overview	25
8.1.1 Health data	26
8.1.2 Step measurement	27
8.1.3 Training	28
8.1.4 Sleep analysis	29
8.1.5 Heart rate measurement	30
8.1.6 Stress measurement	31
8.1.7 Blood oxygen	32
8.1.8 Weight recording	33
8.1.9 Menstruation cycle	34
8.2 Activity mode	35
8.2.1 Start activity (with GPS)	36
8.2.2 Start activity (without GPS)	38
8.3 Device settings	40
8.3.1 Home screen	41
8.3.2 Notifications	41
8.3.3 Incoming calls	41
8.3.4 Alarm clock	42
8.3.5 Health monitoring	42
8.3.5.1 Continuous heart rate measurement	42
8.3.5.2 Continuous stress measurement	43
8.3.5.3 Drinking reminder	43
8.3.5.4 Walking/walk around reminder	43
8.3.5.5 Tracking the menstrual cycle	43
8.3.6 More settings	44
8.3.6.1 Do Not Disturb mode	44
8.3.6.2 Automatic activity detection	44
8.3.6.3 Type of training	45
8.3.6.4 Telephone search	45
8.3.6.5 Music control	45
8.3.6.6 Arm movement activation	45
8.3.6.7 Weather push	45
8.3.6.8 Automatic brightness at night	45
8.3.6.9 Shortcuts	46
8.3.6.10 Smart watch language setting	46
8.4 User settings	47
8.4.1 Personal details	48
8.4.2 My medals	49
8.4.3 My data	49
8.4.4 Health report	50
8.4.5 Messages	50



8.4.6 Settings	51
8.4.7 Help	52
8.4.8 Questions and suggestions	52
8.4.9 Troubleshooting	52
8.4.10 Check for updates	52
8.4.11 About	52
9. Care and maintenance	53
10. Warranty disclaimer	53
11. Technical data	53
12. Disposal instructions	53
13. Declaration of conformity	53

EXPLANATION OF WARNING SYMBOLS AND NOTES

Thank you for choosing a Hama product.

Take your time and read the following instructions and information completely. Please keep these instructions in a safe place for future reference.

Your new smart watch is your ideal companion for a healthy lifestyle and motivates you to stay active all day long. As well as displaying the time and date, it collects data about the number of steps you have taken, your heart rate and the calories you have burned. The wireless connection via *Bluetooth*[®] to your smartphone enables you to document the data on the associated "Hama FIT move" app and therefore constantly keep track of your success. Check here when you have reached your personal fitness goal!

1. Explanation of warning symbols and notes

Warning



This symbol is used to indicate safety instructions or to draw your attention to specific hazards and risks.

Note



This symbol is used to indicate additional information or important notes.



2. Package contents

- "Fit Watch 4910" smart watch
- 1 USB charging cable
- Operating instructions

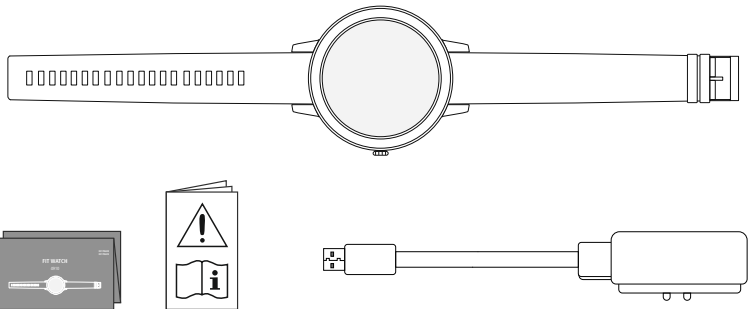



3. Safety instructions

- This product is intended for private, non-commercial use only.
- Use the product only for the intended purpose.
- Protect the product from dirt, moisture and overheating and use it in dry environments only.
- Do not use the product in the immediate vicinity of heaters, other heat sources or in direct sunlight.
- Do not operate the product outside the power limits given in the specifications.
- Do not use the product in areas in which electronic products are not permitted.
- The battery is integrated and cannot be removed.
- Do not open the device or continue to operate it if it becomes damaged.
- Do not attempt to service or repair the product yourself. Leave any and all service work to qualified experts.
- Do not drop the product and do not expose it to any major shocks.
- Do not modify the product in any way. Doing so voids the warranty.
- Dispose of packaging material immediately in accordance with the locally applicable regulations.
- Do not incinerate the battery or the product.
- Do not tamper with or damage/heat/disassemble the batteries/rechargeable batteries.
- While driving a car or using sports equipment, do not allow yourself to be distracted by your product and keep an eye on the traffic situation and your surroundings.
- Consult your doctor before starting an exercise programme.
- Always be aware of your body's response when you exercise, and speak to your doctor in an emergency.
- Consult your doctor if you have a medical condition and wish to use the product.
- This is a consumer product, not a medical device. Hence, it is not intended for the diagnosis, therapy, cure or prevention of illnesses.
- Prolonged contact with the skin can lead to skin irritations and allergies. Consult a doctor if symptoms persist.
- This product is not a toy. It contains swallowable small parts that pose a suffocation hazard.
- Only use the article under moderate climatic conditions.



Risk of electric shock



- Do not open the device or continue to operate it if it becomes damaged.
- Do not use the product if the AC adapter, adapter cable or power cable is damaged.
- Do not attempt to service or repair the product yourself. Leave any and all service work to qualified experts.

Warning - cardiac pacemakers



This product generates magnetic fields. Persons with a cardiac pacemaker should consult a doctor before using this product, as the pacemaker's proper function could be affected.

Information - Flying



- This product is a constant transmitter of radio signals. Please be aware that carrying and using radio transmitters during certain phases of the flight (e.g. take-off / landing) is not permitted for safety reasons.
- Check with your airline before you fly whether your fitness tracker can be taken on board. If in doubt, leave the product at home.

Warning - rechargeable battery



- Only use suitable charging devices or USB ports to charge the product.
- Do not use defective chargers or USB ports and do not attempt to repair them.
- Do not overcharge the product or allow the battery to completely discharge.
- Avoid storing, charging and using in extreme temperatures and at extremely low atmospheric pressures (such as at high altitudes).
- When stored over a long period of time, batteries should be charged regularly (at least every three months).



4. Control elements

1. Control button
2. Full-touch display
3. Removable strap
4. Closure
5. Charging contact

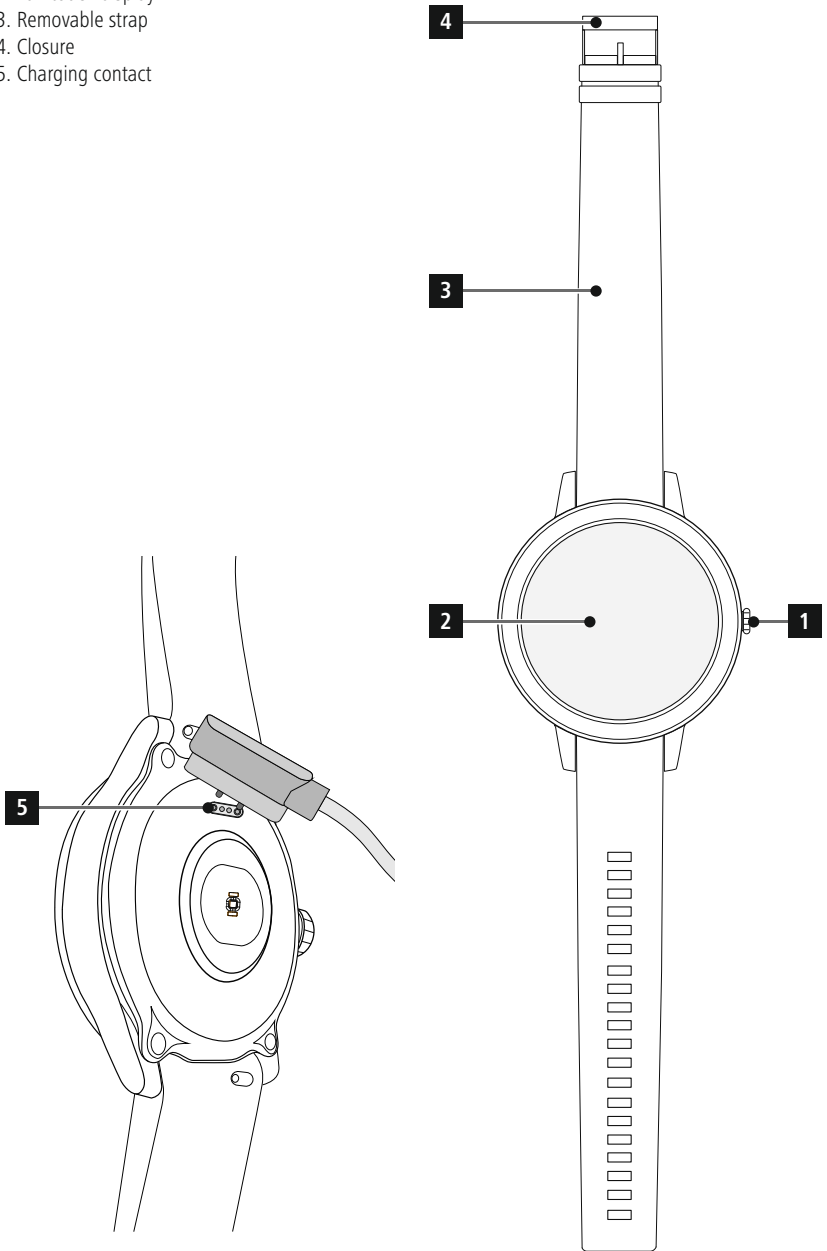



5. Getting started

5.1 Charging

- Charge your smart watch fully before using it for the first time.
- Connect the charging cable to a free USB port on your computer or a USB charger and the charging contact [5] on your smart watch. To do this, consult the operating instructions for the USB charger you are using.

Note



- The charging time for a full battery charge is around 90 minutes. As soon as the battery shown in the display is fully charged, the charging process is complete and you can disconnect your smart watch from the charging cable.
- When the battery charge level reaches only 10%, please charge the smart watch in order to avoid limited functionality. When the battery level is below 20%, you can no longer start an activity, and when the battery level is below 10%, the automatic heart rate measurement function is deactivated.

5.2 Putting on and turning on

- Before putting on and turning on your smart watch for the first time, you must connect it with the enclosed charging cable and plug it into a power source.
- After successful charging, put your smart watch on your wrist and close the wristband [3] using the clasp [4].
- Hold the control button on the side [1] down for 3 seconds to start your smart watch.

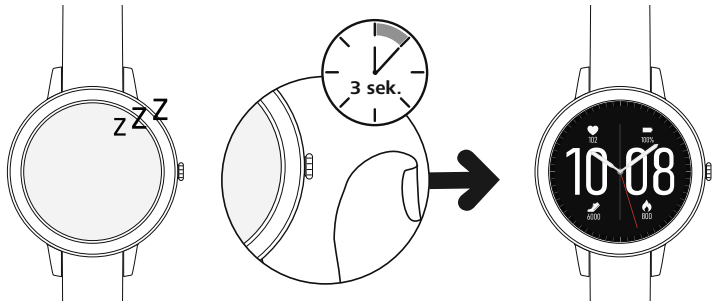



Note



- To use the measuring functions most effectively, your smart watch should be positioned close to the skin on the top of the forearm but still be pleasant to wear. The distance between the smart watch and the bones of the wrist should be about one finger breadth.
- To ensure the best possible recording of your activities, wear your smart watch on your left wrist if you are right-handed and on your right wrist if you are left-handed.

5.3 Turning off

- To turn off your smart watch, switch to the [SETTINGS ] menu item (see Section 7.5.15 Settings) and tap [TURN OFF ] in the sub-menu. Confirm the subsequent question to turn off your smart watch.



6. Setting up your smart watch

To access the full range of functions of your smart watch, install the "Hama FIT move" app. The following sections contain information on downloading and setting up the app.

6.1 Download the "Hama FIT move" app

Note



The following operating systems are supported:

- iOS 9.0 or higher
- Android 6.0 or higher

After turning on your smart watch for the first time, you will be prompted to download the corresponding app "Hama FIT move" on your smartphone. A corresponding QR code is shown on the display of your smart watch.

- Scan the QR code with your smartphone or download the app from the Play Store (Android) or the App Store (iOS):



[Hama FIT move Android](https://www.hama.com/hama-fit-move-android)

<https://www.hama.com/hama-fit-move-android>



[Hama FIT move iOS](https://www.hama.com/hama-fit-move-ios)

<https://www.hama.com/hama-fit-move-ios>

- To install the app, follow the instructions on your smartphone.



6.2 Pairing the smart watch and smartphone

Note





- In order for the smart watch to display incoming calls, text messages, WhatsApp messages and other notifications, activate push mode for messages in your smartphone settings.
- While setting up the app, you will be asked whether the app has permission to access the functions of your terminal device. Say yes to these prompts for the full functionality of your smart watch.

- Launch the app on your smartphone and agree to the privacy agreement. Answer any questions that may be asked.

For an optimal user experience, you should create a user account. By creating a user account, you can also access your personal data if you change smartphones. This means that your personal data is available at all times. However, creating a user account is not a prerequisite for using the app.

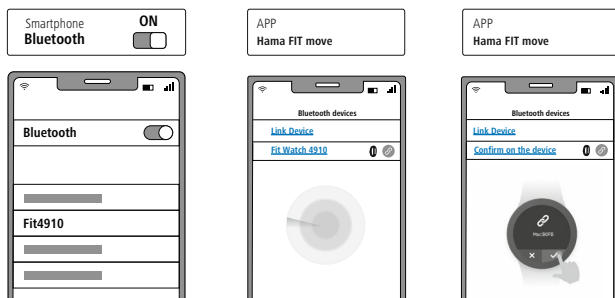
- To create a user account, please tap **[LOG IN]** and select **[REGISTER NOW]** at the bottom of the screen. Enter an e-mail address and a password and please tap **[LOG IN]**.
- You can then enter a user name and your personal data and set a profile picture. Please tap **[NEXT STEP]** to continue setup.
- The search for your "Fit Watch 4910" smart watch then starts.
- Follow the instructions in the app on your smartphone to connect your smart watch.
Your smartphone will establish a Bluetooth connection to your smart watch.



- Now select "Watch4910" and please tap **[PAIR THE DEVICE]** at the bottom to connect your smart watch to the app.
- Please tap the  icon on the display of your smart watch to confirm the connection and complete the setup in the app.
- If there is a timeout, repeat the process.



- Then make your personal settings. These can be adapted later in the app (see Section **8.4 User settings**).
- Your smart watch is now linked with the app and synchronisation begins.

Note



- Please synchronise your smart watch with the app before using it for the first time. If you record an activity before your smart watch has been synchronised with the app for the first time, the activity will not be transferred to the app afterwards.
- To manually start a synchronisation of the smart watch with the app, drag the screen downwards on the app home page.
- Due to your smart watch's limited storage space, you should synchronise your smart watch with the app regularly (at least once a week) to avoid data loss.

Note



- After the first synchronisation with the app, your smart watch automatically adopts the time, date and language from your smartphone.
- The time and date cannot be set manually.
- The display language of your smart watch depends on your selection in the app. As long as the setup is not completed, the display language remains English. Select the desired display language in the app (see Section **8.3.6.10 Smart watch language setting**).
- The app will alert you when a firmware update is available for your smart watch. Perform the update in the app to ensure proper functioning of your smart watch.



7. Operating your smart watch

The following sections contain information on the operation and menu structure of your smart watch.

- Press the side control button **[1]** to activate the display on your smart watch. You can then swipe the display to switch between the different views and menu items in the order shown below.
- You can access the sub-menus by tapping on the respective symbol.
- Press the side control button **[1]** to leave a menu and jump back to the home screen.

Note



- The following graphic is an overview of the menu structure of your smart watch with all menu items.

Notifications 7.2

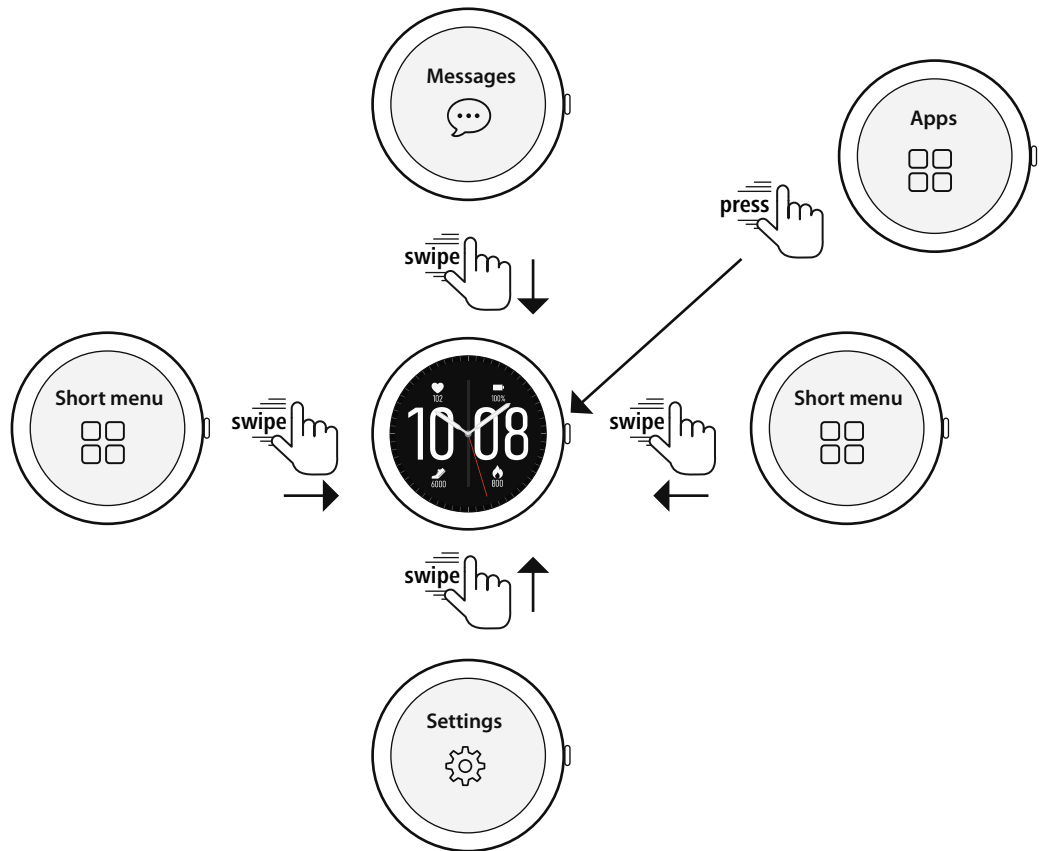

Shortcuts (optional)		7.4
	Step measurement	7.5.2
	Heart rate measurement	7.5.4
	Stress measurement	7.5.5
	Music	7.5.9
	Weather	7.5.13

Quick settings		7.3
	Do Not Disturb mode	7.3.1
	Wake screen	7.3.2
	Display brightness	7.3.3
	Telephone search	7.3.4

Applications		7.5
	Daily overview	7.5.1
	Activity	7.5.2
	Exercise record	7.5.3
	Heart rate	7.5.4
	Stress	7.5.5
	Sleep	7.5.6
	Blood oxygen	7.5.7
	Breath training	7.5.8
	Music	7.5.9
	Timer	7.5.10
	Stopwatch	7.5.11
	Alarm clock	7.5.12
	Weather	7.5.13
	Telephone search	7.5.14
	Settings	7.5.15



7.1 Home screen

- After activating the home screen, a long press on the display gives you an overview of the different home screens (watch faces). Here you can choose between three different home screens. Confirm your selection by tapping on the respective home screen. If required, you can install further home screens (see Section **8.3.1 Home screen**).



7.2 Notifications

- If you swipe down from the home screen, you will see notifications that you have received on your smartphone. The prerequisite is that you have activated this function in the app. You can also set in the app from which apps you want to receive notifications on your smart watch (see Section **8.3.2 Notifications**).
- Depending on the app, you will either only receive a notification with a display of the app in question and the sender or you will also see a preview of the message.
- By tapping on a notification, you can call up further information if necessary, and by tapping on the recycle bin, you can delete the notification.
- If you want to delete all notifications together, swipe all the way down and then tap the Trash and confirm the subsequent prompt.

7.3 Quick Settings

- If you swipe up from the home screen, you will see the four quick settings described below.

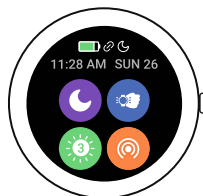

7.3.1 Do Not Disturb mode

- Please tap the [🌙] symbol to enable/disable Do Not Disturb mode. When Do Not Disturb mode is activated, no notifications are forwarded to your smart watch.

7.3.2 Wake screen

- Please tap the [👋] symbol to turn on the display by moving your arm. When this function is enabled, you can switch on the display by turning your wrist.

7.3.3 Display brightness

- Please tap the [☀️] symbol to adjust the brightness of the display. You can choose between three levels [🌑] [🌒] [🌓].

7.3.4 Telephone search

- Please tap the [📞] symbol to start the telephone search and find your misplaced smartphone. Your smartphone starts vibrating or you hear a loud signal tone.
- Please tap the [📞] symbol again to end the telephone search.



7.4 Shortcuts

- Swipe left or right from the home screen to see your set shortcuts.
By default, the daily activity overviews are set. You can see your health data (number of steps walked and calories burned), as well as heart rate and stress measurements. You can set the weather notification and music control as additional shortcuts (see Section **8.3.6.9 Shortcuts**).

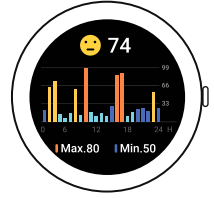

7.5 Applications

- Press the side control button **[1]** to access the main menu of your smart watch.
- In the main menu you have the option of calling up various applications and sub-menus by tapping on the respective symbol.
- Swipe up and down to switch between the different pages in the main menu.





7.5.1 Daily overview

- Tapping the **[DAILY OVERVIEW **] symbol displays the data of the recorded daily activities.
Daily activities include steps walked, calories burned, distance travelled (steps and activities) and total time of all activities performed. Swipe from bottom to top to scroll through the individual graphics.





7.5.2 Activity

- By tapping the **[ACTIVITY **] symbol, you will be shown various activity modes that are currently stored on the watch by default. You can choose from various activity modes and store up to eight different activity modes on the watch (see Section **8.3.6.3 Type of training**). Tapping on the respective activity starts it. The individual activity modes are explained in more detail below.
- Press the side control button **[1]** to pause or resume an activity.
- Pressing and holding the side control button **[1]** ends the activity.
- After completing the activity, you will receive an overview of the recorded data.
- By tapping the **[**] symbol next to an activity, you can make further settings. You can set targets for the Distance, Duration and Calorie categories. When the target is reached, the activity ends automatically.



Note



- In many activities, you can listen to music while exercising. To do this, music control must be enabled in the app (see Section **8.3.6.5 Music control**).

7.5.2.1 Outdoor running

- Start the activity by tapping the arrow at the bottom right.
- The following data is recorded during this activity:
 - Distance
 - Duration
 - Heart rate
 - Heart rate zone
 - Calorie consumption
 - Steps
 - Steps per minute
 - Pace (km/h, min/km and average pace)
 - Route covered
- You can access the individual data during the activity by swiping left and right on the screen. During this activity, you can also control the music on your smartphone by swiping all the way to the right.



7.5.2.2 Running

- The following data is recorded during this activity:
 - Distance
 - Duration
 - Heart rate
 - Calorie consumption
 - Steps
 - Pace (km/h and min/km)
- You can access the individual data during the activity by swiping left and right on the screen. During this activity, you can also control the music on your smartphone by swiping all the way to the right.

7.5.2.3 Outdoor walking

- Start the activity by tapping the arrow at the bottom right.
- The following data is recorded during this activity:
 - Distance
 - Duration
 - Heart rate
 - Calorie consumption
 - Steps
 - Pace (km/h and min/km)
 - Route covered
- You can access the individual data during the activity by swiping left and right on the screen. During this activity, you can also control the music on your smartphone by swiping all the way to the right.

7.5.2.4 Walking

- The following data is recorded during this activity:
 - Distance
 - Duration
 - Heart rate
 - Calorie consumption
 - Steps
 - Pace (km/h and min/km)
- You can access the individual data during the activity by swiping left and right on the screen. During this activity, you can also control the music on your smartphone by swiping all the way to the right.



7.5.2.5 Hiking

- Start the activity by tapping the arrow at the bottom right.
- The following data is recorded during this activity:
 - Distance
 - Duration
 - Heart rate
 - Calorie consumption
 - Steps
 - Pace (km/h and min/km)
 - Route covered
- You can access the individual data during the activity by swiping left and right on the screen. During this activity, you can also control the music on your smartphone by swiping all the way to the right.

7.5.2.6 Outdoor cycling

- Start the activity by tapping the arrow at the bottom right.
- The following data is recorded during this activity:
 - Distance
 - Duration
 - Heart rate
 - Calorie consumption
 - Pace (km/h and min/km)
 - Route covered
- You can access the individual data during the activity by swiping left and right on the screen. During this activity, you can also control the music on your smartphone by swiping all the way to the right.

7.5.2.7 Yoga

- The following data is recorded during this activity:
 - Duration
 - Heart rate
 - Calorie consumption
- During this activity, you can also control the music on your smartphone by swiping all the way to the right.

7.5.2.8 Spinning

- The following data is recorded during this activity:
 - Duration
 - Heart rate
 - Calorie consumption
- During this activity, you can also control the music on your smartphone by swiping all the way to the right.



7.5.2.9 Yoga

- The following data is recorded during this activity:
 - Duration
 - Heart rate
 - Calorie consumption
- During this activity, you can also control the music on your smartphone by swiping all the way to the right.

7.5.2.10 Spinning

- The following data is recorded during this activity:
 - Duration
 - Heart rate
 - Calorie consumption
- During this activity, you can also control the music on your smartphone by swiping all the way to the right.

7.5.2.11 Fitness

- The following data is recorded during this activity:
 - Duration
 - Heart rate
 - Calorie consumption
- During this activity, you can also control the music on your smartphone by swiping all the way to the right.

7.5.2.12 Swimming in a pool

- When starting the activity, the pool length is asked for. Here you can set a length between 25 m and 100 m. Then you can start the activity by tapping the arrow at the bottom right.
- The following data is recorded during this activity:
 - Distance
 - Duration
 - Arm strokes per pool length
 - SWOLF value
- The SWOLF value is a measure of swimming efficiency. The SWOLF value is the sum of the time needed for one pool length and the number of arm strokes per pool length. The lower the SWOLF value, the higher your swimming efficiency.
- Example: If you need a time of 30 seconds for a pool length of 25 metres and do 30 arm strokes, then your SWOLF value is 60.



7.5.2.13 Wild swimming

- The following data is recorded during this activity:
 - Duration
 - Calorie consumption
 - Number of arm strokes

7.5.2.14 Rowing machine

- The following data is recorded during this activity:
 - Duration
 - Heart rate
 - Calorie consumption
- During this activity, you can also control the music on your smartphone by swiping all the way to the right.

7.5.2.15 Cross-trainer

- The following data is recorded during this activity:
 - Duration
 - Heart rate
 - Calorie consumption
- During this activity, you can also control the music on your smartphone by swiping all the way to the right.

7.5.2.16 Dancing

- The following data is recorded during this activity:
 - Duration
 - Heart rate
 - Calorie consumption
 - Steps
- You can access the individual data during the activity by swiping left and right on the screen. During this activity, you can also control the music on your smartphone by swiping all the way to the right.

7.5.2.17 Pilates

- The following data is recorded during this activity:
 - Duration
 - Heart rate
 - Calorie consumption
- During this activity, you can also control the music on your smartphone by swiping all the way to the right.



7.5.3 Exercise record

- By tapping the **[EXERCISE RECORD **] symbol, you get an overview of the latest recorded activities. If you swipe down, you will access the individual activities, which are highlighted with the date and time.
- To see more details of a saved activity, tap the respective activity several times. Here you can see the most important data about your activity.

7.5.4 Heart rate

- By tapping the **[HEART RATE **] symbol, you start the manual measurement of your heart rate.
- At the top right of the screen you can see your resting heart rate, which is calculated by the measured values of the respective day.
- The graph below shows the highest and lowest automatic heart rate readings for specific time intervals throughout the day and the highest and lowest readings for the day.

7.5.5 Stress

- By tapping the **[STRESS **] symbol, you get an overview of the measured stress level of the current day. The stress level is measured on a scale from 0 (no stress) to 99 (extreme stress). A smiley above the graphic indicates the current state of the stress level.



7.5.6 Sleep

- Tapping the **[SLEEP **] symbol takes you to sleep measurement. The following data is recorded: Duration of deep sleep phases, duration of light sleep phases, duration of waking time, time to fall asleep, time of getting up. Your smart watch automatically detects when you are sleeping and then starts the measurement.

7.5.7 Blood oxygen

- By tapping the **[BLOOD OXYGEN **] symbol, you start the manual measurement of your blood oxygen level. The graphic then shows the current blood oxygen level. The value updates in real time as long as you continue to use the function.

7.5.8 Breath training





- Tapping the **[BREATH TRAINING **] symbol takes you to breath training. Here you can carry out relaxation training with guided breathing.
- Select the rhythm (slow, normal, fast) and the duration (1 - 5 min.) of the breath training.
- Please tap the **[**] symbol to start the breath training. Then following the instructions on the display.
- If you want to end the breath training prematurely, press the side control button **[1]** and confirm the subsequent question.
- After completing the breath training, a score is displayed.

7.5.9 Music





- By tapping the **[MUSIC **] symbol, the control view for various music or streaming services opens. These can be controlled directly via your watch. You can start or stop music and skip tracks forward or backward.
- The music control must be enabled in advance in the app (see Section **8.3.6.5 Music control**).



7.5.10 Timer

- To start the timer, first select the duration (1, 3, 5, 10, 30, 60 min.) by swiping.
- To start the timer, please tap the  symbol. To pause the timer, please tap the  symbol. To save a split time, please tap the  symbol. To stop the measurement, please tap the  symbol.

7.5.11 Stopwatch

- To start the stopwatch, please tap the  symbol. To pause the stopwatch, please tap the  symbol. To save a split time, please tap the  symbol. To stop the measurement, please tap the  symbol.

7.5.12 Alarm clock

- Tapping the **[ALARM CLOCK]**  symbol allows you to set an alarm time. By tapping on the respective times, you can activate or deactivate the alarm clock or reminder.
- You can also set and manage the alarm or reminder times in the app and synchronise them with your smart watch (see Section **8.3.4 Alarm clock**).

7.5.13 Weather

- By tapping on the **[WEATHER]**  symbol, you can see the weather forecast for the respective day with the current temperature as well as the low and high. Swipe up to see the weather forecast for the next two days.
- The weather data is transmitted and updated by synchronising your smart watch with the app. At the top of the weather display screen you can see the most recent update.
- The weather forecast must be enabled in advance in the app (see Section **8.3.6.7 Weather push**).











7.5.14 Telephone search

- By tapping the **[FIND PHONE]**  symbol, you can start the telephone search to find your mislaid smartphone. Your smartphone starts vibrating or you hear a loud signal tone.



7.5.15 Settings

By tapping the **[SETTINGS **] symbol, you access a sub-menu where you can make the following settings and turn off or reset your smart watch.

- By tapping the **[WAKE SCREEN **] symbol, you can enable or disable arm movement to switch on the display. When arm movement is activated, you can switch on the display by turning your wrist.
- By tapping the **[DO NOT DISTURB **] symbol, you can enable or disable Do Not Disturb mode. When Do Not Disturb mode is activated, no notifications are forwarded to your smart watch.
- By tapping **[WATCH FACE **], you can choose between four different home screens. Confirm your selection by tapping on the respective home screen.
- By tapping **[SCREEN SETTINGS **], you can set the brightness, the screen-on time and the automatic brightness control of the display.
You can adjust the brightness of the display in three steps [  ].
The screen-on time determines how long the display of your smart watch remains active after an operation. You can set the screen-on time between 5 - 20 sec. Note that a longer screen-on time has a negative effect on the battery life of your smart watch.
If you activate the automatic brightness control, your smart watch automatically adjusts the brightness of the display according to the ambient brightness.
- By tapping **[TURN OFF **] and confirming the subsequent question, you can turn off your smart watch.
- By tapping **[RESTART **] and confirming the subsequent question, you can restart your smart watch.
- By tapping **[RESET **] and confirming the subsequent question, you can restore your smart watch to the factory default settings. This deletes all recorded user data.
- By tapping **[ABOUT **], you will see the current firmware version, the MAC address and the model name of your smart watch. The MAC address makes your smart watch uniquely identifiable when you connect the device to your smartphone via Bluetooth.



8. Using the "Hama FIT move" app

The following sections explain the individual menu items and the various setting options within the app in more detail.

Note



- Please be aware that your terminal device must support some functions if they are to be used.
- Please refer to the operating instructions of your device for more information.

8.1 "Hama FIT move" overview

The start screen is the introduction to the "HamaFIT move" app.

The following overview explains the most important operating elements and views:

1. Display of health data
2. Display of steps
3. Display more cards
4. Menu bar





- On the home screen, please tap **[EDIT CARD]** at the very bottom to select the cards that will be displayed on the home screen. You can choose from a total of 8 cards. You can hide cards and move the order of the cards.
- The cards that are at the top of the list and marked with the **[−]** symbol are currently displayed on the home screen. The cards that are at the bottom of the list and marked with the **[+]** symbol are not displayed.
- By tapping **[−]** or **[+]**, you can remove or add a card.
- You can also change the order of the saved cards by holding down the **[≡]** symbol and moving the cards in question to the corresponding position.

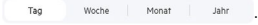

8.1.1 Health data

- On the home screen, please tap the first graphic at the top to see your health data.
- Here you can see an overview of the calories consumed, the activities carried out and the time period in which you exercised.
- By default, you will see the daily view of the health data. Select the period displayed in the top menu bar .
- To get more information, swipe upwards on your smartphone screen. Further down you will see detailed information on the categories Activity, Training and Walking.
- To open the detailed view of a recorded category, please tap the category in question. You will then see detailed data recorded on the category. For example, you can see the course of the route that was recorded via GPS as well as the duration, the distance covered, the calories burned or your pace.

 38/500 kcal
 0/30 MIN
 2/12 HRS

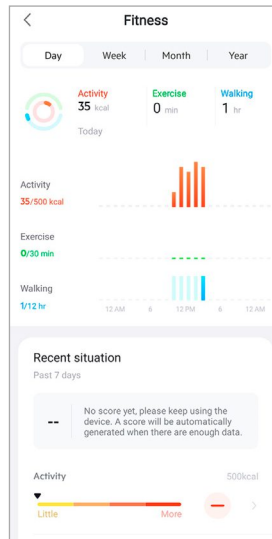



8.1.2 Step measurement

- On the home screen, please tap the second graphic at the top to see your recorded steps.
- Here you will see a summary of the steps you have taken that day.
- By default, you see the daily view of the step measurement. Select the period displayed in the top menu bar (Tag, Woche, Monat, Jahr). By swiping left and right on the chart for a longer time, you can switch back and forth between the individual days (or weeks/months/years). Your set steps goal is also displayed graphically in the diagram.
- Please tap  to make further settings (see Section 8.4.6 Settings).

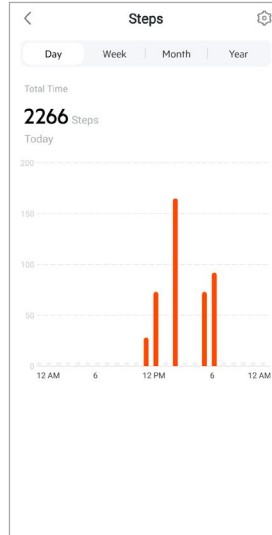
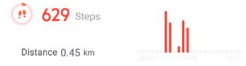



8.1.3 Training

Note



- Not all cards are displayed on the home screen by default. If necessary, fade in the desired card.
- Please tap the **[TRAINING]** card to get an overview of your training activities.
- Here you can see an overview of the activity sorted by days. The total time, the average weekly duration, the accumulated trainings and the calories burned are displayed.
- Please tap [∨] to expand the selected day and view the respective training activities. Please tap [∧] to collapse the day.
- To view the activities of a specific type of sport, please tap [≡].
- To open the detailed view of a recorded activity, tap the activity. You will then see detailed data recorded on the activity. For example, you can see the course of the route that was recorded via GPS as well as the duration of the activity, the steps taken and the distance covered, the calories burned or your pace. You also receive a detailed evaluation of your heart rate.

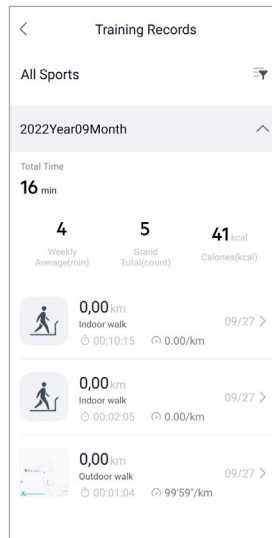



8.1.4 Sleep analysis

Note



- Not all cards are displayed on the home screen by default. If necessary, fade in the desired card.
- Please tap the **[SLEEP]** card to get an overview of your sleep analysis.
- Here you can see an overview of the total sleep time as well as the distribution of your sleep time into deep sleep, light sleep and waking phases. In the centre of the screen you can also see the start and end time of the sleep.
- By default, you will see the day view of the sleep analysis.
Select the period displayed in the top menu bar Tag Woche Monat Jahr . By swiping left and right on the chart for a longer time, you can switch back and forth between the individual days (or weeks/months/years). Here you can see an overview of your sleep patterns for a week, a month or a year. At the bottom of the screen you will see the following data related to a week, a month or a year:
 - Average duration of sleep per day
 - Average deep sleep phase on one day
 - Average light sleep on one day
 - Average onset of sleep phase
 - Average end of sleep phase
 - Average waking phase

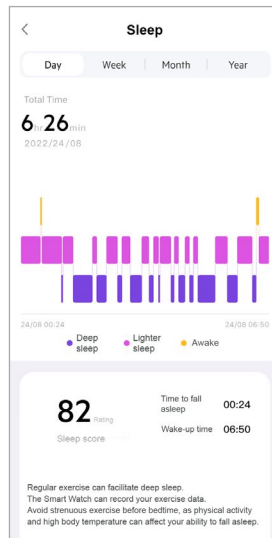



8.1.5 Heart rate measurement

Note



- Not all cards are displayed on the home screen by default. If necessary, fade in the desired card.
- Please tap the **[HEART RATE]** card to get an overview of your heart rate measurement.
- Here you can see all recorded values of the automatic heart rate measurement as well as an overview of your average heart rate, your heart rate zone and your resting heart rate for the respective day. By swiping gently to the left and right on the chart, you can call up the individual values with the respective time.
- By default, you will see the day view of the heart rate measurement. Select the period displayed in the top menu bar **Tag** **Woche** **Monat** **Jahr** . By swiping left and right on the chart for a longer time, you can switch back and forth between the individual days (or weeks/months/years).
- Please tap  to make further settings (see Section **8.3.5.1 Continuous heart rate measurement**).





8.1.6 Stress measurement

Note



- Not all cards are displayed on the home screen by default. If necessary, fade in the desired card.
- Tap the **[STRESS]** card to get an overview of your stress measurement.
- Here you can see all recorded values of the automatic stress measurement as well as an overview of your average stress level, your stress range and a graph of your stress zone for the respective day. By swiping gently to the left and right on the chart, you can call up the individual values with the respective time.
- By default, you will see the day view of the heart rate measurement. Select the period displayed in the top menu bar (Tag | Woche | Monat | Jahr). By swiping left and right on the chart for a longer time, you can switch back and forth between the individual days (or weeks/months/years).
- Please tap  to make further settings (see Section 8.3.5.2 Continuous stress measurement).

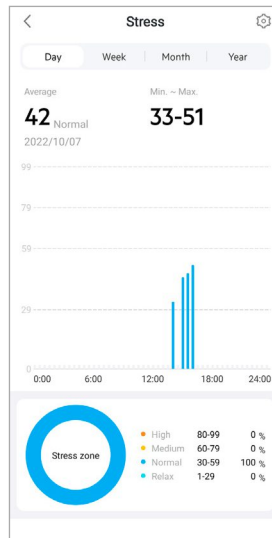



8.1.7 Blood oxygen

Note



- Not all cards are displayed on the home screen by default. If necessary, fade in the desired card.
- Please tap the **[SpO2]** card to get an overview of your blood oxygen measurements. You can perform the measurement manually via your smart watch (see Section **7.5.7 Blood oxygen**).
- Here you can see all recorded values of the blood oxygen measurements as well as an overview of your lowest and highest value for the respective day. By swiping gently to the left and right on the chart, you can call up the individual values with the respective time.
- By default, you will see the day view of the blood oxygen measurement. Select the period displayed in the top menu bar **Day** **Week** **Month** **Year**. By swiping left and right on the chart for a longer time, you can switch back and forth between the individual days (or weeks/months/years).

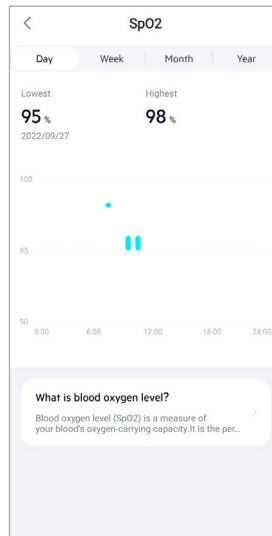



8.1.8 Weight recording

Note



- Not all cards are displayed on the home screen by default. If necessary, fade in the desired card.
- Please tap the **[WEIGHT]** card to get an overview of your weight record.
- Here you can see your weight history, your BMI and your set goal value.
- Please tap **[RECORD WEIGHT]** to enter your current weight.
- Please tap **[EDIT GOAL]** to edit your weight goal.
- By default, you will see the day view of the weight record.
Select the period displayed in the top menu bar **Day** | **Week** | **Month** | **Year** . By swiping left and right on the chart for a longer time, you can switch back and forth between the individual days (or weeks/months/years). The measured values are then also displayed as a progression curve.

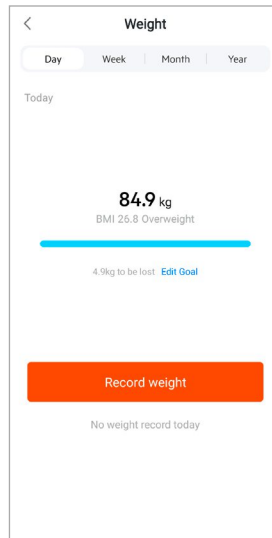



8.1.9 Menstruation cycle

Note



- Not all cards are displayed on the home screen by default. If necessary, fade in the desired card.
- Please tap the **[MENSTRUAL CYCLE]** card to get an overview of your menstrual cycle.
- Please tap **[ENTER MENSTRUATION DAYS]** to enter your current menstruation.

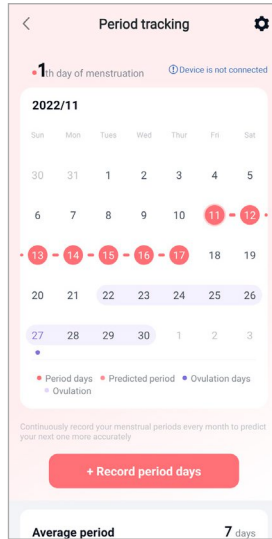



8.2 Activity mode

- Please tap **[TRAINING]** in the bottom menu bar to start an activity via the app. This starts the activity on your smart watch at the same time. The activity can then be controlled either via the app or directly on your smart watch.
- Swipe left and right to move back and forth between activities.
- By default, the following activities are enabled in the app:
 - Outdoor running
 - Indoor running
 - Outdoor walking
 - Indoor walking
 - Hiking
 - Outdoor cycling
- Please tap **[⋮]** at the top right and **[EDIT SPORTS MODE]** to select the activities that will be displayed. In total you can choose from 6 activities. You can hide activities and move the order of activities.
- The activities that are at the top of the list and marked with the **[⊖]** symbol are displayed. The activities that are at the bottom of the list and marked with the **[⊕]** symbol are not displayed.
- Tap **[⊖]** or **[⊕]** to remove or add an activity.
- You can also change the order of the activities by holding down the **[☰]** symbol and moving the respective activities to the appropriate position.
- Please tap **[⚙️]** to make the following settings:
 - Set a training goal (distances, calories, steps, duration)
 - Activate an alarm when reaching a goal (1, 3, 5, 10 km)
 - Set a heart rate zone and activate an alarm

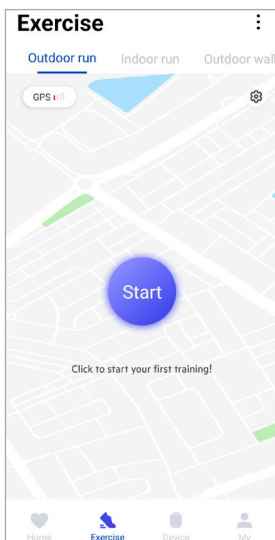







8.2.1 Start activity (with GPS)

- The following activities are recorded with GPS support:
 - Outdoor running
 - Outdoor walking
 - Hiking
 - Outdoor cycling
- To start an activity, please tap **[START]**. The activity now starts on the smartphone and on your smart watch.
- During the current activity, you can see the cumulative total kilometres covered so far for the selected activity, the current pace, the elapsed time and the current heart rate.

Operation with smartphone

- To display the map with your current position and distance travelled during an activity, please tap .
- To lock the overview of the recording during an activity, please tap .
- To pause the activity, please tap the  symbol.
- To end the activity, please tap the  symbol and keep your finger pressed until a circle closes around the symbol and the activity ends.

Operation with smart watch

- To pause the activity, press the side control button **[1]**.
- To end the activity, press the side control button **[1]** and then please tap the  symbol. Then follow the further instructions.

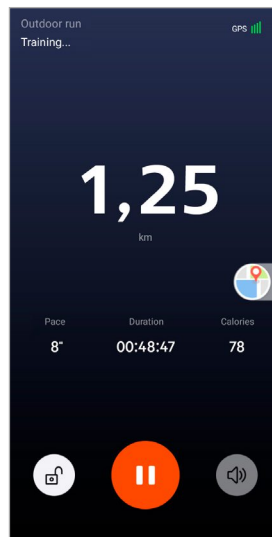



- When the activity is finished, an overview of the activity is displayed. In the overview you can see the cumulative total kilometres covered so far, the calories burned, the average heart rate and the duration of the activity. Below you will find more detailed information about the pace and steps. Swipe your finger from the bottom to the top to see details of the heart rate measurement and pace.
- You can print out the results of the activity or forward them as a screenshot.

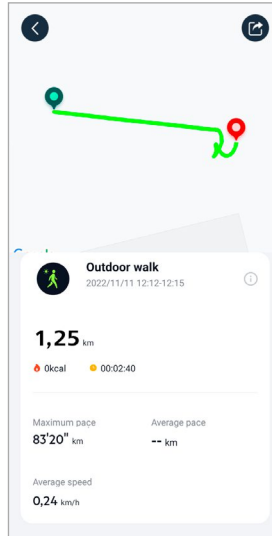



8.2.2 Start activity (without GPS)

- The following activities are recorded without GPS support:
 - Indoor running
 - Indoor walking
- To start an activity, please tap **[START]**. The activity now starts on the smartphone and on your smart watch.
- During the current activity, you can see the cumulative total kilometres covered so far for the selected activity, the current pace, the elapsed time and the current heart rate.

Operation with smartphone

- To lock the overview of the recording during an activity, please tap [🔒].
- To pause the activity, please tap the [⏸] symbol.
- To end the activity, please tap the [🔴] symbol and keep your finger pressed until a circle closes around the symbol and the activity ends.

Operation with smart watch

- To pause the activity, press the side control button [1].
- To end the activity, press the side control button [1] and then please tap the [🔴] symbol. Then follow the further instructions.

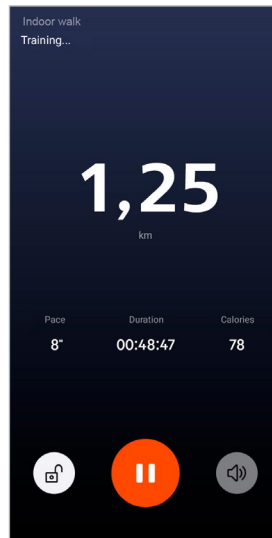



- When the activity is finished, an overview of the activity is displayed. In the overview you can see the cumulative total kilometres covered so far, the calories burned, the average heart rate and the duration of the activity. Below you will find more detailed information about the pace and steps. Swipe your finger from the bottom to the top to see details of the heart rate measurement and pace.
- You can print out the results of the activity or forward them as a screenshot.

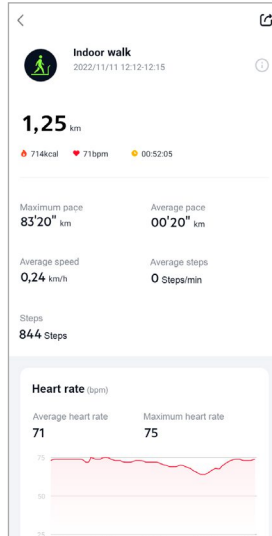



8.3 Device settings

- Please tap **[DEVICE]** in the lower menu bar to enable and set the various functions of your smart watch and to adjust your smart watch to your individual needs.
- In this menu, you will also see an overview of various items of data from your connected smart watch at the top of the screen. You can see when the smart watch was last synchronised with the app or to what percentage the smart watch's battery is currently charged.
- Please tap **[+]** to pair more devices with your smartphone.
- Please tap your device to get information about your smart watch or to access advanced features.
- Please tap **[DEVICE UPGRADES]** to check if the latest firmware version is installed on your smart watch or to download and install a new firmware version on your smart watch.
- Please tap **[RESTART THE DEVICE]** and confirm the subsequent question to restart your smart watch. Before restarting, your data will be synchronised with the app.
- Please tap **[DELETE DEVICE]** to cancel the pairing between your smart watch and your smartphone. All personal data will be deleted from your smart watch.

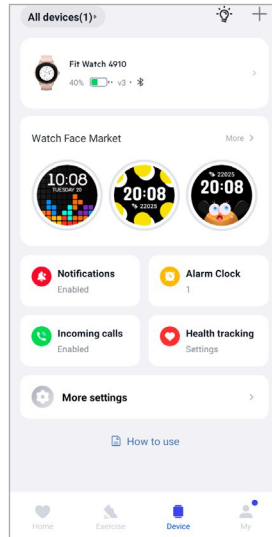



8.3.1 Home screen

- Please tap **[WATCH FACE MARKET]** to install additional watch faces for the home screen of your smart watch. Here you can choose between various watch faces. Please tap the respective watch face that you want to set and confirm the selection with **[INSTALL]**. If you have reached the maximum number of watch faces on the device, you will be prompted to delete existing watch faces.
- Alternatively, you can select an individual wallpaper as the home screen by tapping **[PHOTO]**. Please tap **[SELECT FROM ALBUM]** and select a photo from the smartphone gallery or tap **[TAKE A PHOTO]** to take a new photo. To confirm the change, please tap **[COMPLETE]**.

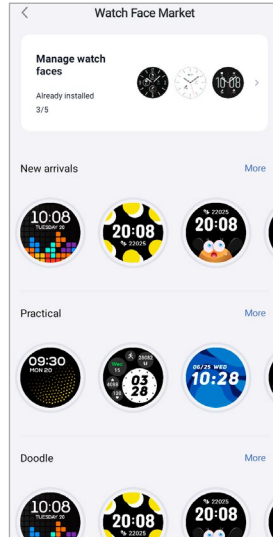

8.3.2 Notifications

- Please tap **[NOTIFICATIONS]** to enable the notification function for various apps and services. When this function is enabled, you will receive notification on your smart watch when a message comes in on your smartphone. Depending on the app, you will either only receive a notification with a display of the app in question and the sender or you will also see a preview of the message.
- Please tap **[**] on the side of the respective app to enable the notification function.

8.3.3 Incoming calls

- Please tap **[INCOMING CALLS]** to enable the incoming call notification. When this function is enabled, you will receive notification on your smart watch in the event of an incoming call. You can see who is calling, and you can reject the call if necessary.
- Please tap **[**] on the right edge of the screen to enable the function. You can then set whether the notification of the call should be delayed by 3 sec.



8.3.4 Alarm clock

- Tap **[ALARM]** to set alarm times or reminders.
- To add a new reminder, please tap **[+]** in the centre of the screen.
- Please tap **[☑]** on the right edge of the screen to enable the set alarm.
- You can edit the created reminder by tapping on it. In the sub-menu you can set the reminder type, the respective weekdays, the time for the reminder and other details.

8.3.5 Health monitoring

- Please tap **[HEALTH MONITORING]** to set functions that monitor your health and remind you to exercise and/or drink water.

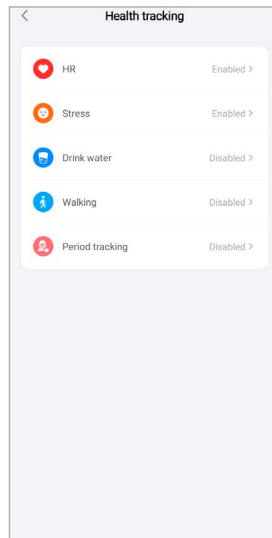

8.3.5.1 Continuous heart rate measurement

- Please tap **[HEART RATE]** to enable/disable this function in the sub-menu by tapping **[☑]**.
- Select the measurement frequency. With the "Real-time monitoring" option, your heart rate is measured permanently, in real time. Note that this causes increased power consumption. With the "Automatic measurement" option, your heart rate is measured every 5 minutes. Note that active training automatically measures in real time.



8.3.5.2 Continuous stress measurement

- Please tap **[STRESS]** to enable/disable the reminder function for too much stress in the sub-menu by tapping . Then set further settings for the reminder function. For more information, see the text below in the app.

8.3.5.3 Drinking reminder

- Please tap **[DRINK SOME WATER!]** to enable/disable this function in the sub-menu by tapping . Then set further settings for the reminder function. Your smart watch automatically reminds you to drink something at a set interval through vibration and notification.

8.3.5.4 Walking/walk around reminder

- Please tap **[WALK]** to enable/disable this function in the sub-menu by tapping . Then set further settings for the reminder function. You are automatically reminded by your smart watch to move at the set interval through vibration and notification. For more information, see the text below in the app.

8.3.5.5 Tracking the menstrual cycle

- Please tap **[TRACK MENSTRUATION]** to enable/disable this function in the sub-menu by tapping . By activating this function, you can set different dates related to your menstrual cycle and receive reminders about your next period or your fertile phase.
- You can then set the length of the menstrual period, the length of the menstrual cycle and the date of the last menstrual period via the sub-menus.
- Then please tap **[START TO USE]** to start tracking.



8.3.6 More settings

- Please tap **[MORE SETTINGS]** to make further settings and activate useful features.

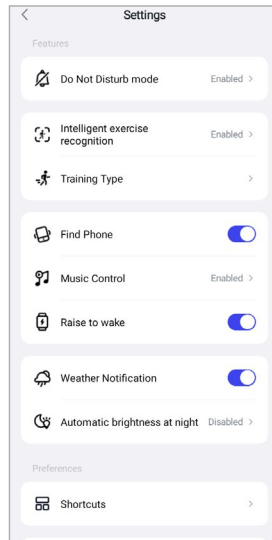

8.3.6.1 Do Not Disturb mode

- Please tap **[DO NOT DISTURB MODE]** to enable/disable this function in the sub-menu by tapping **[**]. When this function is enabled, you will not receive any notifications on your smart watch.
- You can additionally set the time period in which the mode should be active by tapping on the start and end time.

8.3.6.2 Automatic activity detection

- Please tap **[AUTOMATIC TRAINING TRACKING]** and enable/disable the function in the sub-menu for the two activities walking and running by tapping **[**]. When this function is enabled, your smart watch automatically detects when you engage in an activity (walking/running) for a longer period of time and records this activity after confirmation. For more information, see the text below in the app.



8.3.6.3 Type of training

- Please tap **[TYPE OF TRAINING]** to select the activities that will be stored on your smart watch. You can choose from various activities. You can hide activities and move the order of activities. By default, all activities are set. After the next synchronisation with your smart watch, the activities are shown in the display according to your settings.
- The activities that are at the top of the list and marked with the **[-]** symbol are currently displayed on your smart watch. The activities that are at the bottom of the list and marked with the **[+]** symbol are not displayed currently.
- Tap **[-]** or **[+]** to remove or add an activity.
- You can also change the order of the saved activities by holding down the **[≡]** symbol and moving the respective activity to the appropriate position.

8.3.6.4 Telephone search

- Please tap **[☑]** in **[FIND MY PHONE]** to enable this function. By enabling this function, you can find your mislaid smartphone again via the smart watch (see Section **7.5.14 Telephone search**).

8.3.6.5 Music control

- Please tap **[MUSIC CONTROL]** and enable/disable the function in the sub-menu by tapping **[☑]**. When this function is enabled, you can control various music or streaming services directly via your smart watch. You can start or stop music and skip tracks forward or backward.
- Please tap **[☑]** next to **[SONG'S TITLE]** to show the songs' titles on the display of your smart watch.

8.3.6.6 Arm movement activation

- Please tap **[☑]** next to **[RAISE YOUR WRIST TO TURN ON THE SCREEN]** to enable this function. By enabling this function, you can turn on the display of your smart watch by turning your wrist.

8.3.6.7 Weather push

- Please tap **[☑]** in **[WEATHER PUSH]** to enable this function. By enabling this function, you can see the weather forecasts for the current day and for the next two days on the smart watch (see Section **7.5.13 Weather**).

8.3.6.8 Automatic brightness at night

- Please tap **[AUTOMATIC BRIGHTNESS AT NIGHT]** and enable/disable the function in the sub-menu by tapping **[☑]**. Then set the time window in which the function is applied. By enabling this function, your smart watch automatically adjusts the display brightness based on the current ambient brightness.



8.3.6.9 Shortcuts

You can access the shortcuts via the display of your smart watch by swiping to the left or right from the home screen (see Section **7.4 Shortcuts**).

- Please tap **[SHORTCUTS]** to select the shortcuts that will be stored on your smart watch. You can choose from a total of 5 shortcuts. You can hide shortcuts and move the order of the shortcuts. By default, the daily views of the health data and the measurement of heart rate and stress are set. After the next synchronisation with your smart watch, the shortcuts are shown in the display according to your settings.
- The shortcuts that are at the top of the list and marked with the **[−]** symbol are currently displayed on your smart watch. The shortcuts that are at the bottom of the list and marked with the **[+]** symbol are currently not displayed.
- Tap **[−]** or **[+]** to remove or add shortcuts.
- You can also change the order of the saved shortcuts by holding down the **[≡]** symbol and moving the respective activity to the appropriate position.

8.3.6.10 Smart watch language setting

- Please tap **[DEVICE LANGUAGE]** to set the language on your smart watch.
- Select **[FOLLOW SYSTEM]** if the language on your smart watch is to be identical to the language of the app or smartphone.
- Alternatively, you can choose between eight languages and set them manually by tapping on the respective language.



8.4 User settings

- Please tap **[ME]** in the bottom menu bar. Here you can manage your user account and set your personal data and goals. You can also call up further information on the app, which is shown in the following sections.

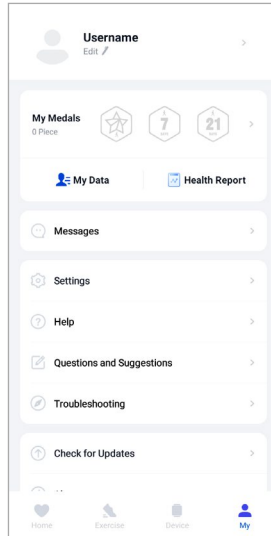

Note





- The prerequisite for this function is an active user account.



8.4.1 Personal details

- Please tap **[EDIT]** below your user name to edit your name, gender, date of birth and height and weight. If desired, you can also set a profile picture. Please tap the entry you want to edit.
- Please tap **[YES]** to confirm.

	
Username / 	
Gender	Male
Birthday	1984/03
Height	178cm
Weight	84,9kg
E-mail	dominik.franke@format-docu.de
Region	Germany



8.4.2 My medals

- Under **[MEDALS]** you can see your personal successes (medals). Please tap on an entry to get more information.

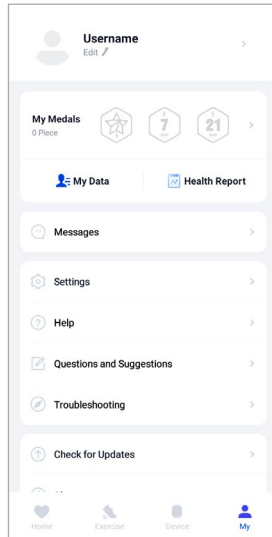

8.4.3 My data

- Under **[MY DATA]** you can see the record of all your measurements. Please tap on an entry to get more information.

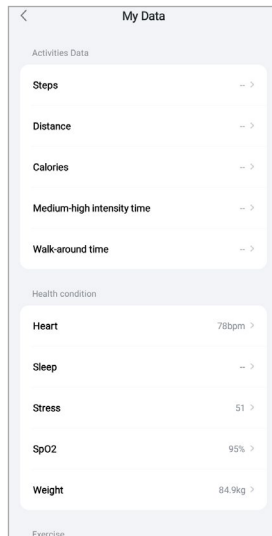



8.4.4 Health report

- Under **[HEALTH REPORT]** you can see the weekly record of all your health data and activities. Please tap on a corresponding weekly report to get detailed information.

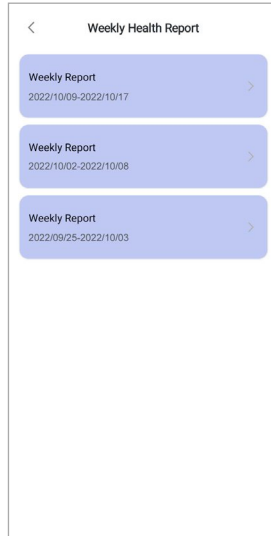

8.4.5 Messages

- Under **[MESSAGES]** you get an overview of news about the app, such as new features or updates.



8.4.6 Settings

- Under **[SETTINGS]**, you can make various settings and call up information. You can change your e-mail address and the password of your user account. You also have the option of logging out of your user account or cancelling the user account completely.
- Please tap **[MY GOALS]** to set personal goals for steps achieved and weight.
- Please tap **[MANUAL SYNC]** to manually start synchronising the data between your smart watch and the app.
- Please tap **[PREFERENCES]** to set the units for distance, weight and temperature. You can also define the time format and which day of the week is the first day of the week on which your data is prepared.
- Please tap **[CARD ENGINE]** to select the card used in the background for various measurements.
- Please tap **[PRIVACY AND SECURITY]** to set what data is synchronised from the app to the cloud. To delete all data, please tap **[CLEAR PERSONAL DATA ON THE CLOUD]**.
- Please tap **[DATA SHARING AND AUTHORIZATION]** to allow the recorded data to be shared with other apps. Only apps that are installed on your smartphone and support this function are displayed.
- Please tap **[MODIFY EMAIL]** to change the e-mail address of your user account.
- Please tap **[CHANGE PASSWORD]** to change the password of your user account.
- Please tap **[CLEAR CACHE]** to delete the temporary data from the app. No recorded data is lost in the process.
- Please tap **[LOG OUT]** to log out the current user account.
- Please tap **[CANCEL ACCOUNT]** and confirm the following prompt to cancel your user account. All settings and recorded data will be lost.

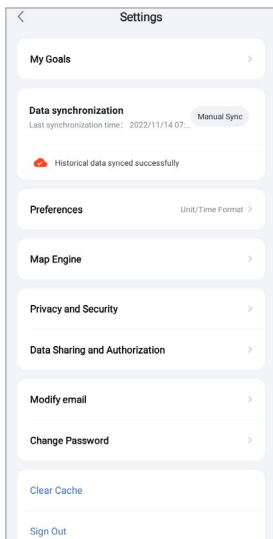



8.4.7 Help

- Please tap **[HELP]** to get an overview of answers to FAQs. Please tap on the respective question to get more information.
- If your question is not answered, check the information in the Troubleshooting section (see Section **8.4.9 Troubleshooting**) or send an enquiry to the Hama product advisory service (see Section **8.4.8 Questions and suggestions**).

8.4.8 Questions and suggestions

- Please tap **[QUESTIONS AND SUGGESTIONS]** to send an enquiry or feedback to the Hama product advisory service.
- Select a subject area and then describe your enquiry in more detail. You can also add images to your request and share the log of the connections between the smart watch and the app. Please always quote your e-mail address with every enquiry.
- Please tap **[SUBMIT]** at the top right to send an enquiry.

8.4.9 Troubleshooting

- Please tap **[TROUBLESHOOTING]** to get an overview of answers to FAQs. Please tap on the respective question to get more information.
- If your question is not answered, please send an enquiry to the Hama product advisory service (see Section **8.4.8 Questions and suggestions**).

8.4.10 Check for updates

- Please tap **[CHECK FOR UPDATES]** to check for a newer version of the "HamaFIT move" app. You will be automatically redirected to Google Play (Android) or the App Store (Apple).

Note



- In the default settings of your smartphone, you should be automatically informed about app updates.

8.4.11 About

- Under **[ABOUT]** you can get information about the app such as the app version used, the privacy policy and the user agreement.
- Please tap **[WITHDRAW CONSENT]** if you wish to withdraw consent to the privacy policy and user agreements. Please note that it is not possible to use the app without these consents.



9. Care and maintenance

- Only clean this product using a lint-free, slightly damp cloth and do not use any harsh cleaners.
- Ensure that no water is able to enter the product.

10. Warranty disclaimer

Hama GmbH & Co KG assumes no liability and provides no warranty for damage resulting from improper installation/mounting, improper use of the product or from failure to observe the use instructions and/or safety notes.

11. Technical data

Bluetooth version	5.1
Screen type	LCD full-touch
Display size	1.09"
Dimensions	231 × 45 × 13 mm
Weight	34g
Strap lengths	10.6cm / 8.4cm
Strap width	20 mm
Strap width clasp	23 mm
Strap material	Silicon
Housing material	Aluminium alloy / polycarbonate (PC)
Protection class	IP68
Battery type	Lithium polymer
Battery capacity	210 mAh / 3.9V
Charging time	Approx. 1.5 hours
Battery life	144 hours

12. Disposal instructions

Note on environmental protection:



Following the implementation of European Directives 2012/19/EU and 2006/66/EU into the national legal systems, the following applies: Electrical and electronic devices as well as batteries must not be disposed of with household waste. Consumers are obliged by law to return electrical and electronic devices as well as batteries to the designated public collection points or to the point of sale at the end of their service life. Detailed information on this topic is defined in the national laws of the respective country. This presence of the above symbol on the product, operating instructions or package indicates that the product is subject to these regulations. By recycling, reusing the materials or other forms of utilising old devices/batteries, you are making an important contribution to protecting our environment.

13. Declaration of conformity

CE Hama GmbH & Co KG hereby declares that this device is in compliance with the essential requirements and other relevant provisions of Directive 2014/53/EU. The declaration of conformity in accordance with the relevant directive can be found at www.hama.com.

Frequency band(s)	2402 – 2480 MHz
Maximum radio-frequency power transmitted	4 dBm

hama

Hama GmbH & Co KG
86652 Monheim / Germany

Service & Support

 www.hama.com

 +49 9091 502-0

D

The Bluetooth® word mark and logos are registered trademarks owned by Bluetooth SIG, Inc. and any use of such marks by Hama GmbH & Co KG is under licence. Other trademarks and trade names are those of their respective owners.

All listed brands are trademarks of the corresponding companies. Errors and omissions excepted, and subject to technical changes. Our general terms of delivery and payment are applied.

Ovaj dokument je originalno proizveden i objavljen od strane proizvođača, brenda Hama, i preuzet je sa njihove zvanične stranice. S obzirom na ovu činjenicu, Tehnoteka ističe da ne preuzima odgovornost za tačnost, celovitost ili pouzdanost informacija, podataka, mišljenja, saveta ili izjava sadržanih u ovom dokumentu.

Napominjemo da Tehnoteka nema ovlašćenje da izvrši bilo kakve izmene ili dopune na ovom dokumentu, stoga nismo odgovorni za eventualne greške, propuste ili netačnosti koje se mogu naći unutar njega. Tehnoteka ne odgovara za štetu nanесenu korisnicima pri upotrebi netačnih podataka. Ukoliko imate dodatna pitanja o proizvodu, ljubazno vas molimo da kontaktirate direktno proizvođača kako biste dobili sve detaljne informacije.

Za najnovije informacije o ceni, dostupnim akcijama i tehničkim karakteristikama proizvoda koji se pominje u ovom dokumentu, molimo posetite našu stranicu klikom na sledeći link:

<https://tehnoteka.rs/p/hama-fit-watch-4910-roze-pametni-sat-akcija-cena/>