

Uputstvo za upotrebu (EN)

Be Quiet Dark Rock BK021 kuler za procesor

be quiet![®]



Tehnoteka je online destinacija za upoređivanje cena i karakteristika bele tehnike, potrošačke elektronike i IT uređaja kod trgovinskih lanaca i internet prodavnica u Srbiji. Naša stranica vam omogućava da istražite najnovije informacije, detaljne karakteristike i konkurentne cene proizvoda.

Posetite nas i uživajte u ekskluzivnom iskustvu pametne kupovine klikom na link:

<https://tehnoteka.rs/p/be-quiet-dark-rock-bk021-kuler-za-procesor-akcija-cena/>



DARK ROCK 4

be quiet!®

Introduction: Thank you for deciding to purchase a be quiet! product. The following instructions will guide you through the installation process. If you do encounter installation problems, please don't hesitate to contact our customer services by mailing service@bequiet.com. Please note that be quiet! cannot accept liability for damage caused by compatibility problems.

Warranty:

- 3 years manufacturer guarantee for consumers (original purchase from authorized be quiet! dealers only)
- Guarantee work can only be processed with an included copy of the purchase receipt from an authorized be quiet! dealer
- Manipulation and structural changes of any kind as well as damages through external mechanical forces lead to a complete voiding of the guarantee
- Our General Warranty Conditions apply, which can be viewed on bequiet.com

Listan GmbH · Wilhelm-Bergner-Straße 11c · 21509 Glinde Germany

For further information contact us via e-mail: service@bequiet.com

V1/23



www.bequiet.com/bk021

- EN » Product information for this CPU cooler
- DE » Produktinformationen zu diesem CPU-Kühler
- FR » Informations produit pour ce système de refroidissement
- ES » Información del producto para este refrigerador de CPU
- PL » Informacje produktowe dla tego coolera CPU
- NL » Engelstalige productinformatie voor deze processorkoeler
- SE » Produktinformation för den här processorkylaren, på engelska
- RU » Подробная информация о данном кулере для процессора
- TW » 此CPU散熱器的產品資訊
- CN » 此CPU散熱器的产品信息
- JP » 製品情報 (クーラー)

SCOPE OF DELIVERY

	Part name	Quantity
①	be quiet! Dark Rock 4 cooler	1
②	135mm fan	1
③	Intel backplate	1
④	Intel mounting brackets	2
⑤	Long AMD mounting brackets	2
⑥	Intel mounting brackets LGA 1700	2
⑦	Cooler mounting bridge	1
⑧	Intel spacer nut A	4

	Part name	Quantity
⑨	Intel spacer nut B	4
⑩	AMD spacer nuts	4
⑪	Mounting bracket fastening screws	4
⑫	Mounting bridge fastening screws	2
⑬	Intel backplate screws	4
⑭	AMD backplate screws	4
⑮	O-rings	4
⑯	Cross-tip screwdriver	1
⑰	Thermal paste	1
⑱	Fan clips	4

Intel: LGA 2011 (-3) square ILM / LGA 2066

General

We recommend preparatory mounting of the cooler outside the PC case for subsequent installation.

The following parts are needed for this:

1x Dark Rock 4 CPU cooler (1), 1x 135mm fan (2), 2x Intel mounting brackets (4), 1x cooler mounting bridge (7), 4x Intel spacer nut A (8), 4x mounting bracket fastening screws (11), 2x Mounting bridge fastening screws (12), 1x cross-tip screwdriver (16) 1x thermal paste (17), 2x fan clips (18)

2011(-3) square ILM, 2066

Position the cooler mounting bridge centrally on the cooler. Next place the cooler unit onto the CPU. Insert the mounting bridge fastening screws from above into the cooler mounting bridge and then screw these alternately tight. You can use the cross-tip screwdriver for this.

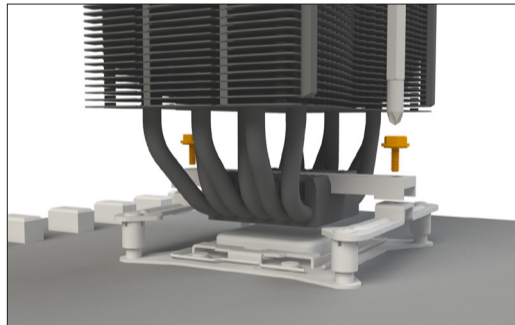

Fasten the 135mm fan onto the cooler unit using fan clips. Connect the fan to the motherboard's PWM signal.

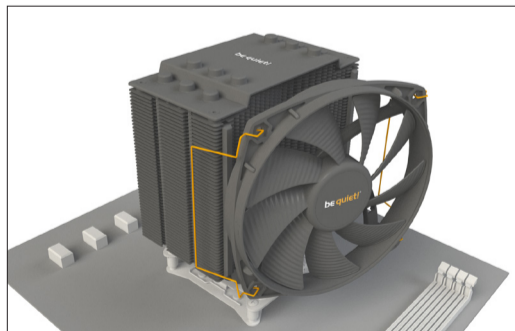

When dismantling the 135mm fan, push the notches of the fan clips away from the fan.

Intel: LGA 1200 / 1150 / 1151 / 1155

General

We recommend preparatory mounting of the cooler outside the PC case for subsequent installation.

The following parts are needed for this:

1x Dark Rock 4 CPU cooler (1), 1x 135mm fan (2), 1x Intel backplate (3), 2x Intel mounting brackets (4), 1x cooler mounting bridge (7), 4x Intel spacer nut B (9), 4x mounting bracket fastening screws (11), 2x mounting bridge fastening screws (12), 4x Intel backplate screws (13), 4x O-rings (15), 1x cross-tip screwdriver (16), 1x thermal paste (17), 2x fan clips (18)

Mounting the backplate

Position the Intel backplate screws in the notches situated on the rear side of the Intel backplate. Pay attention in so doing to align with the holes drilled for each socket.

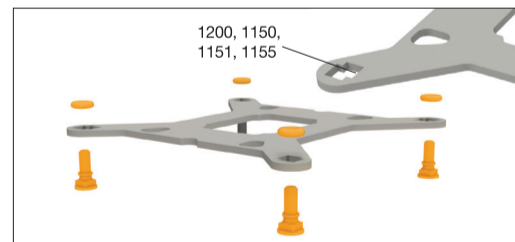

For fixing the backplate screws onto the Intel backplate use the O-rings. Once assembly of the Intel backplate for the respective Intel socket is complete, position it under the motherboard. Make sure that the backplate screws are precisely positioned inside the motherboard holes.

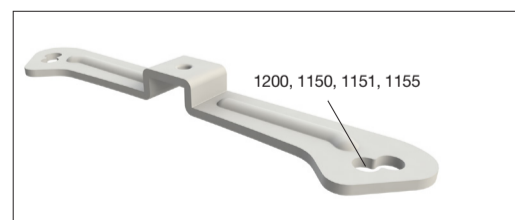

Installation of the mounting brackets

Screw the Intel spacer nut B onto the previously positioned Intel backplate. Then position the Intel mounting brackets over the Intel spacer nut B and affix these with the mounting bracket fastening screws. You can use the cross-tip screwdriver for this.

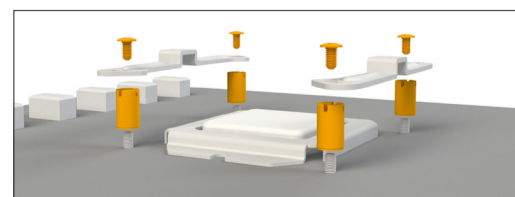

Mounting the CPU cooler

First remove the protective foil from the underside of the cooler. Spread the thermal paste on the surface of the CPU. The amount supplied is sufficient for one or two applications.

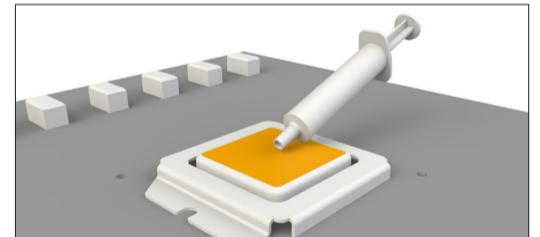

Caution: The thermal paste supplied is not suitable for human consumption. If swallowed, drink lots of water and urgently seek medical attention. Keep it out of the reach of children. Avoid contact with skin and eyes.

Position the cooler mounting bridge centrally on the cooler. Next place the cooler unit onto the CPU. Insert the Intel/ mounting bridge fastening screws from above into the cooler mounting bridge and then screw these alternately tight. You can use the cross-tip screwdriver for this.

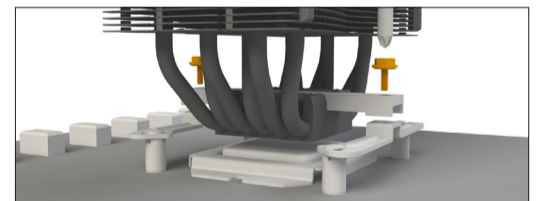

Mount the 135mm fan onto the cooler unit using the fan clips. Connect the fan to the motherboard's PWM signal.

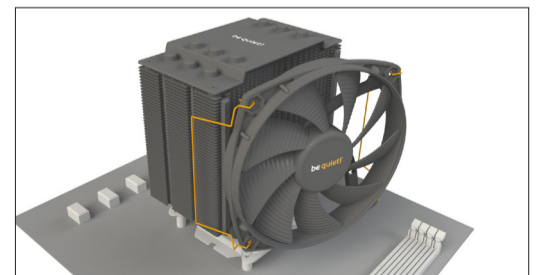

When dismantling the 135mm fan push the notches of the fan clips away from the fan.

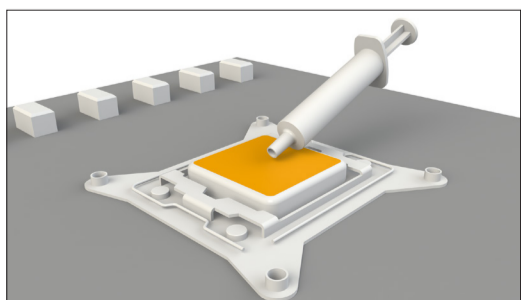

General

We recommend preparatory mounting of the cooler outside the PC case for subsequent installation.

The following parts are needed for this:

1x Dark Rock 4 CPU cooler (1), 1x 135mm fan (2), 1x Intel backplate (3), 2x Intel mounting brackets LGA 1700 (6), 1x cooler mounting bridge (7), 4x Intel spacer nut B (9), 4x mounting bracket fastening screws (11), 2x mounting bridge fastening screws (12), 4x Intel backplate screws (13), 4x O-rings (15), 1x cross-tip screwdriver (16), 1x thermal paste (17), 4x fan clips (18)

Mounting the backplate

Position the Intel backplate screws in the notches situated on the rear side of the Intel backplate. Pay attention in so doing to align with the holes specially drilled for each socket.

For fixing the backplate screws onto the Intel backplate use the O-rings. Once assembly of the Intel backplate for the respective Intel socket has been completed, position it under the motherboard. In so doing make sure that the Intel backplate screws are precisely located within the motherboard holes.

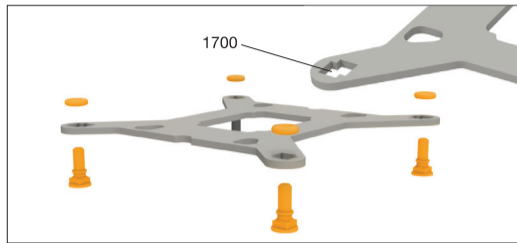
**Installation of the mounting brackets**

Screw the Intel spacer nut B onto the previously positioned Intel backplate. Then position the Intel mounting brackets LGA 1700 over the Intel spacer nut B and affix these with the mounting bracket fastening screws. You can use the cross-tip screwdriver for this.

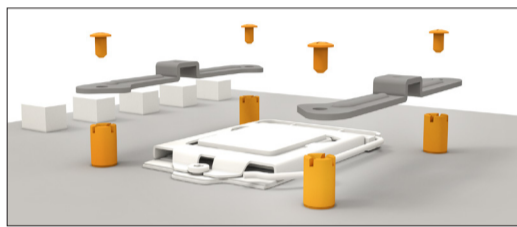

First remove the protective foil from the underside of the cooler. Spread the thermal paste on the surface of the CPU. The amount supplied is sufficient for one or two applications.

Caution: The thermal paste supplied is not suitable for human consumption. If swallowed, drink lots of water and urgently seek medical attention. Keep it out of the reach of children. Avoid contact with skin and eyes.

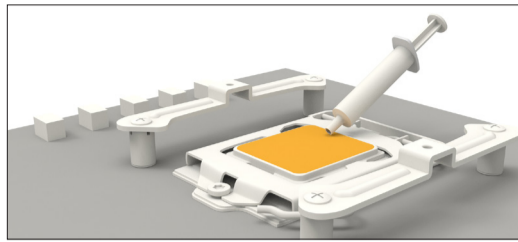

Position the cooler mounting bridge centrally on the cooler. Next place the cooler unit onto the CPU. Insert the mounting bridge fastening screws from above into the cooler mounting bridge and then screw these alternately tight.

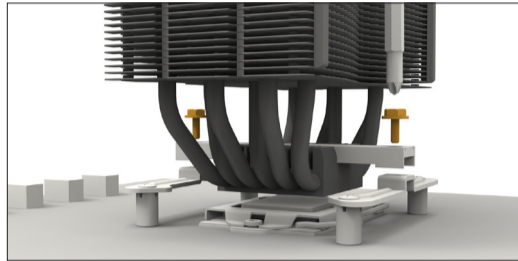

Mount the 135mm fan onto the cooler unit using the fan clips. Connect the fan to the motherboard's PWM signal.

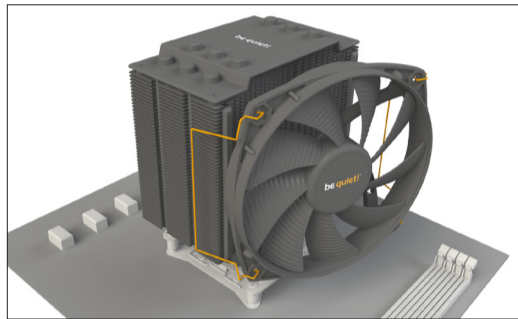

When dismantling the 135mm fan push the notches of the fan clips away from the fan.

General

We recommend preparatory mounting of the cooler outside the PC case for subsequent installation.

The following parts are needed for this:

1x Dark Rock 4 CPU cooler (1), 1x 135mm fan (2), 2x long AMD mounting brackets (5) 1x cooler mounting bridge (7), 4x AMD spacer nuts (10), 2x mounting bridge fastening screws (12), 4x AMD backplate screws (14), 1x cross-tip screwdriver (16), 1x thermal paste (17), 2x fan clips (18)

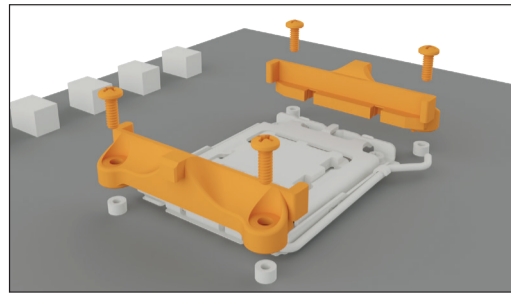
**Assembly of the cooler mounting frame**

To permit mounting of the cooler please remove both the plastic retainers of the AMD retention module. The factory-fitted backplate affixed to the rear side of the motherboard will be needed for subsequent installation of the cooler.

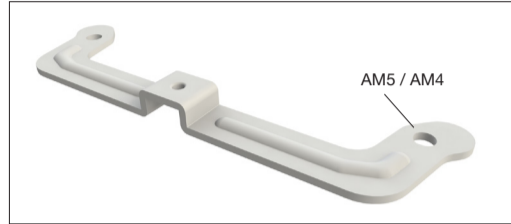

Place the four AMD spacer nuts onto the backplate bolts protruding through the front side and affix both long AMD mounting brackets with the AMD backplate screws.

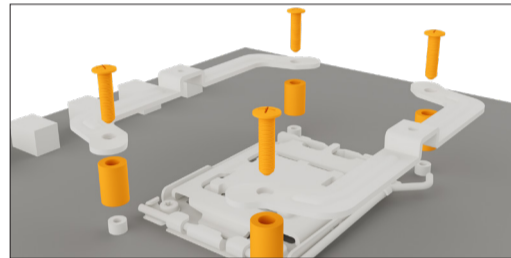
**Mounting the CPU cooler**

First remove the protective foil from the underside of the cooler. Spread the thermal paste on the surface of the CPU. The amount supplied is sufficient for one or two applications.

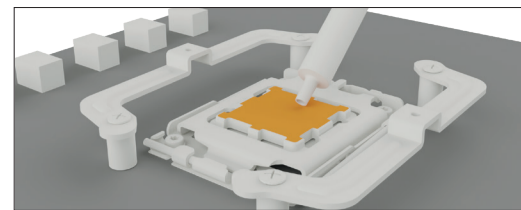

Caution: The thermal paste supplied is not suitable for human consumption. If swallowed, drink lots of water and urgently seek medical attention. Keep it out of the reach of children. Avoid contact with skin and eyes.

Position the cooler mounting bridge centrally on the cooler. Next place the cooler unit onto the CPU. Insert the mounting bridge fastening screws from above into the cooler mounting bridge and then screw these alternately tight. You can use the cross-tip screwdriver for this.

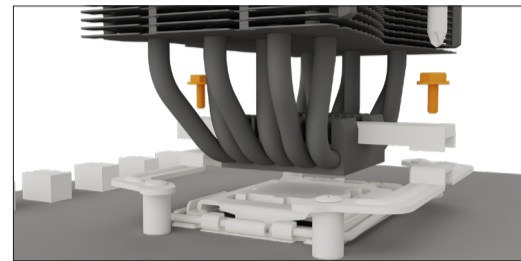

Mount the 135mm fan onto the cooler unit using the fan clips. Connect the fan to the motherboard's PWM signal.

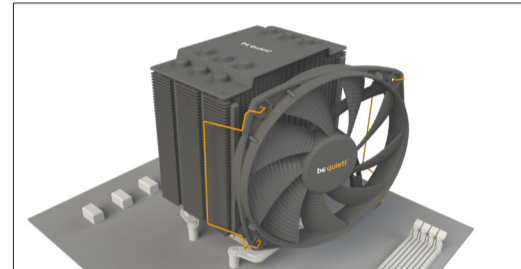

When dismantling the 135mm fan, push the notches of the fan clips away from the fan.

Limited Warranty

Per the terms and conditions of this limited warranty as given below, be quiet! warrants its new products to be free of defects resulting from faulty materials and faulty manufacturing for the length of the warranty period.

I. APPLICABILITY

This non-transferable warranty is applicable to newly purchased, previously unopened be quiet! products and is enforceable by only the original consumer purchaser. Proof of purchase is required for warranty service, so should be retained. be quiet! does not provide warranty registration services.

II. WARRANTY PERIOD

For eligible products, parts and labor are warranted for the applicable warranty period from the date of purchase. The applicable warranty period varies by product model, and is identified in your user documentation, on the product package, or as listed below. Should any of these warranty periods differ, the longest specified warranty period will apply. Replaced products will be warranted for the remainder of the original warranty period or thirty days, whichever is longer.

III. EXCLUSIONS

The following are not covered by the warranty:

- Normal wear and tear.
- Any product which has been modified without permission from be quiet!, or on which the serial number or warranty sticker has been defaced, modified, or removed.
- Damage, deterioration or malfunction resulting from: Accident, abuse, misuse or improper use, neglect, connection to an improper voltage source, unauthorized product modification, or failure to follow instructions included with the product.
Fire, water, lightning, or other acts of nature.
Repair or attempted repair by anyone not authorized by be quiet!.
Shipping or transport damage (claims must be made with the carrier).
Any other cause which does not relate to a defect in materials or manufacturing workmanship.
- Cartons, cases, batteries, cabinets, tapes, accessories or other consumables used with this product.

5. be quiet!, Inc. does not warrant that this product will meet your requirements. It is your responsibility to determine the suitability of this product for your purpose.

6. Removal or installation charges.

7. Shipping charges.

8. Any incidental charges.

IV. EXCLUSION OF DAMAGES

be quiet!'s sole obligation and liability under this warranty is limited to the repair or replacement of a defective product at its option. be quiet! shall not, in any event, be liable for any special, incidental, indirect, or consequential damages whatsoever, including but not limited to loss of profits, revenue, or data (whether direct or indirect), damages resulting from interruption of service and loss of business, or for liability in tort relating to this product or resulting from its use or possession, even if be quiet! has been advised previously of the possibility of such damages.

V. LIMITATIONS OF IMPLIED WARRANTIES

There are no other warranties, expressed or implied, including but not limited to those of merchantability or fitness for a particular purpose. The duration of implied warranties is limited to the warranty length specified in Paragraph II.50

VI. LOCAL LAW AND YOUR WARRANTY

This warranty gives you specific legal rights. You may also have other rights granted under local law. These rights may vary.

VII. NO OTHER WARRANTY

No be quiet! employee, dealer, or other agent is authorized to make any modification, extension, or addition to this warranty.

VIII. TO OBTAIN TECHNICAL SUPPORT OR WARRANTY SERVICE

Please see your product owner's manual or visit the Online Support section at www.bequiet.com for details and contact information. You will need to provide proof of purchase for warranty service.

**Notes**

Ovaj dokument je originalno proizveden i objavljen od strane proizvođača, brenda Be quiet!, i preuzet je sa njihove zvanične stranice. S obzirom na ovu činjenicu, Tehnoteka ističe da ne preuzima odgovornost za tačnost, celovitost ili pouzdanost informacija, podataka, mišljenja, saveta ili izjava sadržanih u ovom dokumentu.

Napominjemo da Tehnoteka nema ovlašćenje da izvrši bilo kakve izmene ili dopune na ovom dokumentu, stoga nismo odgovorni za eventualne greške, propuste ili netačnosti koje se mogu naći unutar njega. Tehnoteka ne odgovara za štetu nanесenu korisnicima pri upotrebi netačnih podataka. Ukoliko imate dodatna pitanja o proizvodu, ljubazno vas molimo da kontaktirate direktno proizvođača kako biste dobili sve detaljne informacije.

Za najnovije informacije o ceni, dostupnim akcijama i tehničkim karakteristikama proizvoda koji se pominje u ovom dokumentu, molimo posetite našu stranicu klikom na sledeći link:

<https://tehnoteka.rs/p/be-quiet-dark-rock-bk021-kuler-za-procesor-akcija-cena/>