

Uputstvo za upotrebu (EN)

LOGITECH slušalice G Pro X

logitech



Tehnoteka je online destinacija za upoređivanje cena i karakteristika bele tehnike, potrošačke elektronike i IT uređaja kod trgovinskih lanaca i internet prodavnica u Srbiji. Naša stranica vam omogućava da istražite najnovije informacije, detaljne karakteristike i konkurentne cene proizvoda.

Posetite nas i uživajte u ekskluzivnom iskustvu pametne kupovine klikom na link:

<https://tehnoteka.rs/p/logitech-slusalice-g-pro-x-akcija-cena/>

PRO X

SETUP GUIDE | GUIDE D'INSTALLATION



logitech ™

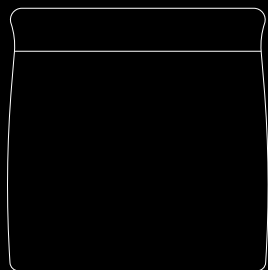
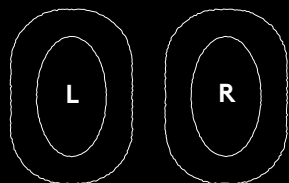
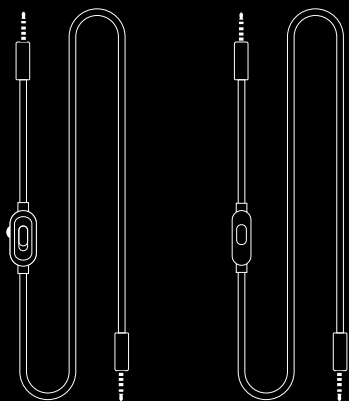

ENGLISH3
FRANÇAIS7
ESPAÑOL	11
PORTUGUÊS	15

PC SETUP

- 1 Plug in microphone
- 2 Plug console/PC cable into headset
- 3 Using USB DAC:
 - 1.Plug console/PC cable into USB DAC
 2. Plug USB DAC into PC¹
- 4 Using PC sound card:
 - 1.Plug console/PC cable into PC splitter
 2. Plug PC splitter into PC's headphone and mic ports

¹Included USB DAC enables 5-band EQ tuning, DTS Headphone:X 2.0 and Blue VO!CE microphone filters on PC. Requires Logitech G HUB software download. 5-band EQ tuning, DTS Headphone:X 2.0 and Blue VO!CE are not available while using PC sound card.

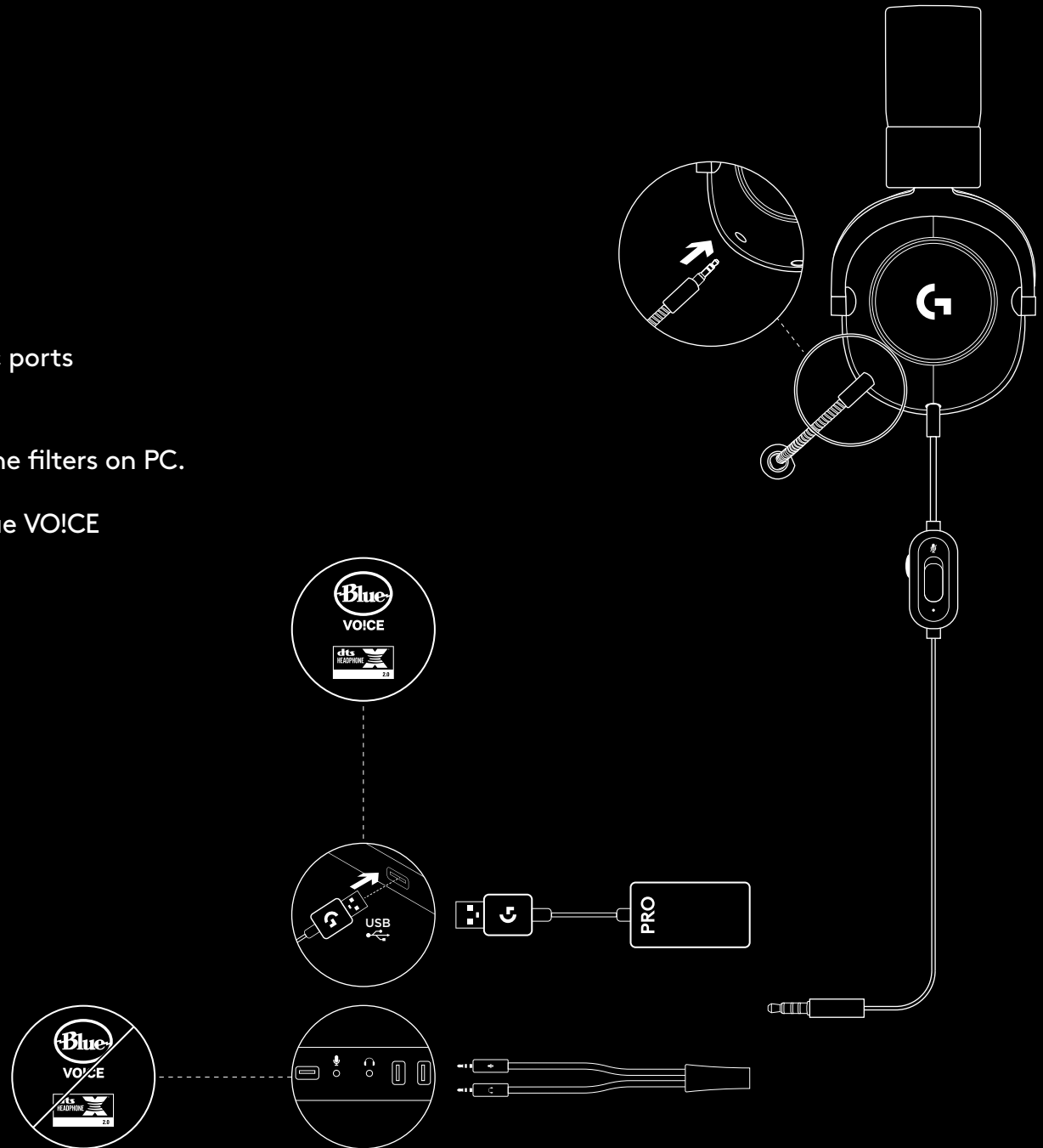

CONSOLE SETUP (XBOX ONE™, PLAYSTATION®4)

- 1 Plug in microphone
- 2 Plug console/PC cable into headset
- 3 Plug other end into controller²

² Instructions may vary based on your system version. Please check your console manual for additional guidance. Xbox One and PlayStation 4 operate in stereo mode only via analog cable. Some Xbox One controllers may require Xbox One Stereo Headset Adapter, sold separately. 5-band EQ tuning, DTS Headphone:X 2.0 and Blue VO!CE are not available while connected to console controller.

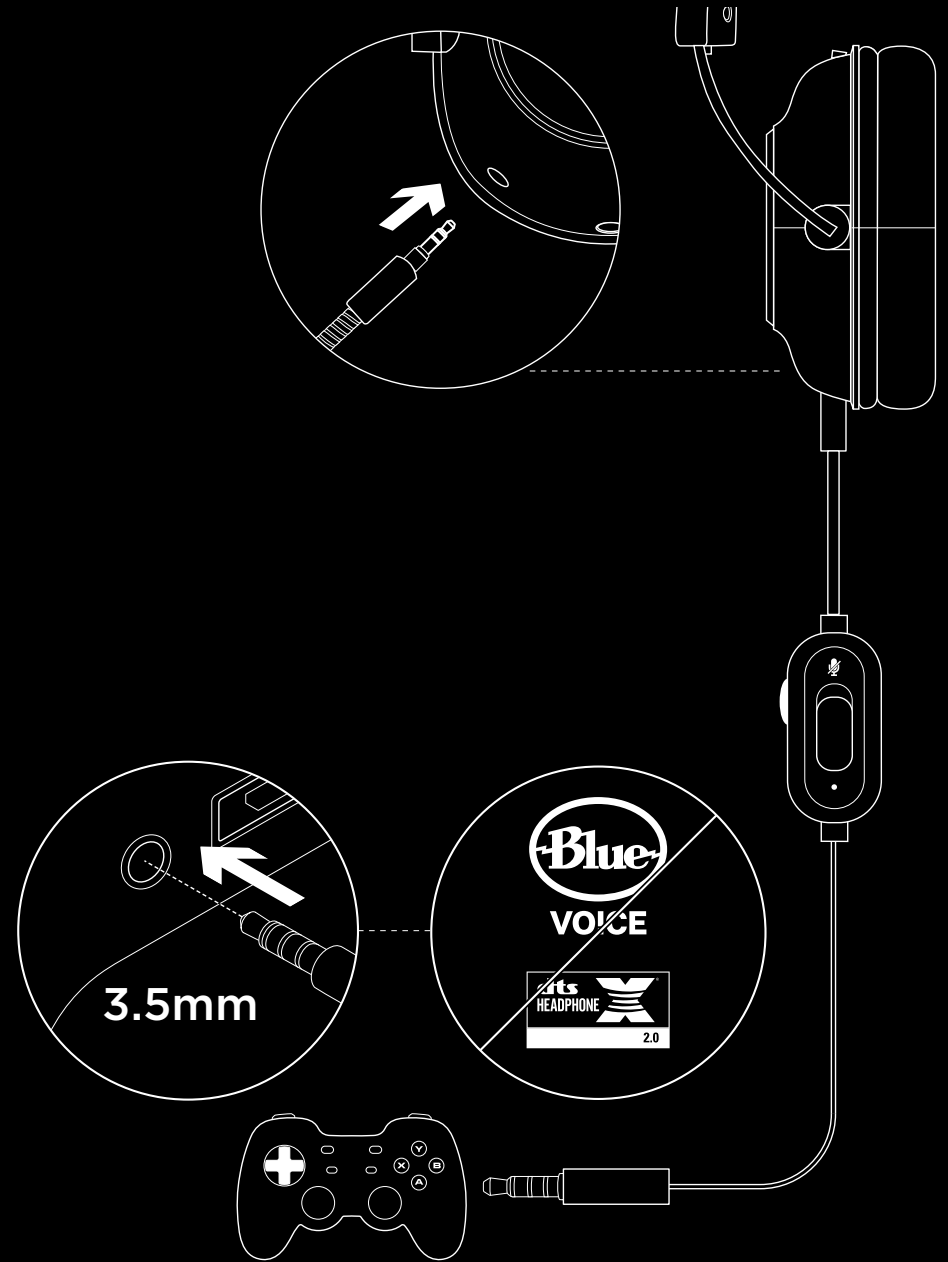

MICROPHONE POSITION SETUP

- 1 Remove microphone
- 2 Plug in mobile cable to headset
- 3 Plug mobile cable into phone³

³ 5-band EQ tuning, DTS Headphone:X 2.0 and Blue VO!CE are not available on mobile devices.

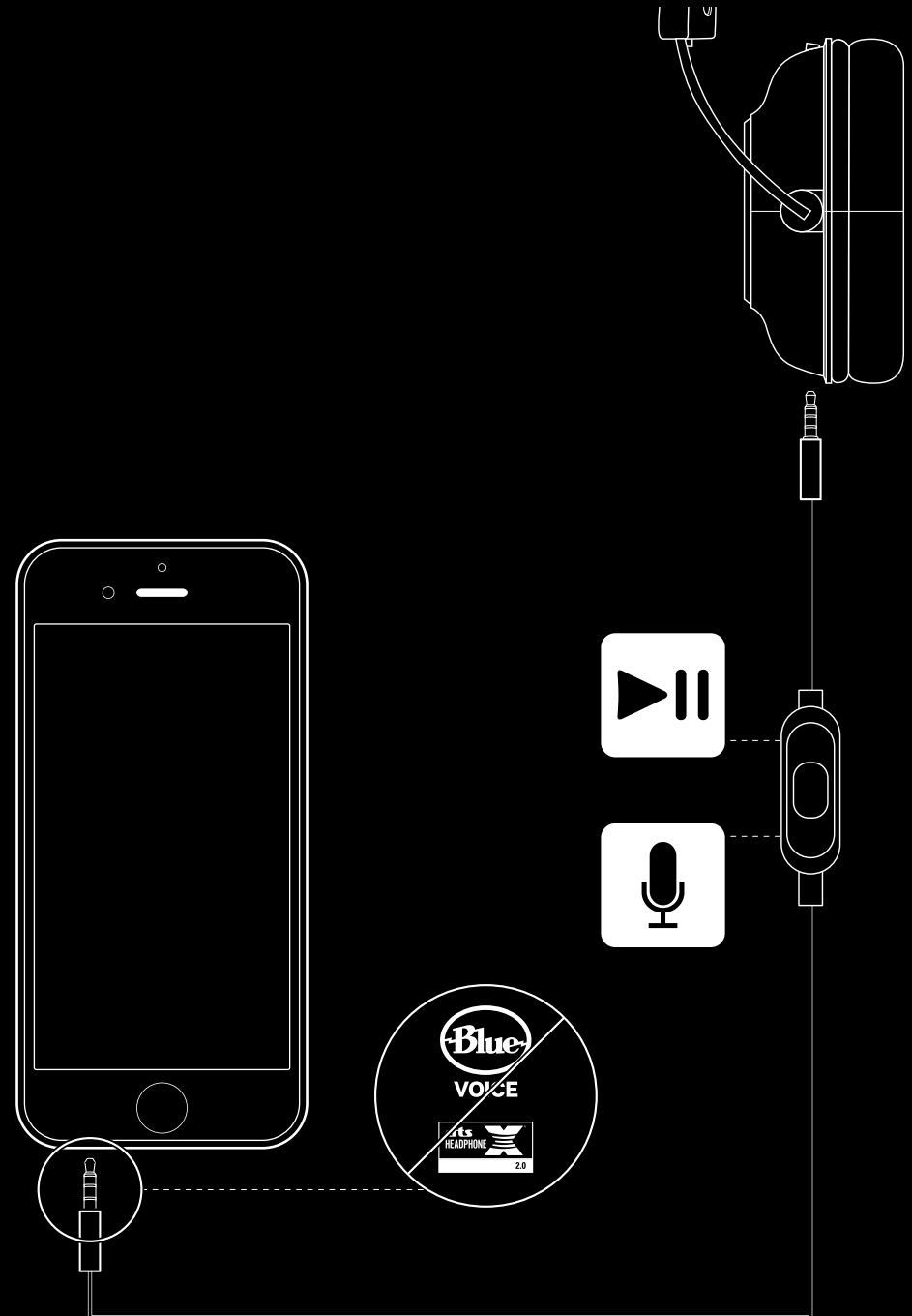

MICROPHONE PLACEMENT

Ideal placement of the microphone is at the corner of your mouth. In this position, your voice can be heard clearly without the microphone picking up breathing sounds.

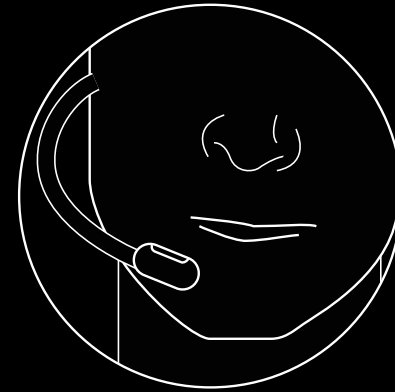

FREQUENTLY ASKED QUESTIONS

Q: How do I save a custom EQ to the USB DAC?

A: Connect the USB DAC to a PC's USB port and use G HUB software to download a pre-configured EQ from your favorite pro gamer, or to configure your own custom EQ settings. After using G HUB to save your EQ to the DAC, you can then enjoy your custom settings even on tournament PCs with no G HUB software installed.

Q: Can I save Blue VO!CE settings to the USB DAC?

A: No, Blue VO!CE technology is only available while using G HUB software and the USB DAC on PC.

Q: Can I save DTS Headphone:X 2.0 settings to the USB DAC?

A: No, DTS Headphone:X 2.0 is only available while using G HUB software and the USB DAC on PC.

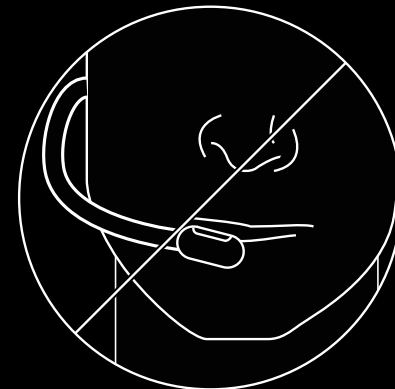

www.logitechG.com/GHUB

www.logitechG.com/support/proxheadset

CONFIGURATION SUR PC

- 1 Brancher le microphone
- 2 Brancher le câble console/PC au casque
- 3 À l'aide du DAC USB:
 1. Brancher le câble console/PC au DAC USB
 2. Brancher le DAC USB au PC¹
- 4 À l'aide de la carte son PC:
 1. Brancher le câble console/PC au séparateur PC
 2. Brancher le séparateur PC aux ports casque et micro du PC

¹ Le DAC USB active le réglage de l'égalisateur à 5 bandes, DTS Headphone:X 2.0 et les filtres pour microphone Blue VO!CE sur PC. Le téléchargement du logiciel Logitech G HUB est requis.

Le réglage de l'égalisateur à 5 bandes, DTS Headphone:X 2.0 et Blue VO!CE ne sont pas disponibles lors de l'utilisation d'une carte son pour PC.

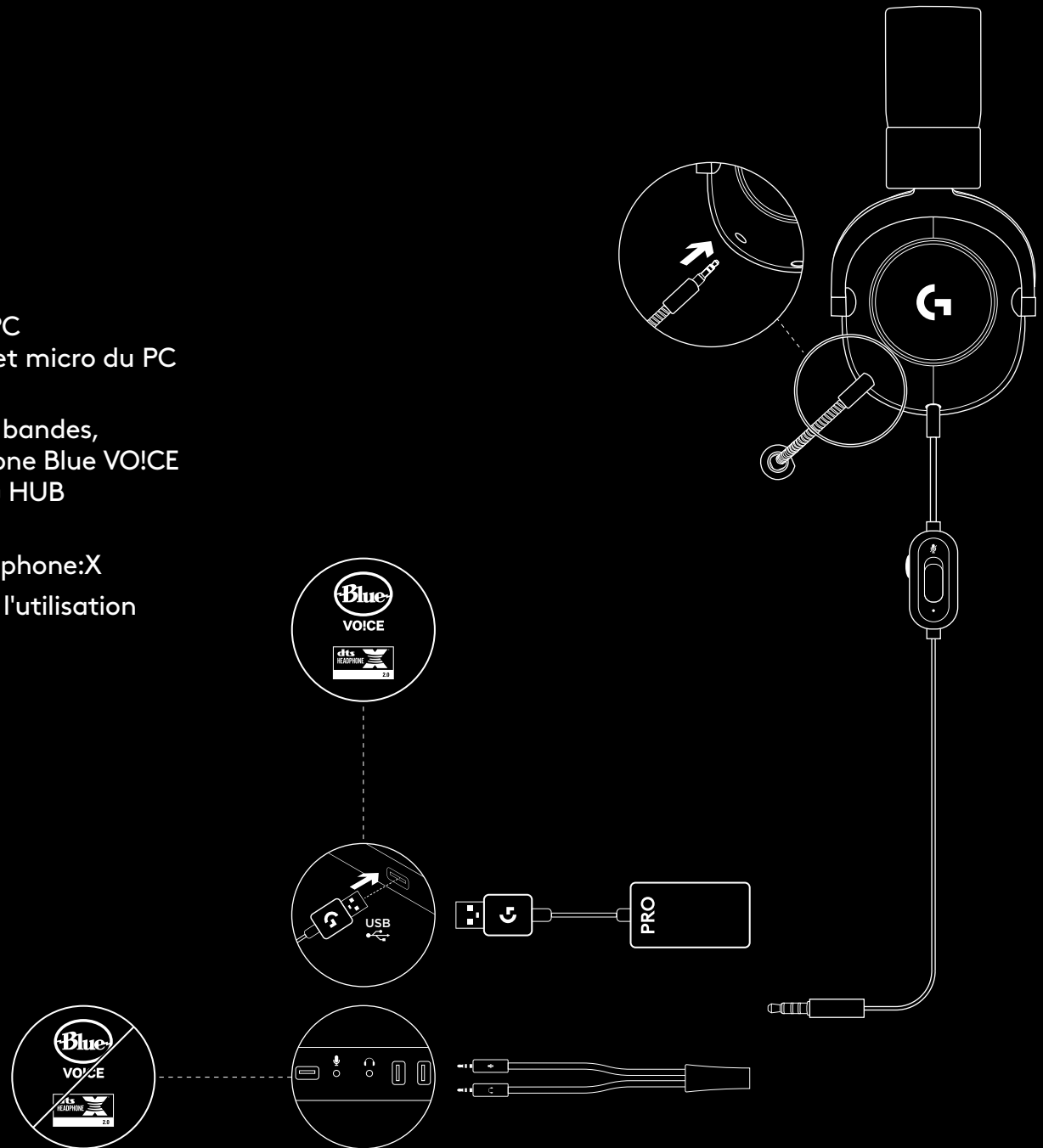

CONFIGURATION SUR CONSOLE (XBOX ONE™, PLAYSTATION® 4)

- 1 Brancher le microphone
- 2 Brancher le câble console/PC au casque
- 3 Brancher l'autre bout sur le contrôleur²

² Les instructions peuvent varier selon la version de votre système.

Consultez le manuel de votre console pour obtenir des indications supplémentaires.

Xbox One et PlayStation 4 fonctionnent uniquement en mode stéréo via un câble analogue. Certains contrôleurs Xbox One peuvent nécessiter un adaptateur de casque stéréo Xbox One (vendu séparément).

Le réglage de l'égalisateur à 5 bandes, DTS Headphone:X

2.0 et Blue VO!CE ne sont pas disponibles lorsque vous êtes connecté au contrôleur de la console.

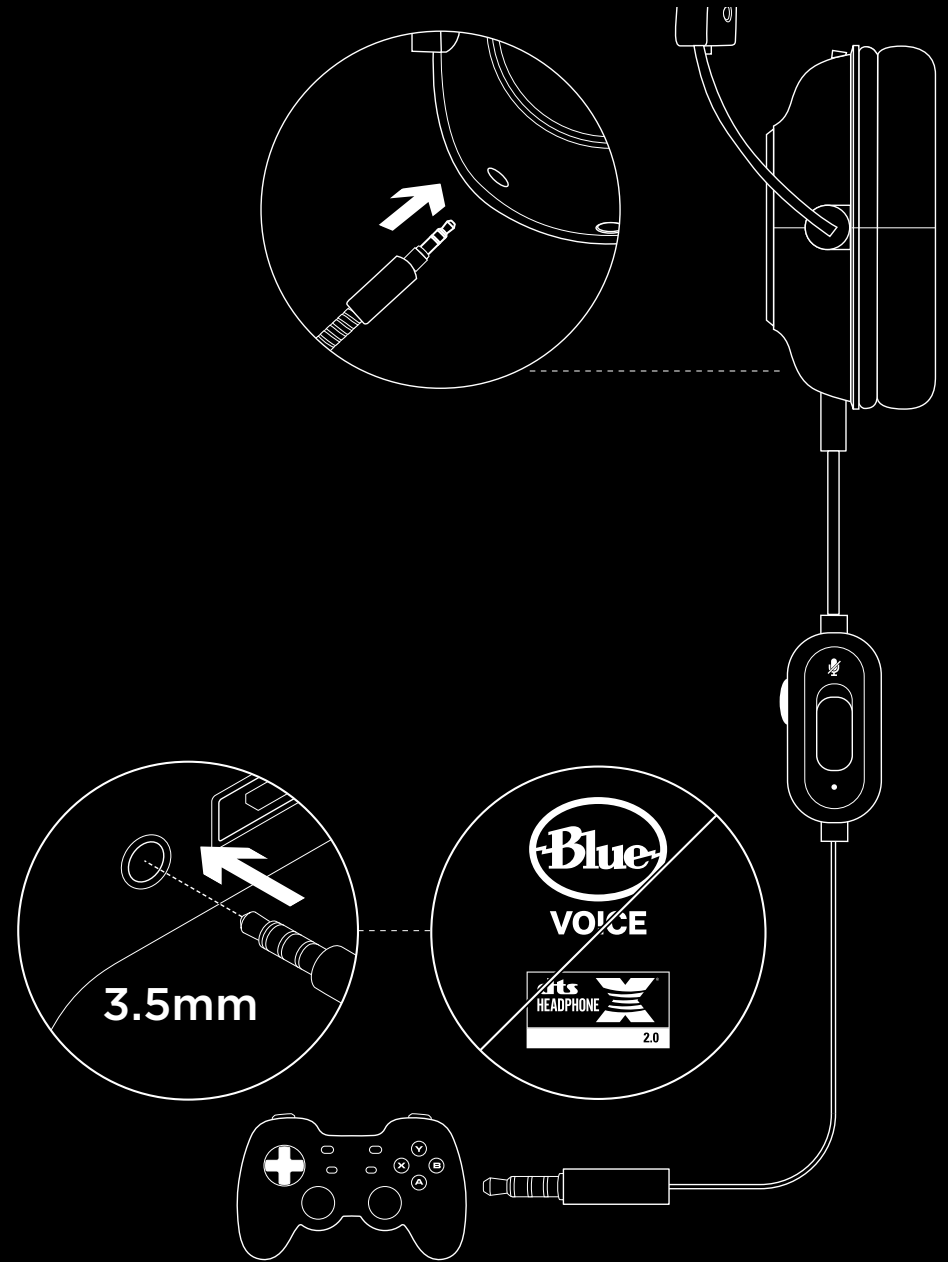

CONFIGURATION DE LA POSITION DU MICROPHONE

- 1 Retirer le microphone
- 2 Brancher le câble pour téléphone portable au casque
- 3 Brancher le câble pour téléphone portable au téléphone³

³ Le réglage de l'égalisateur à 5 bandes, DTS Headphone:X 2.0 et Blue VO!CE ne sont pas disponibles sur les dispositifs mobiles.

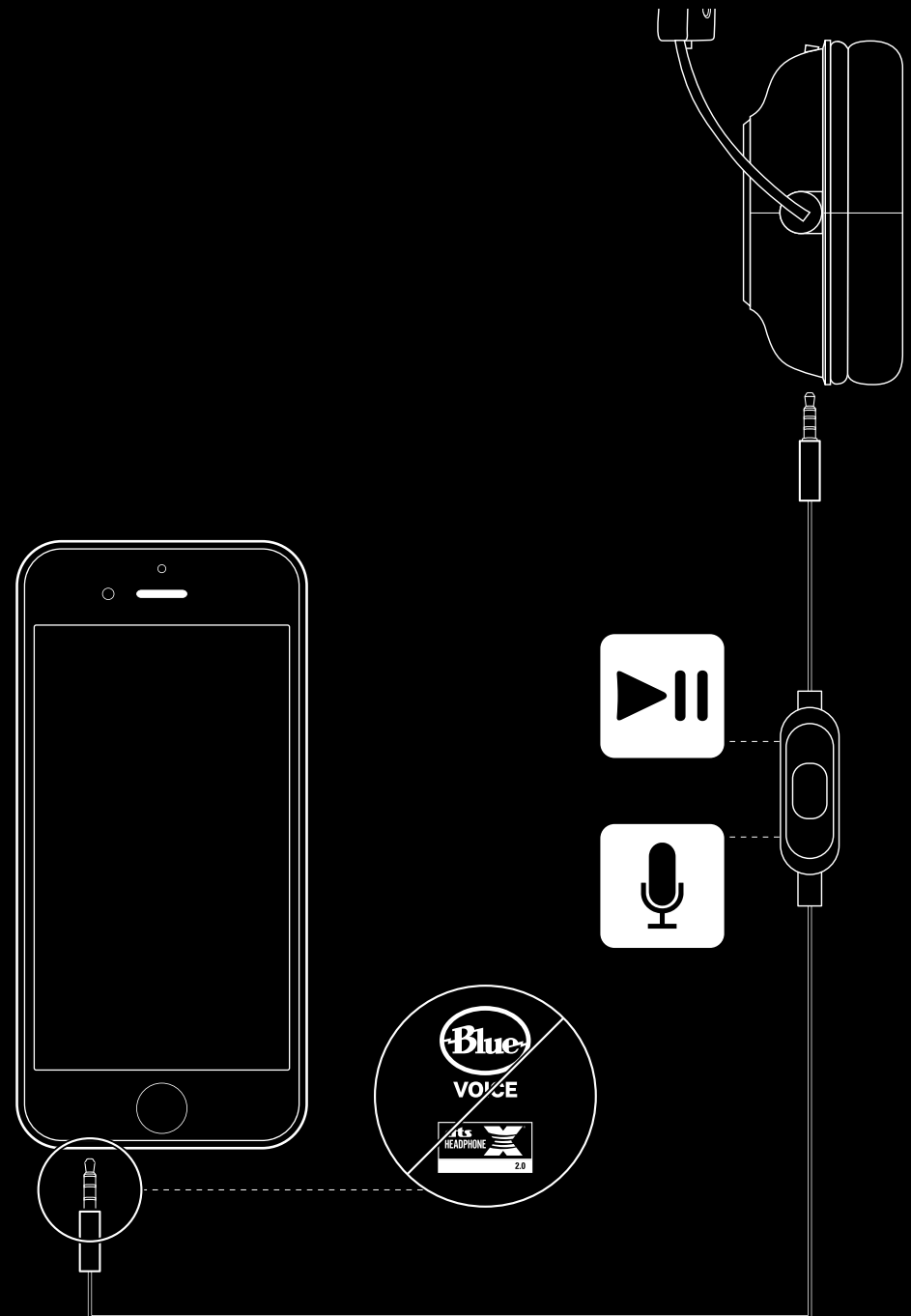

POSITIONNEMENT DU MICROPHONE

Le microphone est idéalement positionné au coin de votre bouche. Dans cette position, votre voix est retransmise en toute clarté sans que des bruits de respiration ne gênent la communication.

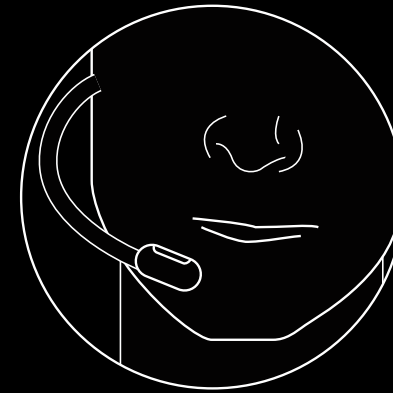

QUESTIONS FRÉQUENTES

Q: Comment personnaliser les paramètres de l'égalisateur dans le DAC USB?

R: Connectez le DAC USB au port USB d'un PC et utilisez le logiciel G HUB pour télécharger un égalisateur préconfiguré par votre gamer professionnel préféré, ou pour personnaliser vos propres paramètres d'égalisateur. Après avoir utilisé G HUB pour sauvegarder votre égalisateur dans le DAC, vous pourrez profiter de vos paramètres personnalisés même sur des PC bruyants sur lesquels aucun logiciel G HUB n'est installé.

Q: Est-il possible de sauvegarder les paramètres Blue VO!CE dans le DAC USB?

R: Non, la technologie Blue VO!CE n'est disponible que lorsque vous utilisez le logiciel G HUB et le DAC USB sur PC.

Q: Est-il possible de sauvegarder les paramètres DTS Headphone:X 2.0 dans le DAC USB?

R: Non, la technologie DTS Headphone:X 2.0 n'est disponible que lorsque vous utilisez le logiciel G HUB et le DAC USB sur PC.

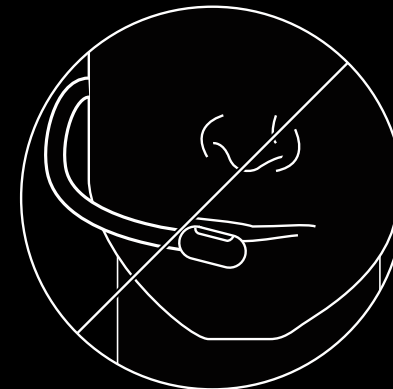

www.logitechG.com/GHUB

www.logitechG.com/support/proxheadset

CONFIGURACIÓN DE PC

- 1 Conecta el micrófono
- 2 Conecta el cable para consola/PC a los audífonos
- 3 Uso del DAC USB:
 1. Conecta el cable para consola/PC al DAC USB
 2. Conecta el DAC USB a la PC¹
- 4 Uso de la tarjeta de sonido de la PC:
 1. Conecta el cable para consola/PC al divisor para PC
 2. Conecta el divisor para PC a los puertos de audífonos y de micrófono de la PC

¹ El DAC USB incluido activa el ajuste de ecualizador de 5 bandas, DTS Headphone:X 2.0 y los filtros de micrófono Blue VO!CE en PC. Requiere la descarga del software Logitech G HUB.

El ajuste de ecualizador de 5 bandas, DTS Headphone:X 2.0 y Blue VO!CE no están disponibles cuando se usa la tarjeta de sonido de la PC.

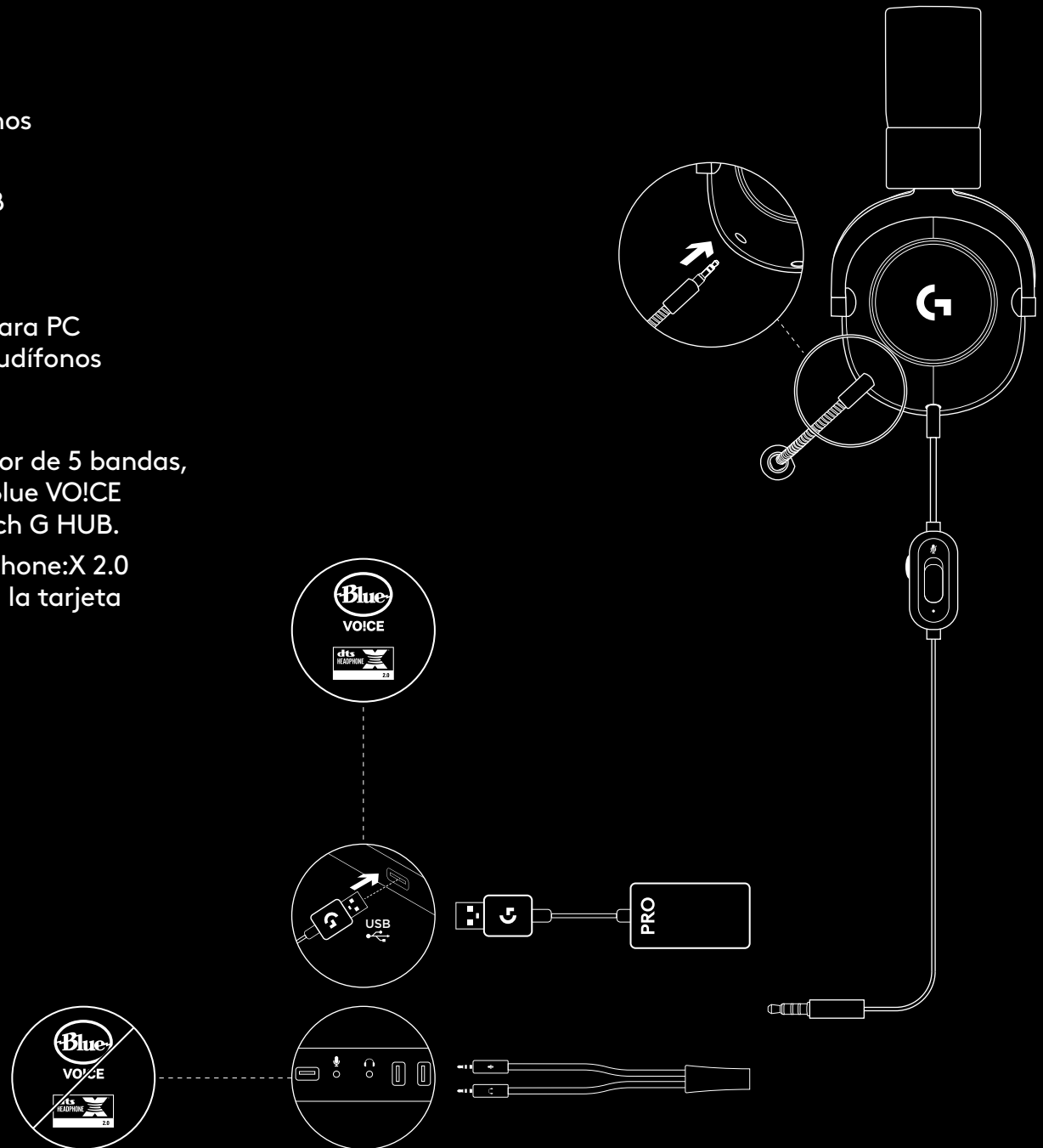

CONFIGURACIÓN DE CONSOLA (XBOX ONE™, PLAYSTATION® 4)

- 1 Conecta el micrófono
- 2 Conecta el cable para consola/PC a los audífonos
- 3 Conecta el otro extremo al mando²

² Las instrucciones pueden variar dependiendo de la versión de software del sistema.

Comprueba el manual de la consola para obtener orientación adicional.

Xbox One y PlayStation 4 funcionan en modo estéreo sólo a través del cable analógico. Algunos mandos de Xbox One pueden requerir el adaptador para audífonos estéreo Xbox One, a la venta por separado.

El ajuste de ecualizador de 5 bandas, DTS Headphone:X 2.0 y Blue VO!CE no están disponibles con la conexión al mando de la consola.

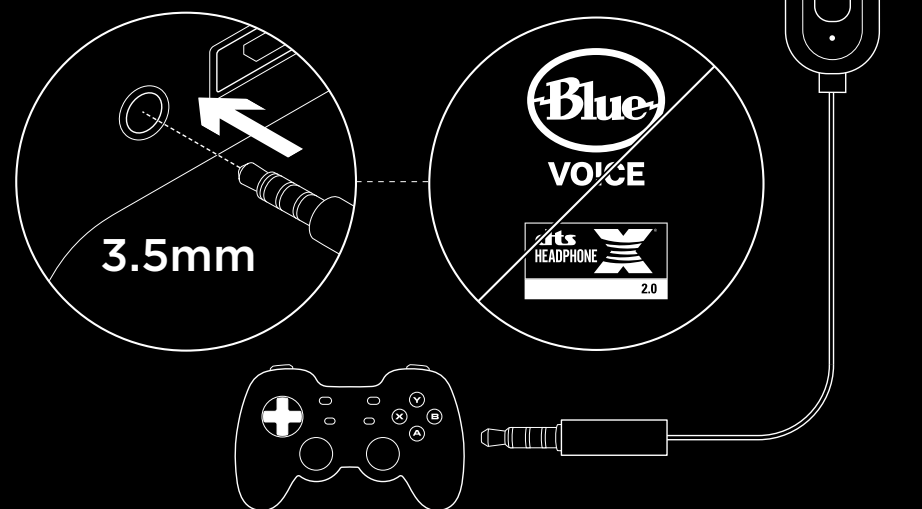

CONFIGURACIÓN DE POSICIÓN DEL MICRÓFONO

- 1 Retira el micrófono
- 2 Conecta el cable para celular a los audífonos
- 3 Conecta el cable para celular al teléfono³

³ El ajuste de ecualizador de 5 bandas, DTS Headphone:X 2.0 y Blue VO!CE no están disponibles en dispositivos móviles.

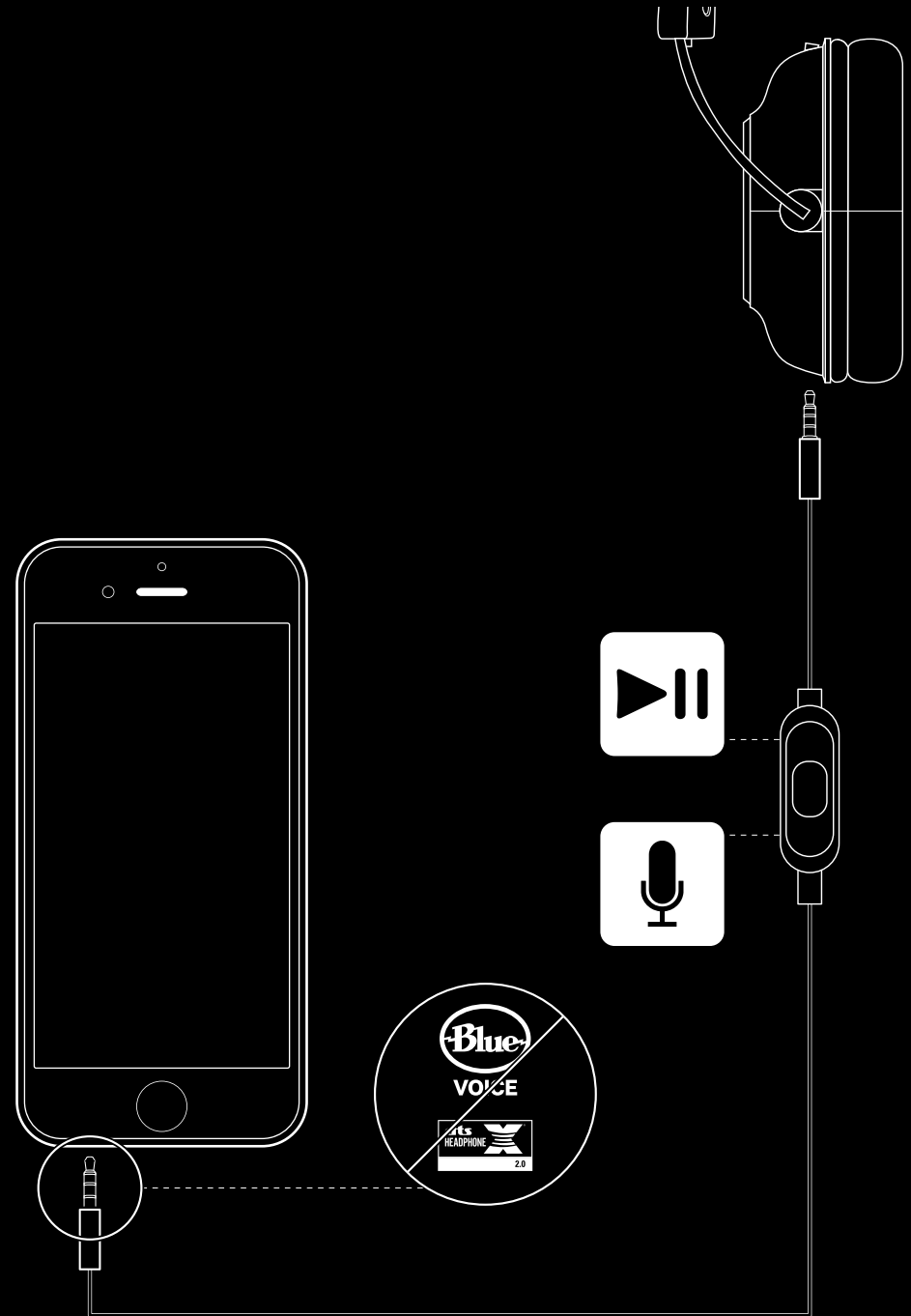

COLOCACIÓN DEL MICRÓFONO

La ubicación ideal del micrófono es en la comisura de la boca. En esta posición, tu voz se puede oír claramente sin que el micrófono capte sonidos de la respiración.

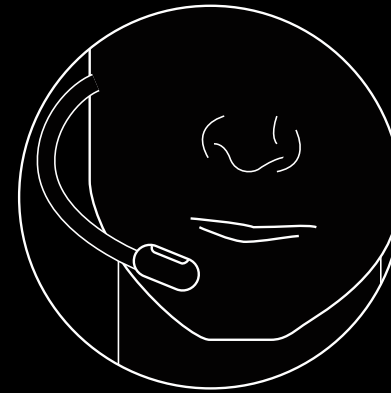

PREGUNTAS MÁS FRECUENTES

P: ¿Cómo guardo un ecualizador personalizado en el DAC USB?

R: Conecta el DAC USB a un puerto USB de computadora y usa el software G HUB para descargar un ecualizador preconfigurado de tu jugador profesional favorito, o para configurar tu propia configuración de ecualizador personalizada. Después de usar G HUB para guardar tu ecualizador en el DAC, podrás disfrutar de tu configuración personalizada incluso en computadoras de torneos sin el software G HUB instalado.

P: ¿Puedo guardar la configuración de Blue VO!CE en el DAC USB?

R: No, la tecnología Blue VO!CE sólo está disponible mientras se usan el software G HUB y el DAC USB en PC.

P: ¿Puedo guardar la configuración de DTS Headphone:X 2.0 en el DAC USB?

R: No, DTS Headphone:X 2.0 sólo está disponible mientras se usan el software G HUB y el DAC USB en PC.

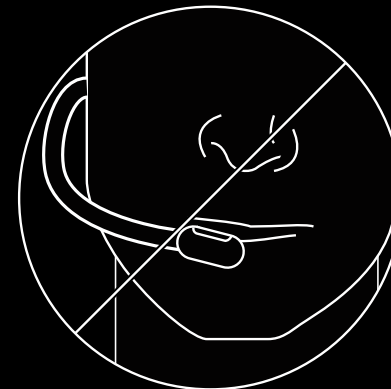

www.logitechG.com/GHUB

www.logitechG.com/support/proxheadset

INSTALAÇÃO DO PC

- 1 Conecte o microfone
- 2 Conecte o cabo do console/PC no headset
- 3 Usando o cabo USB (DAC):
 1. Conecte o cabo do console/PC no USB (DAC)
 2. Conecte o cabo USB (DAC) no PC¹
- 4 Usando a placa de som do PC:
 1. Conecte o cabo do console/PC no cabo adaptador para PC
 2. Conecte o cabo adaptador para PC no fone e nas portas do microfone e fone de ouvido

¹O DAC USB incluído permite a sintonização de equalização de 5 bandas, DTS Headphone:X 2.0 e os filtros de microfone Blue VO!CE no PC. Requer o download do software Logitech G HUB.

Sintonização de EQ de 5 bandas, DTS Headphone:X 2.0 e os filtros de microfone Blue VO!CE não estão disponíveis ao usar a placa de som do PC.

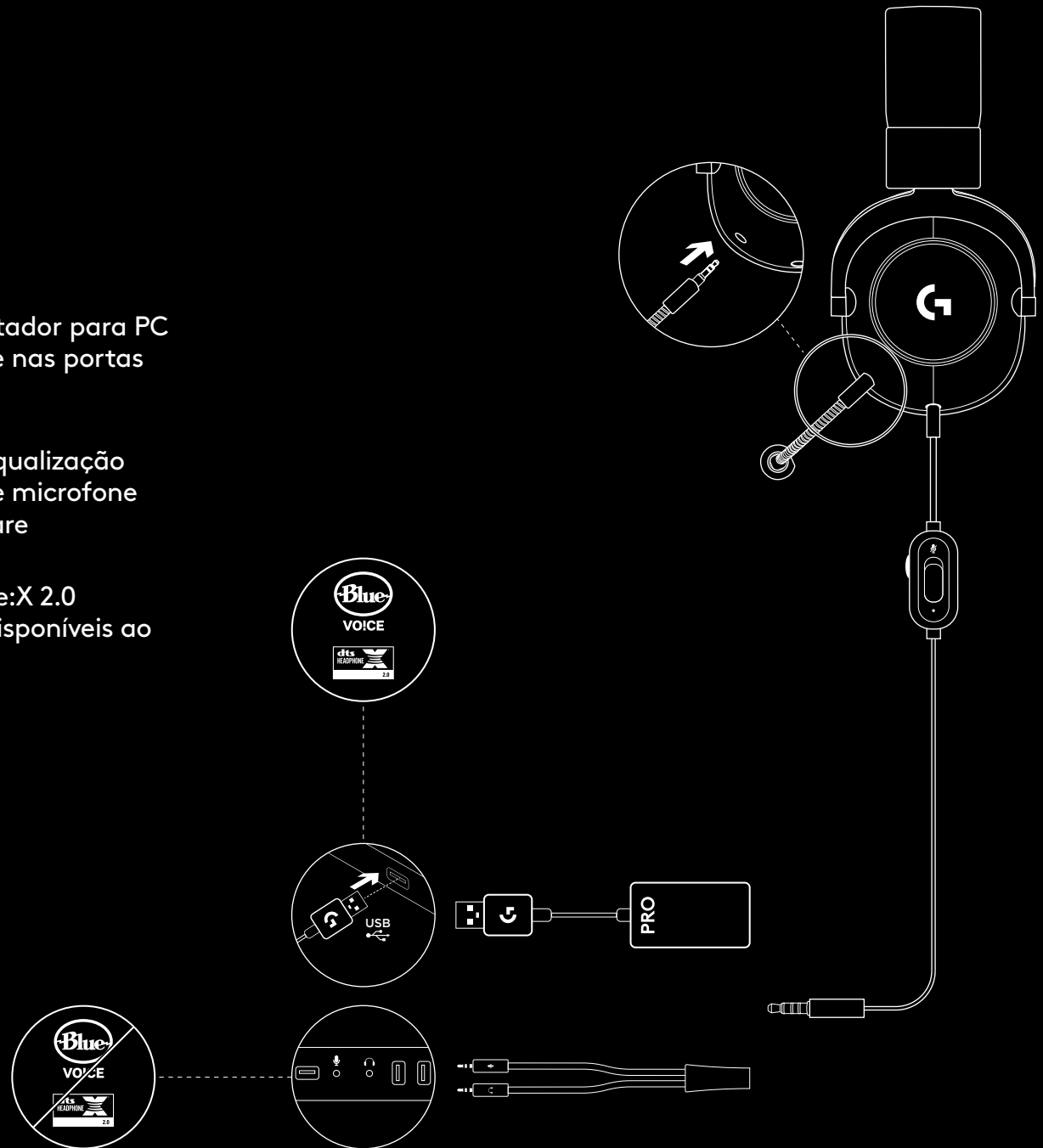

CONFIGURAÇÃO DO CONSOLE (XBOX ONE™, PLAYSTATION® 4)

- 1 Conecte o microfone
- 2 Conecte o cabo do console/PC no headset
- 3 Conecte a outra extremidade do cabo no controle²

² As instruções podem variar dependendo da versão de seu sistema.

Confira o manual do console para obter mais informações.

O Xbox One e PlayStation 4 operam apenas em modo estéreo via cabo analógico. Alguns controles de Xbox One podem precisar do adaptador estéreo para headset do Xbox One, vendido separadamente.

Sintonização de equalização de 5 bandas, DTS Headphone:X 2.0 e Blue VO!CE não estão disponíveis quando conectados ao controle do console.

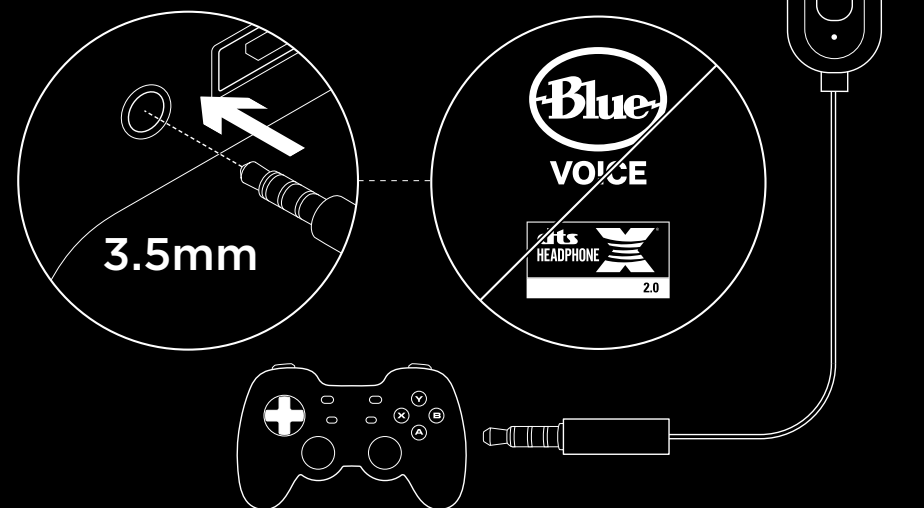

CONFIGURAÇÃO DA POSIÇÃO DO MICROFONE

- 1 Remova o microfone
- 2 Conecte o cabo para celular no headset
- 3 Conecte o cabo para celular ao telefone³

³Sintonização de equalização de 5 bandas, DTS Headphone:X 2.0 e Blue VO!CE não estão disponíveis em dispositivos móveis.

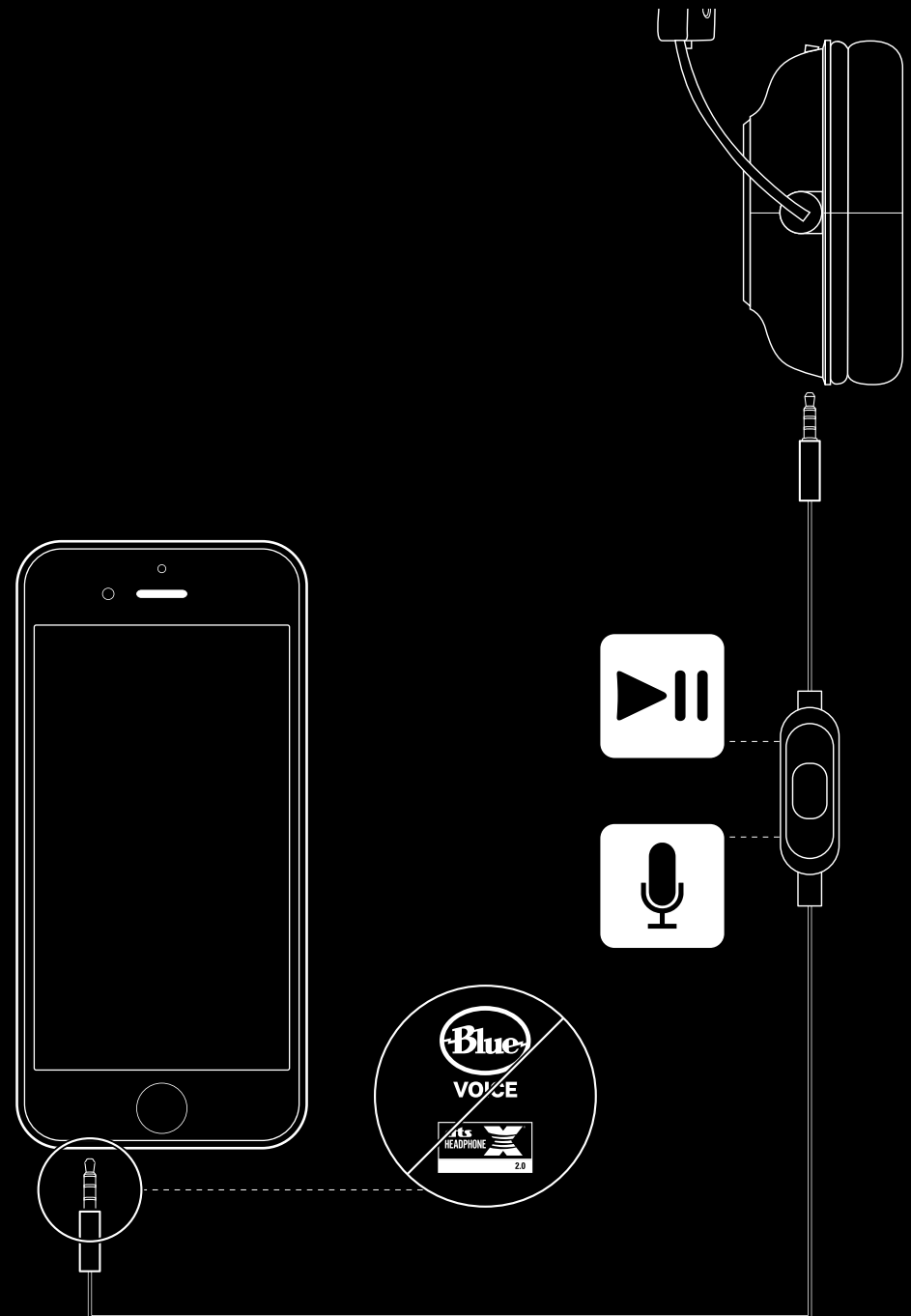

POSICIONAMENTO DO MICROFONE

Posicionamento ideal do microfone é no canto da sua boca. Nesta posição, sua voz pode ser ouvida claramente sem que o microfone capte sons respiratórios.

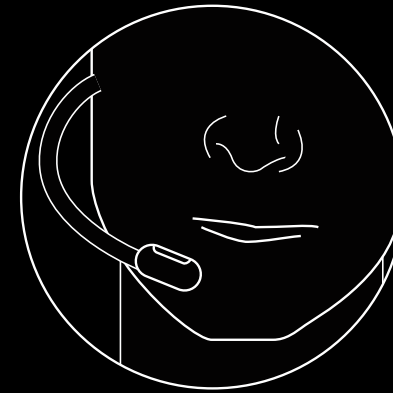

PERGUNTAS FREQUENTES

P: Como faço para salvar uma equalização personalizada para o DAC USB?

R: Conecte o USB DAC à porta USB de um PC e use o software G HUB para download de uma equalização pré-configurada de seu jogador favorito ou para configurar suas próprias definições de equalização personalizadas. Depois de usar o G HUB para salvar seu EQ no DAC, você pode desfrutar de suas configurações personalizadas, mesmo em PCs de torneio sem o software G HUB instalado.

P: Posso salvar as configurações do Blue VO!CE no USB DAC?

R: Não, a tecnologia Blue VO!CE só está disponível com o software G HUB e o USB DAC no PC.

P: Posso salvar as configurações do DTS Headphone:X 2.0 no USB DAC?

R: Não, a tecnologia DTS Headphone:X 2.0 só está disponível com o software G HUB e o USB DAC no PC.

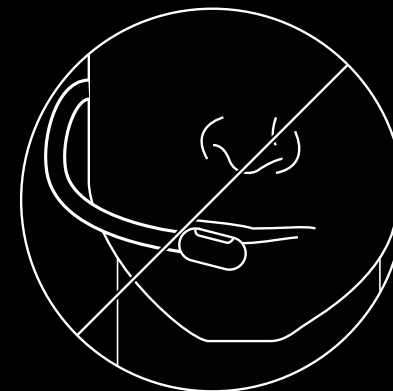

www.logitechG.com/GHUB

www.logitechG.com/support/proxheadset



© 2019 Logitech, Logitech G, Logi and their respective logos are trademarks or registered trademarks of Logitech Europe S.A. and/or its affiliates in the U.S. and other countries. For DTS patents, see <http://patents.dts.com>. Manufactured under license from DTS Licensing Limited. DTS, the Symbol, & DTS and the Symbol together, Headphone:X, and the DTS Headphone:X logo are registered trademarks or trademarks of DTS, Inc. in the United States and/or other countries. All other trademarks are the property of their respective owners.

© 2019 Logitech, Logitech G, Logi et leurs logos respectifs sont des marques commerciales ou déposées de Logitech Europe S.A. et/ou de ses sociétés affiliées aux États-Unis et dans d'autres pays. Pour les brevets DTS, rendez-vous sur <http://patents.dts.com>. Fabriqué sous licence de DTS Licensing Limited. DTS, le symbole, DTS associé au symbole, Headphone:X et le logo Headphone:X sont des marques déposées ou des marques commerciales de DTS, Inc. aux États-Unis et/ou dans d'autres pays. Toutes les autres marques sont la propriété exclusive de leurs détenteurs respectifs.

WEB-621-001474.003

Ovaj dokument je originalno proizveden i objavljen od strane proizvođača, brenda Logitech, i preuzet je sa njihove zvanične stranice. S obzirom na ovu činjenicu, Tehnoteka ističe da ne preuzima odgovornost za tačnost, celovitost ili pouzdanost informacija, podataka, mišljenja, saveta ili izjava sadržanih u ovom dokumentu.

Napominjemo da Tehnoteka nema ovlašćenje da izvrši bilo kakve izmene ili dopune na ovom dokumentu, stoga nismo odgovorni za eventualne greške, propuste ili netačnosti koje se mogu naći unutar njega. Tehnoteka ne odgovara za štetu nanесenu korisnicima pri upotrebi netačnih podataka. Ukoliko imate dodatna pitanja o proizvodu, ljubazno vas molimo da kontaktirate direktno proizvođača kako biste dobili sve detaljne informacije.

Za najnovije informacije o ceni, dostupnim akcijama i tehničkim karakteristikama proizvoda koji se pominje u ovom dokumentu, molimo posetite našu stranicu klikom na sledeći link:

<https://tehnoteka.rs/p/logitech-slusalice-g-pro-x-akcija-cena/>