

## Uputstvo za upotrebu (EN)

JBL slušalice Quantum TWS Air



by **HARMAN**



Tehnoteka je online destinacija za upoređivanje cena i karakteristika bele tehnike, potrošačke elektronike i IT uređaja kod trgovinskih lanaca i internet prodavnica u Srbiji. Naša stranica vam omogućava da istražite najnovije informacije, detaljne karakteristike i konkurentne cene proizvoda.

Posetite nas i uživajte u ekskluzivnom iskustvu pametne kupovine klikom na link:

<https://tehnoteka.rs/p/jbl-slusalice-quantum-tws-air-akcija-cena/>



# JBL QUANTUM TWS Air

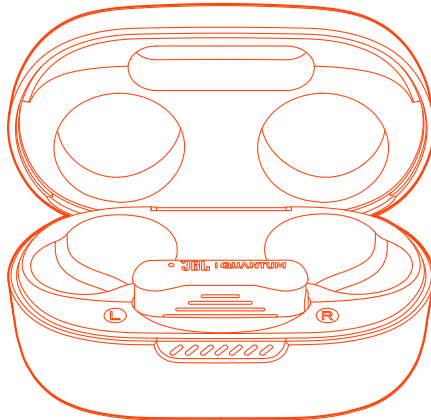

OWNER'S MANUAL

# TABLE OF CONTENTS

<b>INTRODUCTION</b> .....	<b>1</b>
<b>WHAT'S IN THE BOX</b> .....	<b>2</b>
<b>PRODUCT OVERVIEW</b> .....	<b>3</b>
Controls on earbuds.....	3
Controls on charging case.....	4
Controls on 2.4GHz USB wireless dongle.....	4
<b>GETTING STARTED</b> .....	<b>5</b>
JBL headphones app (for mobile phone only).....	5
First-time setup (for PC only) .....	5
How to wear.....	6
<b>USING YOUR EARBUDS</b> .....	<b>7</b>
First time use.....	7
Charging.....	7
Power on & connect via 2.4GHz.....	8
Power on & connect via Bluetooth .....	10
Dual source switching.....	11
Controls .....	12
Additional features.....	14
Power off.....	16
<b>LED BEHAVIOR</b> .....	<b>17</b>
<b>CLEANING THE PRODUCT</b> .....	<b>18</b>
<b>PRODUCT SPECIFICATIONS</b> .....	<b>19</b>
<b>TROUBLESHOOTING</b> .....	<b>21</b>

# INTRODUCTION

Congratulations on your purchase! This manual includes information on the JBL Quantum TWS Air gaming earbuds. We encourage you to take a few minutes to read this manual, which describes the product and includes step-by-step instructions to help you to set up and get started. Read and understand all the safety instructions before using your product.

If you have any questions about this product or its operation, please contact your retailer or customer service, or visit us at [www.JBLQuantum.com](http://www.JBLQuantum.com)

# WHAT'S IN THE BOX



01



02



03

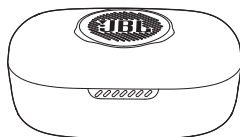

04

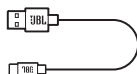

05



06

- 01 JBL Quantum TWS Air earbuds
- 02 2.4GHz USB wireless dongle (USB-C)
- 03 Silicone ear tips
- 04 Charging case
- 05 USB charging cable (USB-A to USB-C)
- 06 QSG, warranty card and safety sheet

# PRODUCT OVERVIEW

## CONTROLS ON EARBUDS



01 Charging pin

02 Replaceable silicone ear tip

03 Microphone

04 Touch control

05 LED indicator

## CONTROLS ON CHARGING CASE

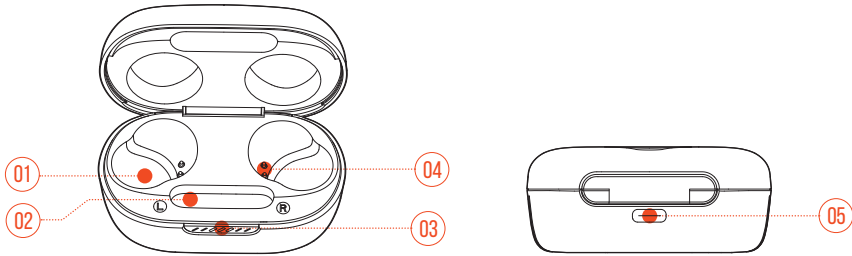

- 01 Earbud holder
- 02 Dongle holder
- 03 LED indicator
- 04 Charging pin
- 05 Charging port

## CONTROLS ON 2.4GHz USB WIRELESS DONGLE

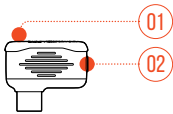

- 01 Pairing button
  - Hold for more than 5 seconds to enter 2.4GHz wireless pairing mode.
- 02 LED indicator
  - Indicates the status of 2.4GHz wireless connection.

# GETTING STARTED

## JBL HEADPHONES APP (FOR MOBILE PHONE ONLY)

On your mobile phone, download the JBL Headphones app from Apple App Store or on Google Play to get even more control and personalization of your listening experience.

## FIRST-TIME SETUP (FOR PC ONLY)

Download **JBL QuantumENGINE** from [www.jblquantum.com/engine](http://www.jblquantum.com/engine) to gain full access to features on your JBL Quantum earbuds.

## SOFTWARE REQUIREMENTS

Platform: Windows 10 (64 bit only) / Windows 11

500MB of free hard drive space for installation

### TIPS:

- Always use the latest version of Windows 10 (64 bit) or Windows 11 for the most optimal experience on JBL QuantumENGINE
  - JBL QuantumSURROUND available on Windows only. Software installation required.
1. Connect the earbuds to your PC via 2.4GHz USB wireless connection. (See ["Power on & connect via 2.4GHz"](#)).
  2. Go to **"Sound Settings"** -> **"Sound Control Panel"**.
  3. Under **"Playback"** highlight **"JBL Quantum TWS Air"** and select **"Set Default"** -> **"Default Device"**.
  4. Under **"Recording"** highlight **"JBL Quantum TWS Air"** and select **"Set Default"** -> **"Default Device"**.



5. Follow the onscreen instructions to personalize your sound settings.



## HOW TO WEAR

01

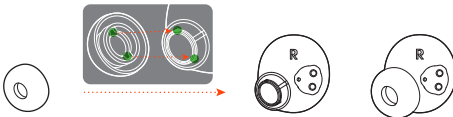

02

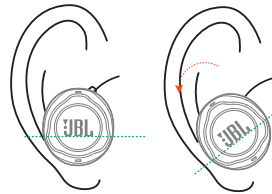

1. Choose a pair of silicone ear tips that best fits your ear size.
2. Turn the earbuds in your ears as shown for the best fit and audio performance.

# USING YOUR EARBUDS

## FIRST TIME USE

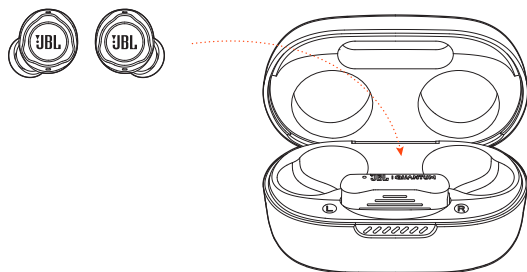

Before first time use, put the earbuds into the charging case for activation.

## CHARGING

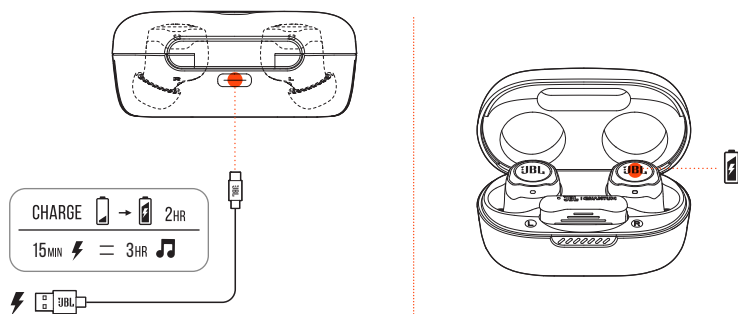

- It takes around two hours to fully charge your earbuds through the charging case.
- As a fast charging feature, a fifteen minute charge powers up your earbuds for three hours of music playback.

## TIPS:

- During charging, make sure that the charging pins on the earbuds and charging case are aligned and in good contact.
- Clean the earbuds and charging case regularly to avoid possible charging issues (see [“Cleaning the product”](#)).
- Open the lid to check the battery level of the charging case. See [“LED behavior”](#) for details. Use the provided USB cable to charge the charging case when necessary.

## POWER ON & CONNECT VIA 2.4GHz

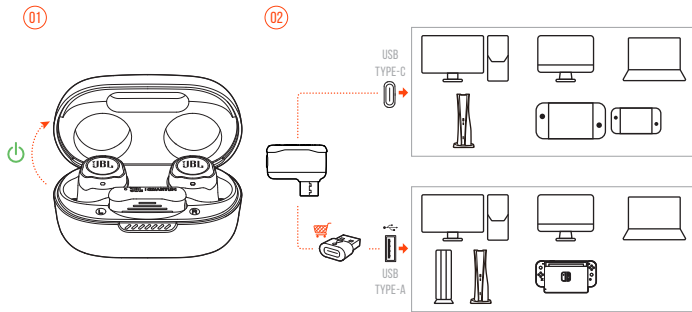

1. Plug the 2.4GHz USB wireless dongle into a USB-C port on your PC, Mac, laptop, PS5 console, or Nintendo Switch™ controller.
  - With a USB-C to USB-A converter (not supplied), you can connect the dongle to a USB-A port on your PC, Mac, desktop, PS4/PS5 console, or Nintendo Switch™ console.
2. Just open the lid of the charging case, or take out either or both of the earbuds to power up.
  - ↳ The earbuds connect to the dongle automatically.
  - ↳ After successful connection, the LED on the dongle turns solid white, and you can hear **“Dongle connected”** from the earbuds.

## TIP:

- Compatibility with all USB ports is not guaranteed.

## TO PAIR MANUALLY

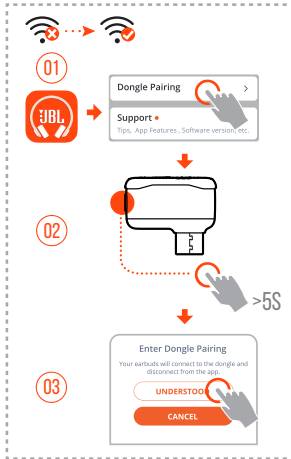

1. After Bluetooth connection (see [“Power on & connect via Bluetooth”](#)), open the JBL Headphones app to find the earbuds, then choose **“Dongle pairing”** from the app screen.
2. Follow the onscreen instructions to hold the pairing button on the 2.4GHz USB wireless dongle for more than 5 seconds until the LED flashes white quickly.
3. Choose **“UNDERSTOOD”** to disconnect the earbuds from the app.
  - ↳ The earbuds start to pair with the dongle.
  - ↳ After successful connection, the LED on the dongle turns solid white, and you can hear **“Dongle connected”** from the earbuds.

# POWER ON & CONNECT VIA BLUETOOTH

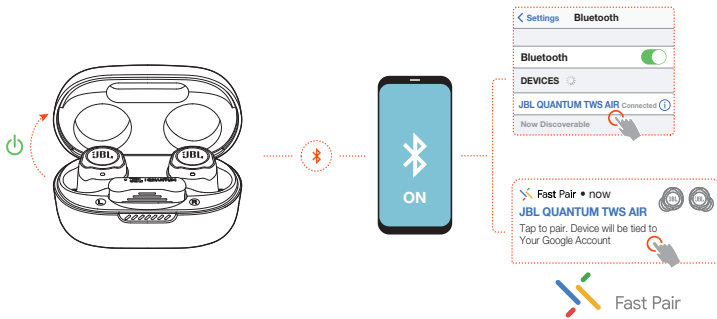

## GOOGLE FAST PAIR (FOR ANDROID 6.0+ PHONES ONLY)

1. Make sure that your mobile phone is unlocked, with the **Google Play Service** and **Location** service enabled.
2. Just open the lid of the charging case, or take out either or both of the earbuds to power up.
3. Keep your mobile phone close to the earbuds.
4. Tap the popup fast pair notification on your mobile phone.
  - ↳ After successful connection, you can hear “**BT connected**” from the earbuds.

## MANUAL PAIRING

1. Just open the lid of the charging case, or take out either or both of the earbuds to power up.
2. Enable Bluetooth on your mobile phone and choose “**JBL Quantum TWS Air**” from the bluetooth device list.
  - ↳ After successful connection, you can hear “**BT connected**” from the earbuds.

### To disconnect the current device:

On the earbuds, tap and then hold the touch control for five seconds.

- ↳ The earbuds enter Bluetooth pairing mode again.

## DUAL CONNECT + SYNC

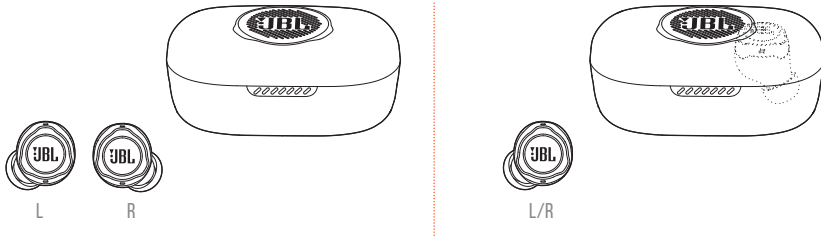

You can wear both earbuds (stereo mode), or just one (mono mode), either left or right, at a time.

## DUAL SOURCE SWITCHING

This feature allows you to switch from game audio to incoming calls or music sources quickly and easily.

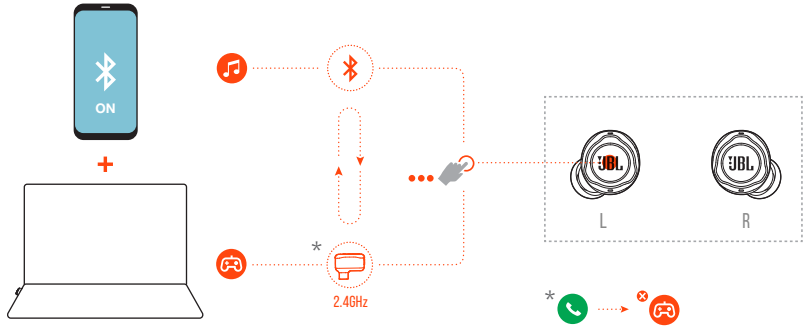

1. Ensure that your earbuds are connected to your mobile phone through Bluetooth and to your PC through 2.4GHz at the same time.
2. When you are playing games on your PC with the earbuds:
  - if there is an incoming call to your mobile phone, the game audio will be interrupted by the ring tone. You can double tap the touch area on either earbud to answer / hang up the call (See [“Call controls”](#) for details).

- you can triple tap the touch area of the left earbud to switch to music source on your mobile phone (See [“Playback controls”](#) for detailed music operation).
- To switch back to game audio from music source, triple tap the touch area of the left earbud again.

**TIP:**

- You can hear a prompt tone each time when you switch source successfully.

## CONTROLS

**NOTES:**

- The description of controls in this section is based on default settings of the earbuds.
- Enable advance controls by connecting your JBL Quantum TWS Air to JBL Headphones App  on your mobile phone or JBL QuantumEngine on your PC.
- Enable your voice assistant through JBL headphones app and assign it to your preferred earbud (L/R).

## CONTROLS AVAILABLE IN 2.4GHz CONNECTION

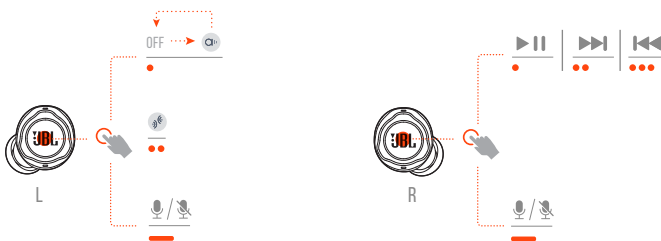

## CONTROLS AVAILABLE IN BLUETOOTH CONNECTION



## SOUND MODE SWITCHING

To switch between OFF (default) and Ambient Aware 

- Tap the touch area on the left earbud.

To enable or disable Talkthru 

- Double tap the touch area on the left earbud.

## CALL CONTROLS

### When there is an incoming call:

- Tap or double tap the touch area on either earbud to answer the call.
- Hold the touch area on either earbud for two seconds to reject the call.

### During a call:

- Double tap the touch area on either earbud to hang up.

### When making an outgoing call:

- Double tap the touch area on either earbud to cancel the call.

## MUTE/UNMUTE

- During gaming in 2.4GHz connection, hold the touch area on either earbud for two seconds to mute or unmute the microphone.
- During a call in Bluetooth connection, hold the touch area on either earbud for two seconds to mute or unmute the microphone.



## PLAYBACK CONTROLS

- Tap the touch area on the right earbud to pause or resume playback.
- Double tap the touch area on the right earbud to skip to the previous track.
- Triple tap the touch area on the right earbud to skip to the next track.

## VOICE ASSISTANTS

- Hold the touch area on either earbud for two seconds to trigger the built-in voice assistant of your mobile phone, such as BIXBY and SIRI® etc.
- Tap the touch area on either earbud or hold it for two seconds to exit.

## ADDITIONAL FEATURES

### SIDETONE

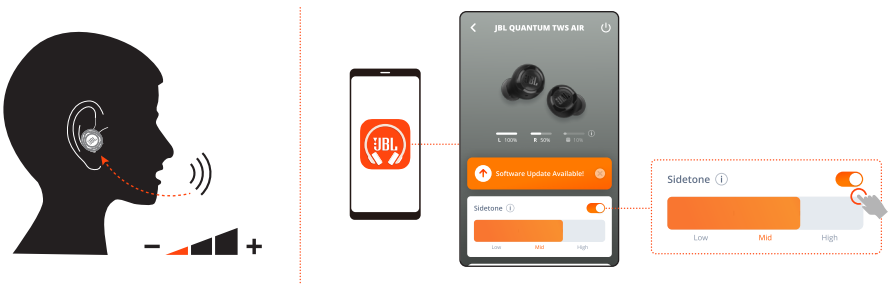

On the app, you can adjust the volume of your own voice that you can hear during a call.

## CONNECTING TO A NEW BLUETOOTH DEVICE

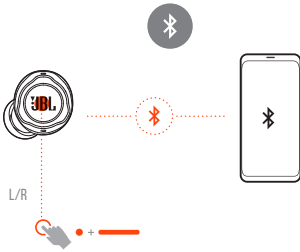

1. Take out both earbuds from the charging case.
2. Tap and then hold the touch area on either earbud for five seconds.
  - ↳ The earbuds enter Bluetooth pairing mode.
3. Repeat the Bluetooth pairing procedures for connection to a new Bluetooth device (See [“Power on & connect via Bluetooth”](#)).

## FACTORY RESET

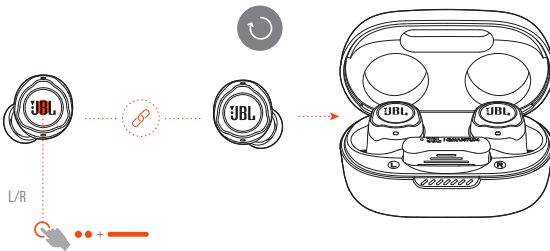

1. Take out both earbuds from the charging case.
2. Double tap and then hold the touch area on either earbud for five seconds.
  - ↳ The LEDs on both earbuds flash blue twice quickly.
  - ↳ You can hear “Power off” from the earbuds.
- To power on again, put the earbuds back into the charging case and then open the lid.

## POWER OFF

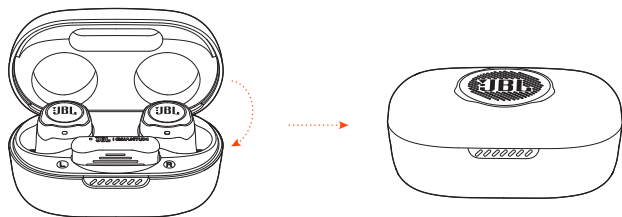

To power off, put the earbuds into the charging case and close the lid.

# LED BEHAVIOR

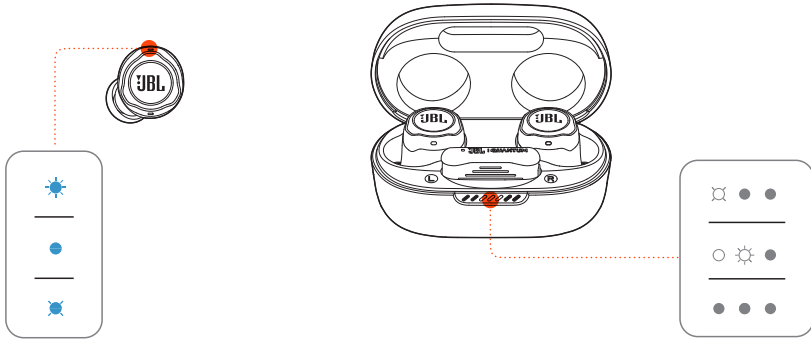

## LED on earbud:

LED indication	Status	Meaning
	Flashing blue quickly	BT connecting
	Solid blue for five seconds	BT connected
	Flashing blue slowly	BT not connected

## LEDs on charging case:

LED indication	Status	Meaning
	1 <sup>st</sup> LED flashing white for five times	Low battery
	2 <sup>nd</sup> or 3 <sup>rd</sup> LED solid white for five seconds	Charging
	All three LEDs solid white for five seconds	Fully charged

# CLEANING THE PRODUCT

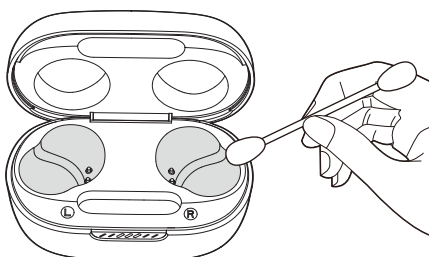
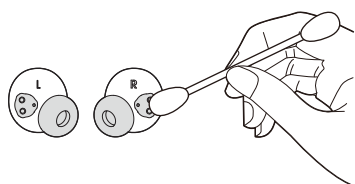

Use a clean cotton swab slightly moistened with alcohol to:

- 1. Remove earwax and dirt from the ear tips** on your earbuds.
- 2. Clean the charging pins** on your earbuds and in the charging case respectively. Then use a dry and soft cotton to rub down the dust and lint.
- 3. Clean the grooves** on the cover and at the bottom of the charging case.

**After cleaning, make sure the charging case and earbuds are dry before putting the earbuds back into the charging case.**

## **TIP:**

- You are recommended to repeat the operation every few weeks or so to keep your earbuds clean and not affect the charging speed or quality.

# PRODUCT SPECIFICATIONS

- Model: QUANTUM TWS AIR
- Driver size: 6.8 mm/0.268" Dynamic Driver
- Power supply: 5 V  $\pm$  1 A
- Earbud: 4.4 g per pc (8.8 g combined)/ 0.0097 lbs per pc (0.0194 lbs combined)
- Dongle: 2.6 g / 0.0057 lbs
- Charging case: 35.4 g / 0.078 lbs
- Earbud battery type: Lithium-ion polymer (50 mAh/3.85 V)
- Charging case battery type: Lithium-ion polymer (330 mAh/3.7 V)
- Charging time: 2 hrs from empty
- Music playtime with BT on: Up to 8 hrs
- Music playtime with 2.4GHz on: Up to 5 hrs
- Talk time with BT on: Up to 4 hrs
- Talk time with 2.4GHz on: Up to 4 hrs
- Frequency response: 20 Hz - 20 kHz
- Impedance: 16 ohm
- Sensitivity: 98 dB SPL@1 kHz
- Maximum SPL: 94 dB SPL
- Microphone sensitivity: -38 dBV/Pa@1 kHz
- Bluetooth version: 5.2
- Bluetooth profile version: A2DP V1.4, AVRCP V1.6.2, HFP V1.8
- Bluetooth transmitter frequency range: 2.4 GHz - 2.4835 GHz
- Bluetooth transmitter power: <9 dBm (EIRP)
- Bluetooth transmitter modulation: GFSK,  $\pi/4$ -DQPSK, 8-DPSK
- 2.4GHz Wireless transmitter frequency range: 2.4 GHz - 2.4835 GHz
- 2.4GHz Wireless transmitter power: <10 dBm (EIRP)
- 2.4GHz Wireless transmitter modulation: GFSK,  $\pi/4$ -DQPSK
- Maximum operation temperature: 45°C

**NOTE:**

- Technical specifications are subject to change without prior notice.

# TROUBLESHOOTING

If you have problems using this product, check the following points before you request service.

## NO POWER

- Put the earbuds back into the charging case, close the lid, and then open the lid to power on again.
- Recharge the earbuds (see ["Charging"](#)).

## 2.4GHz PAIRING FAILED BETWEEN EARBUDS AND 2.4GHz USB WIRELESS DONGLE

- Move the earbuds closer to the dongle. If the issue remains, pair the earbuds with the dongle again manually (see ["To pair manually"](#)).

## NO SOUND OR POOR SOUND

- Make sure you have chosen **JBL Quantum TWS Air** as the default device in the game sound settings of your PC, Mac or gaming console device.
- Adjust volume on your PC, Mac or gaming console device.
- You may experience obvious sound quality degradation when using the earbuds near a USB 3.0 enabled device. This is not a malfunction. Use an extension USB dock instead to keep the dongle as far from the USB 3.0 port as possible.

### In 2.4GHz wireless connection:

- Make sure the earbuds and 2.4GHz wireless dongle are paired and connected successfully.
- The USB-A or USB-C ports on some gaming console devices may be incompatible with JBL Quantum TWS Air. This is not a malfunction.



### **In Bluetooth connection:**

- The volume control on the earbuds (customizable on the JBL Headphones app) does not work for the Bluetooth connected device. This is not a malfunction.
- Keep away from sources of radio interference such as microwaves or wireless routers.

## **UNABLE TO RECHARGE MY EARBUDS**

- Recharge the charging case.
- Clean the charging pins on the earbuds and in the charging case (see [“Cleaning the product”](#)).

## **MY VOICE CANNOT BE HEARD BY MY TEAMMATES**

- Make sure you have chosen **JBL Quantum TWS Air** as the default device in the chat sound settings of your PC, Mac or gaming console device.
- Make sure the microphone is not muted.

## **I CAN'T HEAR MYSELF WHEN I'M TALKING**

- When using with a PC, enable sidetone via **JBL QuantumENGINE** to hear yourself clearly over game audio.
- When using with a mobile phone, adjust sidetone via the JBL Headphones app (see [“Sidetone”](#)).

## **NO RESPONSE OR MALFUNCTION OF THE EARBUDS**

- Restore factory settings (see [“Factory reset”](#)).
- Put the earbuds back into the charging case and close the lid. Wait for 10 seconds to finish hardware reboot before opening the lid to power on the earbuds again.

## **MY EARBUDS FALL OFF EASILY**

- Try a pair of silicone ear tips that best fits your ear size. Adjust the earbud positions in your ears for the best fit (see [“How to wear”](#)).



Ovaj dokument je originalno proizveden i objavljen od strane proizvođača, brenda JBL, i preuzet je sa njihove zvanične stranice. S obzirom na ovu činjenicu, Tehnoteka ističe da ne preuzima odgovornost za tačnost, celovitost ili pouzdanost informacija, podataka, mišljenja, saveta ili izjava sadržanih u ovom dokumentu.

Napominjemo da Tehnoteka nema ovlašćenje da izvrši bilo kakve izmene ili dopune na ovom dokumentu, stoga nismo odgovorni za eventualne greške, propuste ili netačnosti koje se mogu naći unutar njega. Tehnoteka ne odgovara za štetu nanесenu korisnicima pri upotrebi netačnih podataka. Ukoliko imate dodatna pitanja o proizvodu, ljubazno vas molimo da kontaktirate direktno proizvođača kako biste dobili sve detaljne informacije.

Za najnovije informacije o ceni, dostupnim akcijama i tehničkim karakteristikama proizvoda koji se pominje u ovom dokumentu, molimo posetite našu stranicu klikom na sledeći link:

<https://tehnoteka.rs/p/jbl-slusalice-quantum-tws-air-akcija-cena/>