

Uputstvo za upotrebu (EN)

ENERGY SISTEM slušalice Eco Cherry Wood

ENERGY  SISTEM



Tehnoteka je online destinacija za upoređivanje cena i karakteristika bele tehnike, potrošačke elektronike i IT uređaja kod trgovinskih lanaca i internet prodavnica u Srbiji. Naša stranica vam omogućava da istražite najnovije informacije, detaljne karakteristike i konkurentne cene proizvoda.

Posetite nas i uživajte u ekskluzivnom iskustvu pametne kupovine klikom na link:

<https://tehnoteka.rs/p/energy-sistem-slusalice-eco-cherry-wood-akcija-cena/>



**We love that you are rocking JLab!
We take pride in our products and fully stand behind them.**

JLAB
JBUDS AIR PRO
|
EARBUDS



YOUR WARRANTY

All warranty claims are subject to JLab authorization and at our sole discretion. Retain your proof of purchase to ensure warranty coverage.



CONTACT US

Reach out to us at support@jlab.com or visit jlab.com/contact

REGISTER TODAY

jlab.com/register

[Product updates](#) | [How-to tips](#)
[FAQs & more](#)

BLUETOOTH PAIRING

- 1 Take earbuds out of case and remove stickers. Place earbuds back in case and close door.

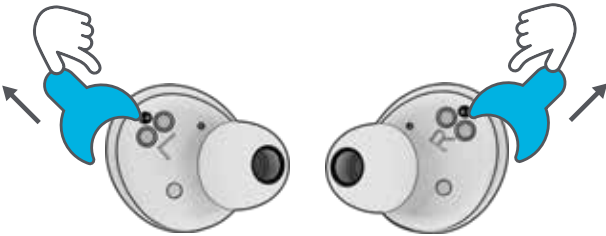

- 2 **Blue lights** on case indicates charging. Remove earbuds from case.

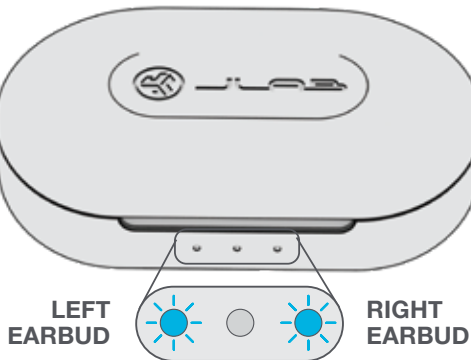

ADDING NEW / ADDITIONAL BLUETOOTH DEVICES:

Turn OFF Bluetooth from any previously connected device.
Turn ON Bluetooth from new device.

Earbuds will automatically enter Bluetooth Pairing.
Select "JLab JBuds Air Pro" in new device settings to connect.

- 3 **One earbud will blink blue/white** indicating ready to pair to your device.

Select "JLab JBuds Air Pro" in your device's Bluetooth settings.

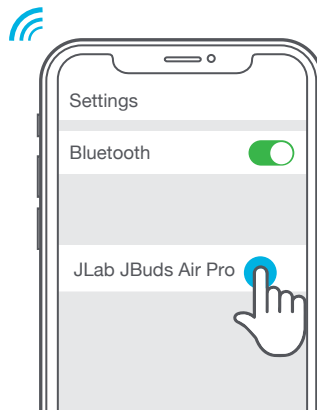
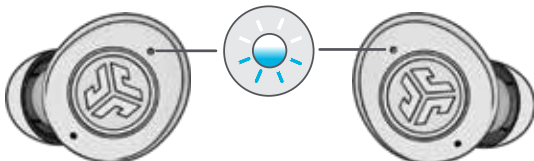

BUTTON FUNCTIONS

LEFT
EARBUD

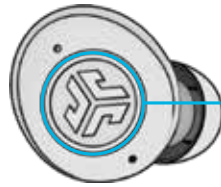
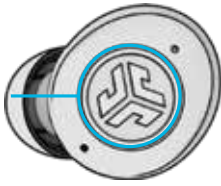

RIGHT
EARBUD

VOLUME DOWN: Single tap
SIRI (iOS) or "OK GOOGLE" (ANDROID): Double tap

MUSIC / MOVIE MODE:
Press & hold 1+ sec

TURN ON: Press & hold 3+ sec

CHANGE EQ: Triple tap
(JBuds Air Pro will cycle 3 EQ settings)

VOLUME UP: Single tap

ANSWER: Single tap

HANGUP: Double tap

REJECT INCOMING CALLS:
Press & hold 1+ sec

PLAY / PAUSE: Double tap

TRACK FORWARD: Press & hold 1+ sec

TURN ON: Press & hold 3+ sec

BE AWARE: Triple tap

VOICE PROMPTS

"Ready to Pair": JBuds Air Pro are ready to pair to Bluetooth device

"Battery Full": 100-80%

"Battery Medium": 80-20%

"Low Battery": Less than 20%
When power decreases to 10%,
"Low Battery" will play

TURN OFF WITHOUT CHARGING CASE:

Turn off Bluetooth from device settings. Earbuds will power off after 3 minutes.

CUSTOM EQ³ SOUND MODES

Tap either the right or left earbud 3 times for different EQ settings (JBuds Air Pro will cycle 3 EQ settings).



JLab SIGNATURE
JLab C3™ signature
sound with amplified
bass and vocals



BALANCED
Even sound with
no additional
enhancements



BASS BOOST
Amplified bass
and sub-bass

CHARGING EARBUDS

Placing in the charging case will auto power OFF and start charging.

Blue lights will indicate earbuds are charging and will turn OFF when fully charged.

Removing the earbuds will auto power ON and connect to last device.

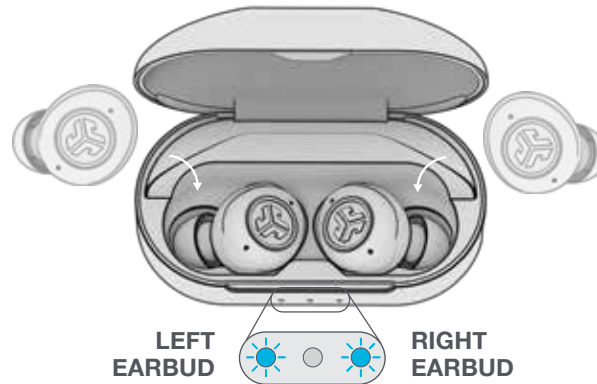

CHARGING CASE

Connect the JBuds Air Pro to computer or USB 5V 1A (or less) output device.

LEDs **pulse white** when charging and **turn solid white** when fully charged.

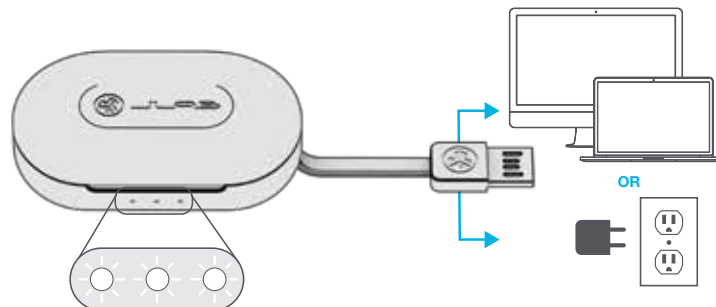

MULTIPOINT (connect 2 devices simultaneously)

- 1 Once **FIRST** device is connected, turn off Bluetooth in device settings. JBuds Air Pro will auto enter Bluetooth Pairing.



- 2 Enter your **SECOND** device Bluetooth settings and connect to JBuds Air Pro.



- 3 Enter your **FIRST** device Bluetooth settings. Turn on Bluetooth and connect to JLab JBuds Air Pro.



FITTING

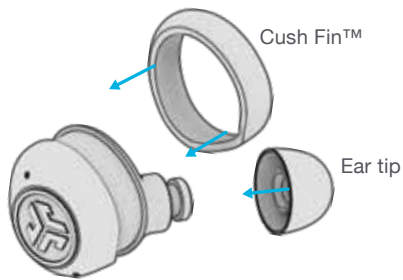

Try all the optional Cush Fins and ear tips for best fit and proper seal.

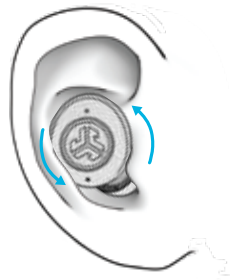

Place in ear and rotate for best fit.

FIND YOUR EARBUDS

Download the Tile app and activate to find your earbuds.

Learn more at jlab.com/tileapp

Activating Tile will reduce earbud playtime.



DOWNLOAD THE APP

Customize JBuds Air Pro features and update the latest software.

Download the JLab Sound App in Apple/Google Play Store.



TROUBLESHOOTING

NO AUDIO IN ONE EARBUD OR EARBUDS DISCONNECTED (MANUAL RESET)

1 Keep earbuds in the charging case and forget “JLab JBuds Air Pro” in your Bluetooth device settings.

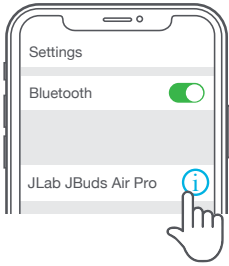

2 Quick tap 7x on one earbud in charging case. Earbud blinks blue 4 times.



7x tap

3 Quick tap 7x on other earbud in charging case. Earbud blinks blue 4 times.



7x tap

4 Take both earbuds out of the charging case. One earbud will blink blue/white indicating ready to pair to your device.



QUICK TIPS

- Either earbud can connect to your device and be used independently. Simply take out the earbud from charging case and it will auto connect.
- Choosing the correct ear tip makes a significant improvement in audio quality due to proper seal for the driver. Try all ear tips for best results.

WARNING

Fully dry off the earbuds before putting in the charging case to avoid any damage to the case.

The earbuds are sweat/water resistant but the case is not.



CAUTIONS

- Avoid extreme heat, cold, and humidity.
- Avoid dropping or crushing the earbuds.
- Wax may build up in the earbud tips, lowering the sound quality. Carefully remove the wax with a cotton swab or other small tool to improve the sound quality.
- If you experience discomfort or pain, try lowering the volume or discontinuing use temporarily.
- If you experience regular discomfort while using this product, discontinue use and consult your physician.
- We recommend you treat your earbuds as you would a nice pair of sunglasses and keep them in safe location when not in use.



[Shop products](#) | [Product alerts](#) | [Burn-in your headphones](#)

JLab Store + Burn-in Tool



Ovaj dokument je originalno proizveden i objavljen od strane proizvođača, brenda Energy Sistem, i preuzet je sa njihove zvanične stranice. S obzirom na ovu činjenicu, Tehnoteka ističe da ne preuzima odgovornost za tačnost, celovitost ili pouzdanost informacija, podataka, mišljenja, saveta ili izjava sadržanih u ovom dokumentu.

Napominjemo da Tehnoteka nema ovlašćenje da izvrši bilo kakve izmene ili dopune na ovom dokumentu, stoga nismo odgovorni za eventualne greške, propuste ili netačnosti koje se mogu naći unutar njega. Tehnoteka ne odgovara za štetu nanесenu korisnicima pri upotrebi netačnih podataka. Ukoliko imate dodatna pitanja o proizvodu, ljubazno vas molimo da kontaktirate direktno proizvođača kako biste dobili sve detaljne informacije.

Za najnovije informacije o ceni, dostupnim akcijama i tehničkim karakteristikama proizvoda koji se pominje u ovom dokumentu, molimo posetite našu stranicu klikom na sledeći link:

<https://tehnoteka.rs/p/energy-sistem-slusalice-eco-cherry-wood-akcija-cena/>