

## Uputstvo za upotrebu

FOX televizor 42ATV130E



Tehnoteka je online destinacija za upoređivanje cena i karakteristika bele tehnike, potrošačke elektronike i IT uređaja kod trgovinskih lanaca i internet prodavnica u Srbiji. Naša stranica vam omogućava da istražite najnovije informacije, detaljne karakteristike i konkurentne cene proizvoda.

Posetite nas i uživajte u ekskluzivnom iskustvu pametne kupovine klikom na link:

<https://tehnoteka.rs/p/fox-televizor-42atv130e-akcija-cena/>



## UPUTSTVO ZA UPOTREBU

# LED TELEVIZORI

Model: 42ATV130E

Hvala Vam što ste kupili ovaj uređaj.

**FOX LED** televizori prepoznaju se po odličnim tehničkim karakteristikama, kao i modernom, funkcionalnom i elegantnom dizajnu. Osim toga konstantna unapređenja u vidu postprodajne

podrške, izuzetno efikasna i rasprostranjena servisna mreža čine da se ponosni vlasnici **FOX televizora** mogu osećati sigurno.

**Napravili ste pravi izbor.**



U nastavku slede uputstva za upotrebu. Nisu komplikovana, ali ih se morate pridržavati.

SR

## VAŽNA BEZBEDONOSNA UPUTSTVA

### UPOZORENJE

KAKO BISTE SPREČILI POŽAR ILI ELEKTRIČNI UDAR NEMOJTE KORISTITI PRODUŽNI KABL, DUPLI UTIKAČ ILI DRUGE DODATKE NA UTIČNICI OSIM ONIH KOJI BI MOGLI DA SPREČE IZAZIVANJE STRUJNOG UDARA. KAKO BISTE SPREČILI POŽAR ILI ELEKTRIČNI UDAR NE IZLAŽITE OVAJ UREĐAJ VLAZI ILI KIŠI.

 <p>Ovaj simbol munje u jednakostraničnom trouglu upozorava korisnike na prisustvo opasnog i ne izolovanog napona unutar kućišta proizvoda koji može biti dovoljan da stvori rizik STRUJNOG UDARA</p>	<p><b>CAUTION</b></p> <p>RISK OF ELECTRIC SHOCK DO NOT OPEN</p> <p>Upozorenje: Da biste smanjili rizik od strujnog udara nemojte skidati poklopac (ili zadnju stranu). Unutra nema delova koje korisnik može sam da zameni. Za obavljanje servisa zatražite pomoć kvalifikovanog osoblja.</p>	 <p>Znak uzvika unutar jednakostraničnog trougla u ovom uputstvu upozorava korisnika na prisustvo važnih instrukcija za rad i održavanje (servisiranje) uređaja.</p>
--	---	---

Ovaj aparat ne treba izlagati vodi, a predmete ispunjene tečnošću poput vaza ne treba da budu postavljeni na i oko uređaja.

### OPREZ

Postoji opasnost od eksplozije ako se baterija nepropisno zameni.

Zamenite postojeću sa samo odgovarajućom vrstom baterije.

Nemojte izlagati bateriju direktnoj sunčevoj svetlosti ili bilo kojem drugom izvoru toplote.

Obezbedite pravilno odlaganje istrošenih baterija.

Ostavite lako dostupnim mesto gde je utikač ili nastavak za prekid napajanja.

Da biste smanjili rizik od strujnog udara, ne obavljajte bilo kakvo servisiranje osim onih koje se pominju u ovom uputstvu.

### VAŽNE INFORMACIJE

Ako televizor nije postavljen na dovoljno stabilnom mestu, može postojati potencijalna opasnost od pada.

Mnoge povrede, posebno dečije, mogu se izbeći primenom jednostavnih mera opreza kao što su:

Korišćenje elemenata ili stalaka koje je preporučio proizvođač televizora.

Korišćenje samo onog nameštaja koji može sigurno izdržati uređaj.

Obezbeđivanje uređaja tako da ne prelazi ivicu nameštaja.

Nemojte postavljati TV na visok nameštaj (na primer, ormare ili police) bez prethodnog pričvršćivanja kako nameštaja tako i uređaja na odgovarajuću površinu.

Ne pokrivajte televizor krpom i ne stavljajte drugi materijal između televizora i nameštaja na kom on stoji.



### Sigurna instalacija

Koristite pojas za fiksiranje televizora kako bi sprečili uređaj od pada unapred.



1. **Pročitajte uputstva**- Sve napomene o sigurnosti i načinu rada treba pročitati pre uključivanja aparata.
2. **Sačuvajte uputstva** – Uputstva za sigurnost i uputstvo za upotrebu treba da se sačuvaju za buduće potrebe.
3. **Imajte u vidu Upozorenja** – Treba se pridržavati svih upozorenja na aparatu i svih uputstava za upotrebu.
4. **Pratite uputstva**- Treba pratiti sva uputstva.



5. **Voda i vlažnost** – Aparat ne treba koristiti u blizini vode.
6. **Nosač i postolje** – Aparat treba koristiti samo sa nosačem ili postoljem koje preporučuje proizvođač
7. **Montaža na zid ili plafon** – Aparat treba da se montira na zid ili plafon samo po preporuci proizvođača.
8. **Ventilacija** – Aparat treba da bude dobro postavljen, tako da lokacija ili pozicija aparata ne ometaju njegovo provetravanje.
9. **Toplota** – Ovaj aparat treba postaviti dalje od izvora toplote kao što su radijatori i peći.
10. **Napajanje** - Aparat treba povezati samo na napajanje kao što je opisano u uputstvima za upotrebu ili onako kako je naznačeno na uređaju.
11. **Uzemljenje ili polarizacija** – Treba preduzeti mere predostrožnosti.
12. **Zaštita kabla za napajanje** – Naponski kabl treba da bude usmeren tako da je malo verovatno da se može gaziti, priklješiti stvarima na njemu i njegovom kraju.
13. **Čišćenje** – Aparat bi trebalo čistiti samo po preporuci proizvođača.
14. Napajanje spoljne antene treba da se nalazi daleko od dalekovoda.
15. **Uzemljenje spoljne antene** – Ako je spoljna antena povezana na prijemnik, antenski sistem mora biti uzemljen kako bi se obezbedila zaštita od naponskog i izvornog statičkog elektriciteta.
16. **Kada ga dugo ne koristite** – napajanje uređaja trebalo bi da bude isključeno iz utičnice kada se ne koristi duži vremenski period.
17. **Upad predmeta i tečnosti** – Treba paziti da predmeti ne upadnu, a tečnost ne prospe u kućište kroz otvore.
18. **Kada je potreban servis** – Aparat treba da servisira kvalifikovano servisno osoblje kada su:
  - Kabal za struju ili utikač oštećeni.
  - Kada predmeti upadnu ili kada se tečnost prolije po uređaju
  - Kada je aparat izložen kiši
  - Kada aparat ne radi normalno ili pokazuje značajnu promenu u radu.
19. Ventilacioni otvori ne bi trebalo da budu pokriveni predmetima, kao sto su novine, tkanine, zavese itd.
20. Izvore otvorenog plamena, kao sto su upaljene sveće, ne bi trebalo da stoje na aparatu
21. Aparat će biti povezan sa mrežnom utičnicom sa zaštitnim uzemljenjem. Utičnica ili nastavak za prekid napajanja trebaju da budu lako dostupni.

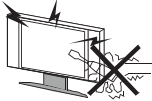

#### UPOZORENJE

Visok napon se koristi u napajanju ovog uređaja. Ne uklanjajte zadnji poklopac. Obratite se kvalifikovanoj osobi za obavljanje servisa.

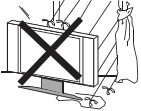

#### UPOZORENJE

Da biste sprečili požar ili strujni udar, nemojte izlagati uređaj kiši ili vlazi.



#### UPOZORENJE

Nemojte ispuštati i gurati predmete u kućište TV-a ili u otvore. Nikada nemojte prosipati tečnost na TV prijemnik.

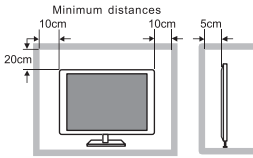

#### OPREZ

Ako televizor treba da se ugradi u zatvoreni odeljak ili na sličan način, morate se pridržavati dela uputstva o minimalnim udaljenostima. Toplota može smanjiti životni vek televizora, a takođe može biti povećan rizik od požara.



#### OPREZ

Nikada nemojte da stanete ili se oslonite ili gurnete uređaj ili stalak na kom se uređaj nalazi. Treba obratiti posebnu pažnju na decu.



#### OPREZ

Ne stavljajte glavnu jedinicu na nestabilno postolje, policu ili sto. Usled pada može doći do ozbiljne povrede lica ili štete na televizoru.



#### OPREZ

Kada se proizvod ne koristi duži vremenski period, preporučljivo je da isključite mrežni kabl iz utičnice .

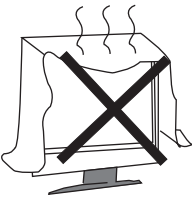

#### OPREZ

Izbegavajte izlaganje glavne jedinice direktnom suncu i drugim izvorima toplote. Ne postavljajte televizor na druge proizvode koji emituju toplotu. Na primer: Video uređaj, audio pojačala. Ne blokiraj otvore za ventilaciju u zadnjem poklopcu. Ventilacija je od suštinskog značaja za sprečavanje električnih kvarova. Ne stavljajte kabl za napajanje ispod glavne jedinice.



#### OPREZ

Panel (ekran) koji se koristi u ovom proizvodu napravljen je od stakla. Može se slomiti padom uređaja ili nasilnim udarcem. Pojedinci treba oprezno da rade sa razbijenim staklom ekrana.



- Postavite TV na stabilnu, ravnu površinu, ostavljajući najmanje 10 cm oko njega i 30 cm između vrha seta i zida ili ormarića. Da biste sprečili da se televizor prevrne kada ga gurnete, postavite ga blizu zida. Umesto da držite gornju stranu televizora kada ga okrećete, trebalo bi da držite donju stranu.

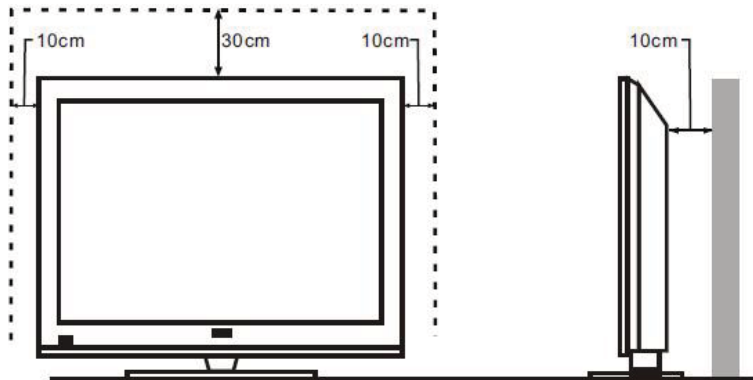

- Izbegavajte rukovanje televizorom samo jednom rukom kada ga podižete; umesto toga, koristite dve ruke.

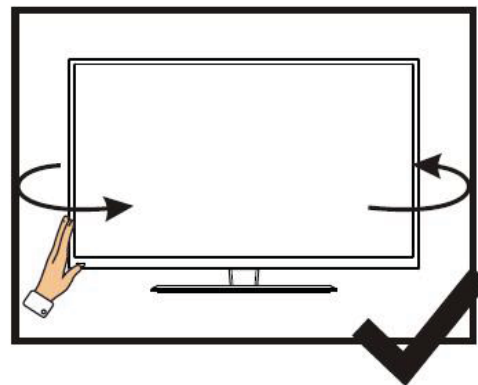
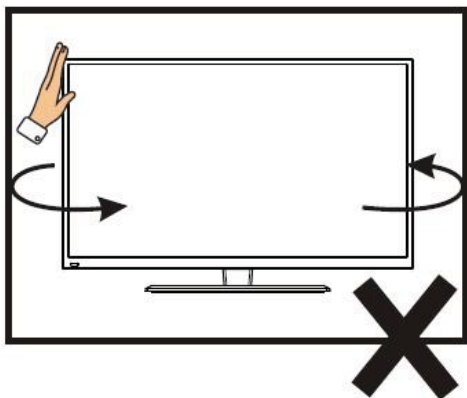

- Izbegavajte rukovanje televizorom samo jednom rukom kada ga podižete; umesto toga, koristite dve ruke.

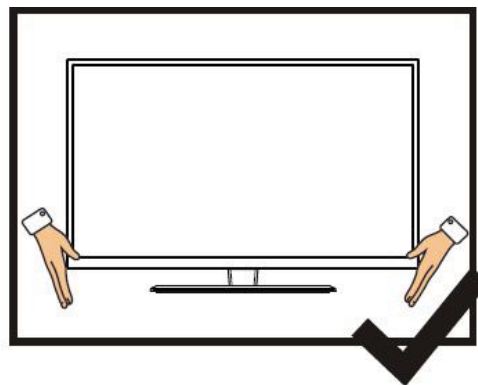
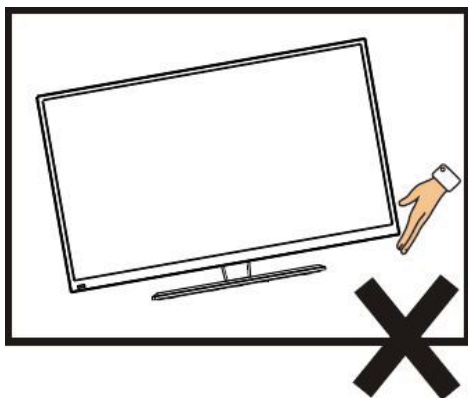

## SADRŽAJ

1.	Priključivanje i priprema TV-a.....	2
1.1	Dodatna oprema .....	2
1.2	Instalacija postolja .....	2
1.3	Dugmad i interfejsi.....	3
1.4	Daljinsko upravljanje .....	4
1.5	Instalacija baterija .....	5
2.	Osnovna operacija .....	5
2.1	Uključivanje/isključivanje (opciono) .....	5
2.2	Podешavanje režima pripravnosti .....	5
2.3	Izbor režima unosa .....	5
2.4	Podешavanje opcija menija .....	6
2.5	Meni Funkcije.....	7
2.5.1	KANAL Funkcije .....	7
2.5.2	SLIKA Funkcije .....	8
2.5.3	ZVUK Funkcije .....	9
2.5.4	VREME Funkcije .....	10
2.5.5	OPCIJA Funkcije .....	10
2.6	EKRANSKI MENI .....	11
2.7	Multimedija .....	11
2.7.1	MEDIJI Funkcije .....	11
2.7.2	USB Funkcije .....	12
2.7.3	FOTO .....	12
2.7.4	MUZIKA .....	12
2.7.5	FILM .....	13
2.7.6	TEKST .....	14
3.	Tehnička specifikacija .....	15
4.	Podržani režimi signala .....	16
5.	Jednostavno otklanjanje poteškoća .....	17

# FOX LED TV

---

## 1 Priključivanje i priprema TV-a

### 1.1 Dodatna oprema

- ✧ Uputstvo za korišćenje
- ✧ Daljinsko upravljanje
- ✧ Baterija (UM-4/R03P/AAA)
- ✧ Komplet za montiranje na zid (unapred montiran) (opciono)

### 1.2 Instalacija postolja

(Molimo pogledajte stvarni objekat za detalje o fizičkoj strukturi.)

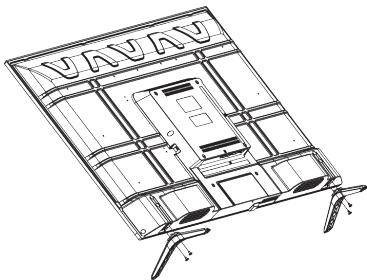

- 1) Postavite TV na mekanu tkaninu ili meke jastuke na sto tako da prednja ploča bude okrenuta nadole.
- 2) Stavite postolje u donju utičnicu televizora.
- 3) Zašrafite utičnice sa zavrtanjima na mestu, a zatim ih zategnite.



# FOX LED TV

## 1.3 Dugmad i interfejsi

Standard dizajna i specifikacije su stvarni proizvodi.

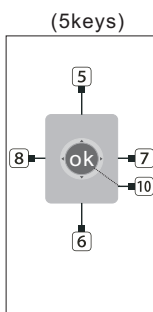
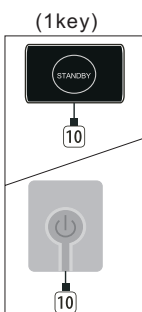
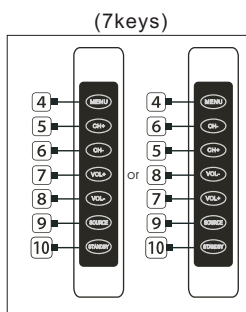
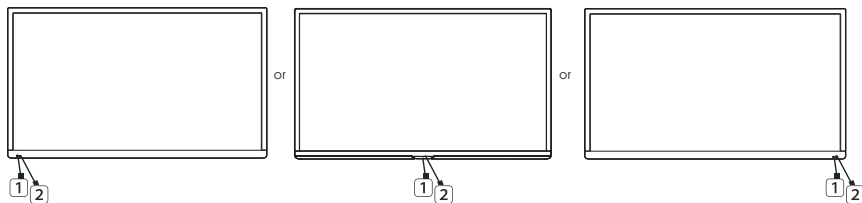

- 1 PROZOR DALJINSKOG SENZORA
- 2 INDIKATOR SNAGE
- 3 GOVORNIK
- 4 MENU DUGME
- 5 PROGRAM "+" DUGME
- 6 PROGRAM "-" DUGME
- 7 VOLUME "+" DUGME
- 8 VOLUME "-" DUGME
- 9 SOURCE DUGME
- 10 TASTER PRIPRAVNOSTI
- 11 ULAZ ZA NAPAJANJE

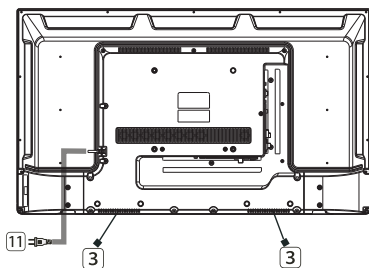

PC(VGA)	PC AUDIO	VIDEO	AV IN L	R	USB2 USB1 5V==500mA	EARPHONE
	COAXIAL	HDMI1 (ARC)	HDMI2	HDMI3	RF IN	

## 1.4 Daljinski upravljač

(Ovde je samo skica, molim vas ljubazno prevladajte)

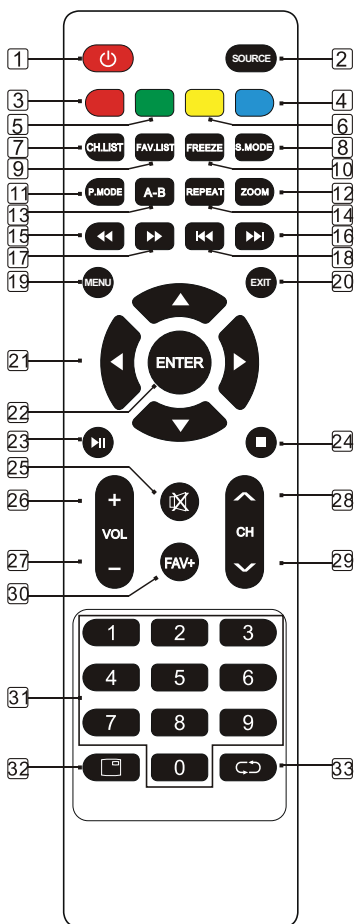

1. STANDBY: Uključivanje i isključivanje stanja pripravnosti.
2. SOURCE: Izaberite izvor signala.
3. RED: Pristupite crvenoj stavci ili stranici.
4. BLUE: Pristupite plavoj stavci ili stranici.
5. GREEN: Pristupite zelenoj stavci ili stranici.
6. YELLOW: Pristupite žutoj stavci ili stranici.
7. CH LIST: Lista kanala.
8. S.MODE: Izaberite režim zvuka.
9. FAV.LIST: Lista omiljenih kanala.
10. FREEZE: Zamrzni sliku.
11. P.MODE: Izbor režima slike.
12. ZOOM: Uvećajte ili umanjite vidljivu oblast. (Moguće je da se određene slike ili video snimci neće reprodukovati.)
13. A-B: Podesite segment ponavljanja reprodukcije.
14. REPEAT: Omogućava vam da ponovite jedan slučajni izbor, nasumični izbor i folder.
15. FB: Brzo unazad.
16. NEXT: Sledeći.
17. FF: Brzo unapred.
18. PREV.: Prethodna.
19. MENU: Unošenje ili izlazak iz menija.
20. EXIT : Izađite iz menija ili operacije.
21. ▲▼◀▶ key: Izbor stavke menija.
22. ENTER: Potvrdite ili unesite.
23. ▶|| : Pritisnite jednom da biste pauzirali, pritisnite ponovo da biste se repromativali.
24. ■ : Zaustavite reprodukciju i vratite se na listu datoteka.
25. MUTE: Utišajte zvuk.
26. VOL+: Povećajte jačinu zvuka.
27. VOL- : Smanjite jačinu zvuka.
28. CH ^: Izaberite kanal unapred.
29. CH v: Izaberite kanal unazad.
30. FAV+: Dodajte omiljeno.
31. 0-9: Ponovo pritisnite dugmad da biste izabrali kanal.
32. DISPLAY: Prikažite informacije o trenutnom videu i zvuku.
33. RECALL: Vratite se na prethodni kanal.

# FOX LED TV

---

## 1.5 Instalacija baterija

(Molim vas da prevladate, ovo je samo skica.)



- 1 Zadnji poklopac daljinskog upravljača treba da bude otvoren.
- 2 Stavite dve 7# (AAA) 1.5V baterije u sistem.  
Uverite se da su baterije pravilno polarizovane.
- 3 Pokrijte zadnji poklopac.

Izvadite baterije iz daljinskog upravljača ako ga neko vreme nije koristio.

Izvršite sledeće provere ako daljinski upravljač ne funkcioniše ispravno.

- Proverite da li je TV u programu.
- Proverite da li je polaritet baterija odgovarajući.
- Proverite da li baterije nisu iscrpljene.
- Uverite se da je napajanje u ispravnom stanju ili da je kabl za napajanje pravilno povezan.
- Uverite se da u blizini nema neobičnih neonskih ili fluorescentnih svetla.

## 2 Osnovna operacija

### 2.1 Uključivanje/isključivanje (opciono)

- Povežite kabl za napajanje sa **AC ulazni**. Utaknite kabl za napajanje u odgovarajuću utičnicu.
- Pritisnite **Prekidač** da uključite TV, zatim pritisnite **Napajanje** dugme za uključivanje jedinice.
- Pritisnite **Prekidač** ponovo da isključite TV.

Beleška: Nemojte odmah ponovo da otvarate prekidač za napajanje nakon što isključite TV; umesto toga, sačekajte jedan minut pre nego što ponovo otvorite prekidač za napajanje.

### 2.2 Podešavanje režima pripravnosti

- Pritisnite (⏻) dugme da biste uključili jedinicu.
- Pritisnite (⏻) dugme ponovo da vratite ekran u režim pripravnosti. Indikator napajanja svetli crveno.
- Uverite se da vaš TV nije ostavljen u režimu pripravnosti duži vremenski period.

### 2.3 Izbor režima unosa

Ovaj set sadrži više modova izvora signala; pritisnite dugme **Source** više puta da biste izabrali izvor signala.

# FOX LED TV

---

Kada izaberete izvor signala, informacije će biti prikazane na ekranu.

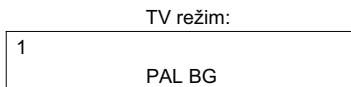

Poruka upozorenja će se pojaviti kao što je prikazano kada nema signala sa izabranog izvora. Da biste promenili izvor, promenite kanal u TV režimu ili dodirnite dugme **Source**.



## 2.4 Podešavanje opcija menija

Morate koristiti sistem menija na LED TV-u da biste podesili neke izbore nakon što stavite baterije u daljinski upravljač.

- Sledeći tasteri se koriste za promenu opcija menija: **Menu**, ▲, ▼, ◀, ▶ **Enter** dugmad.
- Pritisnite **Menu** dugme za otvaranje menija na ekranu, a zatim pritisnite ◀, ▶ dugme za izbor stranica. Prikazuje se sledeći niz stranica (kružni prikaz):

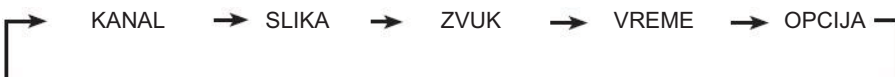

*Beleška: "KANAL" je samo za TV.*

- 1 Pritisnite **Menu** dugme za prikaz sistema menija.
- 2 Pritisnite ◀, ▶ dugme za izbor stranica menija.
- 3 Pritisnite ▲, ▼ dugme da izaberete stavku.
- 4 Pritisnite ◀, ▶ dugme da izaberete ili prilagodite podešavanje.
- 5 Meni će se automatski odbaciti nakon 10 sekundi ako ništa ne izaberete.
- 6 Pritisnite **Menu** dugme za povratak ili izlazak iz menija na ekranu.

# FOX LED TV

## 2.5 Meni Funkcije

(Za sva početna podešavanja menija, pogledajte stvarni objekat.

Samo uputstvo za upotrebu pruža detaljno objašnjenje kako da koristite uređaj.)

### 2.5.1 KANAL Funkcije

#### ※Prilagodba KANALA

1. Pritisnite **Menu** dugme, a zatim pritisnite ◀ ili ▶ dugme na stavku "**KANAL**".
2. Pritisnite ▲ ili ▼ dugme da označite "Automatsko Štimovanje", "ATV Ručno štimovanje", "Uređivanje programi", a zatim pritisnite dugme **ENTER** da promenite postavku.
3. Da biste se vratili ili izašli, pritisnite dugme **Menu**.

※ Da biste automatski pretražili i sačuvali kanale, izaberite "Automatsko štimovanje" u meniju "KANAL", a zatim pritisnite dugme **ENTER**.

※ Izaberite "ATV Ručno štimovanje" iz "KANAL" menija, a zatim pritisnite dugme **ENTER** da biste izmenili postavku.

- **Trenutni CH** Postavite broj kanala
- **Boja sistem** Izaberite boja sistem PAL/SECAM/NTSC
- **Zvučni sistem** Izaberite zvučni sistem (DK/BG/M/N/I)
- **Fino štimovanje** Podesite frekvenciju kanala na preciznu vrednost.
- **AFC** Automatsko fino štimovanje.
- Pretraga Pritisnite ◀ da tražite nadole od trenutne frekvencije, pa pritisnite ▶ tražiti gore.

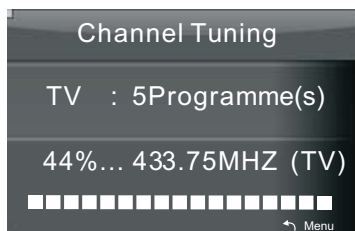
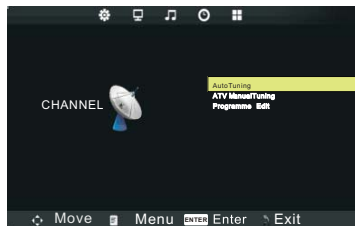

# FOX LED TV

※ Izaberite "Uređivanje programi" iz "KANAL" menija, a zatim pritisnite dugme **ENTER** da biste izmenili postavku.

- Taster za prečicu za programiranje kanala je taster sa četiri boje.
- Prvo pritisnite ▲/▼ da biste istakli kanal koji želite da izbrisete ili preimenujete, premestite ili preskočite, zatim:
- Pritisnite **Red** dugme da obrišete kanal.
- Pritisnite **Green** dugme za ulazak u stanje preimenovanja, a zatim pritisnite ◀/▶ da biste izabrali reč koju želite da promenite, i ▲/▼ da biste izabrali reč.
- Pritisnite **Yellow** dugme za postavljanje kanala u pokretno stanje. Zatim pritisnite ▲/▼ da ga pomerite na poziciju koju želite da postavite.
- Pritisnite **Blue** dugme da biste preskočili izabrani kanal.  
(Kada koristite CH+/- za gledanje kanala, vaš TV će automatski preskočiti kanal.)
- **Fav** Dodajte ili izbrisite kanal na svoju listu favorita.



## 2.5.2 SLIKA Funkcije

※Prilagodba SLIKA.

1. Pritisnite **Menu** dugme, a zatim pritisnite ◀ ili ▶ dugme na stavku "**SLIKA**".
2. Pritisnite ▲ ili ▼ dugme da biste istakli stavku "Režim slike", "Temperatura boje", "Smanjenje šuma", a zatim pritisnite dugme **ENTER** da uđete u podmeni.
3. U podmeniju, pritisnite ◀ ili ▶ dugme za podešavanje različitih podešavanja.
4. Da biste se vratili ili izašli, pritisnite dugme **Menu**.

※ Izaberite "Režim slike" iz "SLIKA" menija, a zatim pritisnite dugme **ENTER** da biste izmenili postavku.

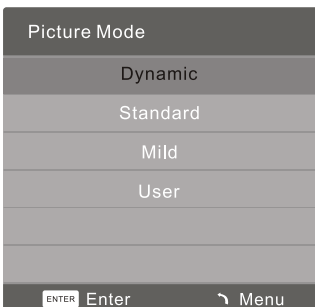
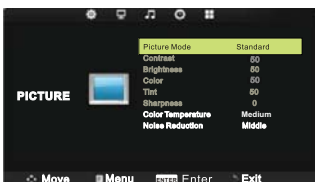

# FOX LED TV

## Temperatura boje

Izaberite "Temperatura boje" iz "SLIKA" menija, a zatim pritisnite dugme **ENTER** da biste izmenili postavku: "Hladno", "Srednje", "Toplo".

## Smanjenje buke

Izaberite "Smanjenje buke" iz "SLIKA" menija, a zatim pritisnite dugme **ENTER** da biste izmenili postavku: "Isključeno", "Nisko", "Srednja", "Visoka".

## 2.5.3 ZVUK Funkcije

### ※Prilagodba ZVUK

1. Pritisnite **Menu** dugme, a zatim pritisnite ◀ ili ▶ dugme na stavku "**ZVUK**".
2. Pritisnite ▲ ili ▼ dugme za isticanje "Režim zvuka", "Ravnoteža", "Okruziti" "Automatska jačina zvuka", a zatim pritisnite dugme **ENTER** da uđete u podmeni.
3. U podmeniju, pritisnite ◀ ili ▶ dugme za podešavanje različitih podešavanja.
4. Da biste se vratili ili izašli, pritisnite dugme **Menu**.

## Režim zvuka

Izaberite "Režim zvuka" iz "ZVUK" menija, a zatim pritisnite dugme ▲ ili ▼ dugme da biste izmenili postavku: "Standardno", "Film", "Muzika", "Sport", "Korisnik"

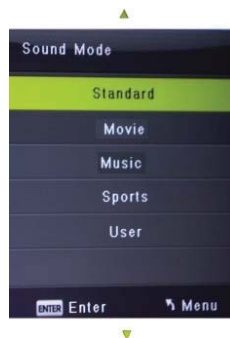
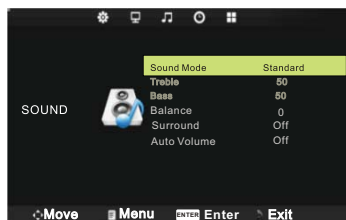
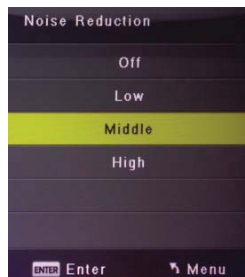

# FOX LED TV

## 2.5.4 VREME Funkcije

※Prilagodba VREME

1. Pritisnite Menu dugme, a zatim pritisnite ◀ ili ▶ dugme na stavku "**VREME**".
2. Pritisnite ▲ ili ▼ dugme za isticanje stavke "Spavaj Tajmer", "Automatsko Spavanje" ili "OSD tajmer", a zatim pritisnite dugme **ENTER** da uđete u podmeni.
3. U podmeniju, pritisnite ▲ ili ▼ dugme za podešavanje različitih podešavanja.
4. Da biste se vratili ili izašli, pritisnite dugme **Menu**.

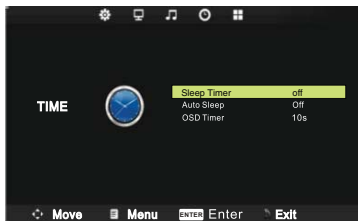

## 2.5.5 OPCIJA Funkcije

※Prilagodba OPCIJA

1. Pritisnite **Menu** dugme, a zatim pritisnite ◀ ili ▶ dugme na stavku "**OPCIJA**".
2. Pritisnite ▲ ili ▼ dugme da biste istakli stavku "OSD jezik", "Proporcija širine i visine", "Plavi ekran", "Zaključavanje tastera", "HDMI CEC", "Resetovanje", a zatim pritisnite dugme **ENTER** da biste ušli u podmeni.
3. U podmeniju, pritisnite ◀ ili ▶ dugme za podešavanje različitih podešavanja.
4. Da biste se vratili ili izašli, pritisnite dugme **Menu**.

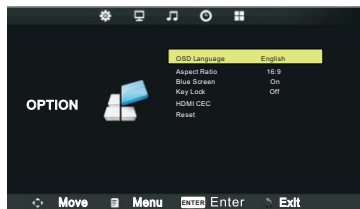

### OSD Jezik

Izaberite "OSD jezik" iz "OPCIJA" menija, a zatim pritisnite dugme **ENTER** da biste izmenili postavku.

### Proporcija širine i visine

Izaberite "Proporcija širine i visine" iz "OPCIJA" menija, a zatim pritisnite dugme **ENTER** da biste izmenili postavku.

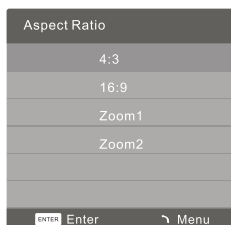



## 2.6 EKRANSKI MENI

Beleška: U PC režimu, ekranski meni je dostupan. Ekran računara je prilagođen tim komponentama.

Pritisnite ▲ ili ▼ da biste istakli jednu od sledećih opcija, a zatim pritisnite ENTER ili ► da biste ga izabrali.

**Automatsko prilagođavanje** Automatski prilagodite podešavanja sata, faze, H-Pozicije i V-Pozicije.

**Horizontalni položaj.** Pomerajte ekran gore ili dole.

**Vertikalni položaj.** Pomerite ekran nalevo ili nadesno.

**Chasovnik** Podesite brzinu unutrašnjeg sata uzorkovanja.

**Faza** Podesite unutrašnju fazu signala.



## 2.7 Multimedija

### 2.7.1 MEDIJI Funkcije

A. Podržana multimedijalna datoteka:

Multimedijalni podaci	Format
Slika	JPEG; BMP; PNG
Muzika	MP3
Video	MPEG-1(.DAT/.MPG) MPEG-2(.MPG/.VOB) MPEG-4(.AVI/.MP4) Digitalni filmovi
TXT	.txt

B. PC ne može da se poveže preko USB-a.

C. USB kompatibilni uređaji: FAT ili FAT32 je format.

D. Ne tvrdimo da će svi USB uređaji za masovno skladištenje raditi ispravno (operativno ili u smislu napajanja magistrale), i odričemo se bilo kakve odgovornosti za bilo kakav gubitak podataka koji može nastati kao rezultat povezivanja sa ovom jedinicom.

Ažurirajte sve formate datoteka (audio, foto, video)

# FOX LED TV

---

## 2.7.2 USB Funkcije

### ※Prilagodba USB

1. Pritisnite dugme SOURCE, a zatim pritisnite ▲ ili ▼ dugme da biste istakli "MEDIA" stavku, a zatim pritisnite dugme ENTER.
2. Pritisnite ◀ ili ▶ dugme da biste istakli stavku "FOTO", "MUZIKA", "FILM", "TEKST", a zatim pritisnite dugme ENTER.
3. Pritisnite dugme SOURCE da biste se vratili ili izašli.

## 2.7.3 FOTO

- A. Pritisnite ◀ ili ▶ da biste izabrali fasciklu ili datoteku, pritisnite dugme **ENTER** da biste ušli u sledeći folder, pritisnite **RECALL** da biste se vratili u prethodni folder.
- B. Pritisnite ◀ ili ▶ da biste izabrali **PHOTO** koji želite, pritisnite dugme **ENTER** da biste izabrali listu pesama, a zatim pritisnite ► dugme da biste igrali.
- C. Pritisnite dugme **Displai** do medijske stavke.
- D. Pritisnite ◀ ili ▶ dugme da biste označili medij, a zatim pritisnite dugme **ENTER**.

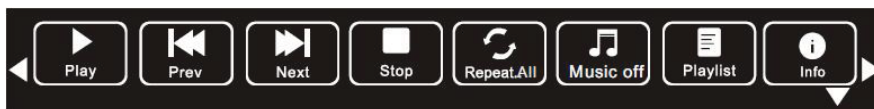

Pusti/pauziraj, Prethodna, Sledeća, Zaustaviti, Ponovi SVE, Muzika isključena, Lista za reprodukciju, Informacije. .



Rotirajte, Rotirajte, Uvećaj, Umanji, Premesti prikaz, Izvor muzike.

## 2.7.4 MUZIKA

- A. Pritisnite ◀ ili ▶ da biste izabrali fasciklu ili datoteku, pritisnite dugme **ENTER** da biste ušli u sledeći folder, pritisnite **RECALL** da biste se vratili u prethodni folder.
- B. Pritisnite ◀ ili ▶ da biste izabrali **MUSIC** koji želite, pritisnite dugme **ENTER** da biste izabrali listu pesama, a zatim pritisnite ► dugme da biste igrali.
- C. Pritisnite dugme **Displai** do medijske stavke.
- D. Pritisnite ◀ ili ▶ dugme da biste označili medij, a zatim pritisnite dugme **ENTER**.



Pusti/pauziraj, Brzo unazad, Premotaj unapred, Prethodna, Sledeća, Zaustaviti, Ponovi SVE, MUTE.

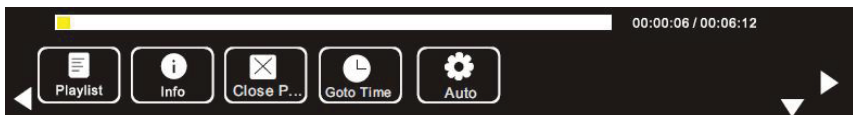

Lista za reprodukciju, Informacije, Zatvori panel, Idi na vreme, Automatski.

## 2.7.5 FILM

- Pritisnite ◀ ili ▶ da biste izabrali fasciklu ili datoteku, pritisnite dugme **ENTER** da biste ušli u sledeći folder, pritisnite **RECALL** da biste se vratili u prethodni folder.
- Pritisnite ◀ ili ▶ da biste izabrali **MOVIE** koji želite, pritisnite dugme **ENTER** da biste izabrali listu pesama, a zatim pritisnite ▶ dugme da biste igrali.
- Pritisnite dugme Displai do medijske stavke.
- Pritisnite ◀ ili ▶ dugme da označite medij, a zatim pritisnite dugme **ENTER**.

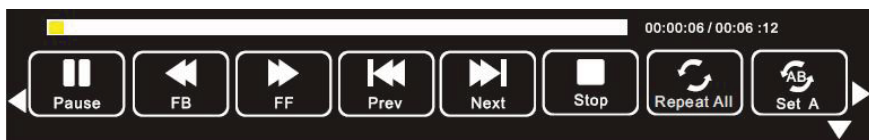

Pusti/pauziraj, Brzo unazad, Premotaj unapred, Prethodna, Sledeća, Zaustaviti, Ponovi SVE, Postavi A/B



Lista za reprodukciju, Informacije, Sporo Fv, Korak Fv, Idi na vreme, Povećaj, Umanji, Proporcija širine i visine



Automatski, Premesti prikaz.

# FOX LED TV

---

## 2.7.6 TEKST

- A. Pritisnite ◀ ili ▶ da biste izabrali fasciklu ili datoteku, pritisnite dugme **ENTER** da biste ušli u sledeći folder, pritisnite **RECALL** da biste se vratili u prethodni folder.
- B. Pritisnite ◀ ili ▶ da biste izabrali **TEXT** koji želite, pritisnite dugme **ENTER** da biste izabrali listu pesama, a zatim pritisnite ▶ dugme da biste igrali.
- C. Pritisnite dugme **Displai** do medijske stavke.
- D. Pritisnite ◀ ili ▶ dugme da biste označili medij, a zatim pritisnite dugme **ENTER**.



Prethodna stranica, Sledeća stranica, Prethodna, Sledeća, Zaustaviti, Muzika isključena, Lista za reprodukciju, Informacije



Izvor muzike, Automatski.

# FOX LED TV

---

## 3. Tehnička specifikacija

Model proizvoda	42ATV130E	
Veličina ekrana	42" dijagonala	
Proporcija širine i visine	16:9	
Napajanje	AC 100-240V~,50/60Hz	
Potrošnja struje	75W	
TV sistem	PAL B/G D/K I,SECAM B/G D/K	
Audio izlazna snaga (interna)	8Wx2	
Ulazni terminal	Antenski ulaz	x 1
	USB ulazni	x 2
	HDMI ulazni	X 3
	VGA ulazni	x 1
	PC AUDIO ulazni	x 1
	Audio ulazni ( L/R)	x 1
	Video ulazni	x 1
	YPbPr ulazni	NE
	RJ45 ulazni	NE
	Ulazni CI kartice	NE
	SCART ulazni/izlazni	NE
DC ulazni (12V)	NE	
Izlazni terminal	Slušalica	x 1
	Audio linijski izlazni (L/R)	NE
	Video izlazni	NE
	Optički	NE
	Koaksijalni izlazni	x 1
Radna temperatura	0°C~40°C	
Radna vlažnost	20% ~ 80% Bez kondenzacije	

*Beleška: Gore navedene karakteristike su podložne promeni bez upozorenja u cilju poboljšanja kvaliteta.*

# FOX LED TV

---

## 4 Podržani režimi signala

### A VGA režim

Rezolucija	Horizontalna frekvencija (Khz)	Vertikalna frekvencija (Hz)	Beleška
640 x480	31.50	60.00	
800 x600	35.16	56.25	
	37.90	60.00	
1024 x 768	48.40	60.00	
1366x 768	47.85	60.00	
1920x1080	67.50	60.00	Pun HD ploča samo

*Beleška: Savetuje se da koristite VGA kabl za povezivanje koji nije duži od 5 metara kako biste postigli odgovarajući kvalitet slike.*

### B. HDMI režim

Rezolucija	Horizontalna frekvencija (Khz)	Vertikalna frekvencija (Hz)
480p	31.468	59.94
576p	31.25	50.00
720P	45.00	60.00
1080i	33.75	60.00
1080P(1920x1080)	67.50	60.00

- Poruka upozorenja će se pojaviti na ekranu ako je signal koji ekran prima izvan dozvoljenog opsega.

-Na ekranu možete proveriti format ulaznog signala.



The terms HDMI, HDMI High-Definition Multimedia Interface, HDMI trade dress and the HDMI Logos are trademarks or registered trademarks of HDMI Licensing Administrator, Inc.

## 5 Jednostavno otklanjanje poteškoća

Ako ekran pokvari ili se njegove performanse drastično promene, proverite ekran u skladu sa smernicama u nastavku. Ne zaboravite da pregledate periferne uređaje kako biste identifikovali koren problema.

<b>Simptom</b>	<b>Rešenje</b>
Napajanje se ne može aktivirati. (Indikator napajanja ne svetli.)	-Potvrdite da su oba kraja kabla za napajanje pravilno umetnuta u utičnicu i da li je zidna utičnica funkcionalna.
Prikazuje se poruka Nema ulaznog signala.	- Proverite da li je signalna linija ispravno povezana. -Potvrdite da su relevantni periferni uređaji uključeni. -Uverite se da izabrani izbor ulaza odgovara ulaznom signalu.
Daljinski upravljač ne radi ispravno.	-Proverite da baterije nisu istrošene. (Koristite novu bateriju.) -Potvrdite da daljinski upravljač radi u svom dometu. - Uverite se da je daljinski upravljač usmeren ka prozoru daljinskog upravljača ekrana. - Uverite se da nema prepreka između daljinskog upravljača i njegovog prozora.
Na ekranu se nalaze trepćuće tačke ili pruge.	- Uverite se da nema emisija (auto, VN žice ili neonske sijalice) ili drugih potencijalnih izvora smetnji.
Boja ili kvalitet slike se pogoršavaju.	- Proverite da li su sva video podešavanja, kao što su osvetljenost, kontrast i boja, pravilno podešena. -Za dodatne informacije o video postavkama, pogledajte OSD funkcije poglavlja 2.
Položaj i veličina ekrana su netačni.	-Potvrdite da su pozicija i veličina ekrana na odgovarajući način.
Slika ili boja su netačne.	- Proverite da li je signalna linija ispravno povezana. -Kada ste povezani sa računarom, možete da promenite rezoluciju računara da biste dobili odgovarajuću sliku. Disparitet u izlaznom signalu računara može uticati na prikaz slike.
Prikažite poruku upozorenja.	- Proverite da li je ulazna linija signala na odgovarajući način obezbeđena. -Izaberite odgovarajući ulazni signal. -Pogledajte Podržani režimi signala u poglavlju 4 za dodatne



# USER MANUAL

## LED Television Model: 42ATV130E

Thank you for purchasing this device.

FOX LED televisions are known for their great performance, as for modern, functional and elegant design. Besides that, we constantly improve our customer support, we have highly efficient and wide network of services, that make our proud customers feel safe.

You made a right choice.

Now it's time for instructions, they are not complicated, but you have to follow them.



EN



**IMPORTANT SAFETY INSTRUCTIONS**

**WARNING**

- TO PREVENT FIRE OR SHOCK HAZARD, DO NOT USE AN EXTENSION CORD, RECEPTACLE OR OTHER OUTLET UNLESS THE BLADES CAN BE TO PREVENT BLADE EXPOSURE.
- TO PREVENT FIRE OR SHOCK HAZARD, DO NOT EXPOSE THIS APPLIANCE TO RAIN OR MOISTURE.

 <p>This lightning flash with arrowhead symbol in an equilateral triangle alerts users to the presence of uninsulated dangerous voltage within the products enclosure that may be of sufficient magnitude to constitute a risk of electric shock.</p>	<p><b>CAUTION</b></p> <p><b>RISK OF ELECTRIC SHOCK DO NOT OPEN</b></p> <p>Warning: To reduce the risk of electric shock, do not remove cover (or back). No user serviceable parts inside. Refer servicing to qualified service personnel.</p>	 <p>The exclamation mark within an equilateral triangle alerts users to the presence of important operating and maintenance (servicing) instructions in the literature accompanying the appliance.</p>
--	---	---

This appliance should not be exposed to water and no object filled with liquid such as a vase should be placed on the unit.

**CAUTION**

- Danger of explosion if batteries are incorrectly replaced.
- Replace with only equivalent type of battery.
- Do not expose battery to direct sunlight or any other source of heat.
- Ensure proper disposal of used batteries.
- Where the MAINS plug or an appliance coupler is used as the disconnect device, the disconnect device shall remain readily operable.
- To reduce the risk of electric shock, do not perform any servicing other than what is mentioned in the operating manual.
- There are no user-serviceable parts inside the TV; do not open the TV casing.

**IMPORTANT INFORMATION**

If a television is not positioned in a sufficiently stable location, it can be potentially hazardous due to falling. Many injuries, particularly to children, can be avoided by taking simple precautions such as:

- Using cabinets or stands recommended by the manufacturer of the television.
- Only using furniture that can safely support the television.
- Ensuring the television is not overhanging the edge of the supporting furniture.
- Not placing the television on tall furniture (for example, cupboards or bookcases) without anchoring both the furniture and the television to a suitable support.
- Not standing the televisions on cloth or other materials placed between the television and supporting furniture.
- Educating children about the dangers of climbing on furniture to reach the television or its controls.



**Safe installation**

Use the belt fixing the television to facilitate restraining the television from toping forward.



1. **Read Instructions** - All the safety and operating instructions should be read before the appliance is operated.
2. **Retain Instructions** - The safety and operating instructions should be retained for future reference.
3. **Heed Warnings** - All warnings on the appliance and in the operating instructions should be adhered to.
4. **Follow Instructions** - All operating instructions should be followed.



5. **Water and Moisture** - The appliance should not be used near water.
6. **Cart and Stands** - The appliance should only be used with a cart or stand that is recommended by the manufacturer.
7. **Wall or Ceiling Mounting** - The appliance should be mounted to a wall or ceiling only as recommended by the manufacturer.
8. **Ventilation** - The appliance should be well situated so that its location or position does not interfere with its proper ventilation.
9. **Heat** - This appliance should be placed away from heat sources such as radiators, heat registers and stoves.
10. **Power Sources** - The appliance should only be connected to a power supply as described in the operating instructions or as marked on the appliance.
11. **Grounding or Polarization** - Precautions should be taken.
12. **Power Cord Protection** - Power supply cord should be routed so that it is not likely to be walked on, pinched by items placed upon it against the cord and its end.
13. **Cleaning** - The appliance should be cleaned only as recommended by the manufacturer.
14. **Power Line** - An outdoor antenna should be located away from power lines.
15. **Outdoor Antenna Grounding** - If an outside antenna is connected to the receiver, the antenna system must be grounded so as to provide against voltages and built-up static charges.
16. **Non-use Periods** - The power cord of the appliance should be unplugged from the outlet when left unused for a long period of time.
17. **Object and Liquid Entry** - Care should be taken so that objects did not fall, and liquids are not spilled into the enclosure through openings.
18. **Conditions requiring Service** - The appliance should be serviced by qualified service personnel when:
  - The power-supply cord or the plug has been damaged.
  - Objects have fallen on or liquid has been spilled into the appliance.
  - The appliance has been exposed to rain.
  - The appliance does not appear to operate normally or exhibits a marked change in performance.
19. The ventilation should not be impeded by covering the ventilation opening with items, such as newspapers, table-cloths,curtains,etc.  
No naked flame sources, such as lighted candles, should be placed on the apparatus.  
The apparatus shall be connected to mains socket outlet with a protective earthing connection.  
The appliance coupler regard as disconnection device, the disconnect device shall remain readily operable.

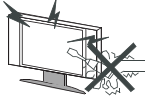

**Warning**

High voltages are used in the operating of this product. Do not remove the back cover of the cabinet. Refer servicing to qualified service personnel.

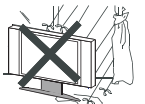

**Warning**

To prevent fire or electrical shock hazard, do not expose the main unit to rain or moisture.



**Warning**

Do not drop or push objects into television cabinet slots or openings. Never spill any kind of liquid on the television receiver.

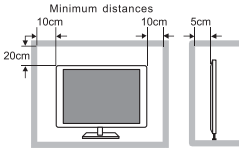

**Caution**

If the television is to be built into a compartment or similarly enclosed, the minimum distances must be maintained.

Heat built up can reduce the service life of your television, and can also be dangerous.



**Caution**

Never stand on, lean on, push suddenly the product or its stand.

You should pay special attention to children.

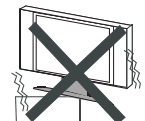

**Caution**

Do not place the main unit on an unstable cart stand, shelf or table.

Serious injury to an individual, and damage to the television, may result should it fall.

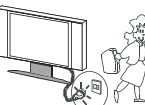

**Caution**

When the product is not used for an extended period of time, it is advisable to disconnect the AC power cord from the AC outlet.

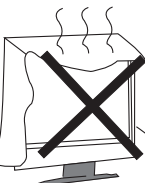

**Caution**

Avoid exposing the main unit to direct sunlight and other sources of heat. Do not position television receiver directly on other products which give off heat. E.g. Video cassette players, audio amplifiers. Do not block the ventilation holes in the back cover. Ventilation is essential to prevent electrical failure. Do not squash power supply cord under the main unit.



**Caution**

The panel used in this product is made of glass. It can break when the product is dropped or applied with force.

Individuals should execute caution when dealing with broken glass should the panel break.



- Place the TV on a firm and flat surface, leaving a space of at least 10cm around the set and 30cm from the top of the set to the wall or cabinet. Ensure the TV is positioned close to the wall to avoid it falling when pushed.

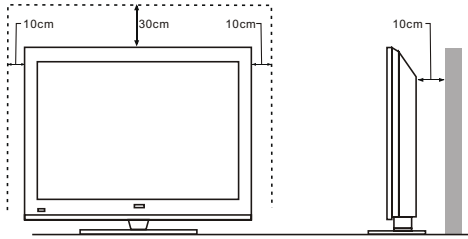

- When you turning the TV set, do not hold the top side of the TV set, you should hold the bottom side.

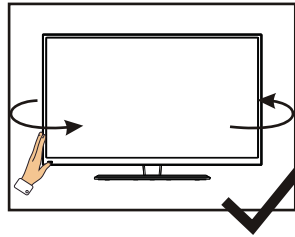
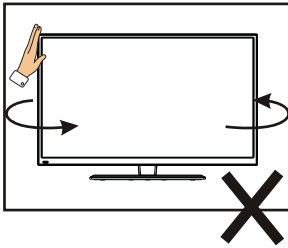

- When you lifting the TV set, do not use one hand to handle it, you should lift the TV set by two hands.

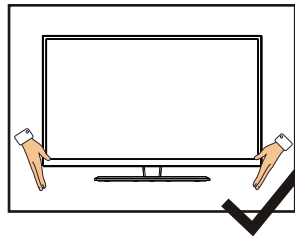
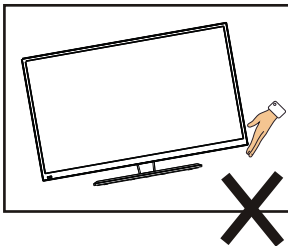

---

# CONTENTS

1. Connection and Preparation of TV.....	2
1.1 Accessories .....	2
1.2 Installation of Stand.....	2
1.3 Keys and Interfaces.....	3
1.4 Remote Control.....	4
1.5 Installation of Batteries.....	5
2. Basic Operation.....	5
2.1 Power ON/OFF(Optional).....	5
2.2 Setting of Standby Mode.....	5
2.3 Selection of Input Mode.....	5
2.4 Menu Option Adjustment.....	6
2.5 Menu Functions.....	7
2.5.1 CHANNEL Function.....	7
2.5.2 PICTURE Function.....	8
2.5.3 SOUND Function.....	9
2.5.4 TIME Function.....	10
2.5.5 OPTION Function.....	10
2.6 Screen Menu .....	11
2.7 Multimedia .....	11
2.7.1 MEDIA Function .....	11
2.7.2 USB Function.....	12
2.7.3 PHOTO.....	12
2.7.4 MUSIC.....	12
2.7.5 MOVIE.....	13
2.7.6 TEXT.....	14
3. Technical Specification.....	15
4. Supported Signal Modes.....	16
5. Simple Troubleshooting .....	17

---

# 1.Connection and Preparation of TV

## 1.1 Accessories

- ★ User Manual
- ★ Remote Control
- ★ Battery(UM-4/R03P/AAA)
- ★ Wall Mount Kit (Pre-assembled)(Optional)

## 1.2 Installation of Stand

(For the physical structure, please refer to the real object)

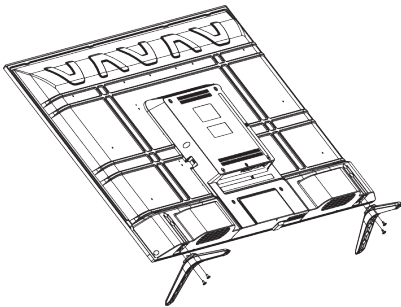

- ① Place the TV with the front panel facing downwards on the soft cloth or soft pads on a desk.
- ② Insert the stand into the bottom socket of the TV.
- ③ Insert the screws into the sockets and tighten them.

### 1.3 Keys and Interfaces

The design and specification takes actual products as the standard

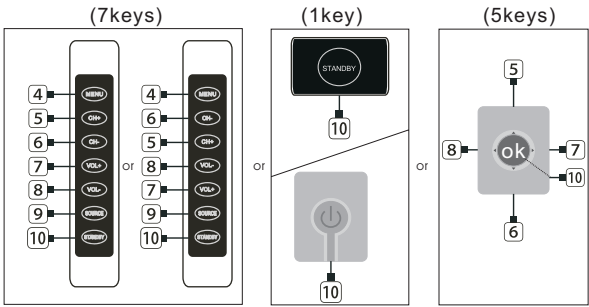
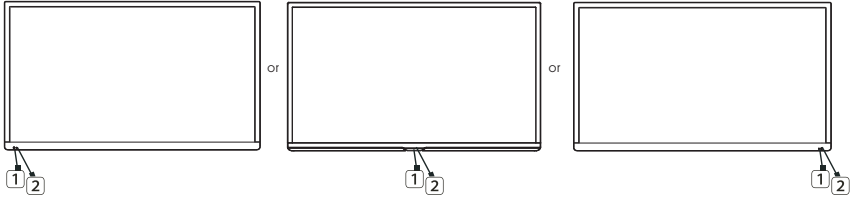

- 1. REMOTE SENSOR WINDOW
- 2. POWER INDICATOR
- 3. SPEAKER
- 4. MENU KEY
- 5. PROGRAM “+” KEY
- 6. PROGRAM “-” KEY
- 7. VOLUME “+” KEY
- 8. VOLUME “-” KEY
- 9. SOURCE KEY
- 10. STANDBYKEY
- 11. POWERPLUG INPUT

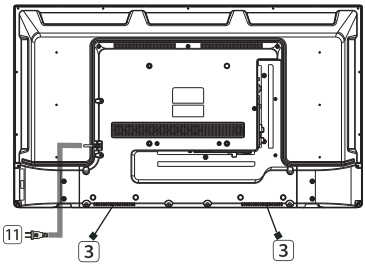

## 1.4 Remote Control

(Here is only the sketch, please in kind prevail)

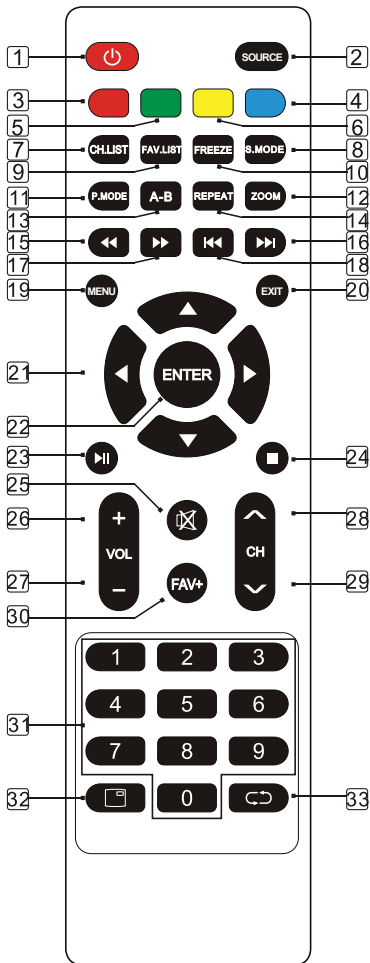

1. STANDBY: Standby turn on and off.
2. SOURCE: Select the signal source.
3. RED: Access the red item or page.
4. BLUE: Access the blue item or page.
5. GREEN: Access the green item or page.
6. YELLOW: Access the yellow item or page.
7. CH LIST: Channel list
8. S.MODE: Select the sound mode.
9. FAV.LIST: Favorite channel list
10. FREEZE: Freeze the picture.
11. P.MODE: Select the picture mode.
12. ZOOM: Zoom in or out the current picture.(Some pictures or videos may not be operated.)
13. A-B: Setup repeat play segment.
14. REPEAT: Allows you to repeat single random, shuffle and folder.
15. FB: Fast Backward
16. NEXT: Next
17. FF: Fast Forward
18. PREV.: Previous
19. MENU: Enter or exit menu.
20. EXIT: Exit menu or operation.
21. ▲,▼,◀,▶ key: The menu item selection.
22. ENTER: Confirm or enter.
23. ►|| : Press one time to pause,press again to playback.
24. ■ : Stop the playback and return to file list.
25. MUTE: Mute sound.
26. VOL+: Increase the volume.
27. VOL-: Decrease the volume.
28. CH▲:Select the channel forward.
29. CH▼:Select the channel backward.
30. FAV+: Add favorite.
31. 0~9: Continue to press the keys to select a channel.
32. DISPLAY: Display the information of current video and audio.
33. RECALL: Return to previous channel.



---

## 1.5 Installation of Batteries

(Here is only the sketch, please in kind prevail)

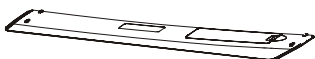
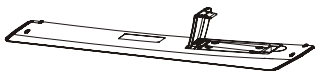

- ① Open the back lid of the remote control.
- ② Install two 7#(AAA)1.5V batteries.  
Ensure the correct polarity of the batteries.
- ③ Cover the back lid.  
Please take out of the batteries from the remote control for long time of no use.

If the remote control doesn't work properly, please carry out the following checks.

- Check the TV is turned on.
- Check the polarity of the batteries are correct.
- Check the batteries are not drained.
- Check the power supply is normal or the power cord is correctly connected.
- Check there are no special fluorescent light or neon light around.



## 2. Basic Operation

### 2.1 Power ON/OFF(Optional)

- Connect the power cord to the **AC input**. Insert the power cord into the appropriate socket.
- Press the **Power switch** to switch on the TV, then press **Power** button to turn on the unit.
- Press the **Power switch** again to switch off the TV.

Note: After switch off the TV, please don't immediately re-open the power switch ,should be delayed one minute more to re-open the power switch.

### 2.2 Setting of Standby Mode

- Press (  ) button to turn on the unit.
- Press (  ) button again to return the display to standby mode. The power indicator turns red.
- Be sure not to set your TV in standby mode for a long period of time.

### 2.3 Selection of Input Mode

This set has different signal source modes, you may continue to press the **Source** button to select a signal source.

---

When selecting the signal source, the screen will display the information.

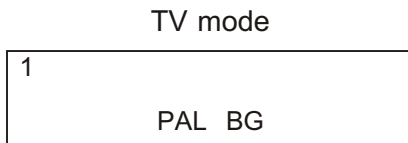

When there is no signal from the selected source, the warning message will be Displayed as per illustration. Either change the channel in TV mode or press **Source** button to change SOURCE.



## 2.4 Menu Option Adjustment

After you have installed the batteries into the remote control, you will need to set some preferences on the LED TV, using the menu system.

- The buttons for menu option adjustment include: **Menu**, **▲** , **▼** , **◀** , **▶** **Enter** buttons.
- Press the **Menu** button to open the OSD Menu, then press **◀** , **▶** button to select the pages. the pages are displayed in the following sequence (circular display):

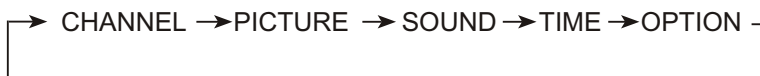

*Note: "CHANNEL" is only for TV .*

- ① Press the **Menu** button to display the menu system.
- ② Press **◀** , **▶** button to select the menu pages.
- ③ Press **▲** , **▼** button to select an item.
- ④ Press **◀** , **▶** button to selector adjust a setting.
- ⑤ If you do not make a selection within 10 seconds, the menu will close Automatically.
- ⑥ Press the **Menu** button to return or exit OSD menu.

---

## 2.5 Menu Functions

(All the initial setting of menu, please consult the actual object.  
User manual only detailedly describe how to operate the device)

### 2.5.1 CHANNEL Function

※ Adjustment of the CHANNEL

① Press the **Menu** button, and then press  
◀ or ▶ button to the "**CHANNEL**" item.

② Press ▲ or ▼ button to highlight the  
"Auto Tuning", "ATV Manual Tuning",  
"Programme Edit", then press **ENTER**  
button to change the setting.

③ Press the **Menu** button to return or exit.

※ In the "CHANNEL" menu, select "Auto  
Tuning" and then press **ENTER** button  
to auto search and store the channels.

※ In the "CHANNEL" menu, select "ATV  
Manual Tuning" and then press **ENTER**  
Button to change the setting.

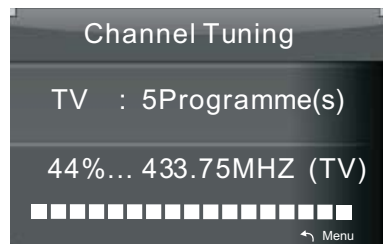
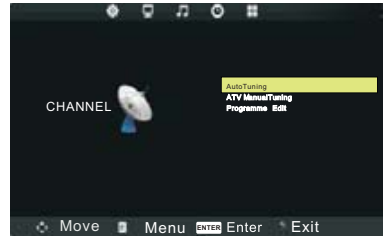

- **Current CH** Set the channel number
- **Color system** Select the color system PAL/SECAM/NTSC
- **Sound System** Select the sound system (DK/BG/M/N/I)
- **Fine-Tune** Adjust the frequency of the channel finely.
- **AFC** Automatic Fine tuning.
- **Search** Press ◀ to search down from the current frequency, and press ▶ to search up.



※ In the "CHANNEL" menu, select "Program edit" and then press **ENTER** button to change the setting.

- The four colored key is the shortcut key for programming the channel.
- First press ▲/▼ to highlight the channel you want to delete or rename or move or skip, then:
- Press the **Red** button to delete the channel.
- Press the **Green** button to enter the rename state, then press ◀/▶ to select the word you want to change, and ▲/▼ to select word.
- Press the **Yellow** button to set the channel to moving state. Then press ▲/▼ to move it to the position you want to put.
- Press the **Blue** button to skip the select channel. (Your TV set will skip the channel automatically when using CH+/- to view the channels.)
- **Fav** Add or Delete the channel to your favorite list.



## 2.5.2 PICTURE Function

※ Adjustment of the PICTURE.

- ① Press the **Menu** button, and then press ◀ or ▶ button to the "PICTURE" item.
  - ② Press ▲ or ▼ button to highlight the "Picture Mode", "Color Temperature", "Noise Reduction" item and then press **ENTER** button to enter Sub-menu.
  - ③ In Sub-menu Press ◀ or ▶ button to adjust different setting.
  - ④ Press the **Menu** button to return or exit.
- ※ In the "PICTURE" menu, select "Picture Mode" and then press **ENTER** Button to change the setting.

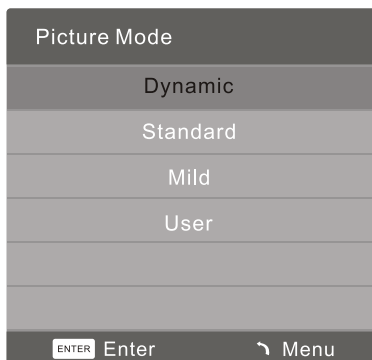
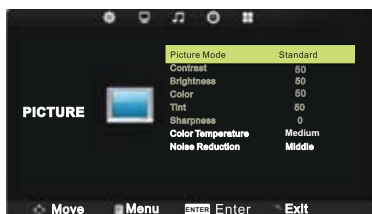

### Color Temperature

In the "PICTURE " menu,select " Color Temperature" and then press **ENTER** button to change the setting: "Cool","Medium","Warm".



### Noise Reduction

In the "PICTURE " menu,select "Noise Reduction" and then press **ENTER** button to change the setting: "Off","Low","Middle","High".

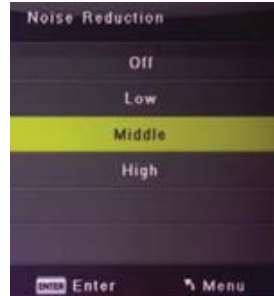

## 2.5.3 SOUND Function

※ Adjustment of the SOUND

- ① Press the **Menu** button, and then press ◀ or ▶ button to the "**SOUND**" item.
- ② Press ▲ or ▼ button to highlight the "Sound Mode", "Balance" , "Surround " "Auto Volume" , then press **ENTER** button to enter Sub-menu.
- ③ In Sub-menu Press ◀ or ▶ button to adjust different setting.
- ④ Press the **Menu** button to return or exit.

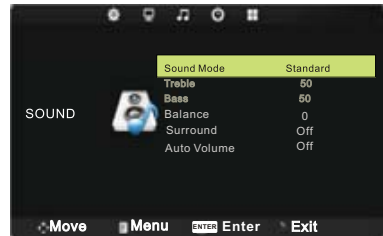

### Sound Mode

In the "SOUND " menu,select " Sound Mode " and then press ▲ or ▼ button to change the setting: "Standard","Movie", "Music","Sports","User"

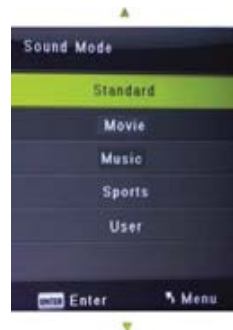

---

## 2.5.4 TIME Function

※ Adjustment of the TIME

- ① Press the Menu button, and then press ◀ or ▶ button to the "TIME" item.
- ② Press ▲ or ▼ button to highlight the "Sleep Timer", "Auto Sleep" or "OSD Timer" item and then press **ENTER** button to enter sub-menu.
- ③ In Sub-menu Press ▲ or ▼ button to adjust different setting.
- ④ Press the Menu button to return or exit.

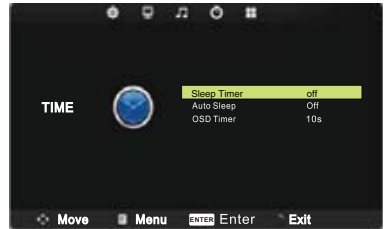

## 2.5.5 OPTION Function

※ Adjustment of the OPTION

- ① Press the **Menu** button, and then press ◀ or ▶ button to the "OPTION" item.
- ② Press ▲ or ▼ button to highlight the "OSD Language", "Aspect Ratio", "Blue Screen", "Key Lock", "HDMI CEC", "Reset", item and then press **ENTER** button to enter Sub-menu.
- ③ In Sub-menu Press ◀ or ▶ button to Adjust different setting.
- ④ Press the **Menu** button to return or exit.

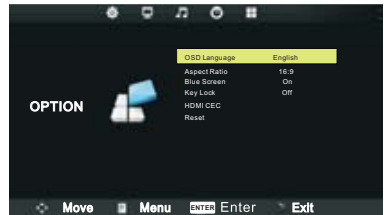

### OSD Language

In the "OPTION" menu, select "OSD Language" and then press **ENTER** button to change the setting.

### Aspect Ratio

In the "OPTION" menu, select "Aspect Ratio" and then press **ENTER** button to change the setting.

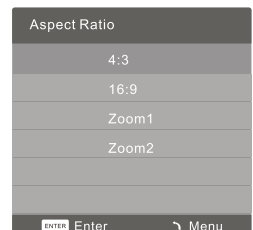

---

## 2.6 SCREEN MENU

Note:the Screen Menu is available in PC mode.Those items are set to adjust the pc screen.

Press ▲/▼ to highlight one of the following options,then press ENTER or ► to select it

**Auto Adjust** Automatically adjust Clock,Phase, H-Position, and V-Position settings.

**Horizontal Pos.** Shift the screen up or down.

**Vertical Pos.** Shift the screen left or right.

**Clock** Adjust the internal sampling clock rate.

**Phase** Adjust the internal signal phase.

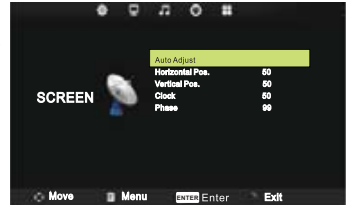

## 2.7 Multimedia

### 2.7.1 MEDIA Function

A. Support multimedia file:

Multimedia data	Format
Image	JPEG; BMP; PNG
Music	MP3
Video	MPEG-1(.DAT/.MPG) MPEG-2(.MPG/.VOB) MPEG-4(.AVI/.MP4) Digital movies
TXT	.txt

B. USB don't connect PC.

C. Compatible USB devices: The format is FAT or FAT32.

D. We cannot guarantee compatibility (operation and/or bus power) with all USB mass storage devices and assumes no responsibility for any loss of data that may occur when connected to this unit.

Please update formats for all file types (audio, photo, video)

---

## 2.7.2 USB Function

### ✕ Adjustment of the USB

- ① Press the SOURCE button, and then press ▲ or ▼ button to highlight the “MEDIA” item and then press ENTER button.
- ② Press ◀ or ▶ button to highlight the “PHOTO”, “MUSIC”, “MOVIE”, “TEXT” item and then press ENTER button.
- ③ Press the SOURCE button to return or exit.

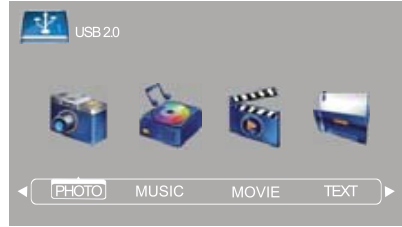

## 2.7.3 PHOTO

- A. Press ◀ or ▶ to select folder or file, press **ENTER** button to enter next folder, press **RECALL** to return previous folder.
- B. Press ◀ or ▶ to select the **PHOTO** that you want, press **ENTER** button to select playlist than press ▶| button to play.
- C. Press **Display** button to the media item.
- D. Press ◀ or ▶ button to highlight the media and then press **ENTER** button.

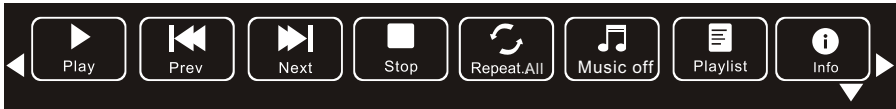

Play/pause Previous, Next, Stop, Repeat ALL, Music Off, Playlist, Info. .

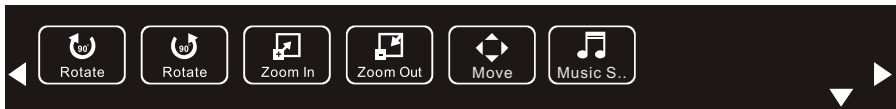

Rotate, Rotate, Zoom In, Zoom Out, Move View, Music Source.

## 2.7.4 MUSIC

- A. Press ◀ or ▶ to select folder or file, press **ENTER** button to enter next folder, press **RECALL** to return previous folder.
- B. Press ◀ or ▶ to select the **MUSIC** that you want, press **ENTER** button to select playlist than press ▶| button to play.
- C. Press **Display** button to the media item.
- D. Press ◀ or ▶ button to highlight the media and then press **ENTER** button



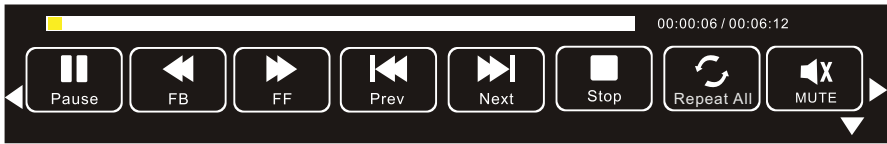

Play/pause Fast Backward, Fast Forward, Previous, Next, Stop, Repeat ALL, MUTE.

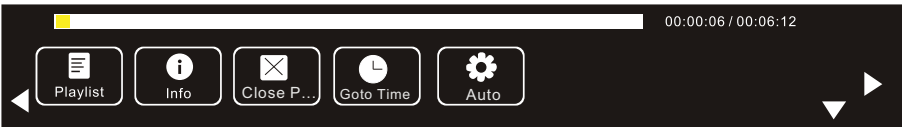

Playlist, Info, Close Panel, Goto Time, Auto.

## 2.7.5 MOVIE

- A. Press ◀ or ▶ to select folder or file, press **ENTER** button to enter next folder , press **RECALL** to return previous folder.
- B. Press ◀ or ▶ to select the **MOVIE** that you want, press **ENTER** button to select playlist than press ▶ button to play.
- C. Press Display button to the media item.
- D. Press ◀ or ▶ button to highlight the media and then press **ENTER** button

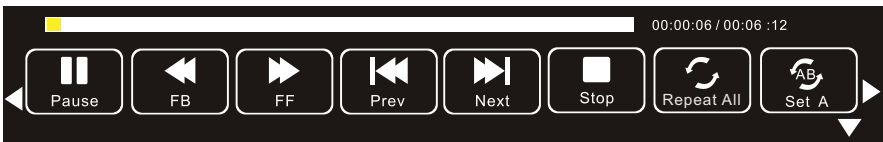

Play/pause, Fast Backward, Fast Forward, Previous, Next, Stop, Repeat ALL, Set A/B

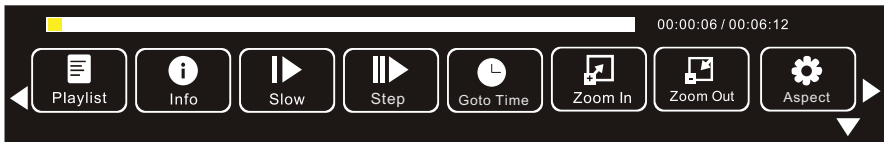

Playlist, Info, Slow Fw, Step Fw, Goto Time, Zoom In, Zoom Out, Aspect Ratio



Auto, Move View.

---

## 2.7.6 TEXT

- A. Press ◀ or ▶ to select folder or file, press **ENTER** button to enter next folder, press **RECALL** to return previous folder.
- B. Press ◀ or ▶ to select the **TEXT** that you want, press **ENTER** button to select playlist than press ▶ button to play.
- C. Press **Display** button to the media item.
- D. Press ◀ or ▶ button to highlight the media and then press **ENTER** button

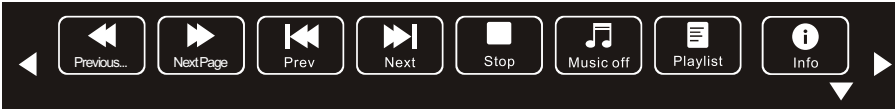

Previous Page, Next Page, Previous, Next, Stop, Music Off, Playlist, Info



Music Source, Auto.

### 3. Technical Specification

Product Model	42ATV130E	
Screen Size	42" diagonal	
Aspect Ratio	16:9	
Power Supply	AC 100-240V~,50/60Hz	
Power Consumption	75W	
TV System	PAL B/G D/K I, SECAM B/G D/K	
Audio Output Power (Internal)	8Wx2	
Input Terminal	Antenna Input	x 1
	USB Input	x 2
	HDMI Input	x 3
	VGA Input	x 1
	PC AUDIO Input	x 1
	Audio Input (L/R)	x 1
	Video Input	x 1
	YPbPr Input	NO
	RJ45 Input	NO
	CI card In	NO
	SCART In/Output	NO
	DC In (12V)	NO
Output Terminal	Earphone	x 1
	Audio Line Out(L/R)	NO
	Video Output	NO
	Optical	NO
	Coaxial out	x 1
Working Temperature	0°C~40°C	
Working Humidity	20% ~ 80% Non-condensing	

*Note: the specification shown above may change without notice for quality improvement.*

---

## 4. Supported Signal Modes

### A.VGA Mode

Resolution	Horizontal Frequency (Khz)	Vertical Frequency (Hz)	Memo
640 x 480	31.50	60.00	
800 x 600	35.16	56.25	
	37.90	60.00	
1024 x 768	48.40	60.00	
1366x 768	47.85	60.00	
1920x 1080	67.50	60.00	Full HD panel only

*Note: You' re suggested to use the VGA connecting cord of not more than 5 meters to ensure the appropriate picture quality.*

### B.HDMI Mode

Resolution	Horizontal Frequency (Khz)	Vertical Frequency (Hz)
480p	31.468	59.94
576p	31.25	50.00
720P	45.00	60.00
1080i	33.75	60.00
1080P(1920x1080)	67.50	60.00

*-When the signal received by the Display exceeds the allowed range, a warning message will appear on the screen.*

*-You can confirm the input signal format onscreen.*

---

## 5. Simple Troubleshooting

If the display fails or the performance changes dramatically, check the display in accordance with the following instructions. Remember to check the peripherals to pinpoint the source of the failure.

Symptom	Solution
Power cannot be turned on.(Power indicator does not light.)	-Check that both ends of the power cable are plugged into the socket appropriately and the wall socket is operational
No Input Signal message appears.	-Check that the signal line is connected properly. -Check that the power of the relevant peripherals is turned on. -Check that the Input option that has been selected matches with the input signal.
The remote control does not function properly.	-Check the batteries are not drained.(Use new batteries.) -Check that the remote control is within the operating range. -Check that the remote control is pointed to the remote control window on the display. -Check that there are no obstacles between the remote control and the remote control window.
Flashing spots or stripes appear on the screen.	-Check that there are no emission (Car, HV cable or Neon lamp) or other possible interference sources.
Image colour or quality deteriorates.	-Check that all the video settings are adjusted appropriately, such as brightness, contrast, colour etc. -For more information about video settings, refer to OSD Functions in Chapter 2.
Screen position and size are incorrect.	-Check that the screen position and size is adjusted appropriately.
Image or colour is incorrect.	-Check that the signal line is connected properly. -When connecting to a PC, you can change the resolution of the PC to acquire the correct image. The discrepancy of the PC output signal may affect the display of the image.
Display warning message.	-Check that the input signal line is properly fixed. -Select the correct input signal. -For more information, refer to Supported Signal Modes in Chapter 4.



Nadamo se da ste pažljivo pročitali uputstva i da ćete ih se pridržavati. Za više informacija o FOX uređajima posetite našu internet stranicu:

**[www.foxelectronics.rs](http://www.foxelectronics.rs)**

Ovaj dokument je originalno proizveden i objavljen od strane proizvođača, brenda FOX, i preuzet je sa njihove zvanične stranice. S obzirom na ovu činjenicu, Tehnoteka ističe da ne preuzima odgovornost za tačnost, celovitost ili pouzdanost informacija, podataka, mišljenja, saveta ili izjava sadržanih u ovom dokumentu.

Napominjemo da Tehnoteka nema ovlašćenje da izvrši bilo kakve izmene ili dopune na ovom dokumentu, stoga nismo odgovorni za eventualne greške, propuste ili netačnosti koje se mogu naći unutar njega. Tehnoteka ne odgovara za štetu nanесenu korisnicima pri upotrebi netačnih podataka. Ukoliko imate dodatna pitanja o proizvodu, ljubazno vas molimo da kontaktirate direktno proizvođača kako biste dobili sve detaljne informacije.

Za najnovije informacije o ceni, dostupnim akcijama i tehničkim karakteristikama proizvoda koji se pominje u ovom dokumentu, molimo posetite našu stranicu klikom na sledeći link:

<https://tehnoteka.rs/p/fox-televizor-42atv130e-akcija-cena/>