

Uputstvo za upotrebu (EN)

DELL laptop Vostro 3535 (NOT22361)



Tehnoteka je online destinacija za upoređivanje cena i karakteristika bele tehnike, potrošačke elektronike i IT uređaja kod trgovinskih lanaca i internet prodavnica u Srbiji. Naša stranica vam omogućava da istražite najnovije informacije, detaljne karakteristike i konkurentne cene proizvoda.

Posetite nas i uživajte u ekskluzivnom iskustvu pametne kupovine klikom na link:

<https://tehnoteka.rs/p/dell-laptop-vostro-3535-not22361-akcija-cena/>

Vostro 15 3535

Owner's Manual

Notes, cautions, and warnings

 **NOTE:** A NOTE indicates important information that helps you make better use of your product.

 **CAUTION:** A CAUTION indicates either potential damage to hardware or loss of data and tells you how to avoid the problem.

 **WARNING:** A WARNING indicates a potential for property damage, personal injury, or death.

Chapter 1: Views of Vostro 15 3535	7
Right	7
Left	7
Top	8
Front	9
Bottom	11
Using the privacy shutter	11
Service Tag	12
Battery charge and status light	13
Chapter 2: Set up your Vostro 15 3535	14
Chapter 3: Specifications of Vostro 15 3535	16
Dimensions and weight	16
Processor	16
Chipset	17
Operating system	17
Memory	17
External ports	18
Internal slots	18
Ethernet	18
Wireless module	19
Audio	19
Storage	20
Keyboard	20
Keyboard shortcuts of Vostro 15 3535	21
Camera	22
Touchpad	23
Power adapter	23
Battery	24
Display	25
Fingerprint reader (optional)	25
GPU—Integrated	26
GPU—Discrete	26
Multiple display support matrix	26
Hardware security	26
Operating and storage environment	27
ComfortView	27
Color, material, and finish	28
Chapter 4: Working inside your computer	31
Safety instructions	31
Before working inside your computer	31
Safety precautions	32

Electrostatic discharge—ESD protection.....	32
ESD field service kit	33
Transporting sensitive components.....	34
After working inside your computer.....	34
BitLocker.....	34
Recommended tools.....	34
Screw list.....	34
Major components of Vostro 15 3535.....	36

Chapter 5: Removing and installing Customer Replaceable Units (CRUs)..... 39

Secure Digital (SD) Card.....	39
Removing the Secure Digital card.....	39
Installing the Secure Digital card.....	40
Base cover.....	40
Removing the base cover.....	40
Installing the base cover.....	44
Memory modules.....	46
Removing the memory modules.....	46
Installing the memory modules.....	47
M.2 solid-state drive.....	48
Removing the M.2 2230 solid state drive.....	48
Installing the M.2 2230 solid state drive.....	49
Removing the M.2 2280 solid state drive.....	51
Installing the M.2 2280 solid state drive.....	52
Wireless card.....	53
Removing the wireless card.....	53
Installing the wireless card.....	54
Fan.....	56
Removing the fan.....	56
Installing the fan.....	57
Speakers.....	58
Removing the speakers.....	58
Installing the speakers.....	60

Chapter 6: Removing and installing Field Replaceable Units (FRUs)..... 63

Battery.....	63
Lithium-ion battery precautions.....	63
Removing the 3-cell battery.....	63
Installing the 3-cell battery.....	64
Removing the 4-cell battery.....	65
Installing the 4-cell battery.....	67
Disconnecting the battery cable.....	68
Connecting the battery cable.....	69
Touchpad.....	70
Removing the touchpad.....	70
Installing the touchpad.....	72
Heat sink.....	74
Removing the UMA heat sink	74
Installing the UMA heat sink	75

Removing the discrete heat sink.....	75
Installing the discrete heat sink	76
I/O daughter board FFC.....	77
Removing the Input/Output daughter board FFC.....	77
Installing the Input/Output daughter board FFC.....	79
I/O board.....	80
Removing the Input/Output board.....	80
Installing the Input/Output board.....	81
Display assembly.....	82
Removing the display assembly.....	82
Installing the display assembly.....	86
Hinge caps.....	90
Removing the hinge caps.....	90
Installing the hinge caps	92
Display bezel.....	94
Removing the display bezel.....	94
Installing the display bezel	97
Hinges.....	99
Removing the hinges.....	99
Installing the hinges	101
Display panel.....	103
Removing the display panel.....	103
Installing the display panel.....	109
eDP cable.....	113
Removing the eDP cable.....	113
Installing the eDP cable.....	114
Camera assembly.....	116
Removing the camera module.....	116
Installing the camera module.....	117
Display cover and antenna assembly.....	118
Replacement of the display cover and antenna assembly.....	118
Power-adapter port.....	119
Removing the power-adapter port.....	119
Installing the power-adapter port.....	120
Power-button board.....	121
Removing the power button.....	121
Installing the power button.....	122
Power button with optional fingerprint reader.....	123
Removing the power button with optional fingerprint reader.....	123
Installing the power button with optional fingerprint reader.....	124
System board.....	125
Removing the system board.....	125
Installing the system board.....	128
Palm-rest and keyboard assembly.....	131
Removing the palm-rest and keyboard assembly.....	131
Installing the palmrest and keyboard assembly.....	133
Chapter 7: Software.....	137
Operating system.....	137
Drivers and downloads.....	137

Chapter 8: BIOS setup	138
Entering BIOS setup program.....	138
Navigation keys.....	138
One time boot menu.....	138
System setup options.....	139
Updating the BIOS.....	143
Updating the BIOS in Windows.....	143
Updating the BIOS using the USB drive in Windows.....	144
Updating the BIOS in Linux and Ubuntu.....	144
Updating the BIOS from the F12 One Time Boot menu.....	144
System and setup password.....	145
Assigning a system setup password.....	145
Deleting or changing an existing system setup password.....	145
Clearing BIOS (System Setup) and System passwords.....	146
Chapter 9: Troubleshooting	147
Handling swollen Lithium-ion batteries.....	147
Locate the Service Tag or Express Service Code of your Dell computer	147
Dell SupportAssist Pre-boot System Performance Check diagnostics.....	148
Running the SupportAssist Pre-Boot System Performance Check.....	148
Built-in self-test (BIST).....	148
M-BIST.....	148
LCD Power rail test (L-BIST).....	149
LCD Built-in Self Test (BIST).....	149
System-diagnostic lights.....	150
Recovering the operating system.....	151
Real-Time Clock (RTC Reset).....	152
Backup media and recovery options.....	152
Wi-Fi power cycle.....	152
Drain residual flea power (perform hard reset).....	152
Chapter 10: Getting help and contacting Dell	154

Views of Vostro 15 3535

Right



1. SD-card slot

Reads from and writes to the SD card. The computer supports the following card types:

- Secure Digital (SD)
- Secure Digital High Capacity (SDHC)
- Secure Digital Extended Capacity (SDXC)

2. USB 2.0 port

Connect devices such as external storage devices and printers. Provides data transfer speeds up to 480 Mbps.

3. Network port

Connect an Ethernet (RJ45) cable from a router or a broadband modem for network or Internet access, with a transfer rate of 10/100/1000 Mbps.

4. Global headset jack

Connect headphones or a headset (headphone and microphone combo).

5. Security-cable slot (wedge-shaped)

Connect a security cable to prevent unauthorized movement of your computer.

Left



1. Power-adaptor port

Connect a power adaptor to provide power to your computer and charge the battery.

2. Power-status light

Indicates the power state of the computer.

White light—Power adaptor is connected and the battery is fully charged.

3. HDMI 1.4 port

Connect to a TV, external display or another HDMI-in enabled device. Provides video and audio output.

4. USB 3.2 Gen 1 port

Connect devices such as external storage devices and printers. Provides data transfer speeds up to 5 Gbps.

5. USB 3.2 Gen 1 (Type-C) port

Connect to external storage devices. Provides data transfer speeds up to 5 Gbps.

NOTE: This port does not support video/audio streaming.

Top

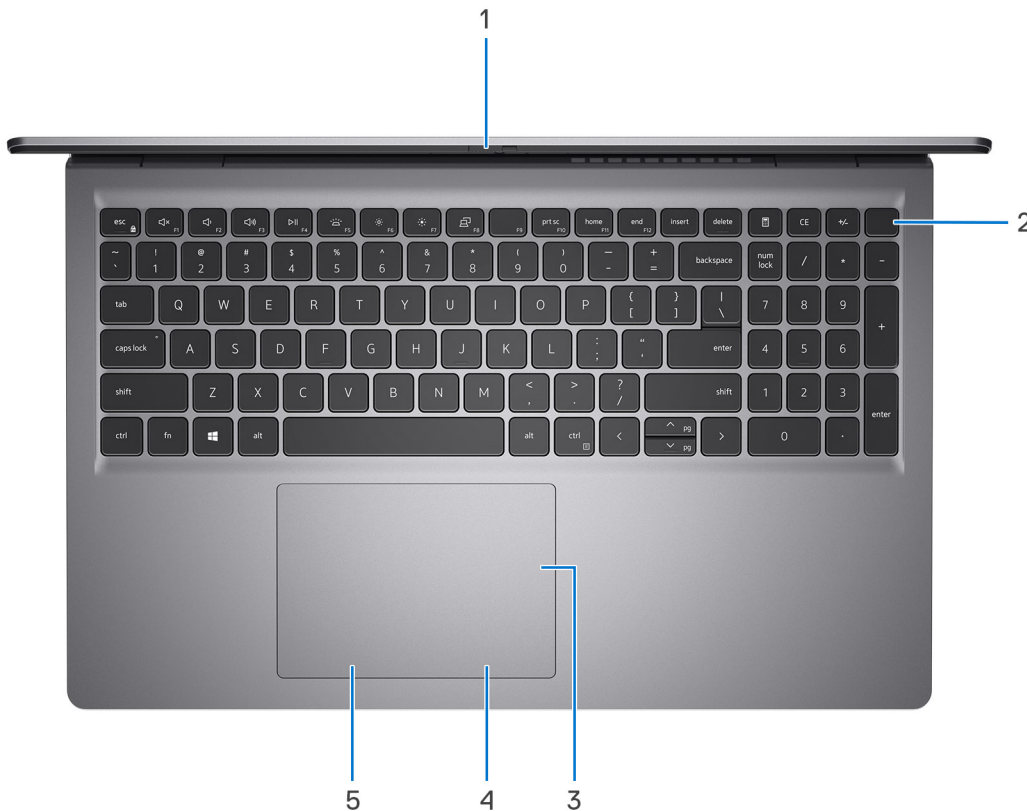

1. Privacy shutter

Slide the privacy shutter to cover the camera lens and protect your privacy when the camera is not in use.

NOTE: Privacy shutter is only available on upsell configurations with aluminum chassis.

2. Power button with optional fingerprint reader

Press to turn on the computer if it is turned off, in sleep state, or in hibernate state.

When the computer is turned on, press the power button to put the computer into sleep state; press and hold the power button for four seconds to force shut-down the computer.

If the power button has a fingerprint reader, place your finger on the power button to log in.

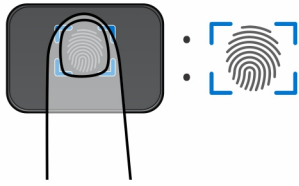

NOTE: The highlighted area indicates the actual active fingerprint reader area and the image is for illustration purposes only.

NOTE: You can customize power-button behavior in Windows.

3. Precision touchpad

Move your finger on the touchpad to move the mouse pointer. Tap to left-click and two fingers tap to right-click.

4. Touchpad right-click area

Press to right-click.

5. Touchpad left-click area

Press to left-click.

Front

CAUTION: The maximum operating angle for the display-panel hinge is 135 degrees.

NOTE: Vostro 15 3535 is built in two designs: Plastic and aluminum

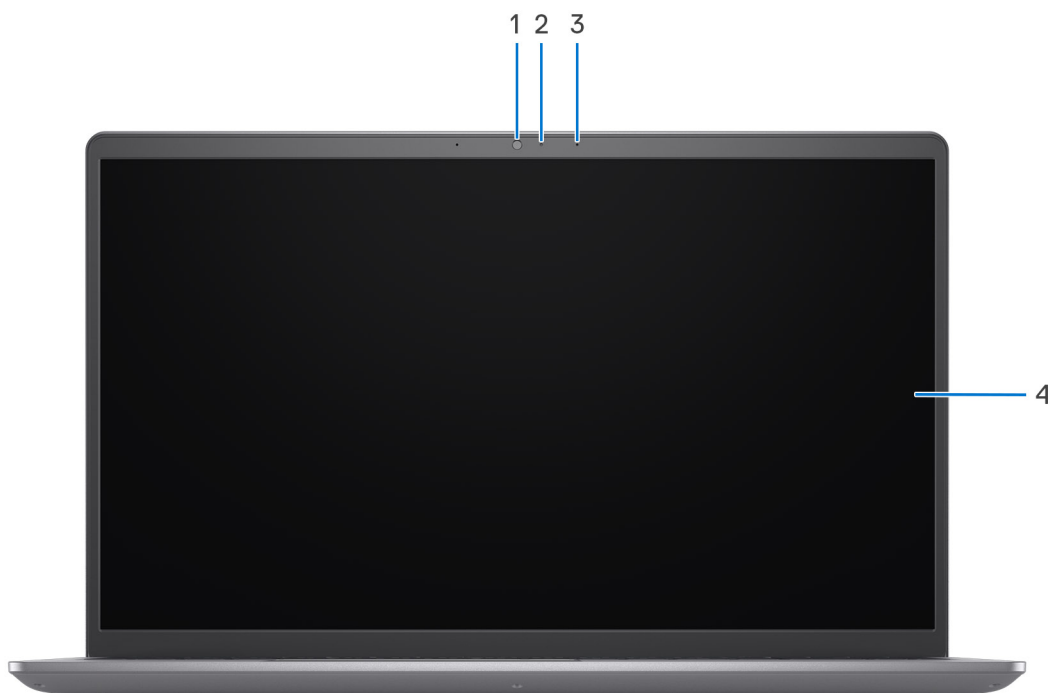

Figure 1. Plastic chassis without privacy shutter

- 1. Camera**
Enables you to video chat, capture photos, and record videos.
- 2. Camera-status light**
Turns on when the camera is in use.
- 3. Microphone**
Provides digital sound input for audio recording and voice calls.
- 4. LCD panel**
Provides visual output to the user.

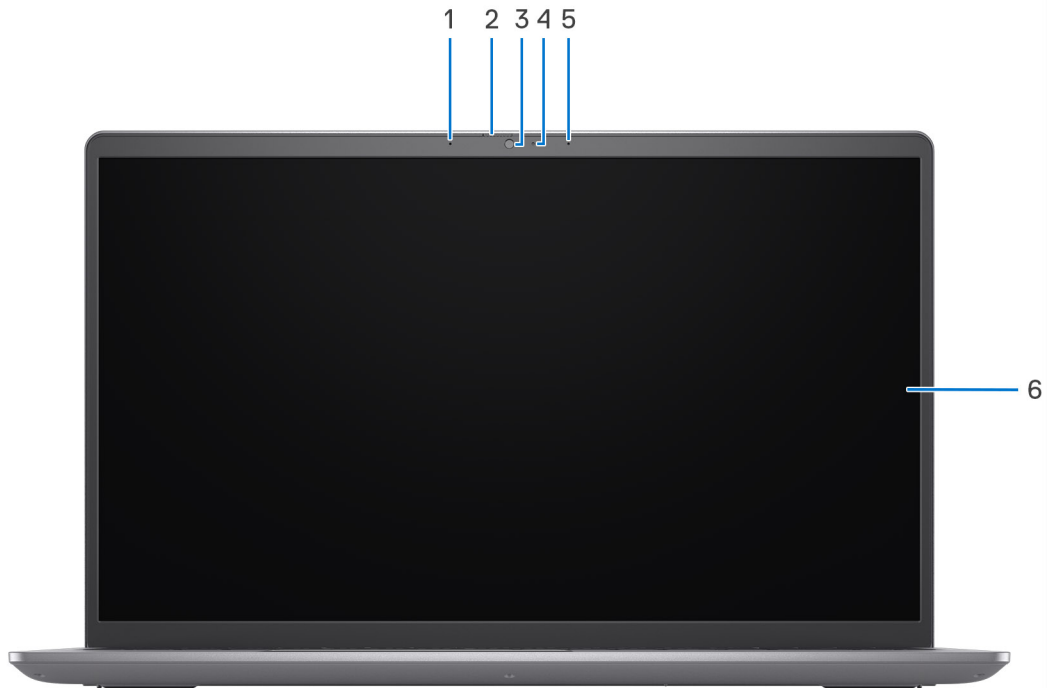
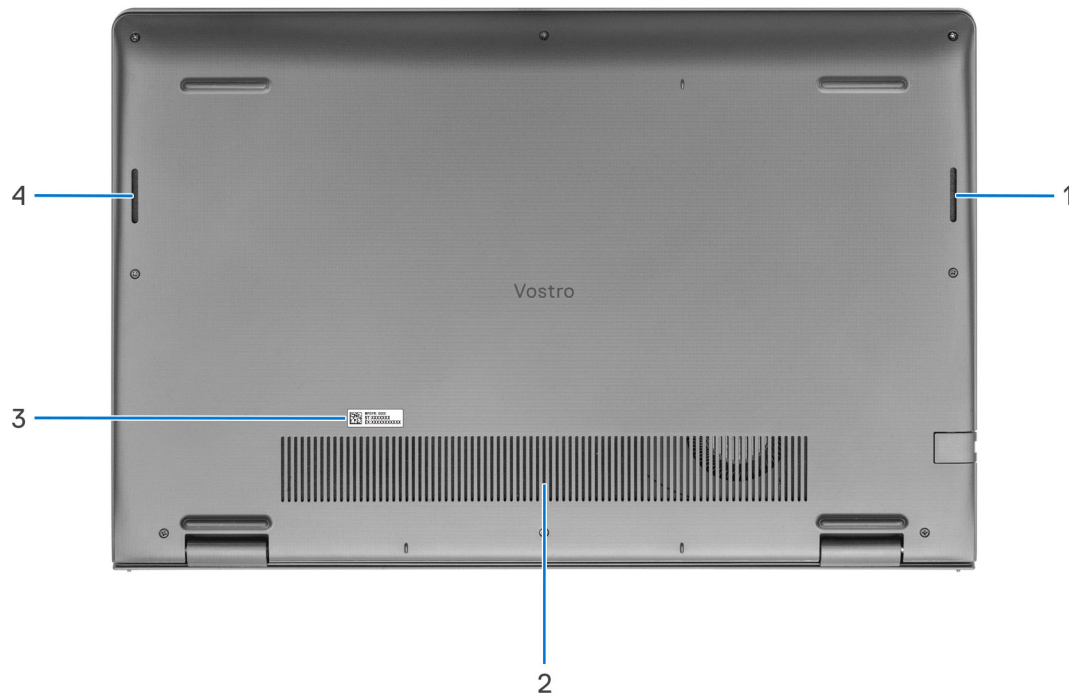

Figure 2. Aluminum chassis with privacy shutter

- 1. Left microphone**
Provides digital sound input for audio recording and voice calls.
- 2. Privacy shutter**
Slide the privacy shutter to cover the camera lens and protect your privacy when the camera is not in use.
- 3. Camera**
Enables you to video chat, capture photos, and record videos.
- 4. Camera-status light**
Turns on when the camera is in use.
- 5. Right microphone**
Provides digital sound input for audio recording and voice calls.
- 6. LCD panel**
Provides visual output to the user.

Bottom



1. Right speaker

Provides audio output.

2. Air vents

Air vents provide ventilation for your computer. Clogged air vents can cause overheating and can affect your computer's performance and potentially cause hardware issues. Keep the air vents clear of obstructions and clean them regularly to prevent build-up of dust and dirt. For more information about cleaning air vents, search for articles in Knowledge Base Resource at www.dell.com/support.

3. Service Tag and regulatory labels

The Service Tag is a unique alphanumeric identifier that enables Dell service technicians to identify the hardware components in your computer and access warranty information. The regulatory label contains regulatory information of your computer.

4. Left speaker

Provides audio output.

Using the privacy shutter

1. Slide the privacy shutter to the left to access the camera lens.
2. Slide the privacy shutter to the right to cover the camera lens.

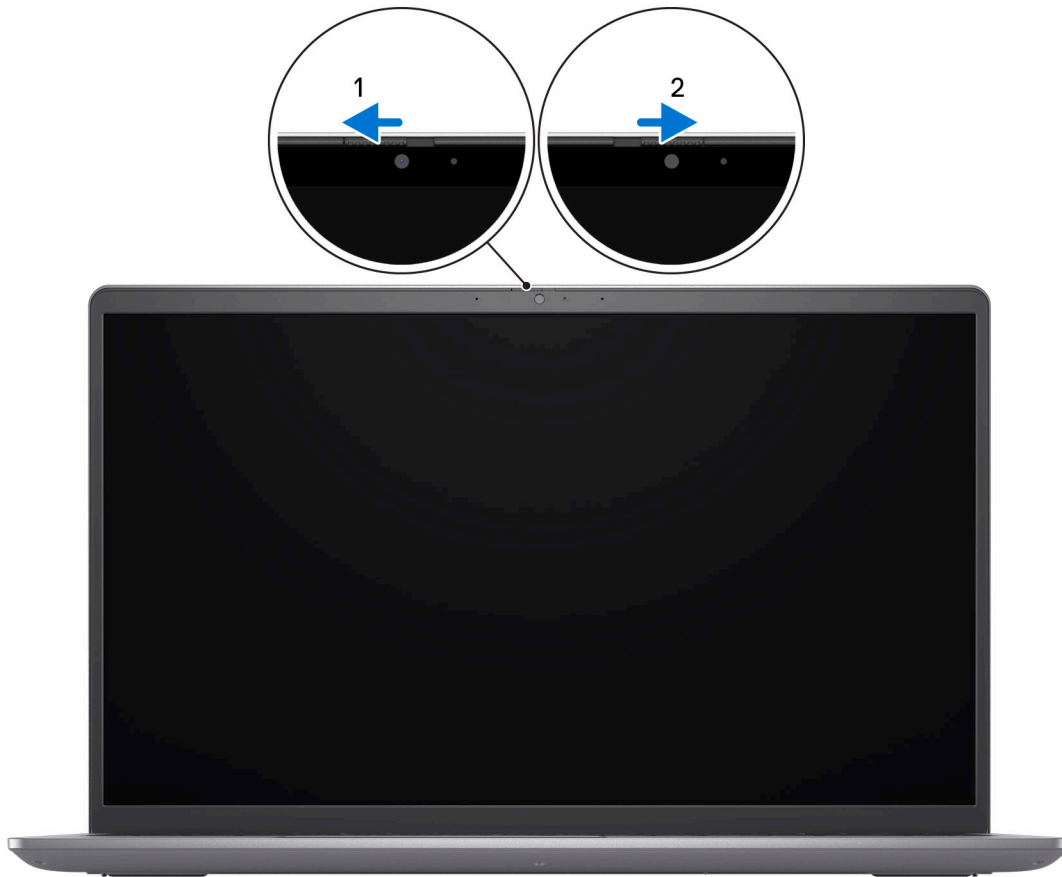

Service Tag

The service tag is a unique alphanumeric identifier that allows Dell service technicians to identify the hardware components in your computer and access warranty information.



Battery charge and status light

The following table lists the battery charge and status light behavior of your Vostro 15 3535.

Table 1. Battery charge and status light behavior

Power Source	LED Behavior	System Power State	Battery Charge Level
AC Adapter	Off	S0 - S5	Fully Charged
AC Adapter	Solid White	S0 - S5	< Fully Charged
Battery	Off	S0 - S5	11-100%
Battery	Solid Amber (590+/-3 nm)	S0 - S5	< 10%

- S0 (ON) - System is turned on.
- S4 (Hibernate) - The system consumes the least power compared to all other sleep states. The system is almost at an OFF state, expect for a trickle power. The context data is written to storage device.
- S5 (OFF) - The system is in a shutdown state.

Set up your Vostro 15 3535

About this task

NOTE: The images in this document may differ from your computer depending on the configuration you ordered.

Steps

1. Connect the power adapter and press the power button.



NOTE: To conserve battery power, the battery might enter power saving mode. Connect the power adapter and press the power button to turn on the computer.

2. Finish operating system setup.

For Ubuntu:

Follow the on-screen instructions to complete the setup. For more information about installing and configuring Ubuntu, search in the Knowledge Base Resource at www.dell.com/support.

For Windows:

Follow the on-screen instructions to complete the setup. When setting up, Dell recommends that you:







- Connect to a network for Windows updates.

NOTE: If connecting to a secured wireless network, enter the password for the wireless network access when prompted.

- If connected to the internet, sign-in with or create a Microsoft account. If not connected to the internet, create an offline account.
- On the **Support and Protection** screen, enter your contact details.

3. Locate and use Dell apps from the Windows Start menu—Recommended.

Table 2. Locate Dell apps

Resources	Description
	<p>Dell Product Registration Register your computer with Dell.</p>
	<p>Dell Help & Support Access help and support for your computer.</p>
	<p>My Dell Centralized location for key Dell applications, help articles, and other important information about your computer. It also notifies you about the warranty status, recommended accessories, and software updates if available.</p>
	<p>SupportAssist SupportAssist is the smart technology that keeps your computer running at its best by optimizing settings, detecting issues, removing viruses and notifies when you need to make system updates. SupportAssist proactively checks the health of your system's hardware and software. When an issue is detected, the necessary system state information is sent to Dell to begin troubleshooting. SupportAssist is preinstalled on most of the Dell devices running Windows operating system. For more information, see SupportAssist for Home PCs User's Guide on www.dell.com/serviceabilitytools.</p> <p>NOTE: In SupportAssist, click the warranty expiry date to renew or upgrade your warranty.</p>
	<p>Dell Update Updates your computer with critical fixes and latest device drivers as they become available. For more information on using Dell Update, search in the Knowledge Base Resource at www.dell.com/support.</p>
	<p>Dell Digital Delivery Download software applications, which are purchased but not preinstalled on your computer. For more information on using Dell Digital Delivery, search in the Knowledge Base Resource at www.dell.com/support.</p>

Specifications of Vostro 15 3535

Dimensions and weight

The following table lists the height, width, depth, and weight of your Vostro 15 3535.

Table 3. Dimensions and weight

Description	Plastic	Aluminum
Height:		
Front height	16.96 mm (0.67 in.)	15.52 mm (0.61 in.)
Rear height	18.99 mm (0.75 in.)	17.50 mm (0.69 in.)
Width	358.50 mm (14.11 in.)	358.50 mm (14.11 in.)
Depth	235.60 mm (9.27 in.)	234.90 mm (9.25 in.)
Weight  NOTE: The weight of your computer depends on the configuration ordered and manufacturing variability.	Minimum: 1.67 kg (3.68 lb)	Minimum: 1.68 kg (3.70 lb)

Processor

The following table lists the details of the processors supported by your Vostro 15 3535.

Table 4. Processor

Description	Option one	Option two	Option three	Option four	Option five	Option six
Processor type	AMD Athlon Gold 7220U	AMD Ryzen3 7320U	AMD Ryzen3 7330U	AMD Ryzen5 7520U	AMD Ryzen5 7530U	AMD Ryzen7 7730U
Processor wattage	15 W	15 W	15 W	15 W	15 W	15 W
Processor core count	2	4	4	4	6	8
Processor thread count	4	8	8	8	12	16
Processor speed	2.40 GHz to 3.70 GHz	2.40 GHz to 4.10 GHz	2.30 GHz to 4.30 GHz	2.80 GHz to 4.30 GHz	2 GHz to 4.50 GHz	2 GHz to 4.50 GHz
Processor cache	5 MB	6 MB	10 MB	6 MB	19 MB	20 MB
Integrated graphics	AMD Radeon Graphics	AMD Radeon Graphics	AMD Radeon Graphics	AMD Radeon Graphics	AMD Radeon Graphics	AMD Radeon Graphics

Chipset

The following table lists the details of the chipset supported by your Vostro 15 3535

Table 5. Chipset

Description	Option one	Option two
Processors	AMD Athlon series	AMD Ryzen series
Chipset	Integrated	Integrated
DRAM bus width	64-bit	64-bit
Flash EPROM	16 MB	16 MB
PCIe bus	Up to Gen3	Up to Gen3

Operating system

Your Vostro 15 3535 supports the following operating systems:

- Windows 11 Home, 64-bit
- Windows 11 Pro, 64-bit
- Windows 11 Pro National Academic, 64-bit
- Ubuntu Linux 22.04 LTS, 64-bit

Memory

The following table lists the memory specifications of your Vostro 15 3535.

Table 6. Memory specifications

Description	Values
Memory slots	Two-SoDIMM slots
Memory type	<ul style="list-style-type: none">• DDR4• LPDDR5• LPDDR5x
Memory speed	<ul style="list-style-type: none">• 3200 MHz (for DDR4)• 5500 MHz (for LPDDR5/LPDDR5x)
Maximum memory configuration	16 GB
Minimum memory configuration	4 GB
Memory size per slot	4 GB, 8 GB, 16 GB
Memory configurations supported	<ul style="list-style-type: none">• 4 GB, 1 x 4 GB, DDR4, 3200 MHz• 8 GB, 1 x 8 GB, DDR4, 3200 MHz• 8 GB, 2 x 4 GB, DDR4, 3200 MHz, dual-channel• 12 GB, 1 x 4 GB + 1 x 8 GB, DDR4, 3200 MHz, dual-channel• 16 GB, 1 x 16 GB, DDR4, 3200 MHz• 16 GB, 2 x 8 GB, DDR4, 3200 MHz, dual-channel <p>NOTE:</p>

Table 6. Memory specifications (continued)

Description	Values
	For AMD Athlon Gold 7220U, AMD Ryzen3 7320U and AMD Ryzen5 7520U: <ul style="list-style-type: none"> • 8 GB, 1 x 8 GB, LPDDR5, 5500 MHz • 8 GB, 1 x 8 GB, LPDDR5x, 5500 MHz

External ports

The following table lists the external ports of your Vostro 15 3535.

Table 7. External ports

Description	Values
Network port	One RJ-45 Ethernet Port 10/100/1000 Mbps
USB ports	<ul style="list-style-type: none"> • One USB 3.2 Gen 1 port • One USB 3.2 Gen 1 Type-C port • One USB 2.0 port
Audio port	One headset (headphone and microphone combo) port
Video port	One HDMI 1.4 port
Media-card reader	One SD-card slot
Power-adaptor port	65 W AC adapter, 4.5 mm barrel
Security-cable slot	One wedge-shaped lock slot

Internal slots

The following table lists the internal slots of your Vostro 15 3535.

Table 8. Internal slots

Description	Values
M.2	<ul style="list-style-type: none"> • One M.2 2230 slot for WiFi and Bluetooth combo card • One M.2 2230/2280 slot for solid-state drive <p>NOTE: To learn more about the features of different types of M.2 cards, search in the Knowledge Base Resource at www.dell.com/support.</p>

Ethernet

The following table lists the wired Ethernet Local Area Network (LAN) specifications of your Vostro 15 3535.

Table 9. Ethernet specifications

Description	Values
Model number	Integrated Realtek RTL8111H

Table 9. Ethernet specifications (continued)

Description	Values
Transfer rate	10/100/1000 Mbps Mbps

Wireless module

The following table lists the Wireless Local Area Network (WLAN) modules supported on your Vostro 15 3535.

Table 10. Wireless module specifications

Description	Option one	Option two
Model number	Realtek RTL8821CE	Realtek RTL8852BE
Transfer rate	433 Mbps	1201 Mbps
Frequency bands supported	2.4 GHz/5 GHz	2.4 GHz/5 GHz
Wireless standards	<ul style="list-style-type: none"> • Wi-Fi 802.11 a/b/g • Wi-Fi 4 (WiFi 802.11n) • Wi-Fi 5 (WiFi 802.11ac) 	<ul style="list-style-type: none"> • Wi-Fi 802.11 a/b/g • Wi-Fi 4 (WiFi 802.11n) • Wi-Fi 5 (WiFi 802.11ac) • Wi-Fi 6 (WiFi 802.11ax)
Encryption	<ul style="list-style-type: none"> • 64-bit/128-bit WEP • AES-CCMP • TKIP 	<ul style="list-style-type: none"> • 64-bit/128-bit WEP • AES-CCMP • TKIP
Bluetooth	Bluetooth 5.0	Bluetooth 5.3  NOTE: Particular versions of Microsoft Windows may not support the full Bluetooth 5.3 functionality.

Audio

The following table lists the audio specifications of your Vostro 15 3535.

Table 11. Audio specifications

Description	Mendocino	Barcelo-R
Audio controller	Realtek ALC3204	Realtek ALC3254
Stereo conversion	Supported	Supported
Internal audio interface	High definition audio interface	High definition audio interface
External audio interface	One headset (headphone and microphone combo) port	One headset (headphone and microphone combo) port
Number of speakers	Two	Two
Internal-speaker amplifier	Supported	Supported (Audio codec built-in amplifier)
External volume controls	Keyboard shortcut controls	Keyboard shortcut controls
Speaker output:		

Table 11. Audio specifications (continued)

Description		Mendocino	Barcelo-R
	Average speaker output	2 W	2 W
	Peak speaker output	2.5 W	2.5 W
Subwoofer output		Not supported	Not supported
Microphone		Single digital microphone	Plastic: Single digital microphone Aluminum: Dual-array microphones

Storage

This section lists the storage options on your Vostro 15 3535.

Your Vostro 15 3535 supports one of the following storage configurations:

- One M.2 2230/2280 solid-state drive

Table 12. Storage specifications

Storage type	Interface type	Capacity
M.2 2230 solid-state drive	PCIe NVMe	Up to 1 TB
M.2 2280 solid-state drive	PCIe NVMe	Up to 2 TB

Keyboard

The following table lists the keyboard specifications of your Vostro 15 3535.

Table 13. Keyboard specifications

Description	Values
Keyboard type	<ul style="list-style-type: none"> • Carbon black, backlit • Carbon black, non-backlit
Keyboard layout	QWERTY
Number of keys	<ul style="list-style-type: none"> • United States and Canada: 99 keys • United Kingdom: 100 keys • Japan: 103 keys
Keyboard size	X=18.70 mm key pitch Y=18.05 mm key pitch
Keyboard shortcuts	<p>Some keys on your keyboard have two symbols on them. These keys can be used to type alternate characters or to perform secondary functions. To type the alternate character, press Shift and the desired key. To perform secondary functions, press Fn and the desired key.</p> <p>NOTE: You can define the primary behavior of the function keys (F1–F12) changing Function Key Behavior in BIOS setup program.</p> <p>For more information, see Keyboard shortcuts.</p>

Keyboard shortcuts of Vostro 15 3535

NOTE: Keyboard characters may differ depending on the keyboard language configuration. Keys used for shortcuts remain the same across all language configurations.

Some keys on your keyboard have two symbols on them. These keys can be used to type alternate characters or to perform secondary functions. The symbol shown on the lower part of the key refers to the character that is typed out when the key is pressed. If you press shift and the key, the symbol shown on the upper part of the key is typed out. For example, if you press **2**, **2** is typed out; if you press **Shift + 2**, **@** is typed out.

The keys F1-F12 at the top row of the keyboard are function keys for multi-media control, as indicated by the icon at the bottom of the key. Press the function key to invoke the task represented by the icon. For example, pressing F1 mutes the audio (refer to the table below).

However, if the function keys F1-F12 are needed for specific software applications, multi-media functionality can be disabled by pressing **Fn + Esc**. Subsequently, multi-media control can be invoked by pressing **Fn** and the respective function key. For example, mute audio by pressing **Fn + F1**.

NOTE: You can also define the primary behavior of the function keys (F1–F12) by changing **Function Key Behavior** in BIOS setup program.

Table 14. List of keyboard shortcuts

Function key	Primary behavior
F1	Mute audio
F2	Decrease volume
F3	Increase volume
F4	Play/Pause
F5	Toggle keyboard backlight (optional)
F6	Decrease brightness
F7	Increase brightness
F8	Switch to external display
F10	Print screen
F11	Home
F12	End

The **Fn** key is also used with selected keys on the keyboard to invoke other secondary functions.

Table 15. Secondary behavior

Function key	Secondary behavior
Fn + F1	Operating system and application specific F1 behavior
Fn + F2	Operating system and application specific F2 behavior
Fn + F3	Operating system and application specific F3 behavior
Fn + F4	Operating system and application specific F4 behavior
Fn + F5	Operating system and application specific F5 behavior
Fn + F6	Operating system and application specific F6 behavior
Fn + F7	Operating system and application specific F7 behavior
Fn + F8	Operating system and application specific F8 behavior
Fn + F9	Operating system and application specific F9 behavior
Fn + F10	Operating system and application specific F10 behavior

Table 15. Secondary behavior (continued)

Function key	Secondary behavior
Fn + F11	Operating system and application specific F11 behavior
Fn + F12	Operating system and application specific F12 behavior
Fn + PrtScr	Turn off/on wireless
Fn + B	Pause/Break
Fn + Insert	Sleep
Fn + S	Toggle scroll lock
Fn + H	Toggle between power and battery-status light/hard-drive activity light
Fn + R	System request
Fn + Ctrl	Open application menu
Fn + Esc	Toggle Fn-key lock
Fn + PgUp	Page up
Fn + PgDn	Page down
Fn + Home	Home
Fn + End	End

Camera

The following table lists the camera specifications of your Vostro 15 3535.

Table 16. Camera specifications

Description	Carbon Black/Titan Gray (Plastic)	Titan Gray (Aluminum)
Number of cameras	One	One
Camera type	RGB HD camera	FHD RGB camera
Camera location	Front	Front Camera
Camera sensor type	CMOS sensor technology	CMOS sensor technology
Camera resolution:		
Still image	0.92 megapixel	2 Megapixel
Video	1280 x 720 (HD) at 30 fps	1920 x 1080 (FHD) at 30 fps
Diagonal viewing angle:	78.6 degrees	82 degrees

Touchpad

The following table lists the touchpad specifications of your Vostro 15 3535.

Table 17. Touchpad specifications

Description		Values
Touchpad resolution:		
	Horizontal	> 300
	Vertical	> 300
Touchpad dimensions:		
	Horizontal	115 mm (4.53 in.)
	Vertical	80 mm (3.15 in.)
Touchpad gestures		For more information about touchpad gestures available on Windows, see the Microsoft knowledge base article at support.microsoft.com .

Power adapter

The following table lists the power adapter specifications of your Vostro 15 3535.

Table 18. Power adapter specifications

Description		Values
Type		65 W AC Adapter, 4.50 mm x 2.90 mm barrel type
Connector dimensions:		
	External diameter	4.50 mm (0.18 in.)
	Internal diameter	2.90 mm (0.11 in.)
Power-adapter dimensions:		
	Height	28.00 mm (1.10 in.)
	Width	108.00 mm (4.30 in.)
	Depth	47.00 mm (1.90 in.)
Power-adapter weight (maximum)		0.29 kg (0.64 lb)
Input voltage		100 VAC–240 VAC
Input frequency		50 Hz – 60 Hz
Input current (maximum)		1.60 A / 1.7 A
Output current (continuous)		3.34 A
Rated output voltage		19.50 VDC
Temperature range:		



Table 18. Power adapter specifications (continued)

Description		Values
	Operating	0°C to 40°C (32°F to 104°F)
	Storage	-40°C to 70°C (-40°F to 158°F)
 CAUTION: Operating and storage temperature ranges may differ among components, so operating or storing the device outside these ranges may impact the performance of specific components.		

Battery

The following table lists the battery specifications of your Vostro 15 3535.

Table 19. Battery specifications

Description	Option one	Option two	
Battery type	3-cell polymer 41 Wh	4-cell polymer 54 Wh	
Battery voltage	11.25 VDC	15 VDC	
Battery weight (maximum)	0.176 kg (0.388 lb)	0.231 kg (0.509 lb)	
Battery dimensions:			
	Height	206.4 mm (8.13 in.)	271.9 mm (10.71 in.)
	Width	82 mm (3.23 in.)	82 mm (3.23 in.)
	Depth	5.75 mm (0.23 in.)	5.75 mm (0.23 in.)
Temperature range:			
	Operating	0°C to 35°C (32°F to 95°F)	0°C to 35°C (32°F to 95°F)
	Storage	-40°C to 65°C (-40°F to 149°F)	-40°C to 65°C (-40°F to 149°F)
Battery operating time	Varies depending on operating conditions and can significantly reduce under certain power-intensive conditions.	Varies depending on operating conditions and can significantly reduce under certain power-intensive conditions.	
Battery charging time (approximate)  NOTE: Control the charging time, duration, start and end time, and so on using the Dell Power Manager application. For more information about Dell Power Manager, search in the Knowledge Base Resource at www.dell.com/support .	4 Hours hours (when the computer is off)	4 Hours hours (when the computer is off)	
Coin-cell battery	N/A	N/A	
 CAUTION: Operating and storage temperature ranges may differ among components, so operating or storing the device outside these ranges may impact the performance of specific components.			
 CAUTION: Dell recommends that you charge the battery regularly for optimal power consumption. If your battery charge is completely depleted, connect the power adapter, turn on your computer, and then restart your computer to reduce the power consumption.			

Display

The following table lists the display specifications of your Vostro 15 3535.

Table 20. Display specifications

Description		Option one	Option two
Display type		15.0 in. High Definition (HD)	15.0 in. Full HD (FHD)
Touch options		No	No
Display-panel technology		Twisted Nematic (TN)	In-Plane Switching (IPS)
Display-panel dimensions (active area):			
	Height	193.54 mm (7.62 in.)	193.54 mm (7.62 in.)
	Width	344.23 mm (13.60 in.)	344.23 mm (13.60 in.)
	Diagonal	394.90 mm (15.50 in.)	394.90 mm (15.50 in.)
Display-panel native resolution		1366 x 768	1920 x 1200
Luminance (typical)		220 nits	250 nits
Megapixels		1.05 M	2.1 M
Color gamut		NTSC 45%	NTSC 45%
Pixels Per Inch (PPI)		100	141
Contrast ratio (min.)		300:1	600:1
Response time (max.)		21 ms	35 ms
Refresh rate		60 Hz	120 Hz
Horizontal view angle		40 degrees (Left/Right)	80 degrees (Left/Right)
Vertical view angle		10 degrees (Up) / 30 degrees (Down)	80 degrees (Up/Down)
Pixel pitch		0.252 x 0.252 mm	0.17925 x 0.17925 mm
Power consumption (maximum)		4.20 W	4.55 W
Anti-glare vs glossy finish		Anti-glare	Anti-glare

Fingerprint reader (optional)

The following table lists the specifications of the optional fingerprint-reader of your Vostro 15 3535.

Table 21. Fingerprint reader specifications

Description	Values
Fingerprint-reader sensor technology	Capacitive
Fingerprint-reader sensor resolution	500 dpi

Table 21. Fingerprint reader specifications (continued)

Description	Values
Fingerprint-reader sensor pixel size	108 x 88

GPU—Integrated

The following table lists the specifications of the integrated Graphics Processing Unit (GPU) supported by your Vostro 15 3535.

Table 22. GPU—Integrated

Controller	Memory size	Processor
AMD Radeon Graphics	Shared system memory	Athlon Gold/Ryzen 3/Ryzen 5/Ryzen 7

GPU—Discrete

The following table lists the specifications of the discrete Graphics Processing Unit (GPU) supported by your Vostro 15 3535.

Table 23. GPU—Discrete

Controller	Memory size	Memory type
NVIDIA GeForce MX550 (upsell)	2 GB	GDDR6

Multiple display support matrix

The following table lists the multiple display support matrix for your Vostro 15 3535.

Table 24. Multiple display support matrix

Graphics Card	Direct Graphics Controller Direct Output Mode	Supported external displays with computer internal display on	Supported external displays with computer internal display off
AMD Radeon Graphics	Not supported	1	1
NVIDIA GeForce MX550 (upsell)	Supported	1	1

Hardware security

The following table lists the hardware security of your Vostro 15 3535.

Table 25. Hardware security

Hardware security
Windows 10 Hello - Fingerprint Reader (optional)
Trusted Platform Module (TPM) 2.0
Camera shutter (for metal laptop only)
One wedge-shaped lock slot

Operating and storage environment

This table lists the operating and storage specifications of your Vostro 15 3535.

Airborne contaminant level: G1 as defined by ISA-S71.04-1985

Table 26. Computer environment

Description	Operating	Storage
Temperature range	0°C to 35°C (32°F to 95°F)	-40°C to 65°C (-40°F to 149°F)
Relative humidity (maximum)	10% to 90% (non-condensing)	0% to 95% (non-condensing)
Vibration (maximum)*	0.66 GRMS	1.30 GRMS
Shock (maximum)	110 G†	160 G†
Altitude range	-15.2 m to 3048 m (-49.87 ft to 10000 ft)	-15.2 m to 10668 m (-49.87 ft to 35000 ft)
 CAUTION: Operating and storage temperature ranges may differ among components, so operating or storing the device outside these ranges may impact the performance of specific components.		

* Measured using a random vibration spectrum that simulates user environment.

† Measured using a 2 ms half-sine pulse.

ComfortView

 **WARNING: Prolonged exposure to blue light from the display may lead to long-term effects such as eye strain, eye fatigue, or damage to the eyes.**

Blue light is a color in the light spectrum which has a short wavelength and high energy. Chronic exposure to blue light, particularly from digital sources, may disrupt sleep patterns and cause long-term effects such as eye strain, eye fatigue, or damage to the eyes.

ComfortView mode can be enabled and configured using the Dell CinemaColor application.

ComfortView mode complies with TÜV Rheinland's requirement for low blue light displays.

Low blue light: Dell ComfortView software technology reduces harmful blue light emissions to make extended screen time easy on your eyes.

To reduce the risk of eye strain, it is also recommended that you:

- Position the display at a comfortable viewing distance between 20 and 28 inches (50 and 70 cm) from your eyes.
- Blink frequently to moisten your eyes, wet your eyes with water, or apply suitable eye drops.
- Look away from your display, and gaze at a distant object at 20 ft (609.60 cm) away for at least 20 seconds during each break.
- Take an extended break for 20 minutes every two hours.

Color, material, and finish

This section details the color, material, and finish (CMF) specifications of your Vostro 15 3535.



Titan Gray

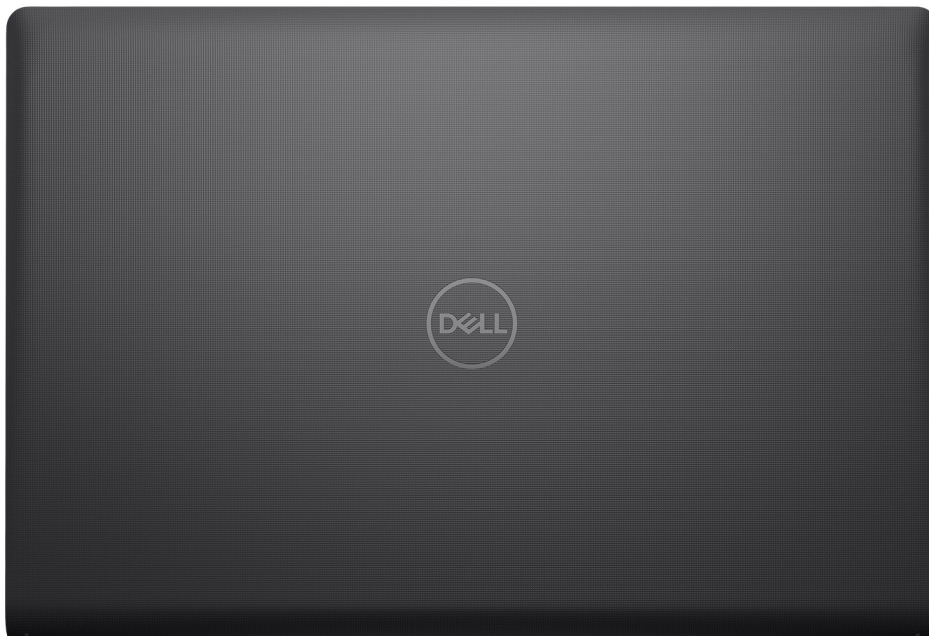

Carbon Black

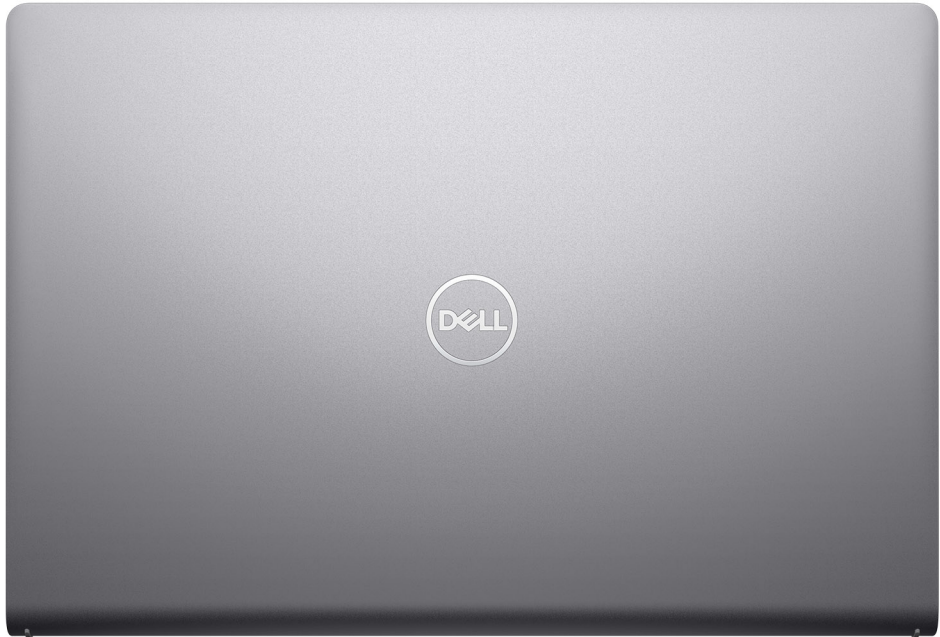

Titan Gray Aluminum

Table 27. CMF specifications

A Cover (Top)	<ul style="list-style-type: none"> • Plastic Resin/ Molded + Micro Pattern and Polished (Baseline) / Molded + Polished + Paint (Upsell) • Apollo, Resin (Baseline), Titan Gray, Dull (Upsell) • Baseline – Micro Pattern XL L5109 and Fine Texture COL001216 / 3.5 ±1 gu • Upsell – 10 ± 2gu 	<ul style="list-style-type: none"> • Aluminum/Stamping + CNC + Bead blast + Anodize *<0.5R hard EDGE • Anodized Titan Gray, Bead blast • 11 ± 3 gu
B Cover (Hinge up)	<ul style="list-style-type: none"> • Plastic Resin • Apollo COL001214 	<ul style="list-style-type: none"> • Plastic Resin • Color Match to D cover
C Cover (Palmrest)	<ul style="list-style-type: none"> • Plastic, Resin • Baseline - As molded + Micro Pattern and polished Upsell - Molded + Polished + Paint (WUVM)+ Printing • Apollo, Resin (Baseline), Titan Gray, Dull (Upsell) • Baseline - Micro Pattern XL L5109 and Fine Texture COL001216, 3.5 ± 1 gu I/O Icon - Concaved Polished #1200 Upsell -10 ± 2 gu , I/O Icon Printing Matte 	<ul style="list-style-type: none"> • Plastic, Resin • Molded + Polished + Paint + Printing • Baseline - Apollo Upsell - Titan Gray, Dull • 10 ± 2 gu, I/O Icon Printing Matte
D Cover (Bottom)	<ul style="list-style-type: none"> • Plastic Resin + 30% PCR 	<ul style="list-style-type: none"> • Plastic Resin + 30% PCR

Table 27. CMF specifications (continued)

	<ul style="list-style-type: none"> ● Molded + Micro Pattern & Polished ● Baseline - Apollo, Resin Upsell - Titan Gray, Resin ● Micro Pattern XL L5109 and Fine Texture COL001216, 3.5 ± 1 gu, Sub Brand - Concaved Polished #5000 	<ul style="list-style-type: none"> ● Molded + Polished + Paint + Printing ● Baseline - Apollo Upsell - Titan Gray ● 10 ± 2 gu, subbrand Printing Matte
--	--	---











i **NOTE:** Titan Gray, Dull – Cool Gray 9C = RGB 117 120 123 HEX/HTML 75787B CMYK 30 22 17 57

i **NOTE:** Apollo –19-4205 TPG RGB 64 65 69 HEX/HTML 404145 CMYK NA

Working inside your computer

Safety instructions

Use the following safety guidelines to protect your computer from potential damage and to ensure your personal safety. Unless otherwise noted, each procedure included in this document assumes that you have read the safety information that shipped with your computer.

-  **WARNING:** Before working inside your computer, read the safety information that is shipped with your computer. For more safety best practices, see the Regulatory Compliance home page at www.dell.com/regulatory_compliance.
-  **WARNING:** Disconnect your computer from all power sources before opening the computer cover or panels. After you finish working inside the computer, replace all covers, panels, and screws before connecting your computer to an electrical outlet.
-  **CAUTION:** To avoid damaging the computer, ensure that the work surface is flat, dry, and clean.
-  **CAUTION:** To avoid damaging the components and cards, handle them by their edges, and avoid touching the pins and the contacts.
-  **CAUTION:** You should only perform troubleshooting and repairs as authorized or directed by the Dell technical assistance team. Damage due to servicing that is not authorized by Dell is not covered by your warranty. See the safety instructions that is shipped with the product or at www.dell.com/regulatory_compliance.
-  **CAUTION:** Before touching anything inside your computer, ground yourself by touching an unpainted metal surface, such as the metal at the back of the computer. While you work, periodically touch an unpainted metal surface to dissipate static electricity which could harm internal components.
-  **CAUTION:** When you disconnect a cable, pull it by its connector or its pull tab, not the cable itself. Some cables have connectors with locking tabs or thumbscrews that you must disengage before disconnecting the cable. When disconnecting cables, keep them evenly aligned to avoid bending the connector pins. When connecting cables, ensure that the ports and the connectors are correctly oriented and aligned.
-  **CAUTION:** Press and eject any installed card from the media-card reader.
-  **CAUTION:** Exercise caution when handling Lithium-ion batteries in laptops. Swollen batteries should not be used and should be replaced and disposed properly.
-  **NOTE:** The color of your computer and certain components may appear differently than shown in this document.

Before working inside your computer

About this task

-  **NOTE:** The images in this document may differ from your computer depending on the configuration you ordered.

Steps

1. Save and close all open files and exit all open applications.
2. Shut down your computer. For Windows operating system, click **Start** >  **Power** > **Shut down**.

 **NOTE:** If you are using a different operating system, see the documentation of your operating system for shut-down instructions.

3. Disconnect your computer and all attached devices from their electrical outlets.
4. Disconnect all attached network devices and peripherals, such as keyboard, mouse, and monitor from your computer.

 **CAUTION:** To disconnect a network cable, first unplug the cable from your computer and then unplug the cable from the network device.

5. Remove any media card and optical disc from your computer, if applicable.

Safety precautions

The safety precautions chapter details the primary steps to be taken before performing any disassembly instructions.

Observe the following safety precautions before you perform any installation or break/fix procedures involving disassembly or reassembly:

- Turn off the system and all attached peripherals.
- Disconnect the system and all attached peripherals from AC power.
- Disconnect all network cables, telephone, and telecommunications lines from the system.
- Use an ESD field service kit when working inside any to avoid electrostatic discharge (ESD) damage.
- After removing any system component, carefully place the removed component on an anti-static mat.
- Wear shoes with non-conductive rubber soles to reduce the chance of getting electrocuted.

Standby power

Dell products with standby power must be unplugged before you open the case. Systems that incorporate standby power are essentially powered while turned off. The internal power enables the system to be remotely turned on (wake on LAN) and suspended into a sleep mode and has other advanced power management features.

Unplugging, pressing, and holding the power button for 15 seconds should discharge residual power in the system board.

Bonding

Bonding is a method for connecting two or more grounding conductors to the same electrical potential. This is done through the use of a field service electrostatic discharge (ESD) kit. When connecting a bonding wire, ensure that it is connected to bare metal and never to a painted or non-metal surface. The wrist strap should be secure and in full contact with your skin, and ensure that you remove all jewelry such as watches, bracelets, or rings prior to bonding yourself and the equipment.

Electrostatic discharge—ESD protection

ESD is a major concern when you handle electronic components, especially sensitive components such as expansion cards, processors, memory DIMMs, and system boards. Very slight charges can damage circuits in ways that may not be obvious, such as intermittent problems or a shortened product life span. As the industry pushes for lower power requirements and increased density, ESD protection is an increasing concern.

Due to the increased density of semiconductors used in recent Dell products, the sensitivity to static damage is now higher than in previous Dell products. For this reason, some previously approved methods of handling parts are no longer applicable.

Two recognized types of ESD damage are catastrophic and intermittent failures.

- **Catastrophic** – Catastrophic failures represent approximately 20 percent of ESD-related failures. The damage causes an immediate and complete loss of device functionality. An example of catastrophic failure is a memory DIMM that has received a static shock and immediately generates a "No POST/No Video" symptom with a beep code emitted for missing or nonfunctional memory.
- **Intermittent** – Intermittent failures represent approximately 80 percent of ESD-related failures. The high rate of intermittent failures means that most of the time when damage occurs, it is not immediately recognizable. The DIMM receives a static shock, but the tracing is merely weakened and does not immediately produce outward symptoms related to the damage. The weakened trace may take weeks or months to melt, and in the meantime may cause degradation of memory integrity, intermittent memory errors, etc.

The more difficult type of damage to recognize and troubleshoot is the intermittent (also called latent or "walking wounded") failure.

Perform the following steps to prevent ESD damage:

- Use a wired ESD wrist strap that is properly grounded. The use of wireless anti-static straps is no longer allowed; they do not provide adequate protection. Touching the chassis before handling parts does not ensure adequate ESD protection on parts with increased sensitivity to ESD damage.
- Handle all static-sensitive components in a static-safe area. If possible, use anti-static floor pads and workbench pads.
- When unpacking a static-sensitive component from its shipping carton, do not remove the component from the anti-static packing material until you are ready to install the component. Before unwrapping the anti-static packaging, ensure that you discharge static electricity from your body.
- Before transporting a static-sensitive component, place it in an anti-static container or packaging.

ESD field service kit

The unmonitored Field Service kit is the most commonly used service kit. Each Field Service kit includes three main components: anti-static mat, wrist strap, and bonding wire.

Components of an ESD field service kit

The components of an ESD field service kit are:

- **Anti-Static Mat** – The anti-static mat is dissipative and parts can be placed on it during service procedures. When using an anti-static mat, your wrist strap should be snug and the bonding wire should be connected to the mat and to any bare metal on the system being worked on. Once deployed properly, service parts can be removed from the ESD bag and placed directly on the mat. ESD-sensitive items are safe in your hand, on the ESD mat, in the system, or inside a bag.
- **Wrist Strap and Bonding Wire** – The wrist strap and bonding wire can be either directly connected between your wrist and bare metal on the hardware if the ESD mat is not required, or connected to the anti-static mat to protect hardware that is temporarily placed on the mat. The physical connection of the wrist strap and bonding wire between your skin, the ESD mat, and the hardware is known as bonding. Use only Field Service kits with a wrist strap, mat, and bonding wire. Never use wireless wrist straps. Always be aware that the internal wires of a wrist strap are prone to damage from normal wear and tear, and must be checked regularly with a wrist strap tester in order to avoid accidental ESD hardware damage. It is recommended to test the wrist strap and bonding wire at least once per week.
- **ESD Wrist Strap Tester** – The wires inside of an ESD strap are prone to damage over time. When using an unmonitored kit, it is a best practice to regularly test the strap prior to each service call, and at a minimum, test once per week. A wrist strap tester is the best method for doing this test. If you do not have your own wrist strap tester, check with your regional office to find out if they have one. To perform the test, plug the wrist-strap's bonding-wire into the tester while it is strapped to your wrist and push the button to test. A green LED is lit if the test is successful; a red LED is lit and an alarm sounds if the test fails.
- **Insulator Elements** – It is critical to keep ESD sensitive devices, such as plastic heat sink casings, away from internal parts that are insulators and often highly charged.
- **Working Environment** – Before deploying the ESD Field Service kit, assess the situation at the customer location. For example, deploying the kit for a server environment is different than for a desktop or portable environment. Servers are typically installed in a rack within a data center; desktops or portables are typically placed on office desks or cubicles. Always look for a large open flat work area that is free of clutter and large enough to deploy the ESD kit with additional space to accommodate the type of system that is being repaired. The workspace should also be free of insulators that can cause an ESD event. On the work area, insulators such as Styrofoam and other plastics should always be moved at least 12 inches or 30 centimeters away from sensitive parts before physically handling any hardware components
- **ESD Packaging** – All ESD-sensitive devices must be shipped and received in static-safe packaging. Metal, static-shielded bags are preferred. However, you should always return the damaged part using the same ESD bag and packaging that the new part arrived in. The ESD bag should be folded over and taped shut and all the same foam packing material should be used in the original box that the new part arrived in. ESD-sensitive devices should be removed from packaging only at an ESD-protected work surface, and parts should never be placed on top of the ESD bag because only the inside of the bag is shielded. Always place parts in your hand, on the ESD mat, in the system, or inside an anti-static bag.
- **Transporting Sensitive Components** – When transporting ESD sensitive components such as replacement parts or parts to be returned to Dell, it is critical to place these parts in anti-static bags for safe transport.

ESD protection summary

It is recommended to use the traditional wired ESD grounding wrist strap and protective anti-static mat at all times when servicing Dell products. In addition, it is critical to keep sensitive parts separate from all insulator parts while performing service and that they use anti-static bags for transporting sensitive components.

Transporting sensitive components

When transporting ESD sensitive components such as replacement parts or parts to be returned to Dell, it is critical to place these parts in anti-static bags for safe transport.

After working inside your computer

About this task

 **NOTE:** Leaving stray or loose screws inside your computer may severely damage your computer.

Steps

1. Replace all screws and ensure that no stray screws remain inside your computer.
2. Connect any external devices, peripherals, or cables you removed before working on your computer.
3. Replace any media cards, discs, or any other parts that you removed before working on your computer.
4. Connect your computer and all attached devices to their electrical outlets.
5. Turn on your computer.

BitLocker

 **CAUTION:** If BitLocker is not suspended before updating the BIOS, the next time you reboot the system it will not recognize the BitLocker key. You will then be prompted to enter the recovery key to progress, and the system will ask for this on each reboot. If the recovery key is not known this can result in data loss or an unnecessary operating system reinstall. For more information about this subject, see Knowledge Article: [updating the BIOS on Dell systems with BitLocker enabled](#).

The installation of the following components triggers BitLocker:

- Hard disk drive or solid state drive
- System board

Recommended tools

The procedures in this document may require the following tools:

- Phillips screwdriver #0
- Plastic scribe

Screw list

 **NOTE:** When removing screws from a component, it is recommended to note the screw type, the quantity of screws, and then place them in a screw storage box. This is to ensure that the correct number of screws and correct screw type is restored when the component is replaced.

 **NOTE:** Some computers have magnetic surfaces. Ensure that the screws are not left attached to such surfaces when replacing a component.

NOTE: Screw color may vary with the configuration ordered.

Table 28. Screw list











Component	Screw type	Quantity	Screw image
Base cover	M2x5	6	
	Captive screw	2	
M.2 2230 solid-state drive	M2x2	1 (for Barcelo-R systems) 2 (for Mendocino systems)	
M.2 2280 solid-state drive	M2x2	1 (for Barcelo-R systems) 2 (for Mendocino systems)	
Wireless card	M2x3.5	1	
Fan	M2x5	2	
3-cell battery	M2x3	3	
4-cell battery	M2x3	4	
Touchpad Touchpad bracket	M2x2 M2x2	2 3	
Heat sink - UMA	Captive screws NOTE: Screws are part of the heat sink.	4	Captive
Heat sink - Discrete	<ul style="list-style-type: none"> M2x3 Captive screws NOTE: Screws are part of the heat sink.	<ul style="list-style-type: none"> 3 4 	<ul style="list-style-type: none">  Captive
Power button	M2x2	1	

Table 28. Screw list (continued)

Component	Screw type	Quantity	Screw image
Power button with optional fingerprint reader	M2x2	1	
I/O board	M2x3.5	2	
Display assembly	M2.5x5	4	
Display hinges	M2.5x3.8	6	
System board	<ul style="list-style-type: none"> • M2x3.5 • M2x2 (O.D. 5 mm) 	<ul style="list-style-type: none"> • 4 • 1 	
USB type-C bracket	M2x3.5	1	

Major components of Vostro 15 3535

The following image shows the major components of Vostro 15 3535.

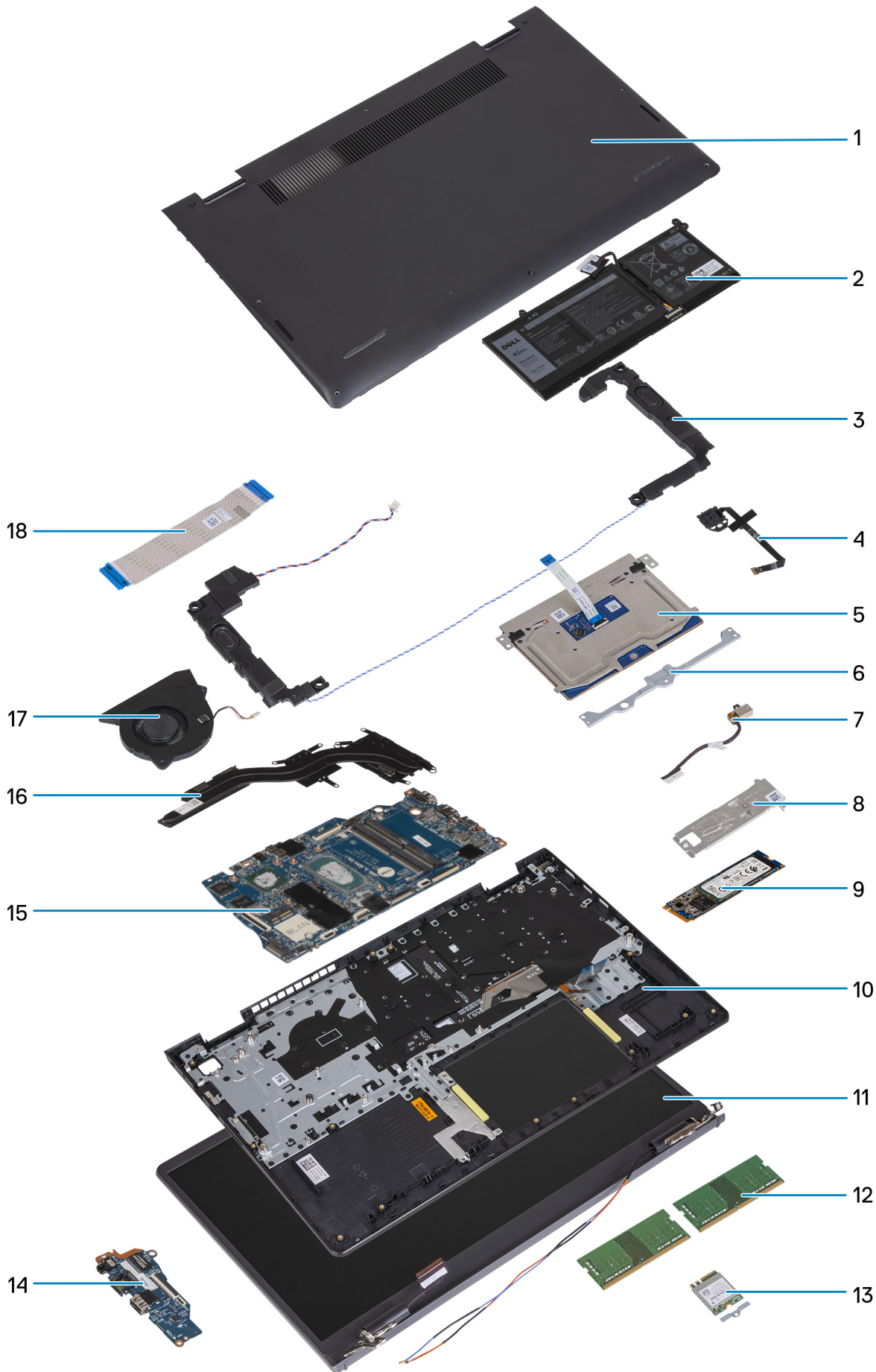

1. Base cover
2. Battery
3. Speakers
4. Power button with optional fingerprint reader
5. Touchpad
6. Touchpad bracket
7. Power adapter port
8. Solid-state drive thermal shield
9. M.2 2280 solid-state drive card
10. Palm-rest and keyboard assembly
11. Display assembly
12. Memory modules
13. Wireless card with bracket
14. I/O board
15. System board
16. Heat sink
17. Fan
18. I/O board FFC

 **NOTE:** Dell provides a list of components and their part numbers for the original system configuration purchased. These parts are available according to warranty coverages purchased by the customer. Contact your Dell sales representative for purchase options.

Removing and installing Customer Replaceable Units (CRUs)

The replaceable components in this chapter are Customer Replaceable Units (CRUs).

CAUTION: Customers can replace only the Customer Replaceable Units (CRUs) following the safety precautions and replacement procedures.

NOTE: The images in this document may differ from your computer depending on the configuration you ordered.

Secure Digital (SD) Card

Removing the Secure Digital card

Prerequisites

1. Follow the procedure in [Before working inside your computer](#).

About this task

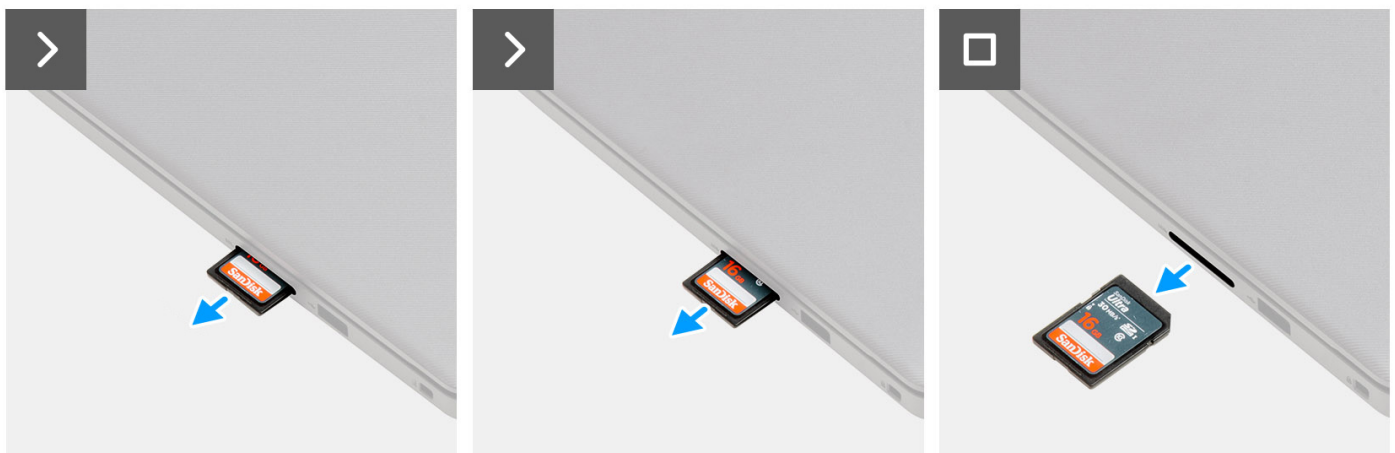

Steps

Pull the SD memory card out of its slot to remove it.

Installing the Secure Digital card

Prerequisites

If you are replacing a component, remove the existing component before performing the installation procedure.

About this task

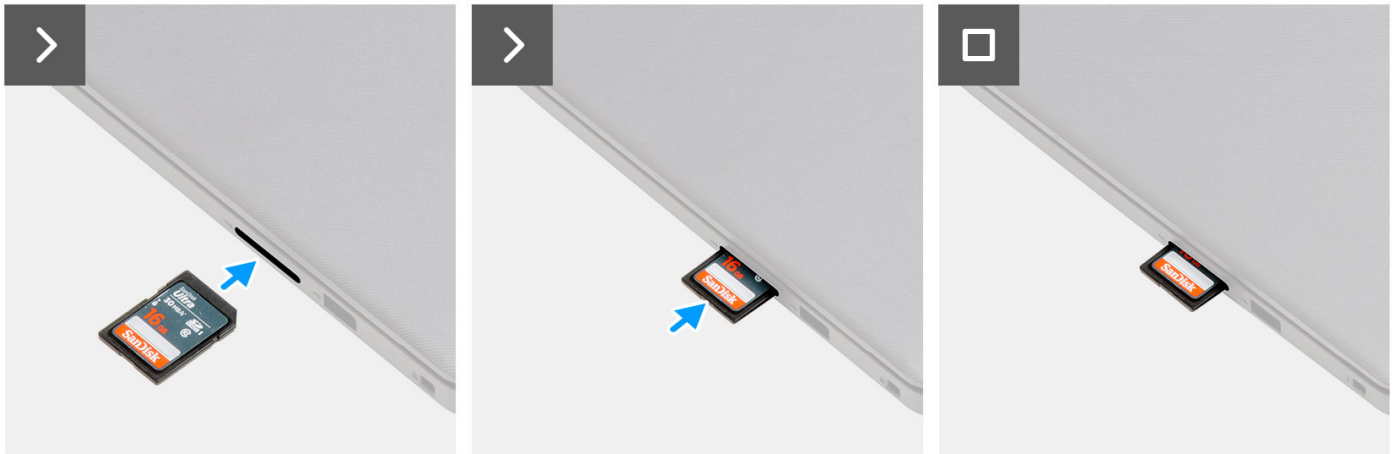

Steps

Push the SD memory card out into its slot to insert it.

Next steps

1. Follow the procedure in [After working inside your computer](#).

Base cover

Removing the base cover

Prerequisites

1. Follow the procedure in [Before working inside your computer](#).
2. Remove the [SD card](#).

About this task

NOTE: Before removing the base cover, ensure that there is no SD card installed in the SD card slot on your computer.

The following images indicate the location of the base cover and provide a visual representation of the removal procedure.



6x
M2x5



2x



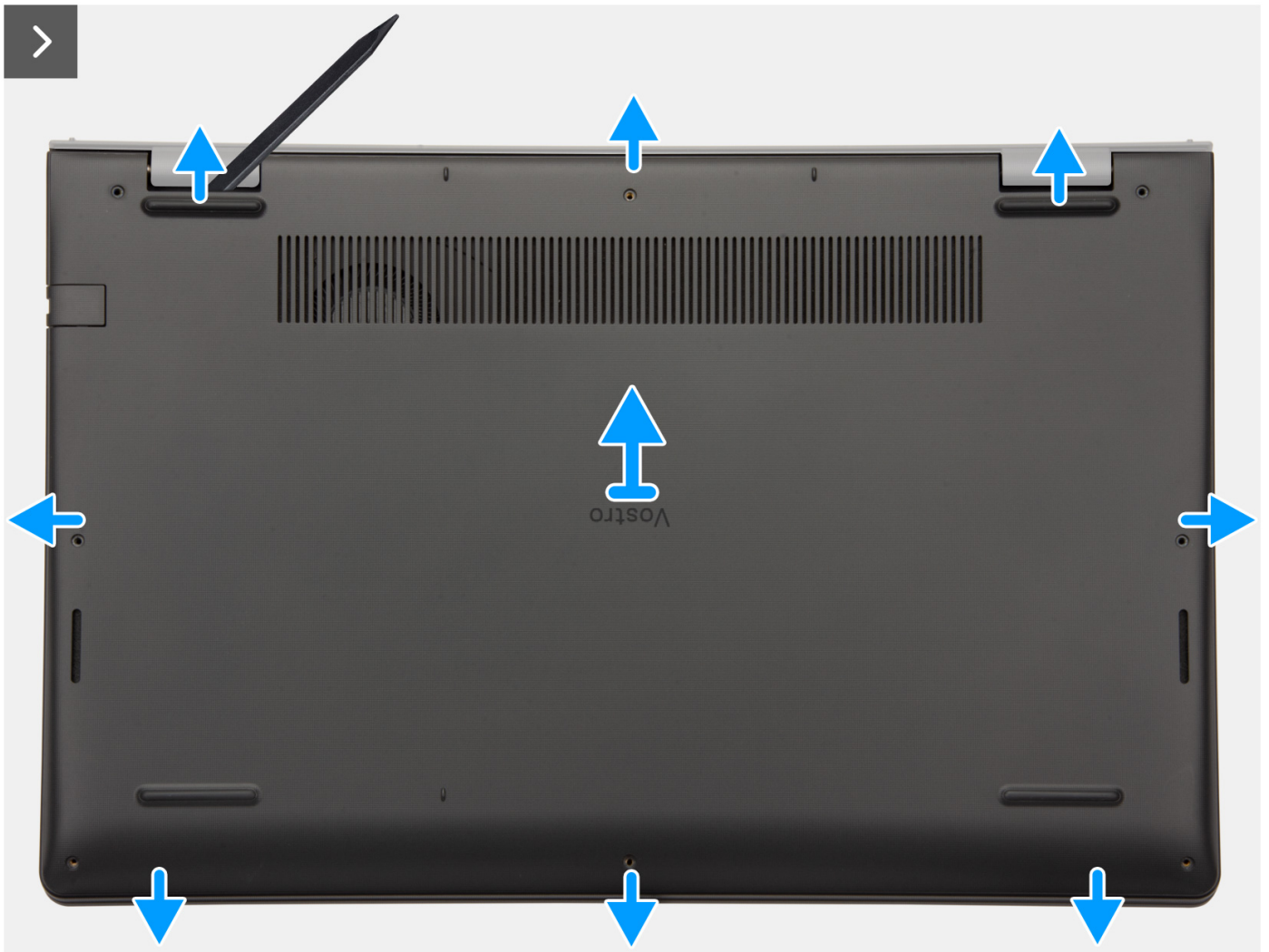

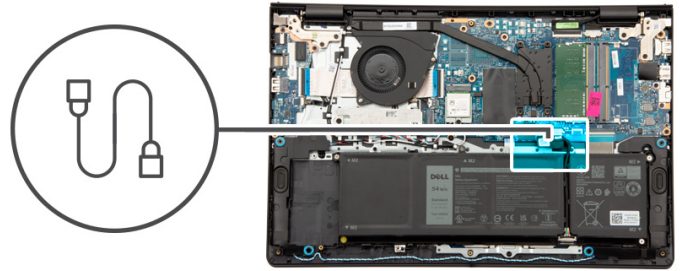

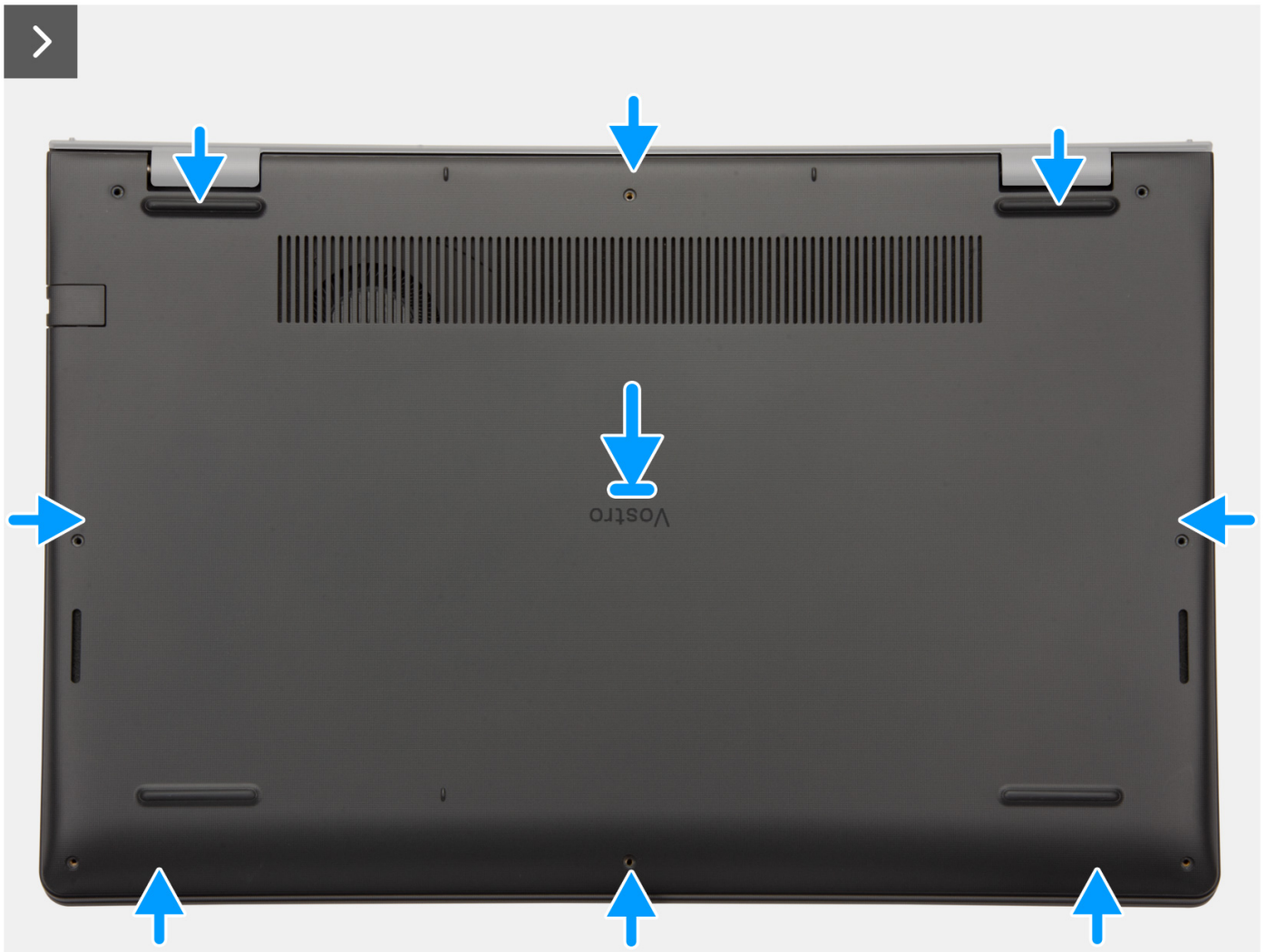



Steps

1. Connect the battery cable to the connector on the system board.
2. Place and snap the base cover into place on the palm-rest and keyboard assembly.
3. Tighten the two captive screws that secure the base cover to the palm-rest and keyboard assembly.
4. Replace the six screws (M2x5) that secure the base cover to the palm-rest and keyboard assembly.

Next steps

1. Install the [SD card](#).
2. Follow the procedure in [After working inside your computer](#).

Memory modules

Removing the memory modules

Prerequisites

1. Follow the procedure in [Before working inside your computer](#).
2. Remove the [SD card](#).
3. Remove the [base cover](#).

About this task

The following images indicate the location of the memory modules and provide a visual representation of the removal procedure.

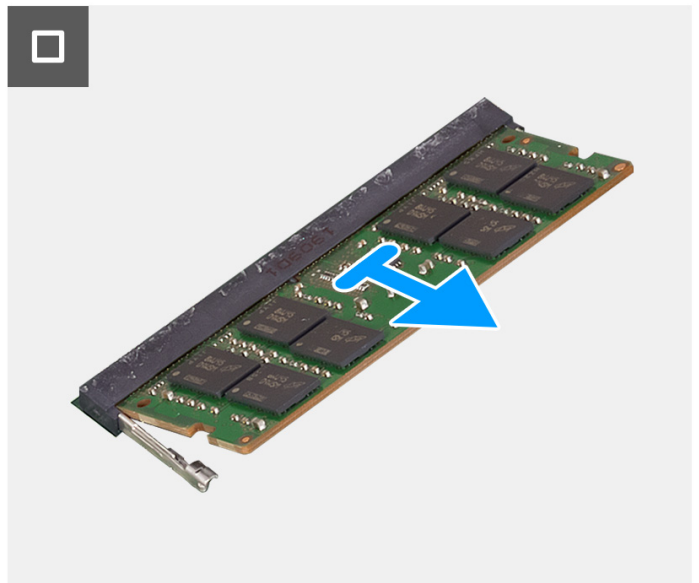
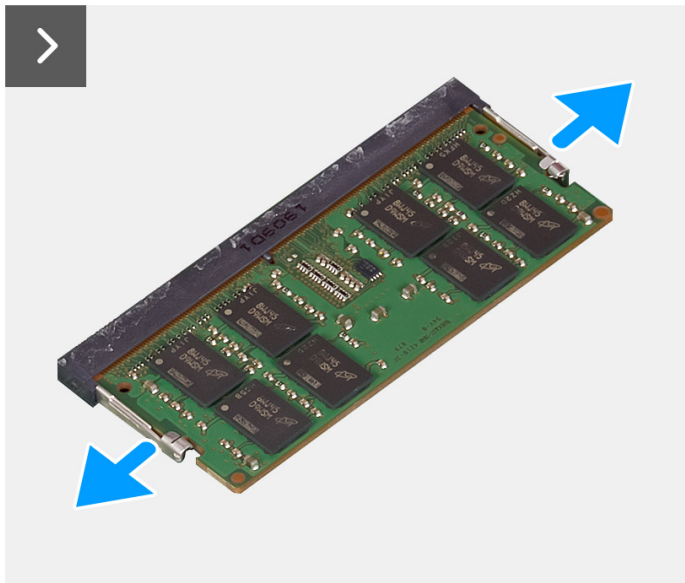
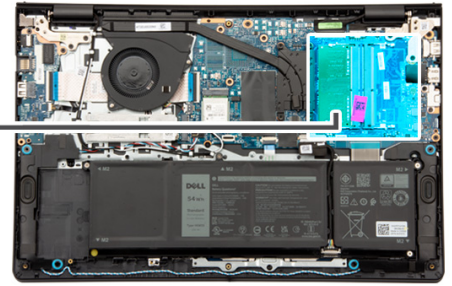
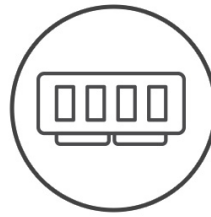

Steps

1. Using your fingertips, carefully spread apart the securing-clips on each end of the memory-module slot until the memory module pops-up.
2. Remove the memory module from the memory-module slot on the system board.
i **NOTE:** Your computer may have up to two memory modules installed. Repeat steps 1 to 2 if there is a second memory module installed.

Installing the memory modules

Prerequisites

If you are replacing a component, remove the existing component before performing the installation process.

About this task

The following images indicate the location of the memory modules and provide a visual representation of the installation procedure.

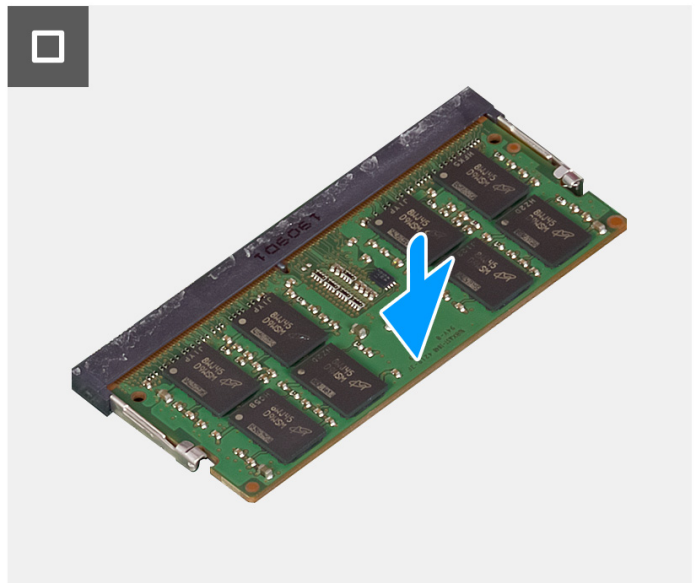
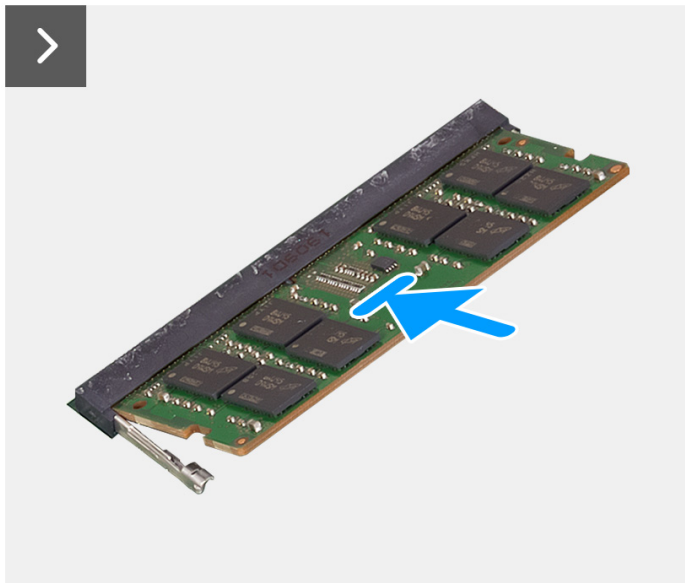
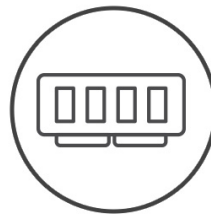

Steps

1. Align the notch on the memory module with the tab on the memory-module slot on the system board.
2. Slide the memory module into the memory-module slot on the system board.
3. Press down on the memory module until the securing clips click, locking the memory module in place.

 **NOTE:** Repeat steps 1 to 3 if there is a second memory module to be installed into your computer.

Next steps

1. Install the [base cover](#).
2. Install the [SD card](#).
3. Follow the procedure in [After working inside your computer](#).

M.2 solid-state drive

Removing the M.2 2230 solid state drive

Prerequisites

1. Follow the procedure in [Before working inside your computer](#).
2. Remove the [SD card](#).
3. Remove the [base cover](#).

About this task

i **NOTE:** This procedure applies only to computers shipped with an M.2 2230 solid state drive installed.

i **NOTE:** The M.2 card installed on your computer depends on the configuration ordered. Supported card configurations on the M.2 card slot:

- M.2 2230 solid state drive
- M.2 2280 solid state drive

The following images indicate the location of the M.2 2230 solid state drive and provide a visual representation of the removal procedure.



1x
M2x2

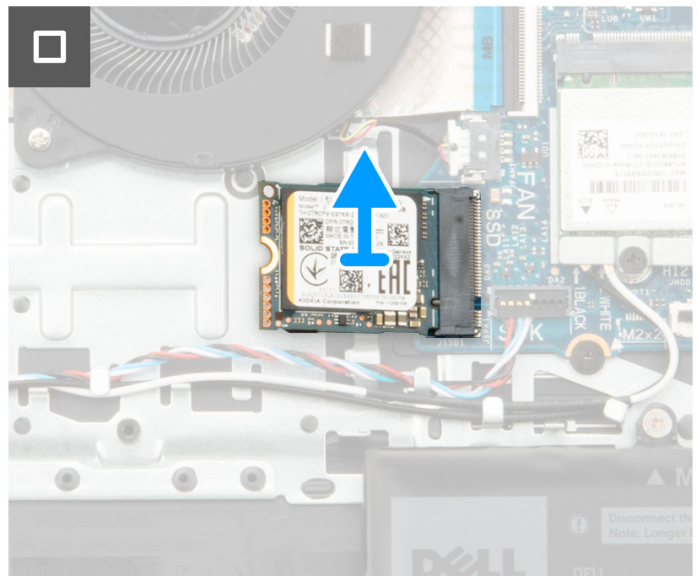
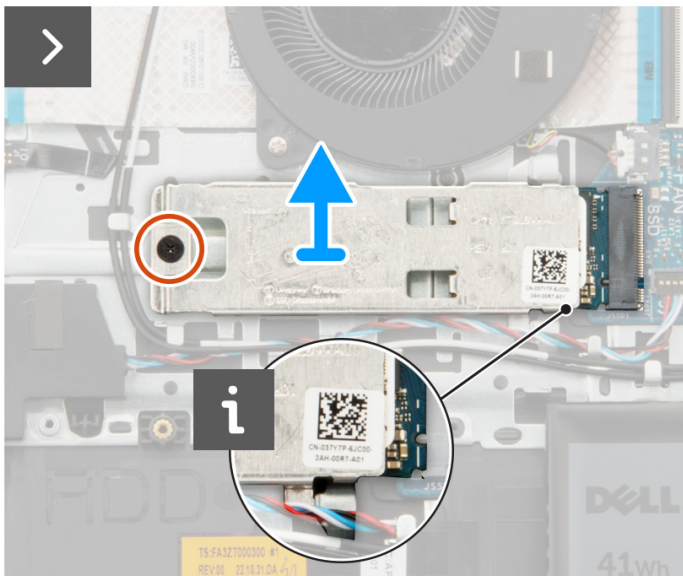

Steps

1. Remove the (M2x2) screw that secures the M.2 thermal plate to the palm-rest and keyboard assembly.

i **NOTE:** There is one (M2x2) screw for Barcelo-R systems and two (M2x2) screws for Mendocino systems.

2. Slide and lift the solid state drive thermal plate off the solid state drive.

3. Slide and remove the M.2 2230 solid state drive from the M.2 card slot on the system board.

Installing the M.2 2230 solid state drive

Prerequisites

If you are replacing a component, remove the existing component before performing the installation process.

About this task

i **NOTE:** This procedure applies if you are installing a M.2 2230 solid state drive.

i **NOTE:** The M.2 card installed on your computer depends on the configuration ordered. Supported card configurations on the M.2 card slot:

- M.2 2230 solid state drive
- M.2 2280 solid state drive

The following images indicate the location of the M.2 2230 solid state drive and provide a visual representation of the installation procedure.



1x
M2x2

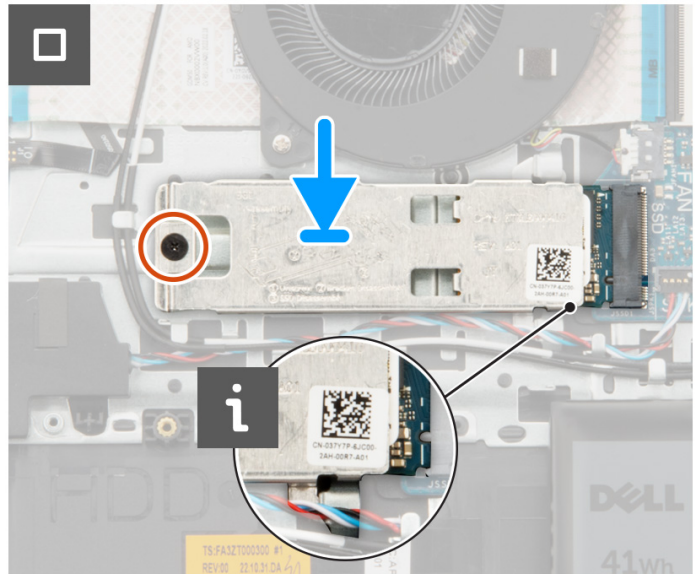
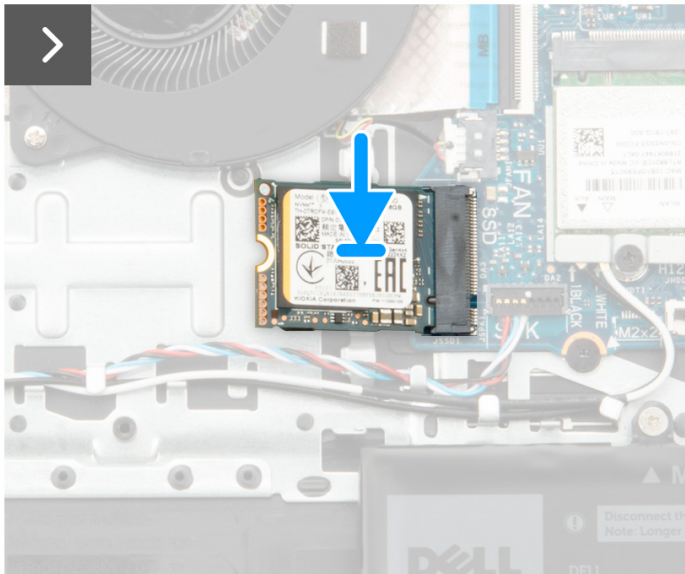

Steps

1. Align the notch on the M.2 2230 solid state drive with the tab on the M.2 card slot on the system board.
2. Slide the M.2 2230 solid state drive into the M.2 card slot on the system board .
3. Place the M.2 thermal plate on the M.2 2230 solid state drive.
4. Align the screw holes on the M.2 thermal plate with the screw holes on the palm-rest and keyboard assembly.
5. Replace the (M2x2) screw that secures the M.2 thermal plate to the palm-rest and keyboard assembly.

Next steps

1. Install the [base cover](#).
2. Install the [SD card](#).
3. Follow the procedure in [After working inside your computer](#).

Removing the M.2 2280 solid state drive

Prerequisites

1. Follow the procedure in [Before working inside your computer](#).
2. Remove the [SD card](#).
3. Remove the [base cover](#).

About this task

NOTE: This procedure applies only to computers shipped with a M.2 2280 solid state drive installed.

NOTE: The M.2 card installed on your computer depends on the configuration ordered. Supported card configurations on the M.2 card slot:

- M.2 2230 solid state drive
- M.2 2280 solid state drive

The following images indicate the location of the M.2 2280 solid state drive and provide a visual representation of the removal procedure.



1x
M2x2

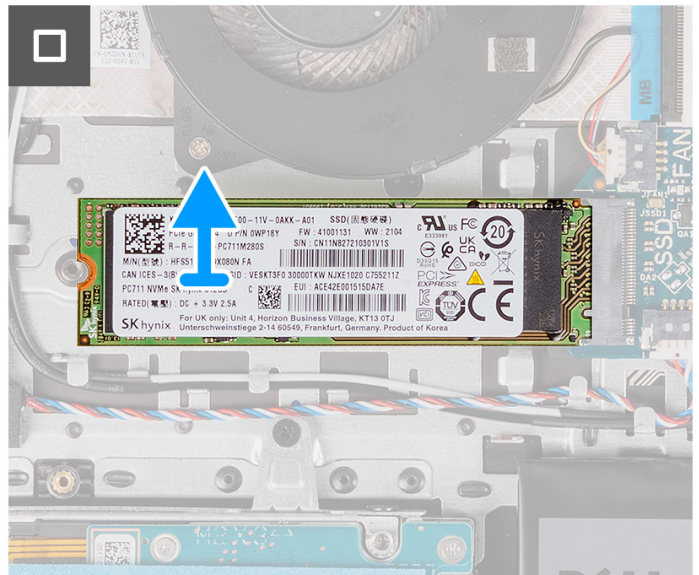
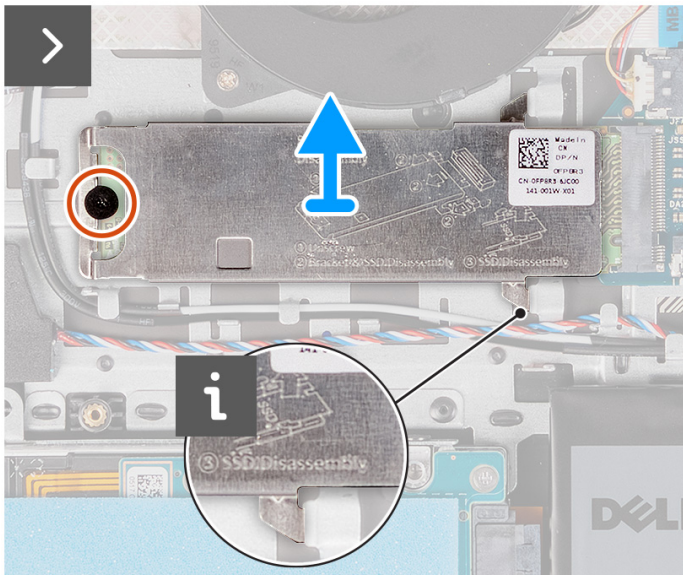
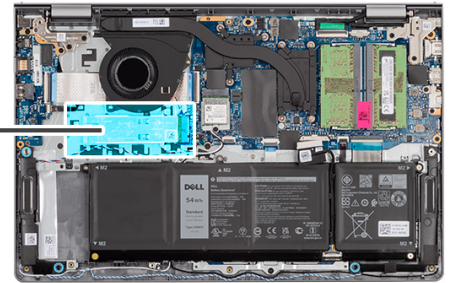

Steps

1. Remove the (M2x2) screw that secures the M.2 thermal plate to the palm-rest and keyboard assembly.
NOTE: There is one (M2x2) screw for Barcelo-R systems and two (M2x2) screws for Mendocino systems.
2. Slide and lift the solid state drive thermal plate off the solid state drive.
3. Slide and remove the M.2 2280 solid state drive from the M.2 card slot on the system board.

Installing the M.2 2280 solid state drive

Prerequisites

If you are replacing a component, remove the existing component before performing the installation process.

About this task

NOTE: This procedure applies if you are installing a M.2 2280 solid state drive.

NOTE: The M.2 card installed on your computer depends on the configuration ordered. Supported card configurations on the M.2 card slot:

- M.2 2230 solid state drive
- M.2 2280 solid state drive

The following images indicate the location of the M.2 2280 solid state drive and provide a visual representation of the installation procedure.



1x
M2x2

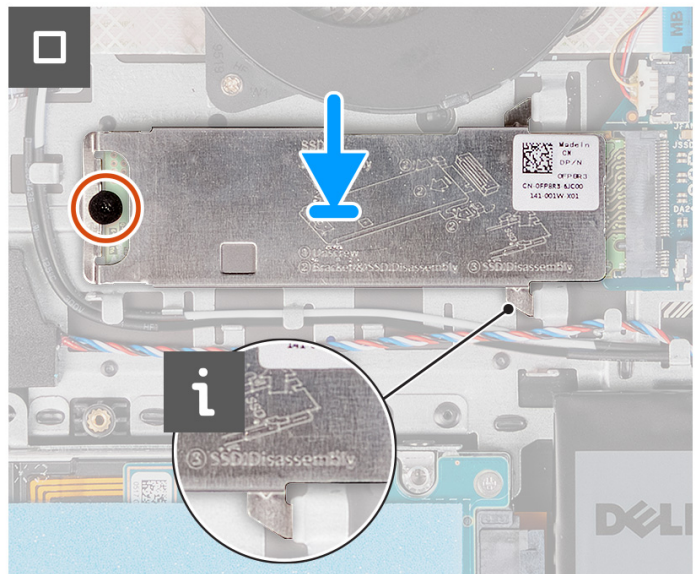
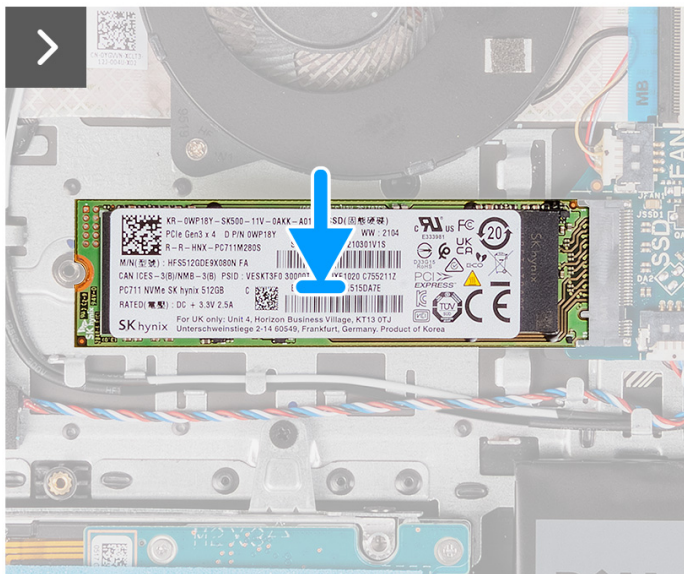
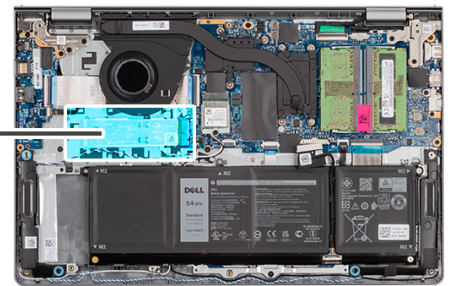

Steps

1. Align the notch on the M.2 2280 solid state drive with the tab on the M.2 card slot on the system board.
2. Slide the M.2 2280 solid state drive into the M.2 card slot on the system board.
3. Place the M.2 thermal plate on the M.2 2280 solid state drive.
4. Align the screw holes on the M.2 thermal plate with the screw holes on the palm-rest and keyboard assembly.
5. Replace the (M2x2) screw that secures the M.2 thermal plate and the M.2 solid state drive to the palm-rest and keyboard assembly.

Next steps

1. Install the [base cover](#).
2. Install the [SD card](#).
3. Follow the procedure in [After working inside your computer](#).

Wireless card

Removing the wireless card

Prerequisites

1. Follow the procedure in [Before working inside your computer](#).
2. Remove the [SD card](#).
3. Remove the [base cover](#).

About this task

The following images indicate the location of the wireless card and provide a visual representation of the removal procedure.



1x
M2x3.5

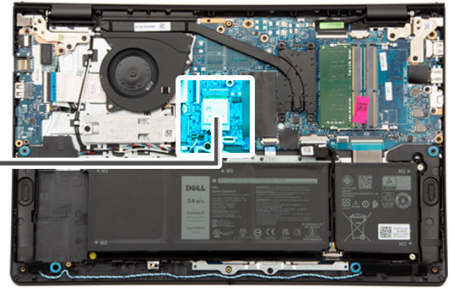

Steps

1. Remove the screw (M2x3.5) that secures the wireless-card bracket to the system board.
2. Lift the wireless-card bracket from the wireless card.
3. Disconnect the antenna cables from the wireless card.
4. Slide and remove the wireless card from the WLAN slot on the system board.

Installing the wireless card

Prerequisites

If you are replacing a component, remove the existing component before performing the installation process.

About this task

The following images indicate the location of the wireless card and provide a visual representation of the installation procedure.



1x
M2x3.5



Steps

1. Connect the antenna cables to the wireless card.

The following table provides the antenna-cable color scheme for the wireless card supported by your computer.

Table 29. Antenna-cable color scheme

Connectors on the wireless card	Antenna-cable color	Silkscreen marking	
Main	White	MAIN	△ (white triangle)
Auxiliary	Black	AUX	▲ (black triangle)

2. Slide the wireless card into the WLAN slot on the system board.
3. Place the wireless-card bracket on the wireless card.
4. Replace the screw (M2x3.5) that secures the wireless-card bracket to the system board.

Next steps

1. Install the [base cover](#).
2. Install the [SD card](#).
3. Follow the procedure in [After working inside your computer](#).

Fan

Removing the fan

Prerequisites

1. Follow the procedure in [Before working inside your computer](#).
2. Remove the [SD card](#).
3. Remove the [base cover](#).

About this task

The following images indicate the location of the fan and provide a visual representation of the removal procedure.



2x
M2x5

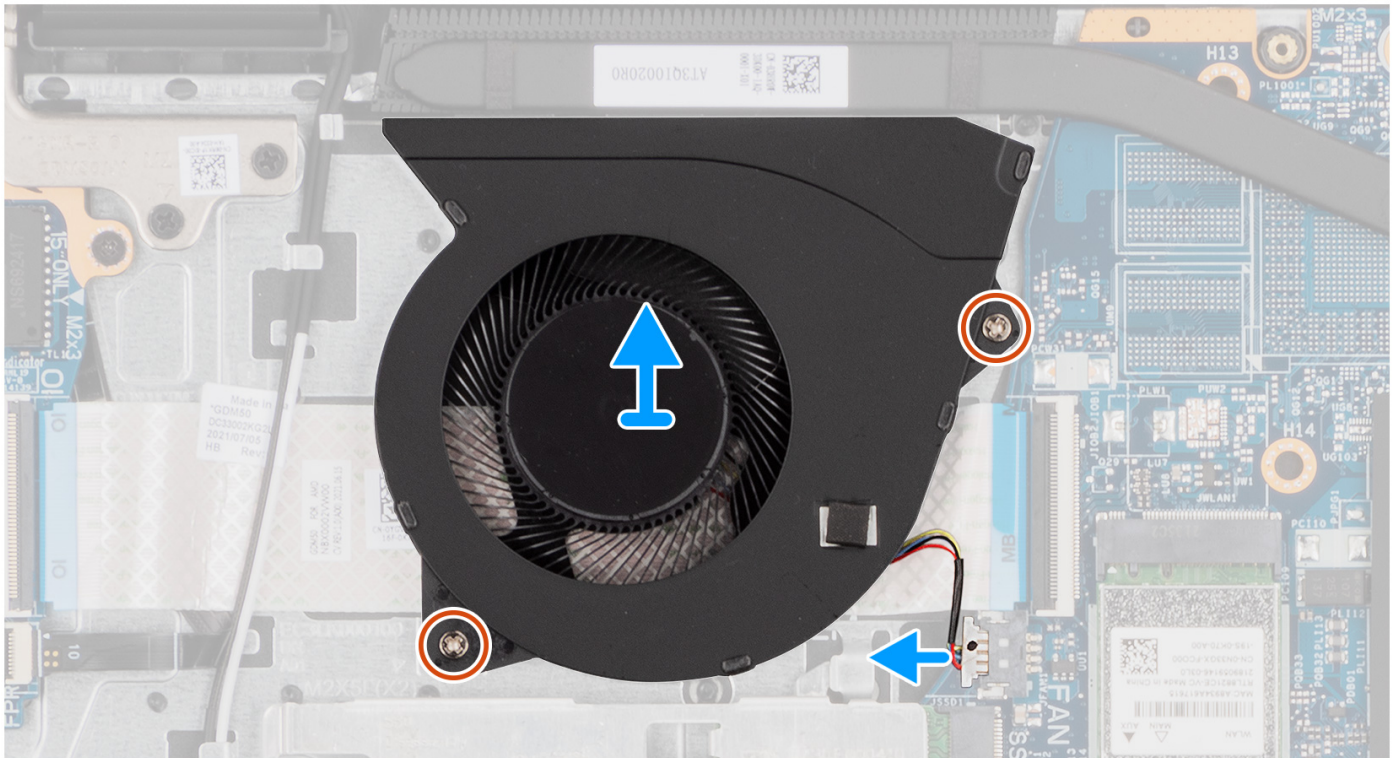
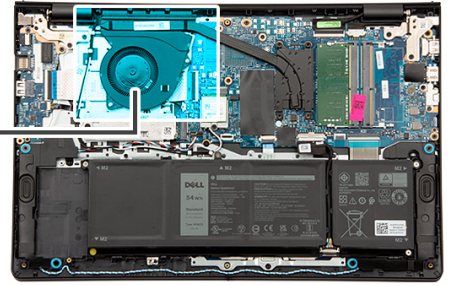
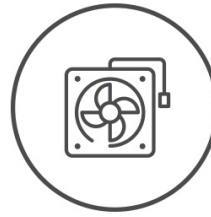

Steps

1. Disconnect the fan cable from the system board.
2. Remove the two (M2x5) screws that secure the fan to the palm-rest and keyboard assembly.
3. Lift the fan from the palm-rest and keyboard assembly.

Installing the fan

Prerequisites

If you are replacing a component, remove the existing component before performing the installation process.

About this task

The following images indicate the location of the fan and provide a visual representation of the installation procedure.



2x
M2x5

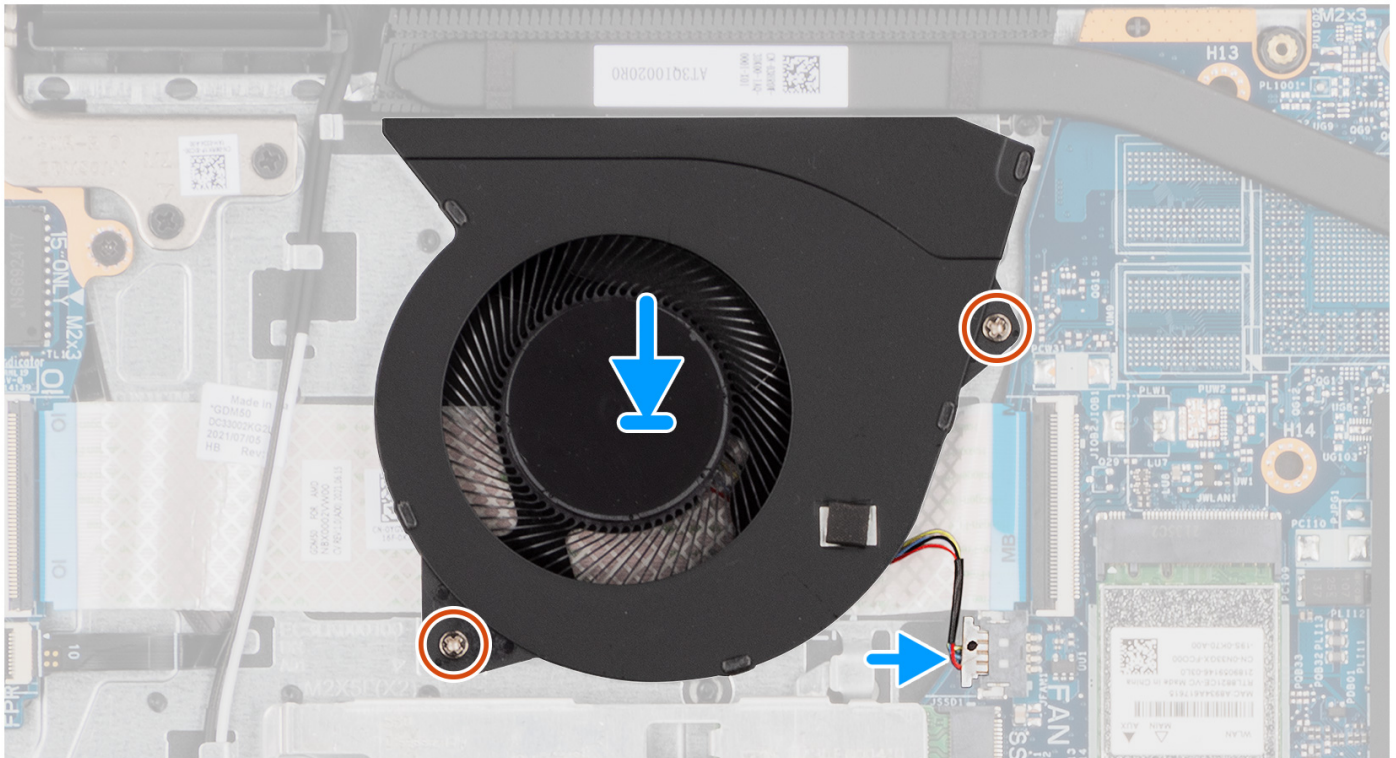
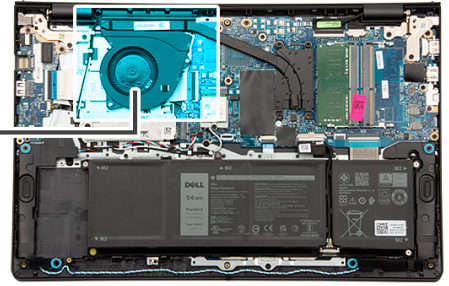
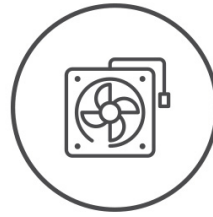

Steps

1. Place the fan on the palm-rest and keyboard assembly.
2. Align the screw holes on the fan to the screw holes on the palm-rest and keyboard assembly.
3. Replace the two (M2x5) screws that secure the fan to the palm-rest and keyboard assembly.
4. Connect the fan cable to the connector on the system board.

Next steps

1. Install the [base cover](#).
2. Install the [SD card](#).
3. Follow the procedure in [After working inside your computer](#).

Speakers

Removing the speakers

Prerequisites

1. Follow the procedure in [Before working inside your computer](#).
2. Remove the [SD card](#).

3. Remove the [base cover](#).

About this task

The following images indicate the location of the speakers and provide a visual representation of the removal procedure.

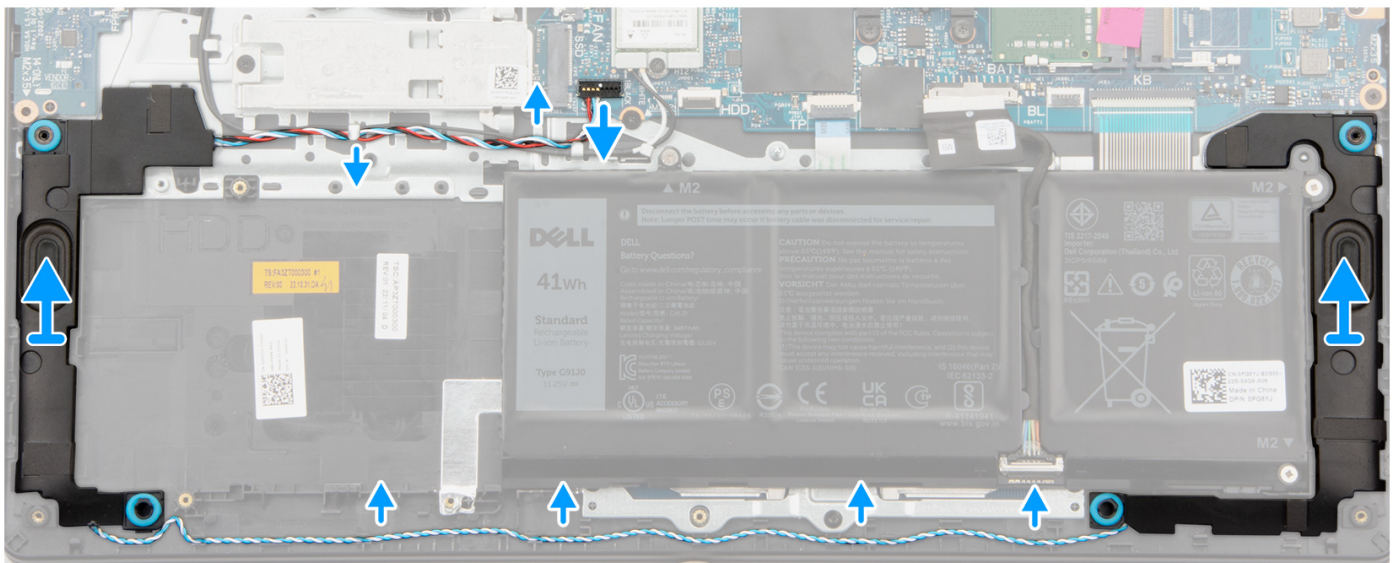
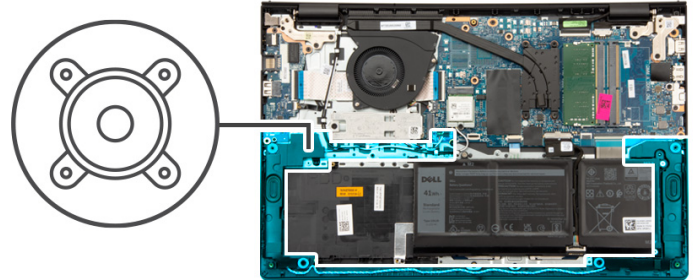

Steps

1. Disconnect the speaker cable from the system board.
2. Unroute the speaker cable from the routing guides on the palm-rest and keyboard assembly.

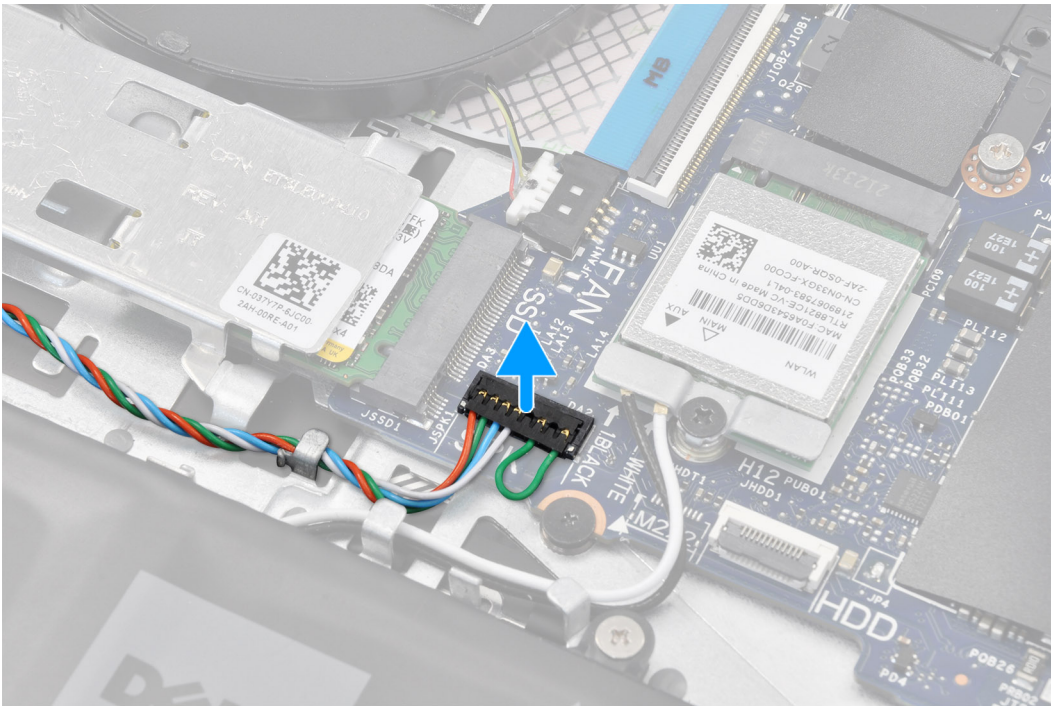

NOTE: For models shipped with a speaker cable featuring an eight-pin connector, to disconnect the speaker cable from the system board, pry up the bottom side of the cable connector's head first and then pull it away from the connector.

3. Lift the speakers along with its cable from the palm-rest and keyboard assembly.

Installing the speakers

Prerequisites

If you are replacing a component, remove the existing component before performing the installation process.

About this task

The following images indicate the location of the speakers and provide a visual representation of the installation procedure.

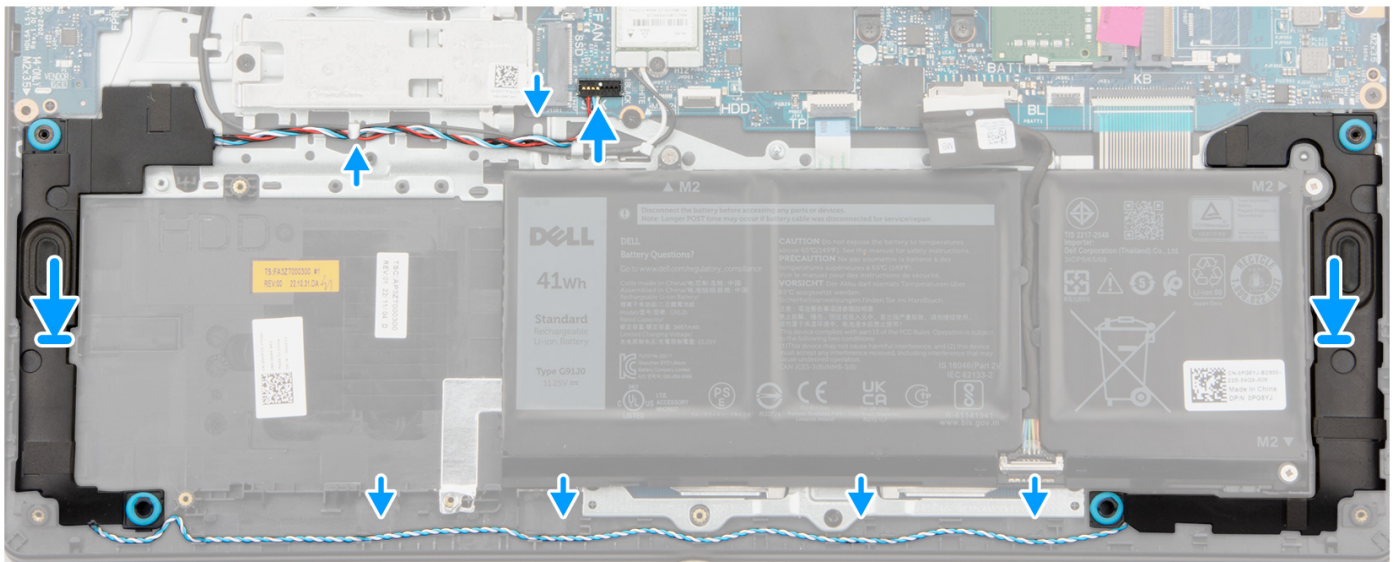
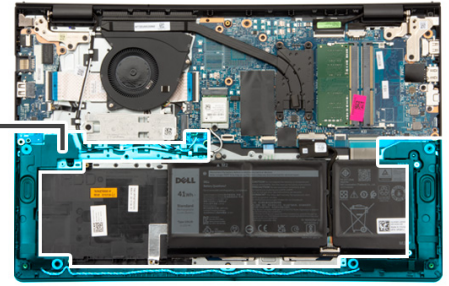
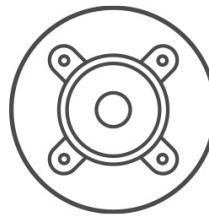

Steps

1. Using the alignment posts, place the speakers on the palm-rest and keyboard assembly.

i **NOTE:** Ensure that the alignment posts are threaded through the rubber grommets on the speaker.

2. Route the speaker cable through the routing guides on the palm-rest and keyboard assembly.

i **NOTE:** Route the speaker cable along the bottom side of the palm rest, over the WLAN antenna cables (for models shipped with WLAN antennas in the display assembly), and then secure the cable through the routing guides on the palm-rest.

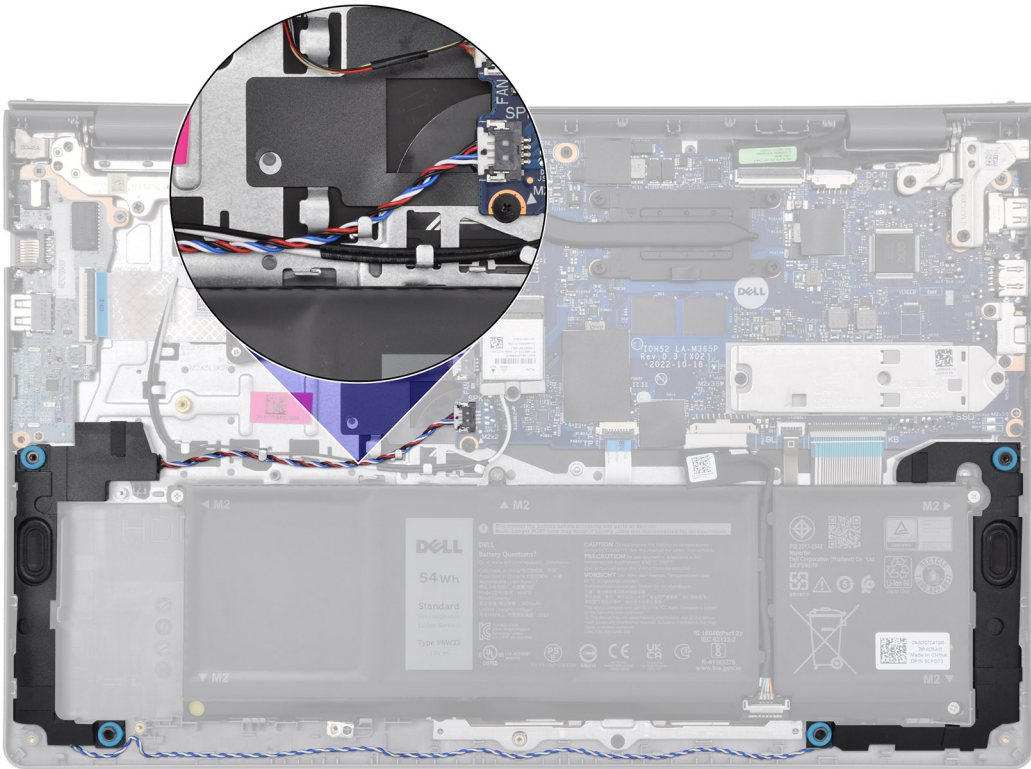

3. Connect the speaker cable to the system board.

Next steps

1. Install the [base cover](#).
2. Install the [SD card](#).
3. Follow the procedure in [After working inside your computer](#).

Removing and installing Field Replaceable Units (FRUs)

The replaceable components in this chapter are Field Replaceable Units (FRUs).

CAUTION: The information in this section is intended for authorized service technicians only.

CAUTION: To avoid any potential damage to the component or loss of data, ensure that an authorized service technician replaces the Field Replaceable Units (FRUs).

CAUTION: Dell Technologies recommends that this set of repairs, if needed, to be conducted by trained technical repair specialists.

CAUTION: As a reminder, your warranty does not cover damages that may occur during the courses of FRU repairs that are not authorized by Dell Technologies.

NOTE: The images in this document may differ from your computer depending on the configuration you ordered.

Battery

Lithium-ion battery precautions

CAUTION:

- Exercise caution when handling Lithium-ion batteries.
- Discharge the battery completely before removing it. Disconnect the AC power adapter from the system and operate the computer solely on battery power—the battery is fully discharged when the computer no longer turns on when the power button is pressed.
- Do not crush, drop, mutilate, or penetrate the battery with foreign objects.
- Do not expose the battery to high temperatures, or disassemble battery packs and cells.
- Do not apply pressure to the surface of the battery.
- Do not bend the battery.
- Do not use tools of any kind to pry on or against the battery.
- Ensure any screws during the servicing of this product are not lost or misplaced, to prevent accidental puncture or damage to the battery and other system components.
- If the battery gets stuck inside your computer as a result of swelling, do not try to release it as puncturing, bending, or crushing a lithium-ion battery can be dangerous. In such an instance, contact Dell technical support for assistance. See www.dell.com/contactdell.
- Always purchase genuine batteries from www.dell.com or authorized Dell partners and resellers.
- Swollen batteries should not be used and should be replaced and disposed properly. For guidelines on how to handle and replace swollen Lithium-ion batteries, see [Handling swollen Lithium-ion batteries](#).

Removing the 3-cell battery

CAUTION: The information in this section is intended for authorized service technicians only.

Prerequisites

1. Follow the procedure in [Before working inside your computer](#).
2. Remove the [SD card](#).
3. Remove the [base cover](#).

About this task

The following image indicates the location of the 3-cell battery and provides a visual representation of the removal procedure.

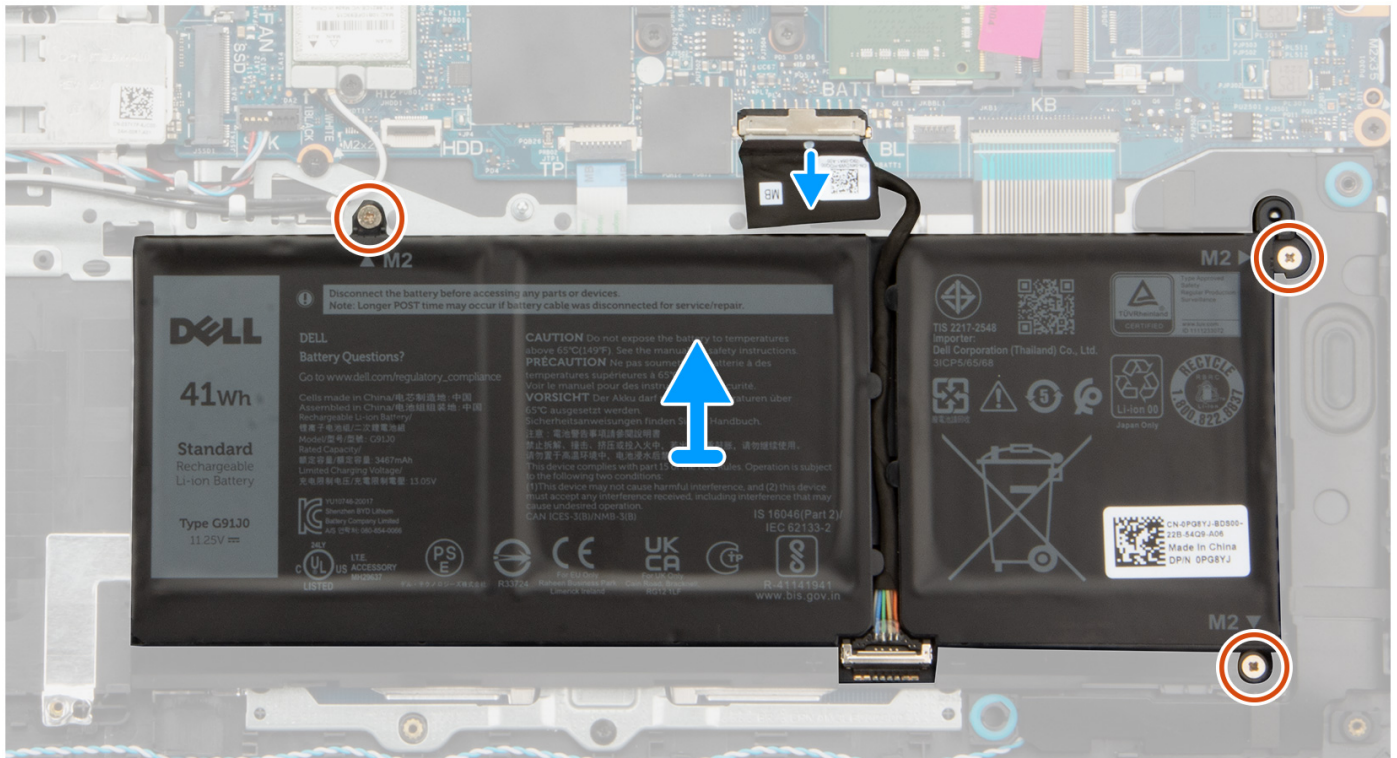
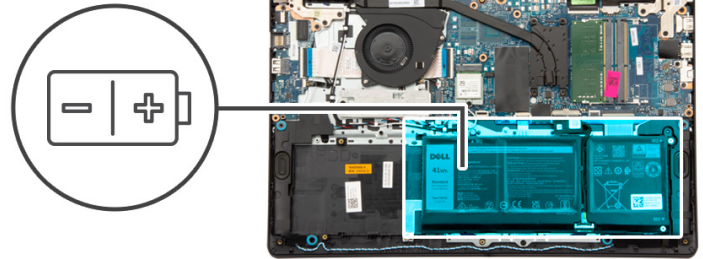

Steps

1. Disconnect the battery cable from the system board, if applicable.
2. Remove the three (M2x3) screws that secure the battery to the palm-rest and keyboard assembly.
3. Remove the battery from the palm-rest and keyboard assembly.

Installing the 3-cell battery

CAUTION: The information in this section is intended for authorized service technicians only.

Prerequisites

If you are replacing a component, remove the existing component before performing the installation process.

About this task

The following image indicates the location of the 3-cell battery and provides a visual representation of the installation procedure.



3x
M2x3

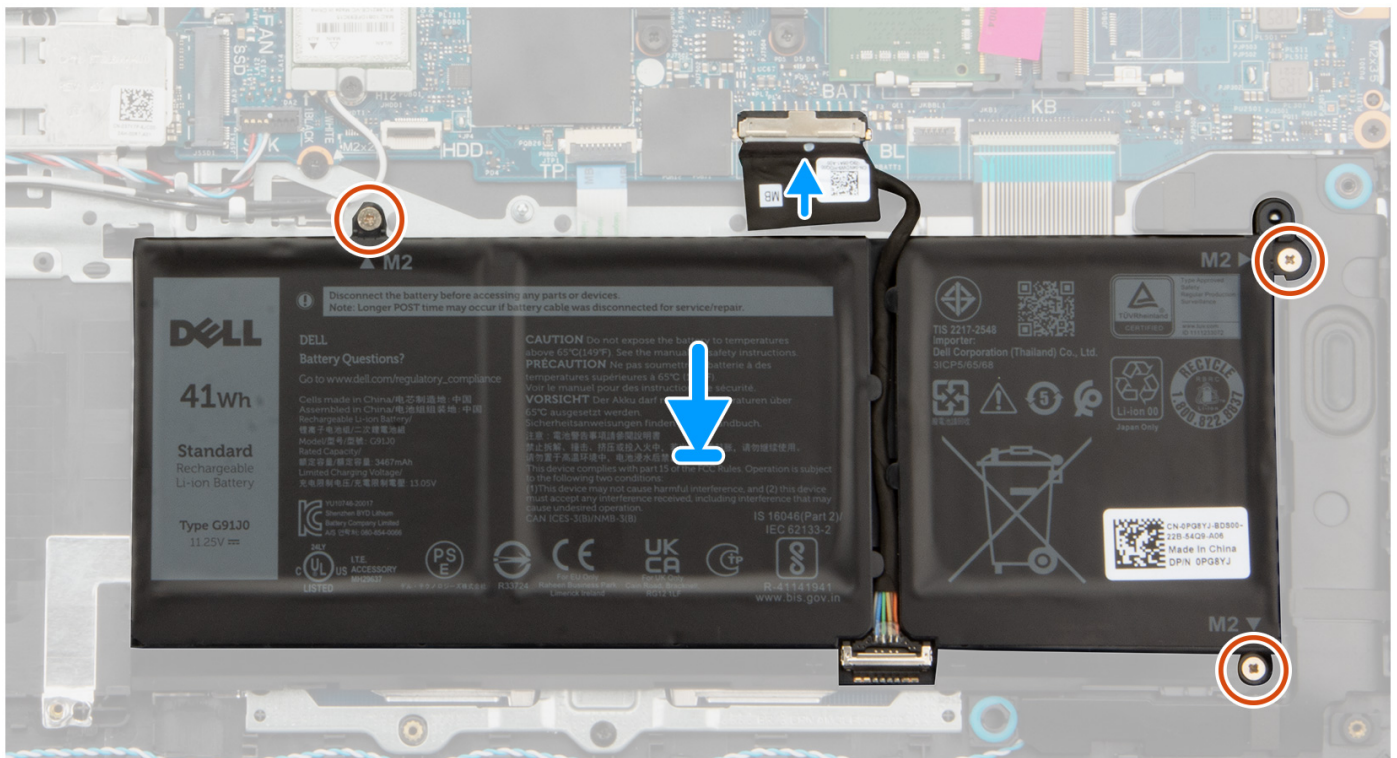
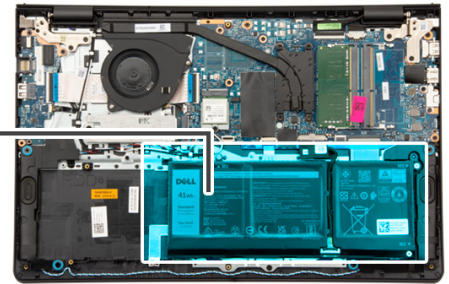
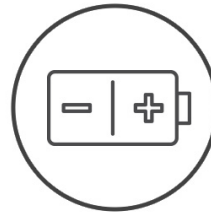

Steps

1. Place the battery on the palm-rest and keyboard assembly.
2. Align the screw holes on the battery to the screw holes on the palm-rest and keyboard assembly.
3. Replace the three (M2x3) screws that secure the battery to the palm-rest and keyboard assembly.
4. Connect the battery cable to the connector on the system board.

Next steps

1. Install the [base cover](#).
2. Install the [SD card](#).
3. Follow the procedure in [After working inside your computer](#).

Removing the 4-cell battery

 **CAUTION:** The information in this section is intended for authorized service technicians only.

Prerequisites

1. Follow the procedure in [Before working inside your computer](#).
2. Remove the [SD card](#).
3. Remove the [base cover](#).

About this task

The following image indicates the location of the 4-cell battery and provides a visual representation of the removal procedure.

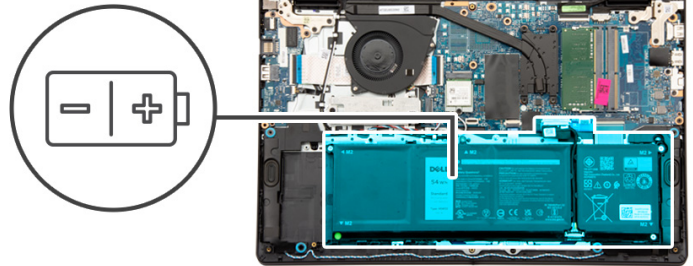

Steps

1. Disconnect the battery cable from the system board, if applicable.
2. Remove the four (M2x3) screws that secure the battery to the palm-rest and keyboard assembly.
3. Remove the battery from the palm-rest and keyboard assembly.

NOTE: When replacing the 4-cell battery, use a scribe push upward through the bottom-left screw hole to remove the battery rubber stopper and transfer it to the new replacement 4-cell battery.

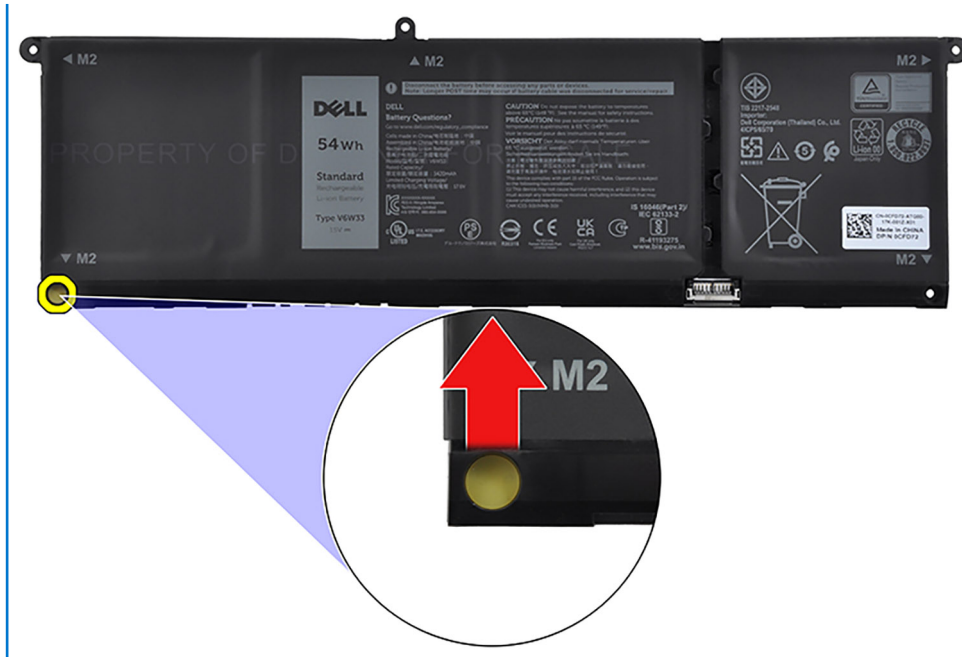

Installing the 4-cell battery

CAUTION: The information in this section is intended for authorized service technicians only.

Prerequisites

If you are replacing a component, remove the existing component before performing the installation process.

About this task

The following image indicates the location of the 4-cell battery and provides a visual representation of the installation procedure.



4x
M2x3

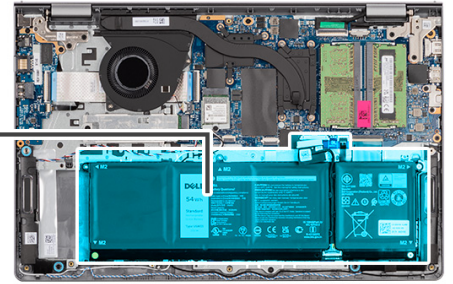
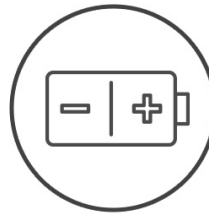

Steps

1. Place the battery on the palm-rest and keyboard assembly.
2. Align the screw holes on the battery to the screw holes on the palm-rest and keyboard assembly.
3. Replace the four (M2x3) screws that secure the battery to the palm-rest and keyboard assembly.
4. Connect the battery cable to the connector on the system board.

NOTE: When replacing the 4-cell battery, use a scribe push upward through the bottom-left screw hole to remove the battery rubber stopper and transfer it to the new replacement 4-cell battery.

Next steps

1. Install the [base cover](#).
2. Install the [SD card](#).
3. Follow the procedure in [After working inside your computer](#).

Disconnecting the battery cable

CAUTION: The information in this section is intended for authorized service technicians only.

Prerequisites

1. Follow the procedure in [Before working inside your computer](#).
2. Remove the [SD card](#).
3. Remove the [base cover](#).

About this task

The following images indicate the location of the battery cable and provide a visual representation of the removal procedure.



Steps

1. Lift the latch on the battery cable.
2. Disconnect the battery cable from the connector on the battery.

Connecting the battery cable

CAUTION: The information in this section is intended for authorized service technicians only.

Prerequisites

If you are replacing a component, remove the existing component before performing the installation process.

About this task

The following images indicate the location of the battery cable and provide a visual representation of the installation procedure.



Steps

1. Connect the battery cable to the connector on the battery.
2. Close the latch on the battery cable connector to secure it to the battery.

Next steps

1. Install the [base cover](#).
2. Install the [SD card](#).
3. Follow the procedure in [After working inside your computer](#).

Touchpad

Removing the touchpad

⚠ CAUTION: The information in this section is intended for authorized service technicians only.

Prerequisites

1. Follow the procedure in [Before working inside your computer](#).
2. Remove the [SD card](#).
3. Remove the [base cover](#).
4. Remove the [3-cell battery](#) or [4-cell battery](#) (whichever applicable).

About this task

The following images indicate the location of the touchpad and provide a visual representation of the removal procedure.



5x
M2x2

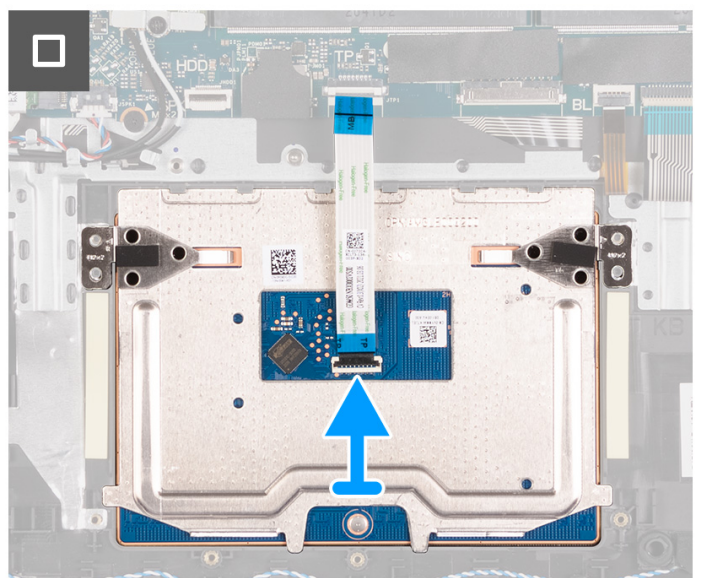
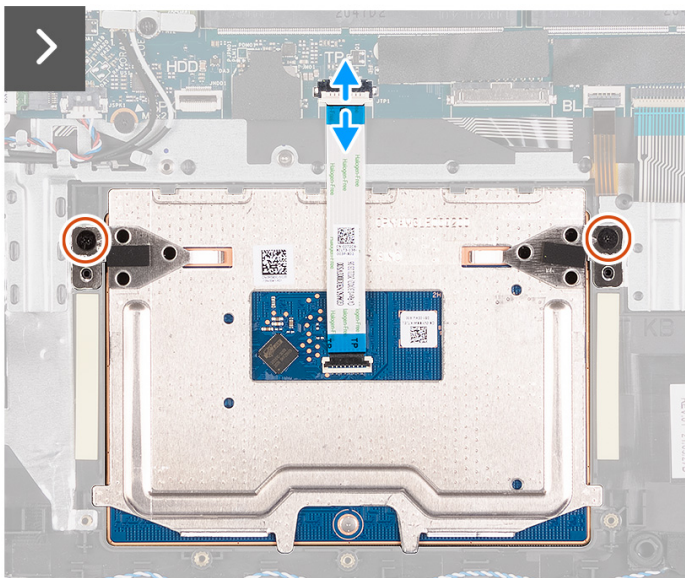
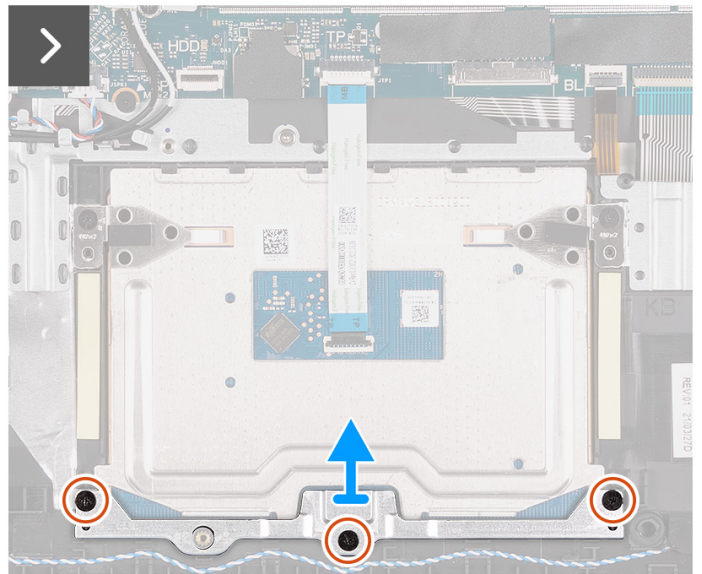
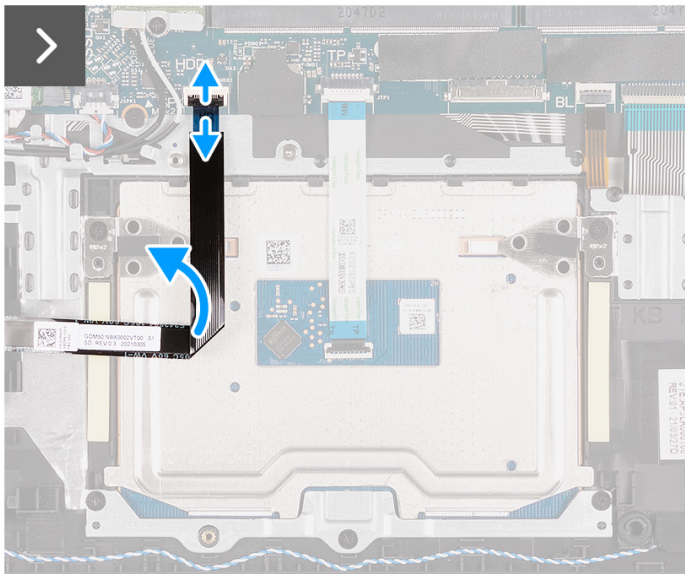
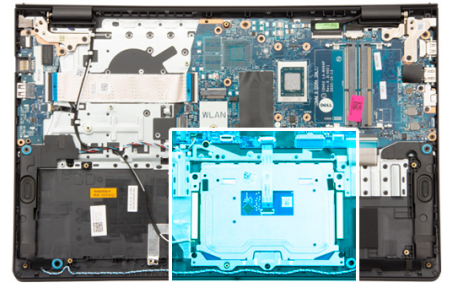

Steps

1. Remove the three (M2x2) screws that secure the touchpad bracket to the palm-rest and keyboard assembly.
2. Lift the touchpad bracket off the touchpad.
3. Open the latch and disconnect the touchpad Flexible Flat cable from the connector on the system board.
4. Remove the two screws (M2x2) that secure the touchpad to the palm-rest and keyboard assembly.
5. Lift the touchpad from the palm-rest and keyboard assembly along with the touchpad cable.

Installing the touchpad

 **CAUTION:** The information in this section is intended for authorized service technicians only.

Prerequisites

If you are replacing a component, remove the existing component before performing the installation process.

About this task

The following images indicate the location of the touchpad and provide a visual representation of the installation procedure.



5x
M2x2

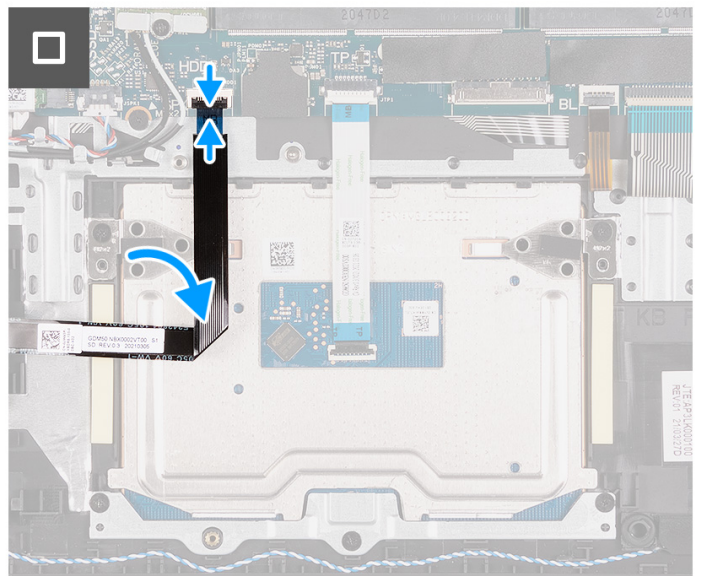
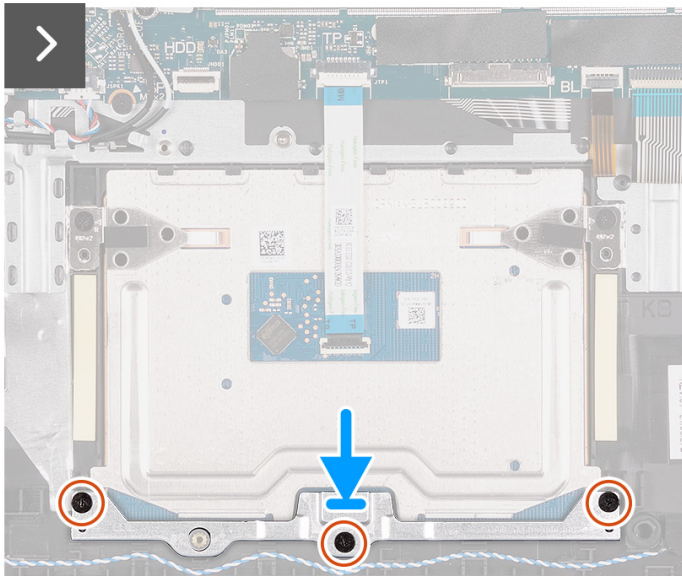
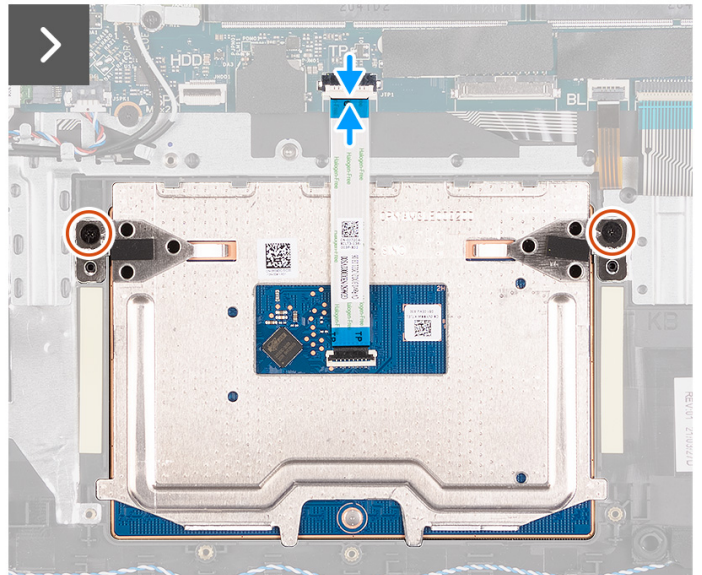
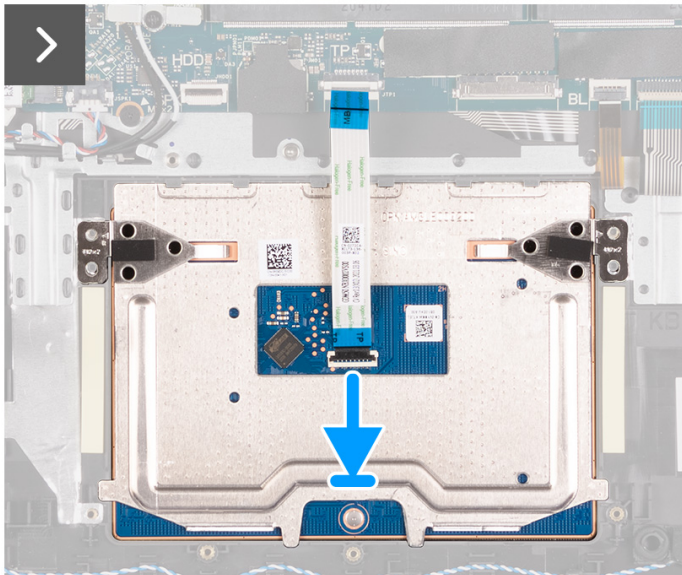
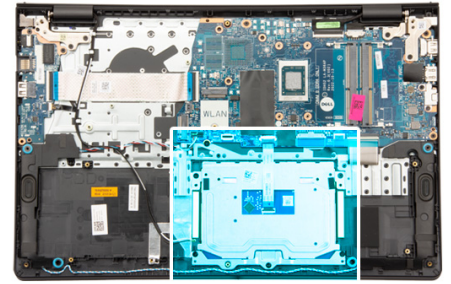

Steps

1. Place the touchpad into its slot on the palm-rest and keyboard assembly along with touchpad cable.
2. Align the screw holes on the touchpad to the screw holes on the palm-rest and keyboard assembly.
3. Replace the two (M2x2) screws that secure the touchpad to the palm-rest and keyboard assembly.
4. Connect the touchpad Flexible Flat cable to the connector on the system board and close the latch.
5. Place the touchpad bracket on the touchpad.
6. Align the screw holes on the touchpad bracket to the screw holes on the palm-rest and keyboard assembly.
7. Replace the three (M2x2) screws that secure the touchpad bracket to the palm-rest and keyboard assembly.

Next steps

1. Install the [3-cell battery](#) or [4-cell battery](#) (whichever applicable).
2. Install the [base cover](#).
3. Install the [SD card](#).
4. Follow the procedure in [After working inside your computer](#).

Heat sink

Removing the UMA heat sink

CAUTION: The information in this section is intended for authorized service technicians only.

Prerequisites

1. Follow the procedure in [Before working inside your computer](#).
2. Remove the [SD card](#).
3. Remove the [base cover](#).

About this task

- NOTE:** The heat sink may become hot during normal operation. Allow sufficient time for the heat sink to cool before you touch it.
- NOTE:** For maximum cooling of the processor, do not touch the heat transfer areas on the heat sink. The oils in your skin can reduce the heat transfer capability of the thermal grease.

The following images indicate the location of the UMA heat sink and provide a visual representation of the removal procedure.

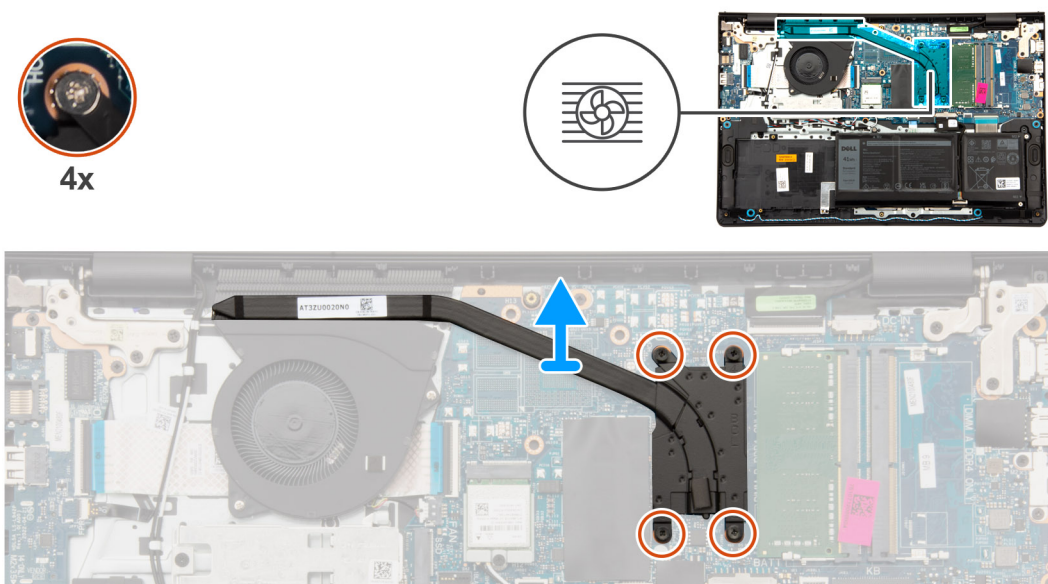

Steps

1. Loosen the four captive screws that secure the heat sink to the system board.
 - NOTE:** Loosen the captive screws in the reverse sequential order mentioned on the heat sink [4 > 3 > 2 > 1].
 - NOTE:** The number of screws varies depending on the configuration ordered.
2. Lift the heat sink from the system board.

Installing the UMA heat sink

CAUTION: The information in this section is intended for authorized service technicians only.

Prerequisites

If you are replacing a component, remove the existing component before performing the installation process.

About this task

NOTE: If either the system board or the heat sink is replaced, use the thermal grease provided in the kit to ensure that thermal conductivity is achieved.

The following images indicate the location of the UMA heat sink and provide a visual representation of the installation procedure.

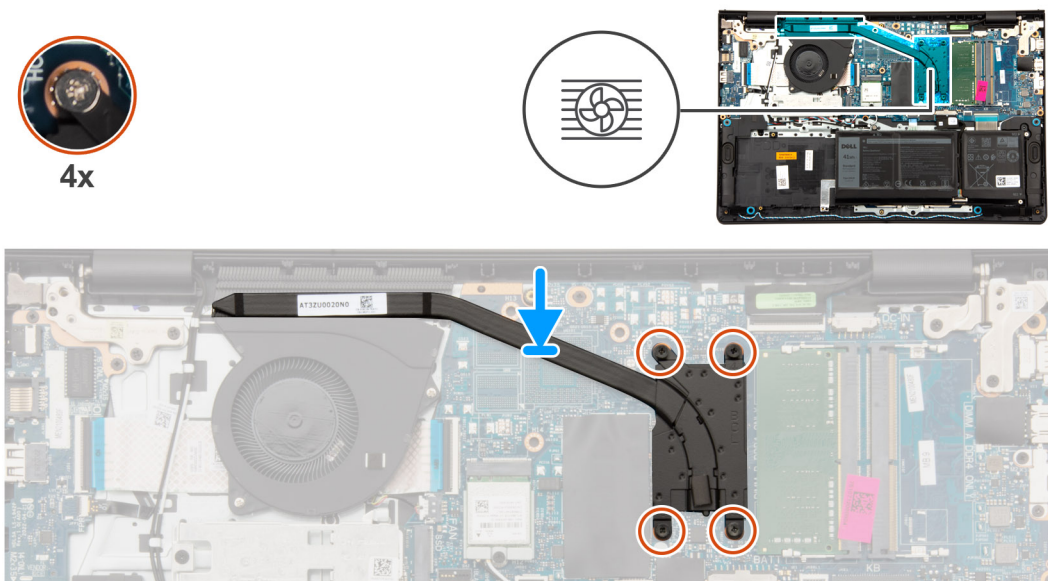

Steps

1. Place the heat sink on the system board.
2. Tighten the four captive screws that secure the heat sink to the system board.

NOTE: Tighten the captive screws in the sequential order mentioned on the heat sink [1 > 2 > 3 > 4].

NOTE: The number of screws varies depending on the configuration ordered.

Next steps

1. Install the [base cover](#).
2. Install the [SD card](#).
3. Follow the procedure in [After working inside your computer](#).

Removing the discrete heat sink

CAUTION: The information in this section is intended for authorized service technicians only.

Prerequisites

1. Follow the procedure in [Before working inside your computer](#).

2. Remove the [SD card](#).
3. Remove the [base cover](#).

About this task

- NOTE:** The heat sink may become hot during normal operation. Allow sufficient time for the heat sink to cool before you touch it.
- NOTE:** For maximum cooling of the processor, do not touch the heat transfer areas on the heat sink. The oils in your skin can reduce the heat transfer capability of the thermal grease.

The following images indicate the location of the discrete heat sink and provide a visual representation of the removal procedure.

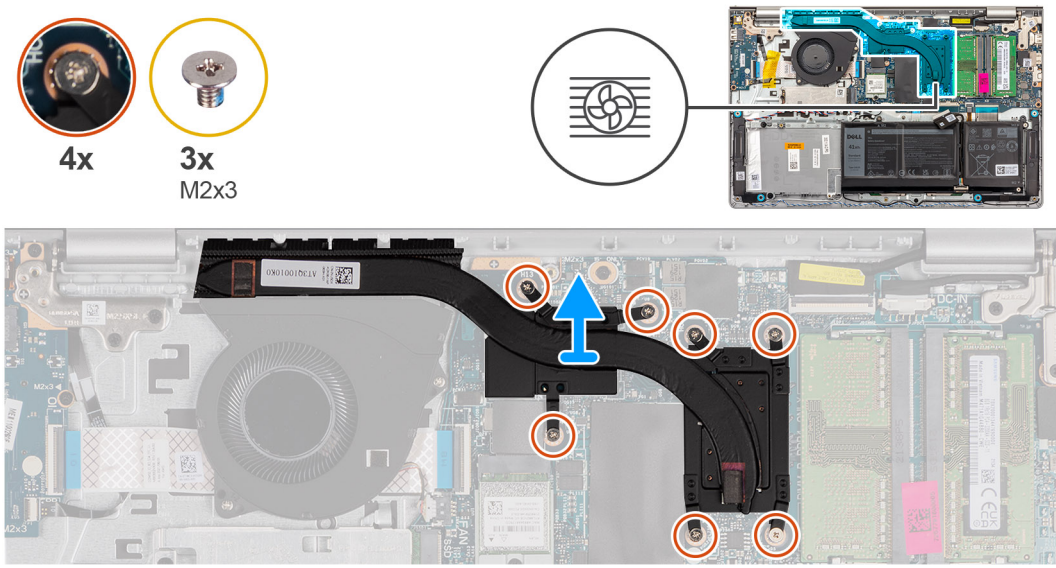

Steps

1. Remove the three (M2x3) screws and loose four captive screws that secure the heat sink to the system board.
 - NOTE:** Remove and loosen the captive screws in the reverse sequential order mentioned on the heat sink [7>6>5>4>3>2>1].
 - NOTE:** The number of screws varies depending on the configuration ordered.
2. Lift the heat sink from the system board.

Installing the discrete heat sink

CAUTION: The information in this section is intended for authorized service technicians only.

Prerequisites

If you are replacing a component, remove the existing component before performing the installation process.

About this task

- NOTE:** If either the system board or the heat sink is replaced, use the thermal grease provided in the kit to ensure that thermal conductivity is achieved.

The following images indicate the location of the discrete heat sink and provide a visual representation of the installation procedure.

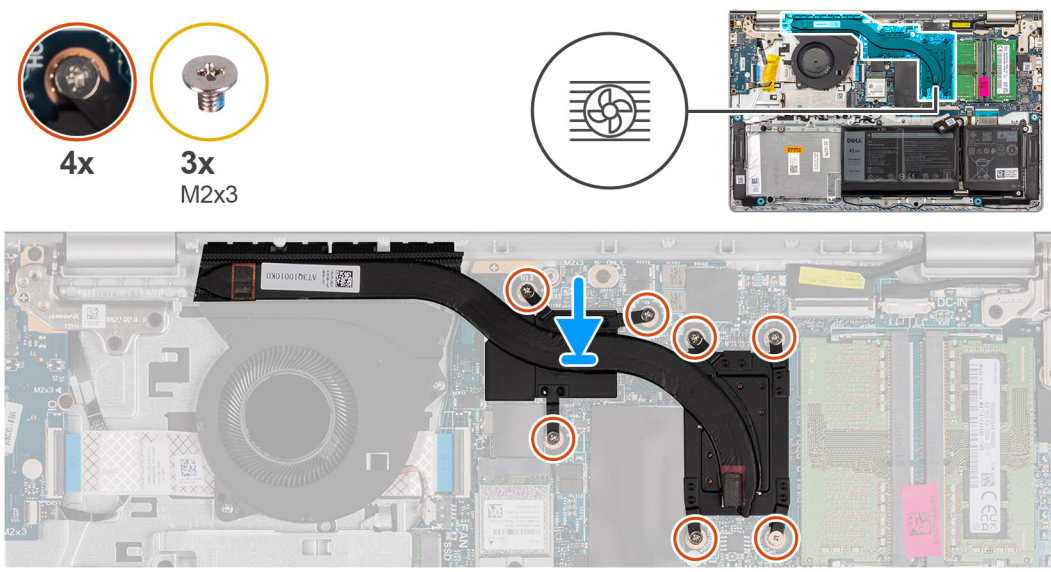

Steps

1. Place the heat sink on the system board.
2. Replace the three (M2x3) and tighten four captive screws that secure the heat sink to the system board.
 - i** **NOTE:** Replace and tighten the screws in the sequential order mentioned on the heat sink [1 > 2 > 3 > 4 > 5 > 6 > 7].
 - i** **NOTE:** The number of screws varies depending on the configuration ordered.

Next steps

1. Install the [base cover](#).
2. Install the [SD card](#).
3. Follow the procedure in [After working inside your computer](#).

I/O daughter board FFC

Removing the Input/Output daughter board FFC

⚠ CAUTION: The information in this section is intended for authorized service technicians only.

Prerequisites

1. Follow the procedure in [Before working inside your computer](#).
2. Remove the [SD card](#).
3. Remove the [base cover](#).
4. Remove the [fan](#).

About this task

The following image indicates the location of the Input/Output daughter board FFC and provides a visual representation of the removal procedure in an aluminum chassis.

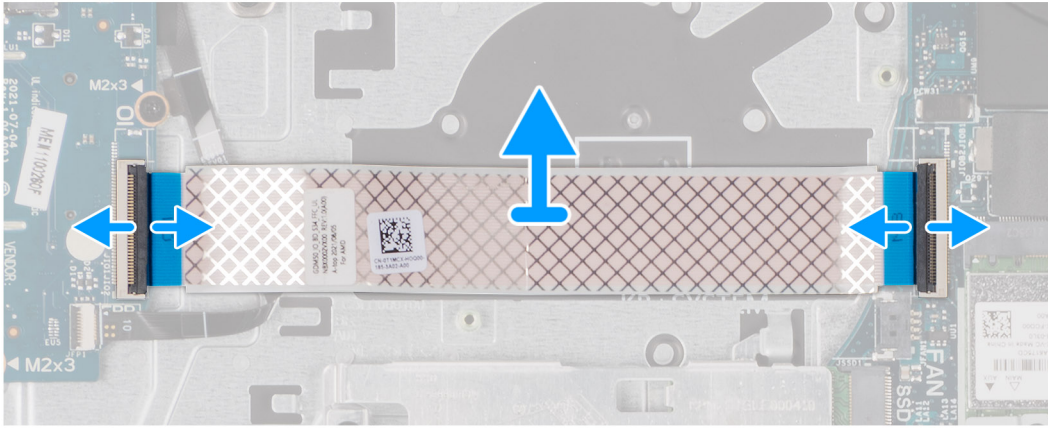
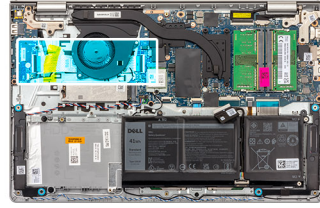

For systems shipped with a plastic chassis:

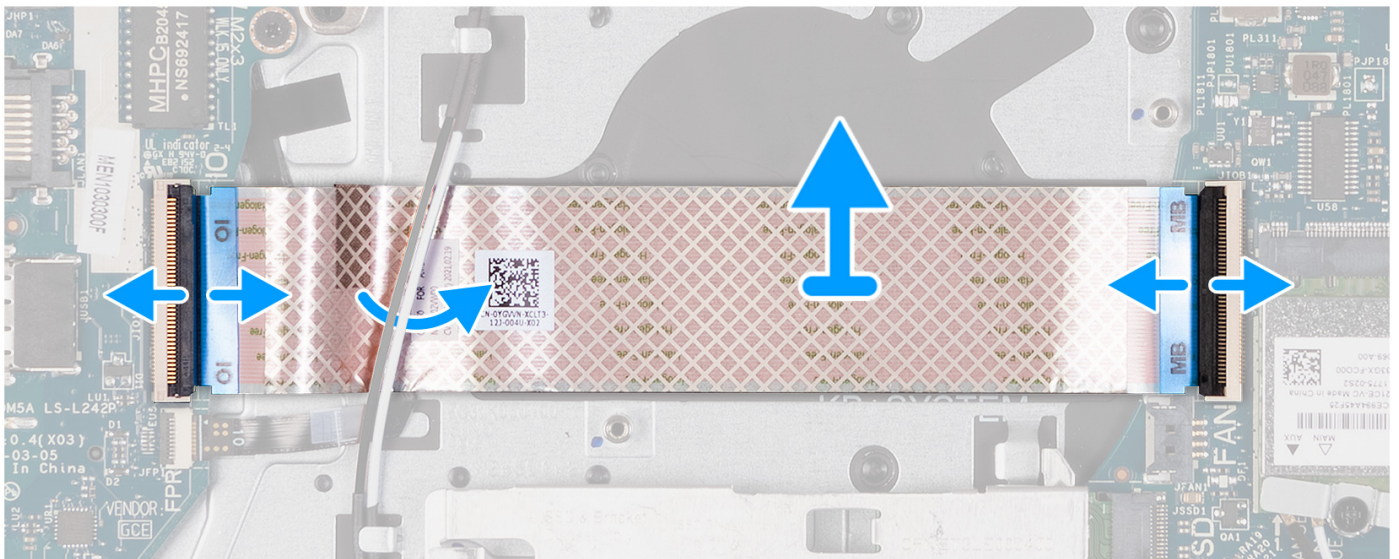
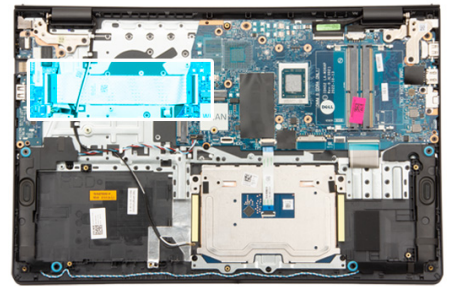

Steps

1. Open the latch and disconnect the I/O daughter board cable from the I/O board.
2. Open the latch and disconnect the I/O daughter board cable from the system board.
3. Lift the I/O daughter board cable off the palm-rest and keyboard assembly.

NOTE: For systems shipped with a plastic chassis, slide the I/O daughter board cable underneath the wireless card antenna cables and lift off the palm-rest and keyboard assembly.

Installing the Input/Output daughter board FFC

CAUTION: The information in this section is intended for authorized service technicians only.

Prerequisites

If you are replacing a component, remove the existing component before performing the installation process.

About this task

The following images indicate the location of the I/O daughter board FFC and provide a visual representation of the installation procedure in a system shipped with aluminum chassis:

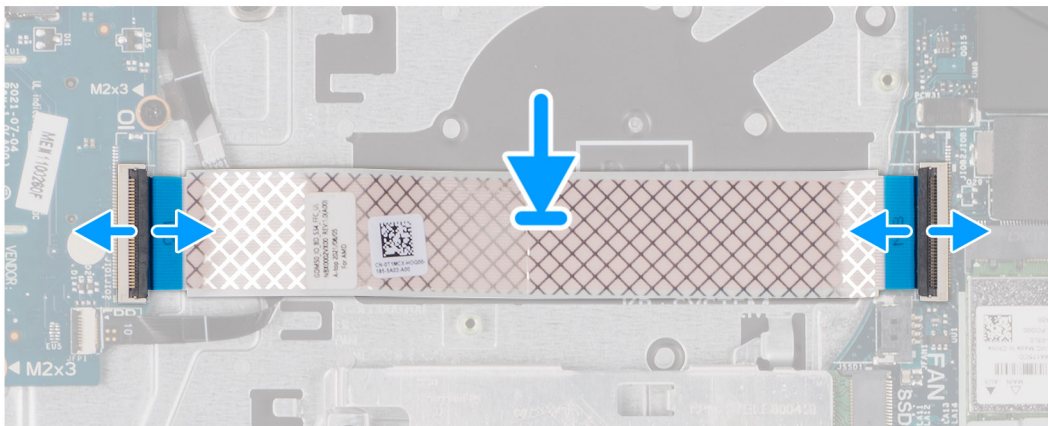
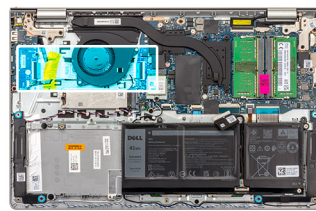

For systems shipped with a plastic chassis:

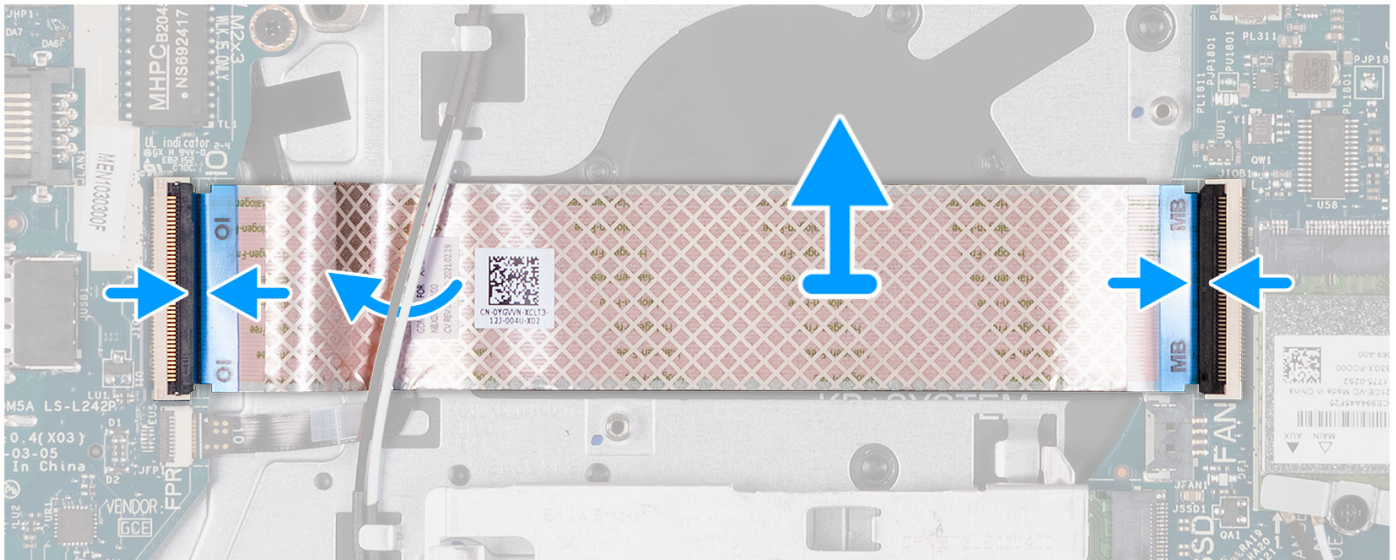
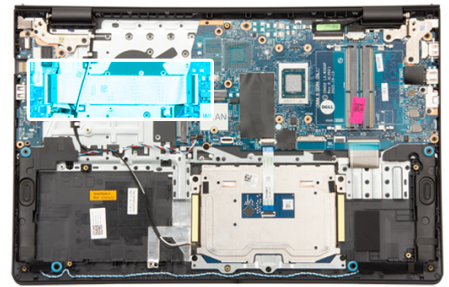

Steps

1. Place the I/O daughter board FFC on the palm-rest and keyboard assembly.
For systems shipped with a plastic chassis, slide and place the I/O daughter board FFC underneath the wireless card antenna cables on the palm-rest and keyboard assembly.
2. Connect the I/O daughter board FFC the connector on the I/O board.
3. Connect the I/O daughter board FFC the connector on the system board.

Next steps

1. Install the [fan](#).
2. Install the [base cover](#).
3. Install the [SD card](#).
4. Follow the procedure in [After working inside your computer](#).

I/O board

Removing the Input/Output board

⚠ CAUTION: The information in this section is intended for authorized service technicians only.

Prerequisites

1. Follow the procedure in [Before working inside your computer](#).
2. Remove the [SD card](#).

3. Remove the [base cover](#).

About this task

The following images indicate the location of the Input/Output board and provide a visual representation of the removal procedure.



2x
M2x3.5

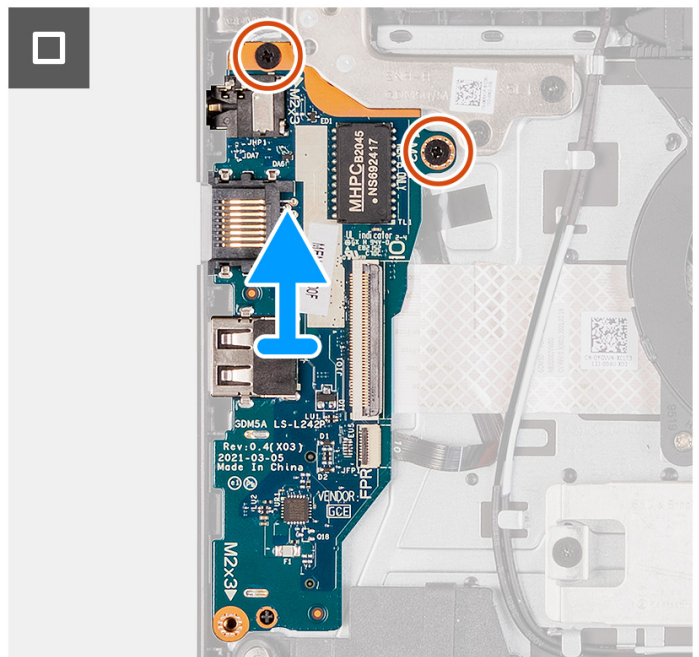
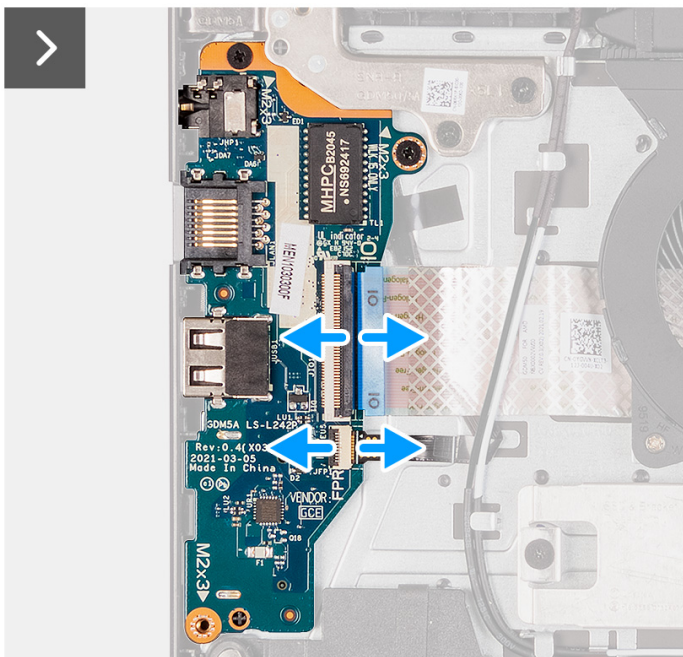

Steps

1. Open the latch and disconnect the I/O board cable from the I/O board.
2. Open the latch and disconnect the fingerprint-reader board cable from the I/O board (if applicable).
3. Remove the two (M2x3.5) screws that secure the I/O board to the palm-rest and keyboard assembly.
4. Lift the I/O board off the palm-rest and keyboard assembly.

Installing the Input/Output board

CAUTION: The information in this section is intended for authorized service technicians only.

Prerequisites

If you are replacing a component, remove the existing component before performing the installation process.

About this task

The following images indicate the location of the I/O board and provide a visual representation of the installation procedure.



2x
M2x3.5

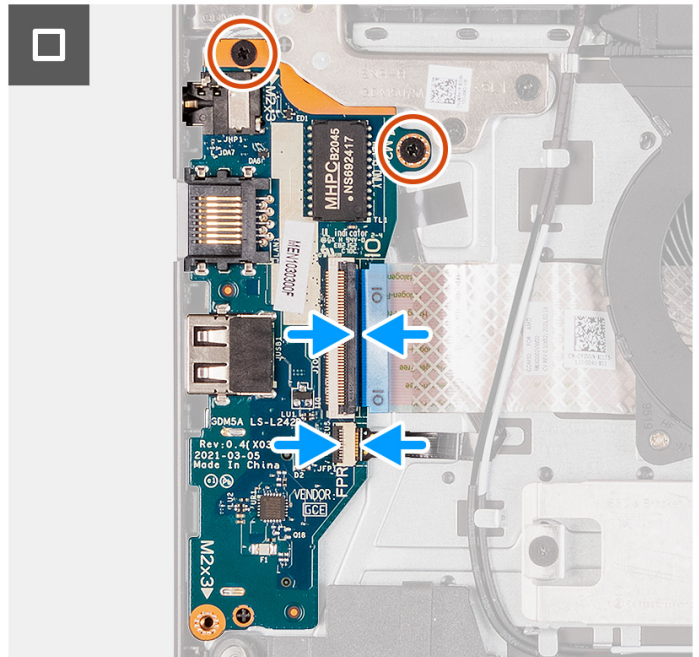
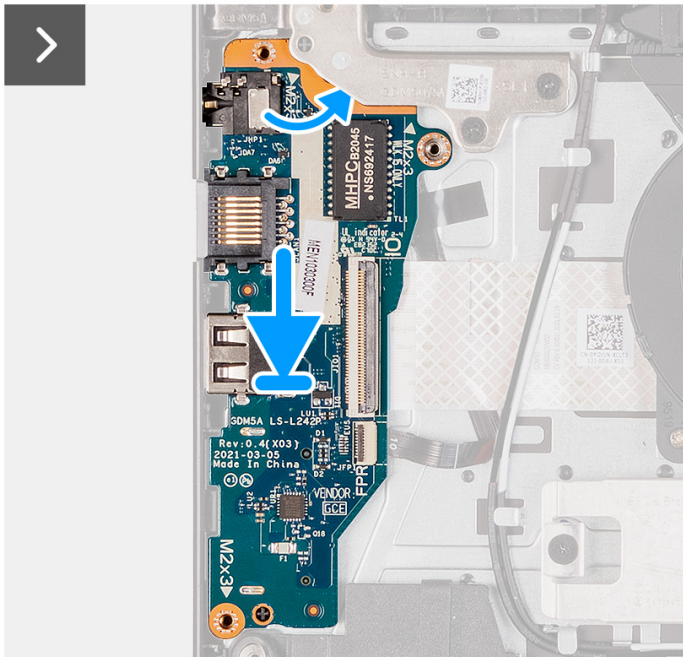
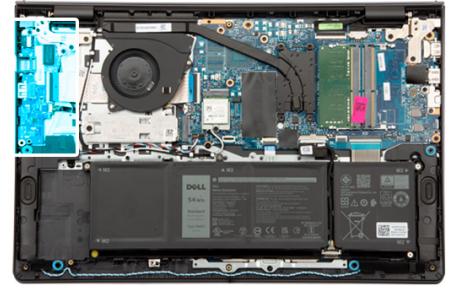

Steps

1. Place the I/O board on the palm-rest and keyboard assembly.
2. Align the screw holes on the I/O board to the screw holes on the palm-rest and keyboard assembly.
3. Replace the two (M2x3.5) screws that secure the I/O board to the palm-rest and keyboard assembly.
4. Connect the fingerprint-reader board cable to the connector on the I/O board and close the latch (if applicable).
5. Connect the I/O board power cable to the connector on the I/O board and close the latch.

Next steps

1. Install the [base cover](#).
2. Install the [SD card](#).
3. Follow the procedure in [After working inside your computer](#).

Display assembly

Removing the display assembly

 **CAUTION:** The information in this section is intended for authorized service technicians only.

 **CAUTION:** The maximum operating angle for the display-panel hinge is 135 degrees.

Prerequisites

1. Follow the procedure in [Before working inside your computer](#).
2. Remove the [SD card](#).
3. Remove the [base cover](#).
4. Remove the [wireless card](#).

About this task

The following images indicate the location of the display assembly and provide a visual representation of the removal procedure.



4x
M2.5x5

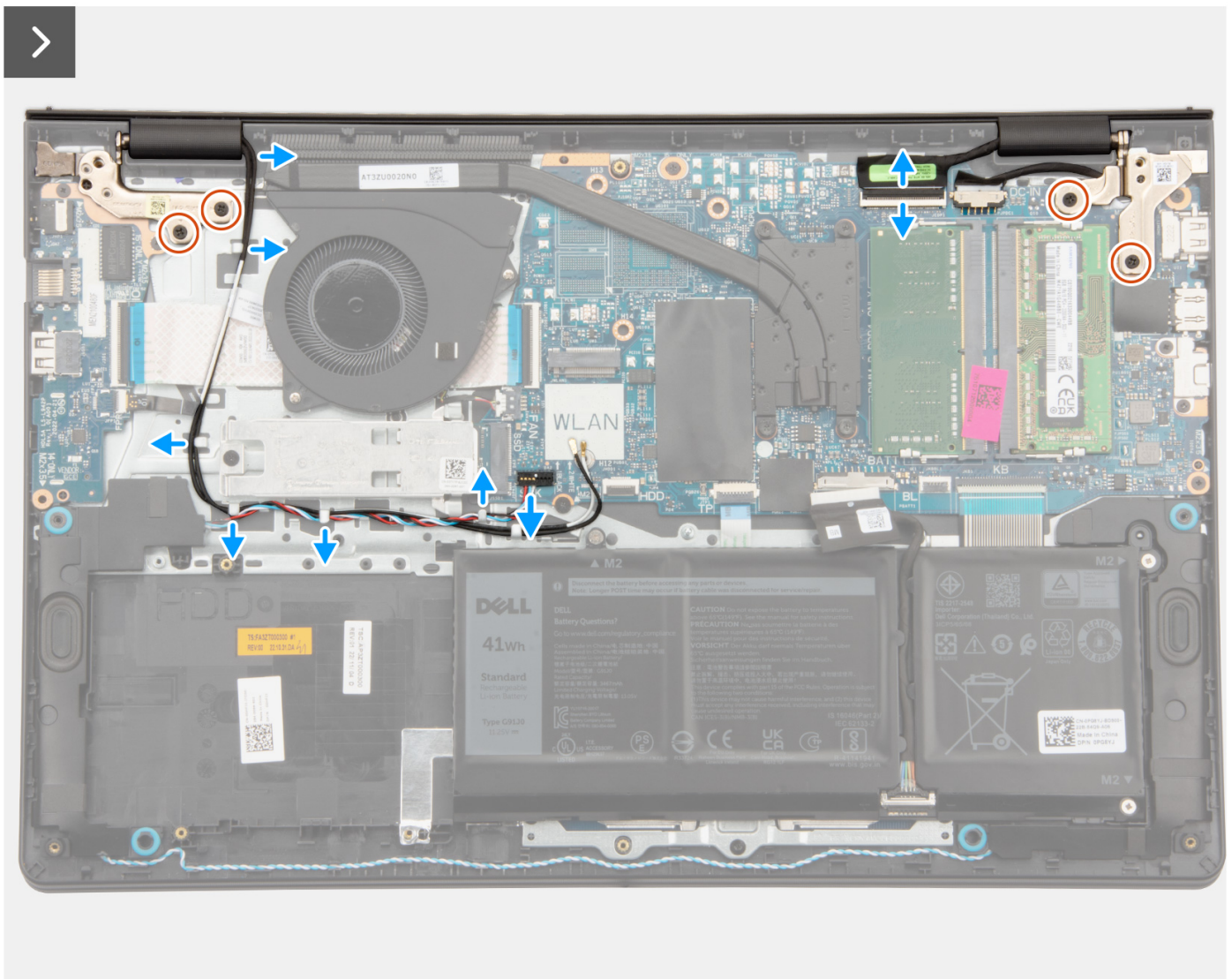
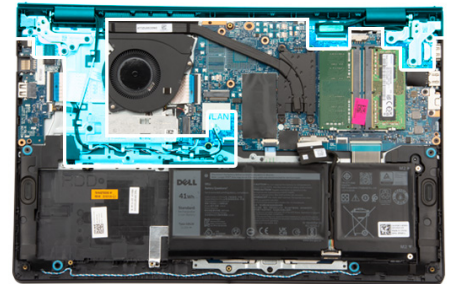

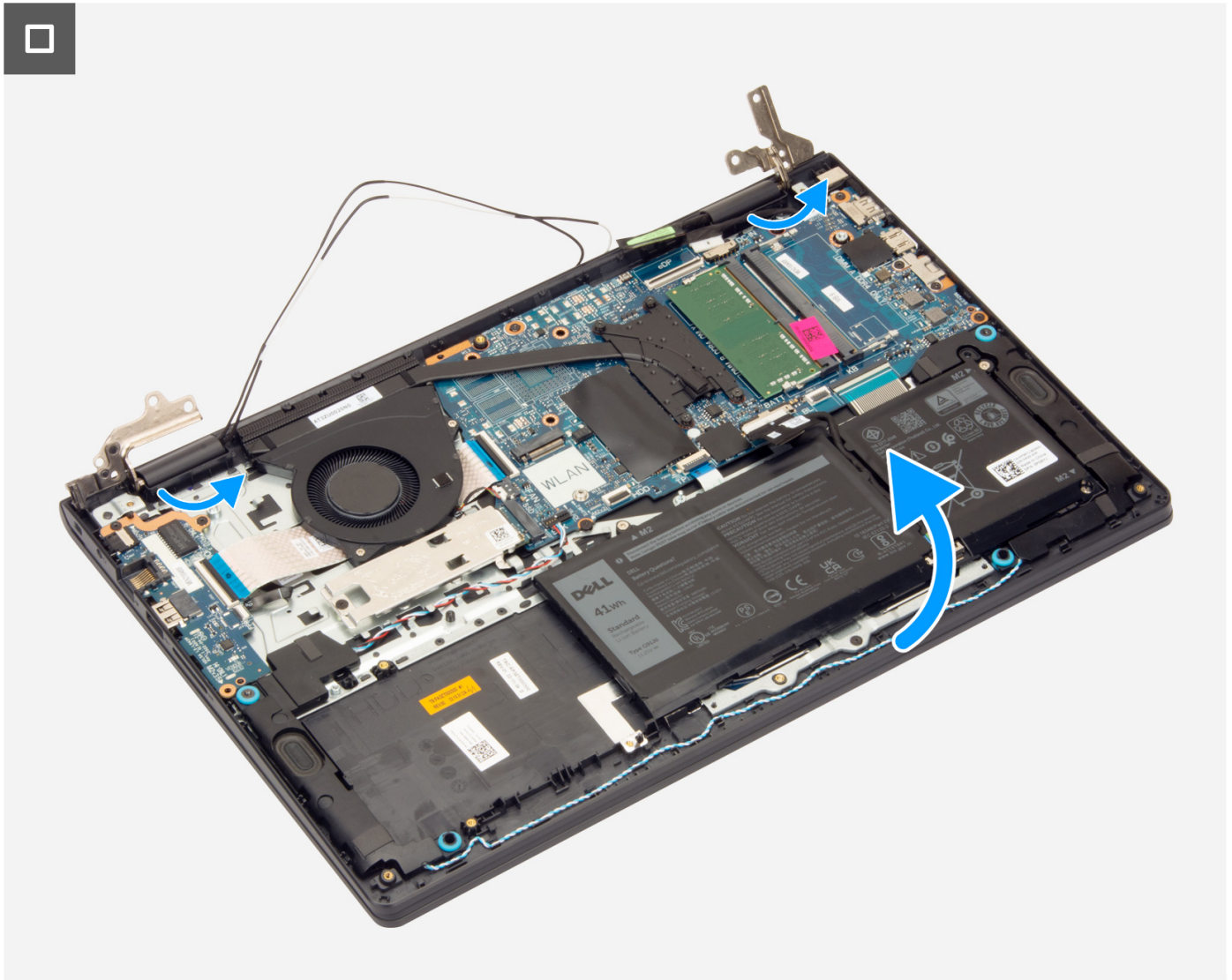



Steps

1. Remove the four (M2.5x5) screws that secure the display hinges to the palm-rest and keyboard assembly.
2. Disconnect the display cable and the speaker cable from the system board (for systems with plastic chassis).
i **NOTE:** Disconnect only the display cable from the system board for systems with aluminum chassis.
3. Unroute the speaker cable from the routing guides on the palm-rest and keyboard assembly.
4. Unroute the WLAN antenna cables from the routing guides on the palm-rest and keyboard assembly (for systems with plastic chassis).
5. Open the display hinges at an angle of 90 degrees, and place the system on a flat surface.
6. Remove the display assembly from the palm-rest and keyboard assembly.
i **NOTE:** For systems with an aluminum chassis, the display assembly is a Hinge-Up Design (HUD) assembly and cannot be further disassembled once it is removed from the bottom chassis. If any components in the display assembly malfunction and needs replacement, the entire display assembly has to be replaced.

Installing the display assembly

△ CAUTION: The information in this section is intended for authorized service technicians only.

△ CAUTION: The maximum operating angle for the display-panel hinge is 135 degrees.

Prerequisites

If you are replacing a component, remove the existing component before performing the installation process.

About this task

The following images indicate the location of the display assembly and provide a visual representation of the installation procedure.



4x
M2.5x5

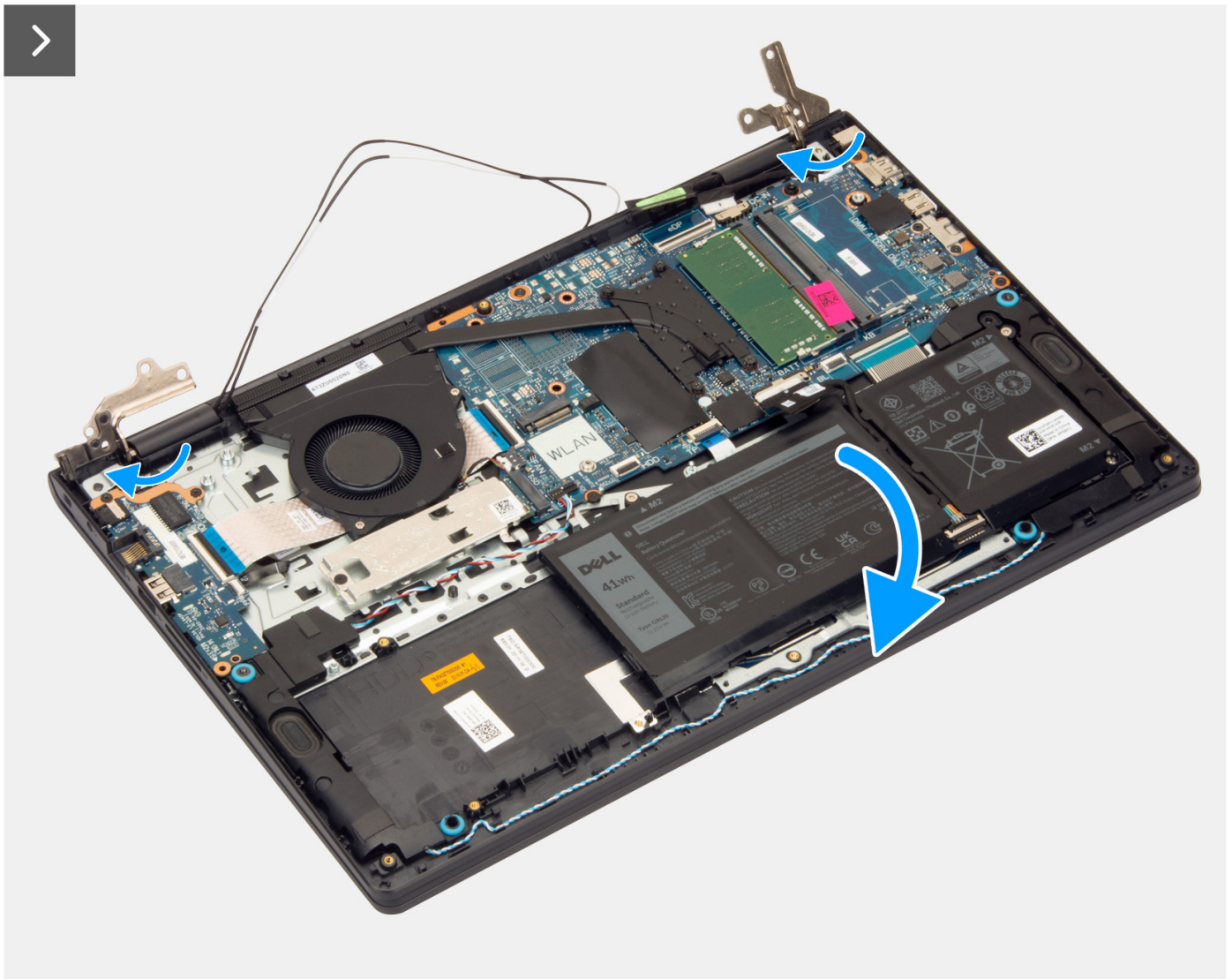
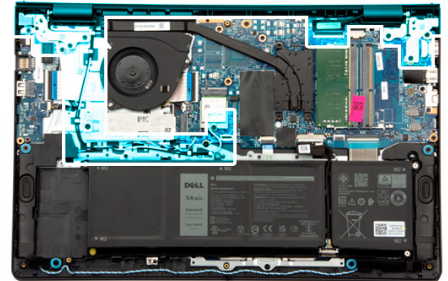

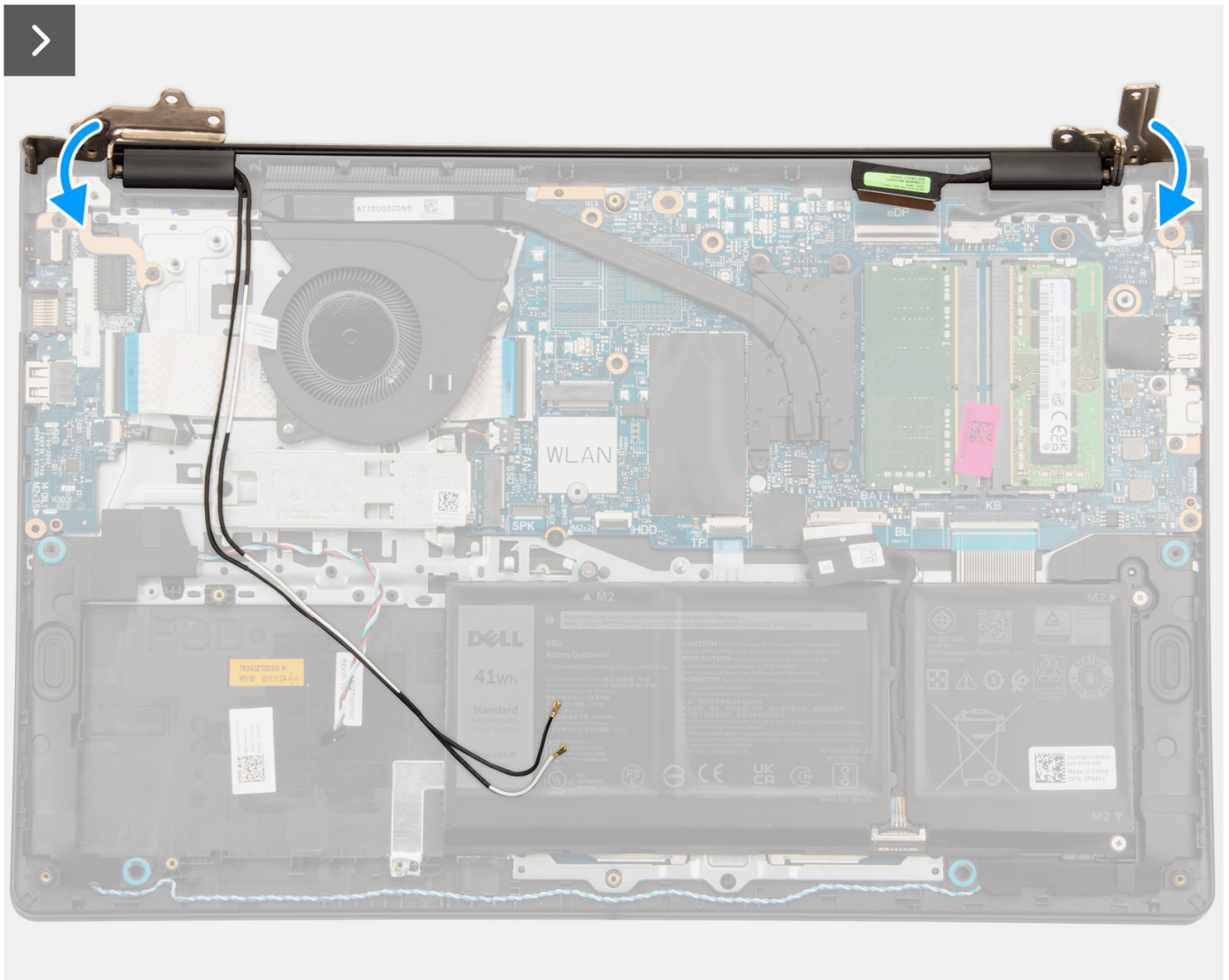

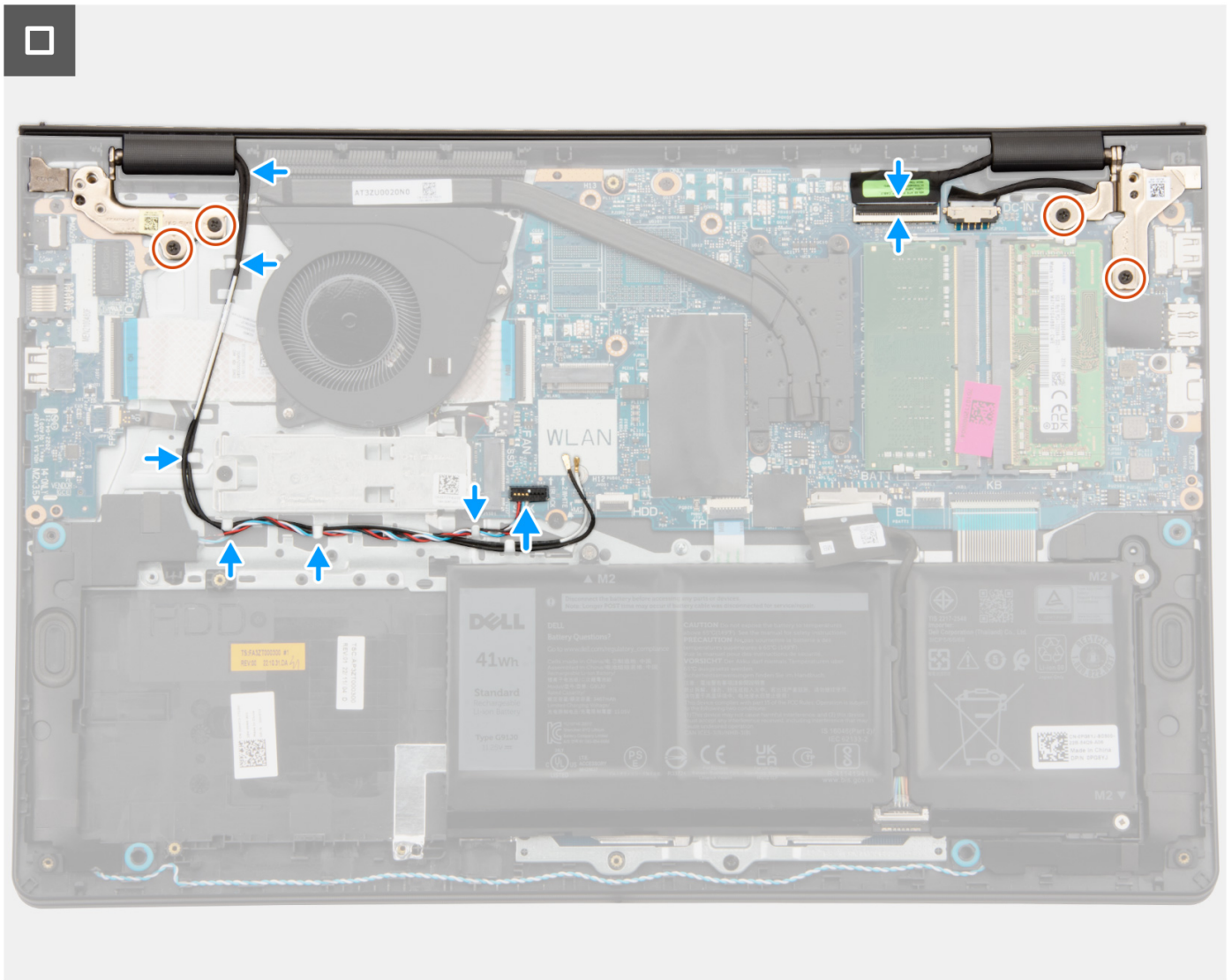

Steps

1. Slide the display assembly at an angle, and place the display assembly on the palm-rest and keyboard assembly.
2. Gently press down on the display hinges to align the screw holes on the display hinges with the screw holes on the palm-rest and keyboard assembly.
3. Replace the four (M2.5x5) screws that secure the display hinges to the palm-rest and keyboard assembly.
4. Route the WLAN antenna cables through the routing guides on the palm rest, along the left side of the fan and below the speaker cable.

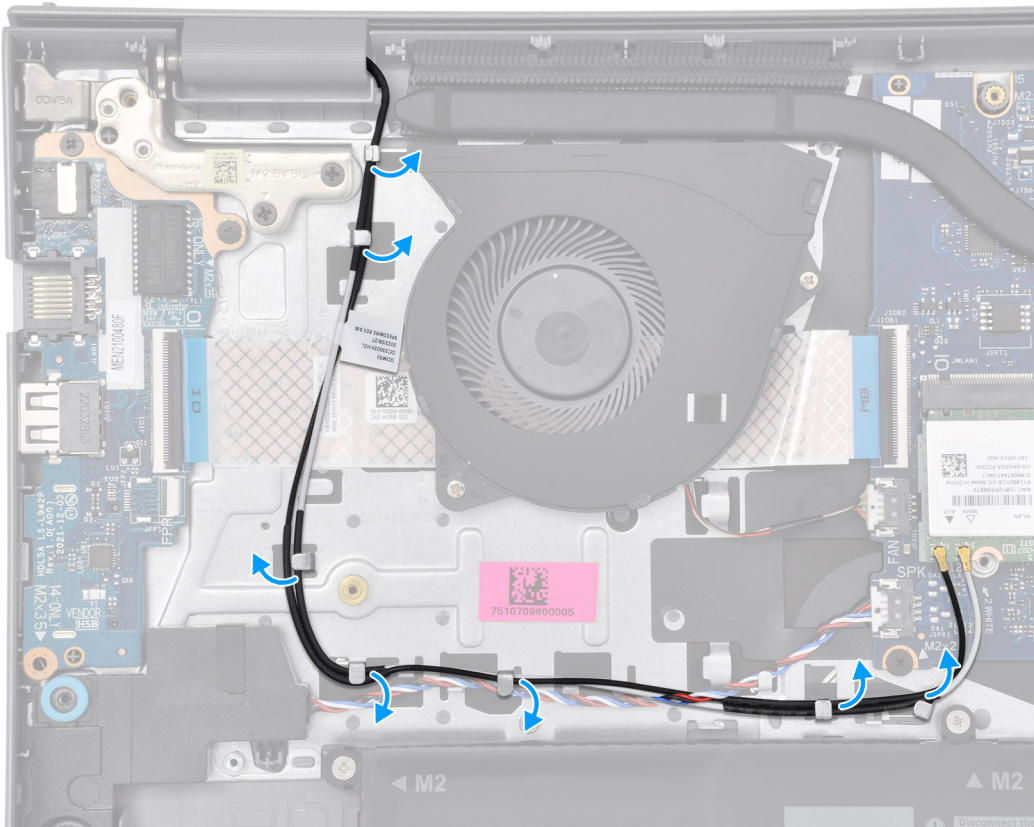

5. Route the speaker cable through the routing guides on the palm-rest and keyboard assembly.

i **NOTE:** Ensure to route the speaker cable over the WLAN antenna cables.

6. Connect the display cable to the connector on the system board.

Next steps

1. Install the [wireless card](#).
2. Install the [base cover](#).
3. Install the [SD card](#).
4. Follow the procedure in [After working inside your computer](#).

Hinge caps

Removing the hinge caps

⚠ CAUTION: The information in this section is intended for authorized service technicians only.

i **NOTE:** This procedure is applicable for systems shipped with a plastic chassis only.

Prerequisites

1. Follow the procedure in [Before working inside your computer](#).
2. Remove the [SD card](#).
3. Remove the [base cover](#).
4. Remove the [wireless card](#).
5. Remove the [display assembly](#).

About this task

The following images indicate the location of the hinge caps and provide a visual representation of the installation procedure.

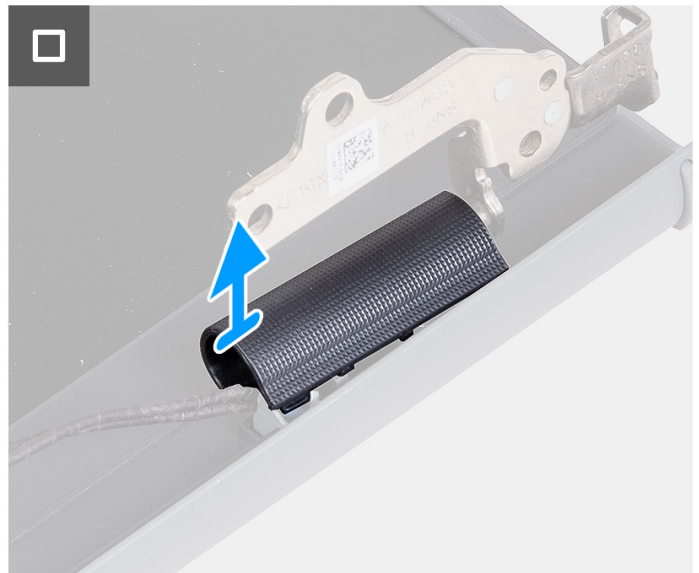
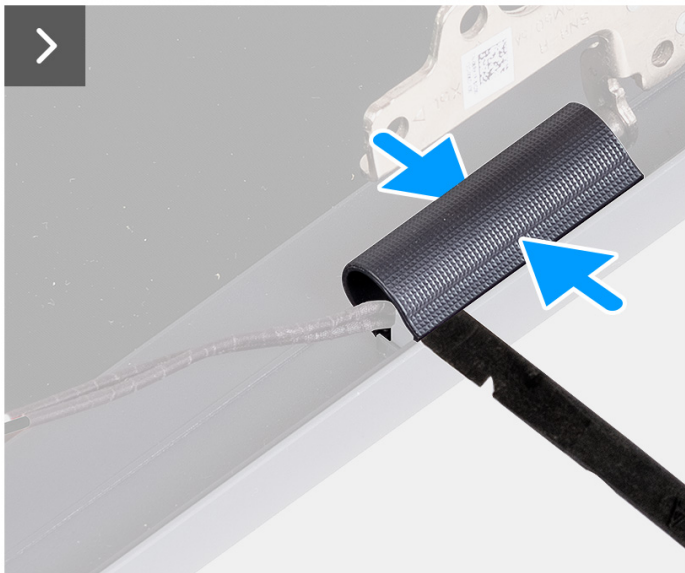
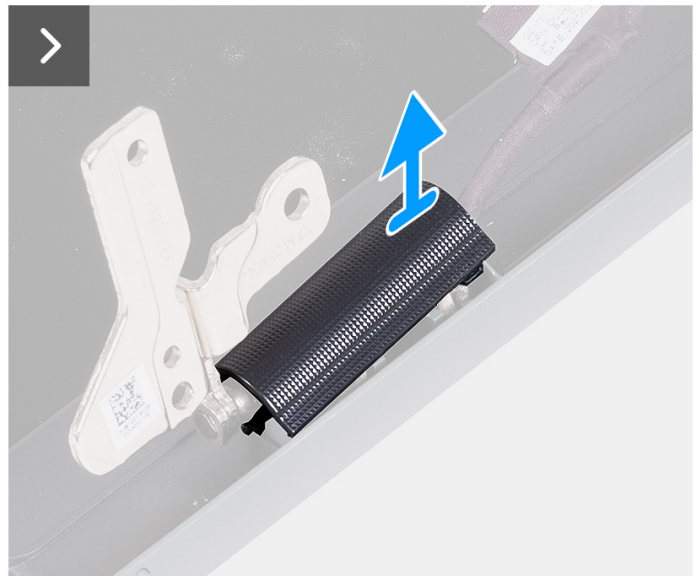
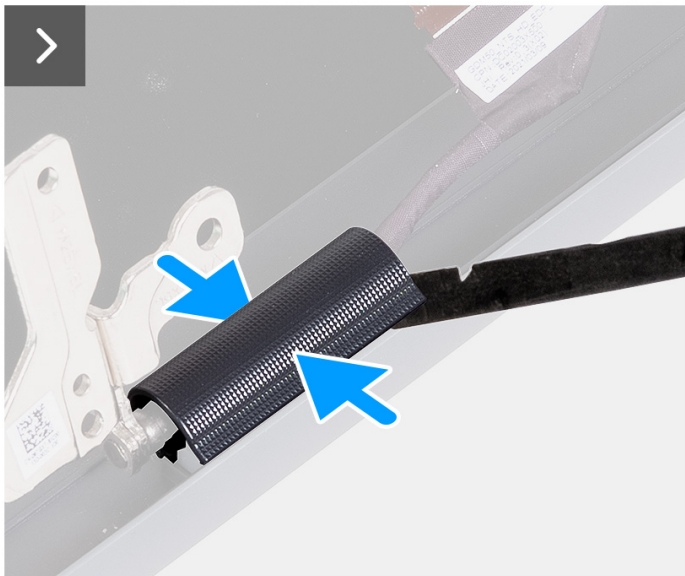

Steps

1. Place the display assembly on a clean, flat surface and gently open the display hinges to at least 90 degrees.



2. Using a plastic scribe, pry open the left display-hinge cap from its right side and remove it from the left display hinge.
3. Using a plastic scribe, pry open the right display-hinge cap from its left side and remove it from the right display hinge.



Installing the hinge caps

CAUTION: The information in this section is intended for authorized service technicians only.

NOTE: This procedure is applicable for systems shipped with a plastic chassis only.

Prerequisites

If you are replacing a component, remove the existing component before performing the installation procedure.

About this task

The following images indicate the location of the hinge caps and provide a visual representation of the installation procedure.

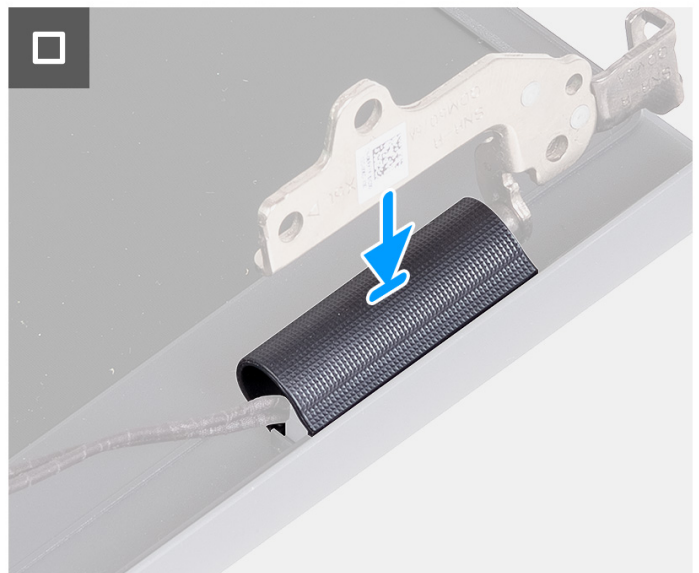
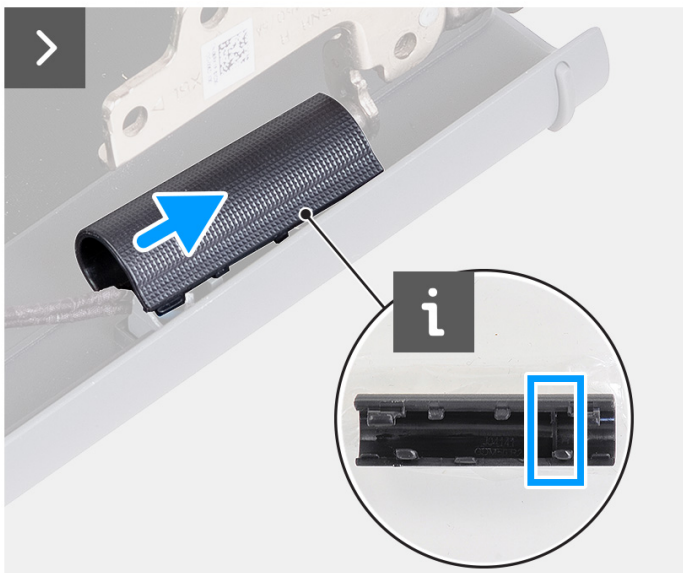
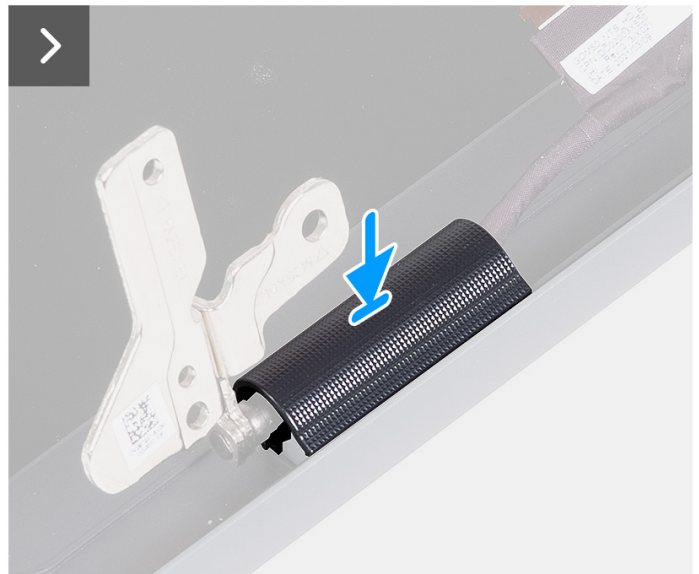
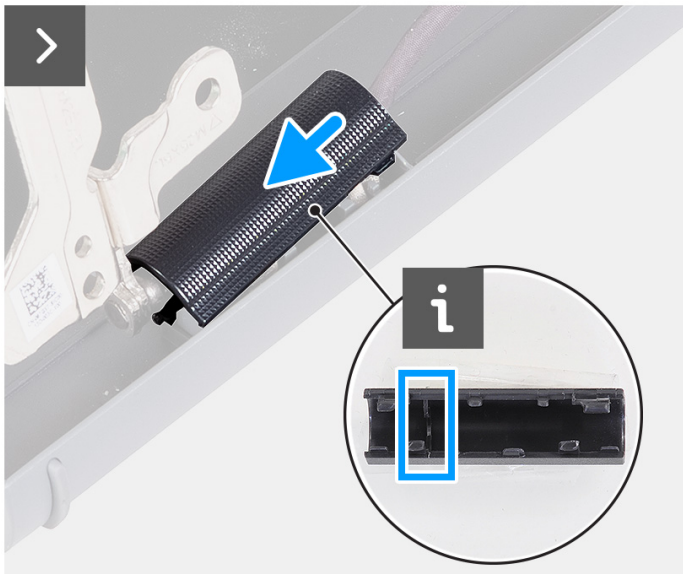
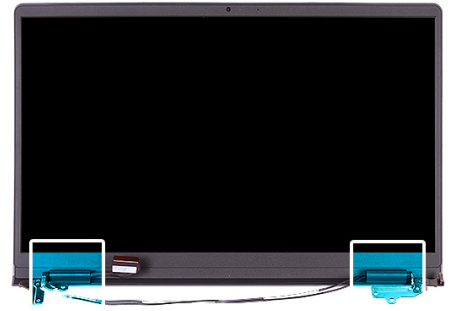

Steps

1. Align the rib inside the left and right hinge caps to the outer sides.
2. Push the right and left hinge caps down until it clicks in place.



Next steps

1. Install the [display assembly](#).
2. Install the [wireless card](#).
3. Install the [base cover](#).
4. Install the [SD card](#).
5. Follow the procedure in [After working inside your computer](#).

Display bezel

Removing the display bezel

CAUTION: The information in this section is intended for authorized service technicians only.

NOTE: This procedure is applicable for systems shipped with a plastic chassis only.

Prerequisites

1. Follow the procedure in [Before working inside your computer](#).
2. Remove the [SD card](#).
3. Remove the [base cover](#).
4. Remove the [wireless card](#).
5. Remove the [display assembly](#).
6. Remove the [hinge caps](#).

About this task

The following images indicate the location of the display bezel and provide a visual representation of the removal procedure.

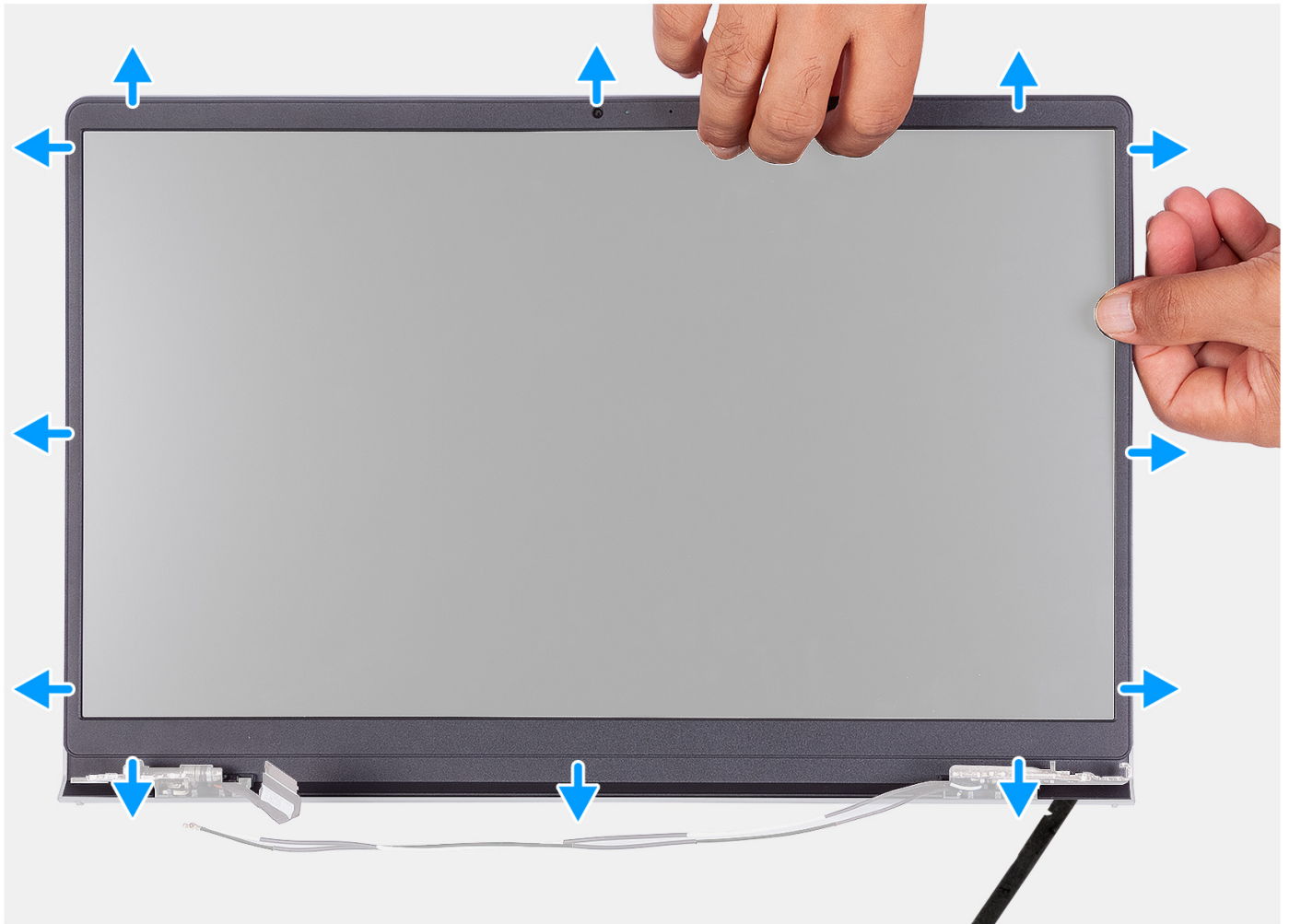

Steps

1. Using a plastic scribe, pry open the display bezel from the outer edge of openings at the bottom side of the display assembly, near the display hinges.

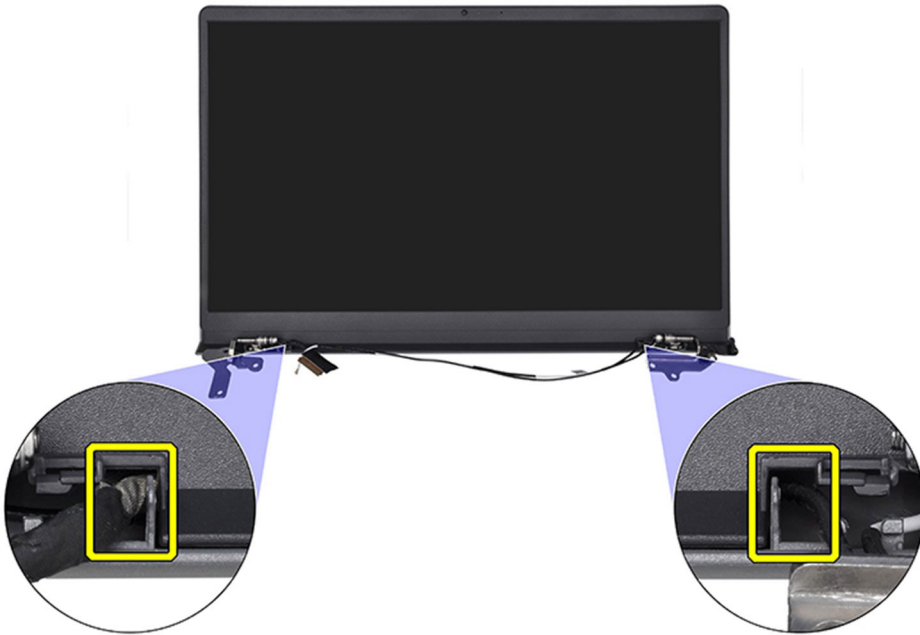

2. Pry open the display bezel from the inner edge at the top side of the display assembly.
3. Continue to pry open the outer edge of the bottom side of the display bezel.
4. Pry open the display bezel from the inner edge at the bottom side of the display assembly.



5. Lift and remove the display bezel from the display assembly.

i **NOTE:** DO NOT use a scribe or any other objects to pry up the display bezel as shown the images as the pressure applied on the display panel by the scribe can damage the display panel.



Installing the display bezel

CAUTION: The information in this section is intended for authorized service technicians only.

NOTE: This procedure is applicable for systems shipped with a plastic chassis only.

Prerequisites

If you are replacing a component, remove the existing component before performing the installation procedure.

About this task

The following image indicates the location of the display bezel and provides a visual representation of the installation procedure.



Steps

Align the display bezel with the display back-cover and antenna assembly, and then gently snap the display bezel into place.

Next steps

1. Install the [hinge caps](#).
2. Install the [display assembly](#).
3. Install the [wireless card](#).
4. Install the [base cover](#).
5. Install the [SD card](#).
6. Follow the procedure in [After working inside your computer](#).

Hinges

Removing the hinges

 **CAUTION:** The information in this section is intended for authorized service technicians only.

Prerequisites

 **NOTE:** This procedure is applicable for systems with a plastic chassis only.

1. Follow the procedure in [Before working inside your computer](#).
2. Remove the [SD card](#).
3. Remove the [base cover](#).
4. Remove the [wireless card](#).
5. Remove the [display assembly](#).
6. Remove the [hinge caps](#).
7. Remove the [display bezel](#).

About this task

The following images indicate the location of the hinge caps and provide a visual representation of the installation procedure.



6x
M2.5x3.8

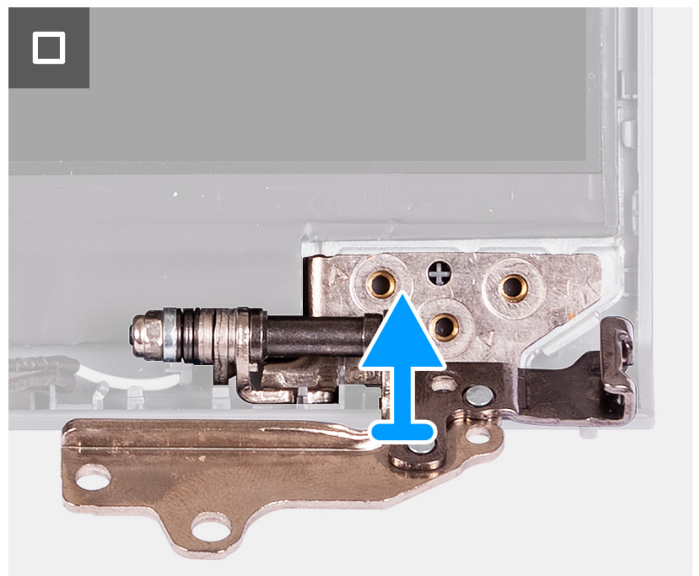
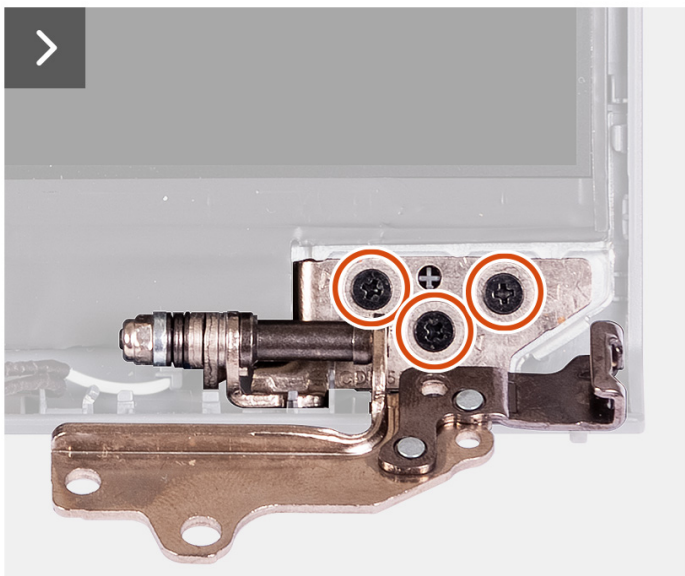
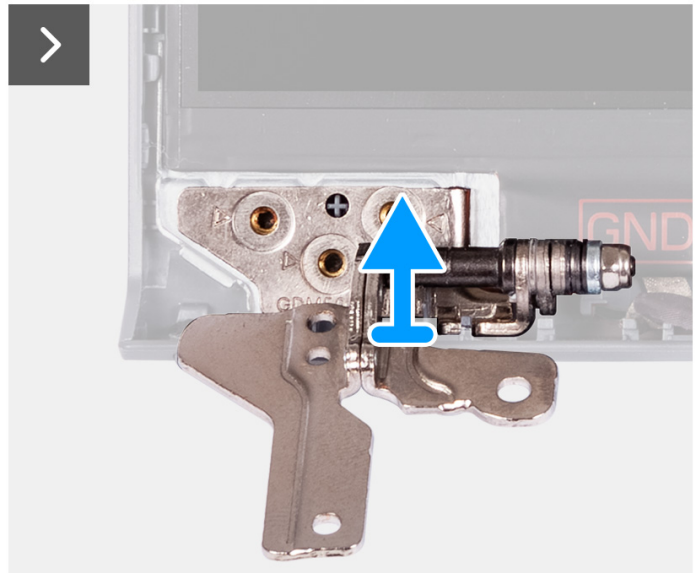

Steps

1. Remove the three (M2.5x3.8) screws from the left hinge.
2. Lift and remove the left hinge from the display assembly.
3. Remove the three (M2.5x3.8) screws from the right hinge.
4. Lift and remove the right hinge from the display assembly.

Installing the hinges

 **CAUTION:** The information in this section is intended for authorized service technicians only.

 **NOTE:** This procedure is applicable for systems shipped with a plastic chassis only.

Prerequisites

If you are replacing a component, remove the existing component before performing the installation procedure.

About this task

The following images indicate the location of the hinges and provide a visual representation of the installation procedure.



6x
M2.5x3.8

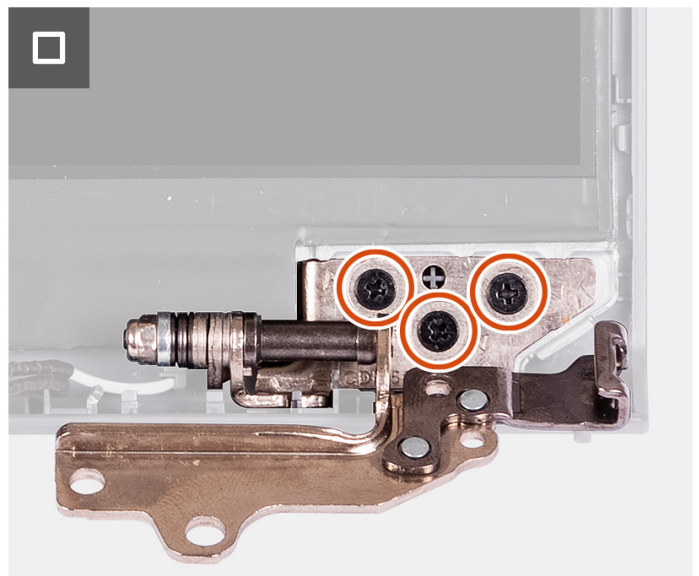
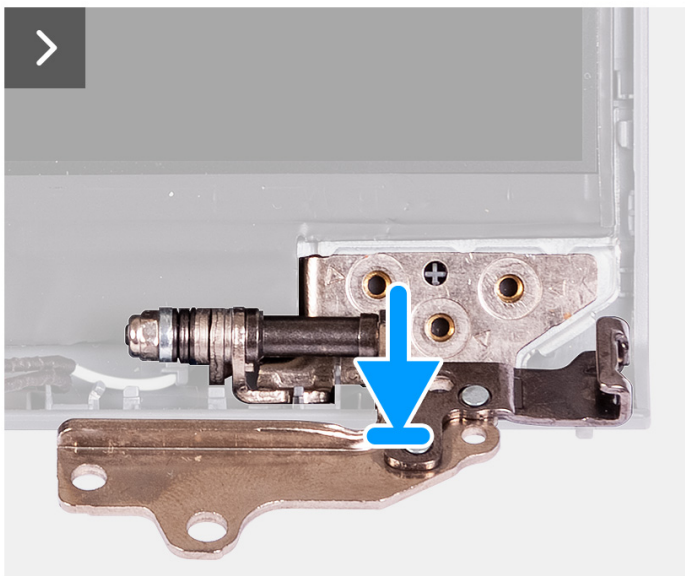
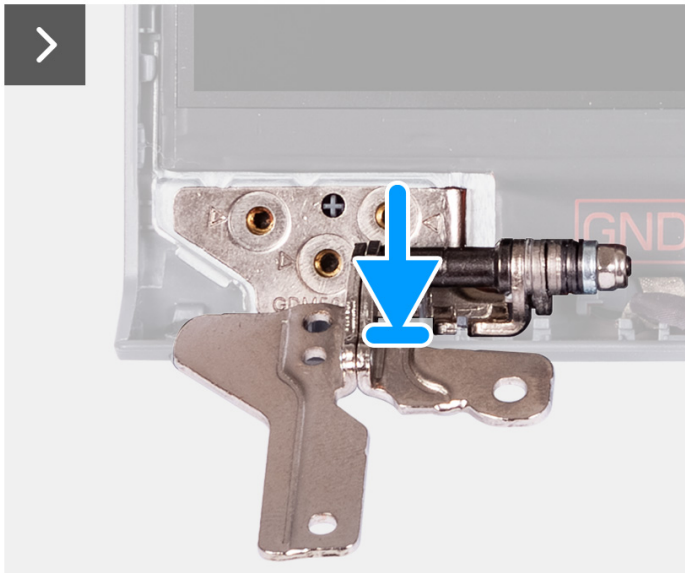

Steps

1. Align and place the left hinge on the display assembly.
2. Install the three (M2.5x3.8) screws to secure the hinge to the display panel and back cover.
3. Align and place the right hinge on the display assembly.
4. Install the three (M2.5x3.8) screws to secure the hinge to the display panel and back cover.

Next steps

1. Install the [display bezel](#).

2. Install the [hinge caps](#).
3. Install the [display assembly](#).
4. Install the [wireless card](#).
5. Install the [base cover](#).
6. Install the [SD card](#).
7. Follow the procedure in [After working inside your computer](#).

Display panel

Removing the display panel

 **CAUTION:** The information in this section is intended for authorized service technicians only.

 **NOTE:** This procedure is applicable for systems shipped with a plastic chassis only.

Prerequisites

1. Follow the procedure in [Before working inside your computer](#).
2. Remove the [SD card](#).
3. Remove the [base cover](#).
4. Remove the [wireless card](#).
5. Remove the [display assembly](#).
6. Remove the [hinge caps](#).
7. Remove the [display bezel](#).
8. Remove the [hinges](#).

About this task

The following images indicate the location of the display panel and provide a visual representation of the removal procedure.

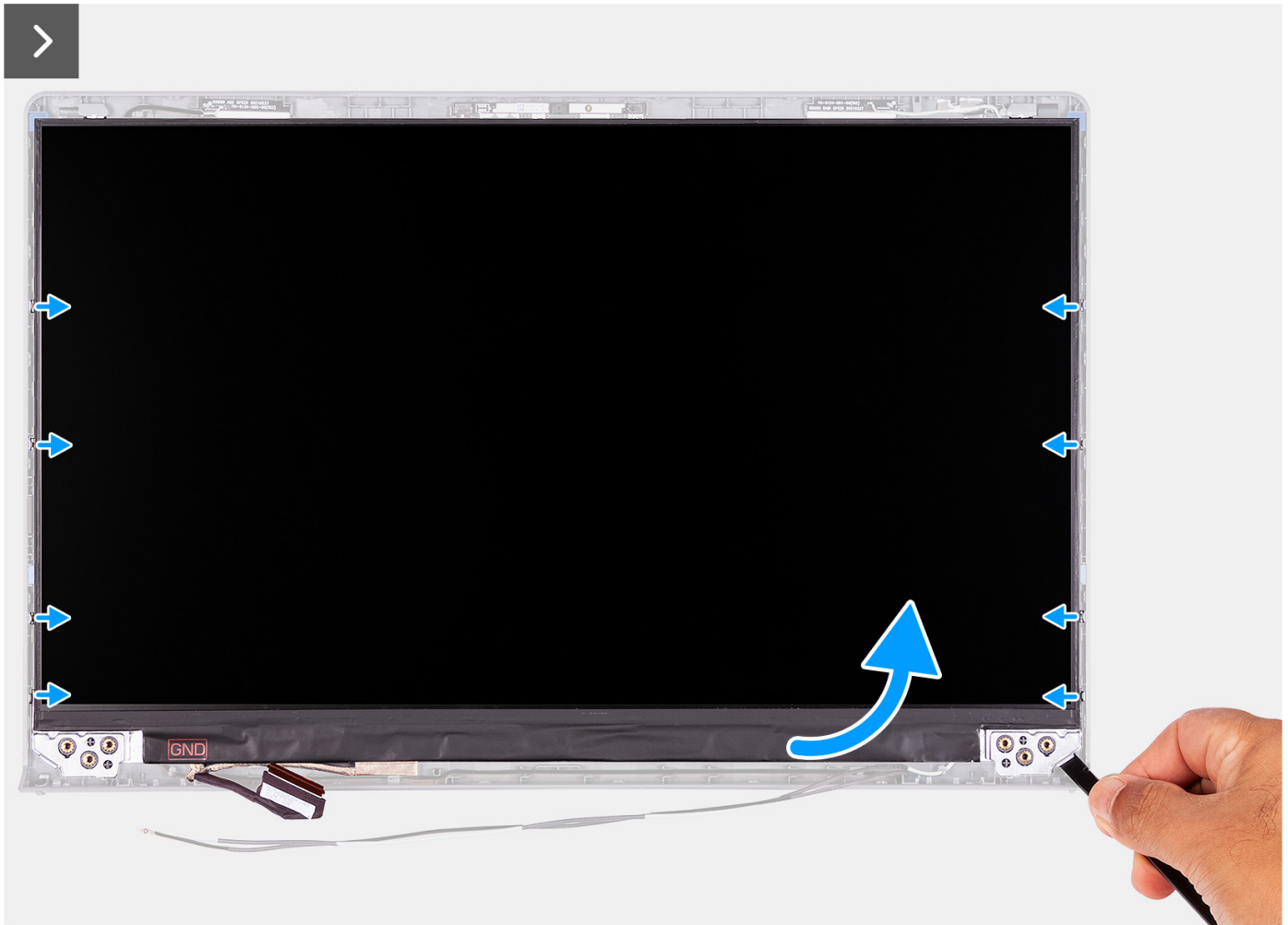





Steps

1. Use a plastic scribe to pry the display panel from the bottom-right corner.



2. Gently start prying the display panel along the right side of the display back-cover using your hand.

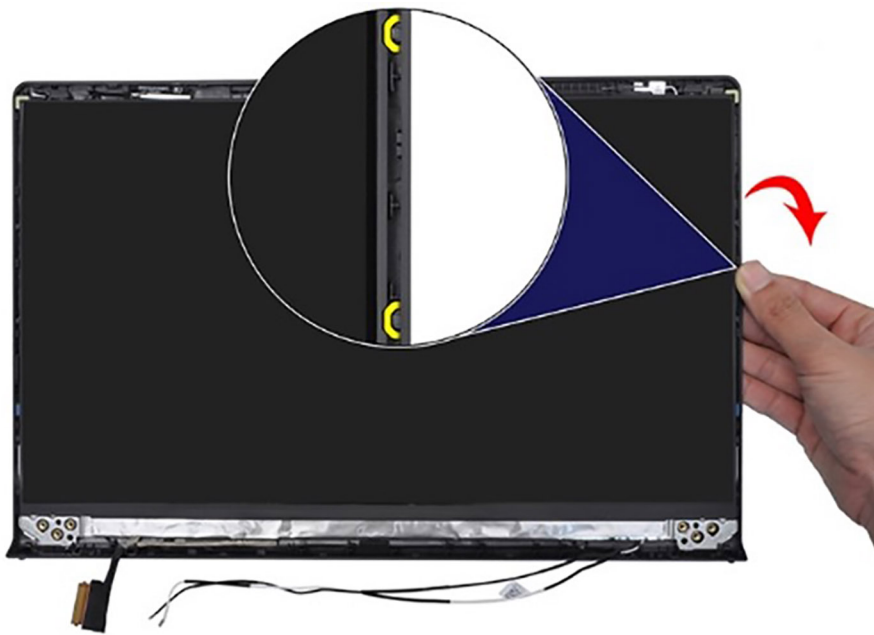

3. Repeat step 1 and 2 for the left side of the display panel assembly.

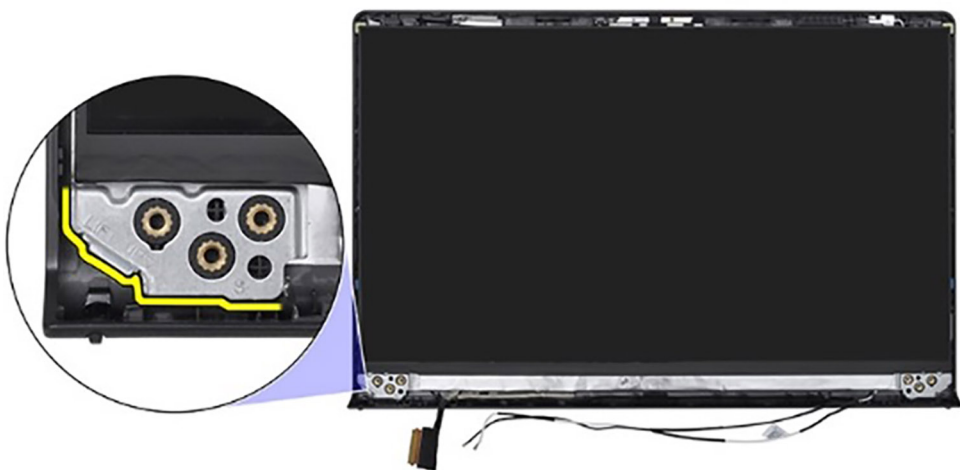

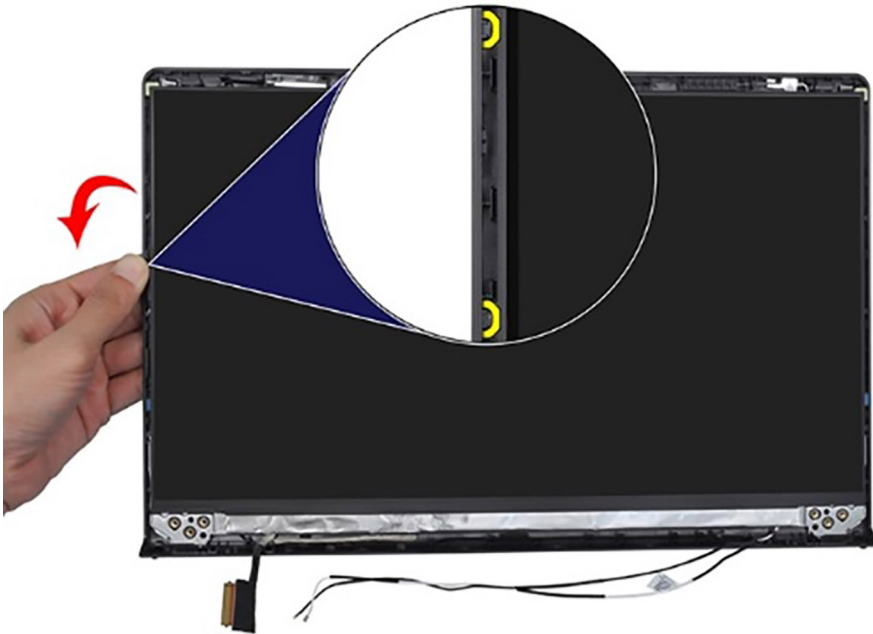

4. Lift the bottom side of the display panel and slide it downward to release the display brackets from the slots at the top side of the display cover.

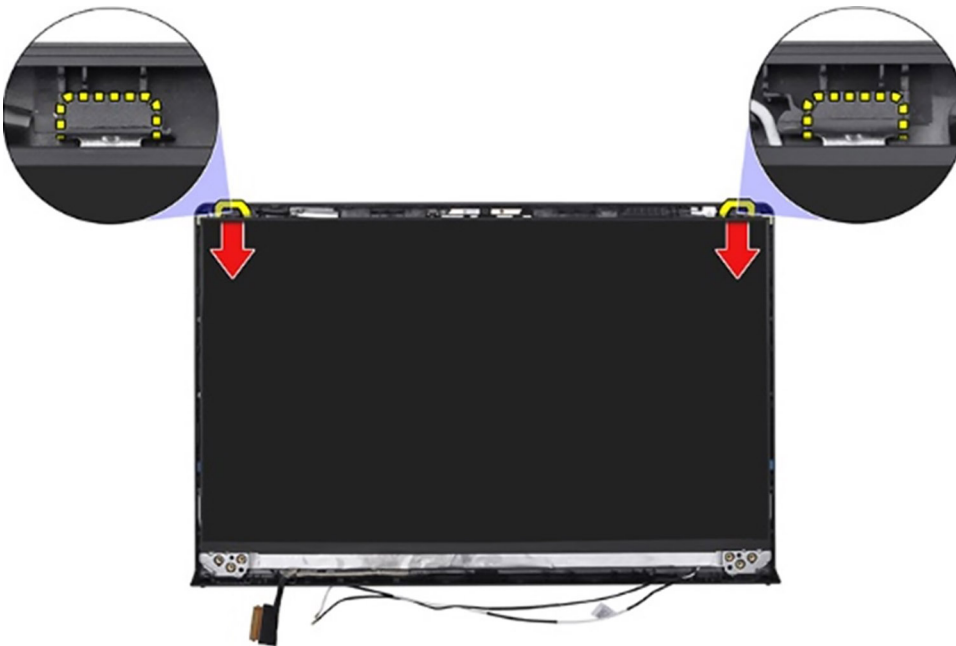

5. Gently flip the display panel assembly forward, peel back the Mylar tape securing the display cable on the rear of the display panel.

i **NOTE:** Ensure that the panel has a clean and smooth surface to rest on to prevent damage.

6. Disconnect the display cable from the display panel assembly and lift the display panel away from the system.

i **NOTE:** For models shipped with plastic chassis, the display panel is assembled with the display brackets as a single service part. DO NOT pull the two pieces of elastic tape and separate the brackets from the panel.



Installing the display panel

CAUTION: The information in this section is intended for authorized service technicians only.

NOTE: This procedure is applicable for systems shipped with a plastic chassis only.

Prerequisites

If you are replacing a component, remove the existing component before performing the installation process.

About this task

The following images indicate the location of the display panel and provide a visual representation of the installation procedure.







Steps

1. Place the display panel and display assembly on a clean and flat surface.
2. Connect the display cable to the connector on the display panel and close the latch.
3. Adhere the tape to secure the display-cable connector latch to the display panel.
4. Lift and rotate the display panel, and then place the display panel on the display assembly.
5. Place the display bezel on the display assembly.
6. Align the tabs on the display bezel to the slots on the display assembly.
7. Press down on the display bezel and snap the display bezel in place.

Next steps

1. Install the [hinges](#).
2. Install the [display bezel](#).
3. Install the [hinge caps](#).
4. Install the [display assembly](#).
5. Install the [wireless card](#).
6. Install the [base cover](#).
7. Install the [SD card](#).
8. Follow the procedure in [After working inside your computer](#).

eDP cable

Removing the eDP cable

 **CAUTION:** The information in this section is intended for authorized service technicians only.

 **NOTE:** This procedure is applicable for systems shipped with a plastic chassis only.

Prerequisites

1. Follow the procedure in [Before working inside your computer](#).
2. Remove the [SD card](#).
3. Remove the [base cover](#).
4. Remove the [wireless card](#).
5. Remove the [display assembly](#).
6. Remove the [hinge caps](#).
7. Remove the [display bezel](#).
8. Remove the [hinges](#).
9. Remove the [display panel](#).

About this task

The following image indicates the location of the eDP cable and provides a visual representation of the removal procedure.

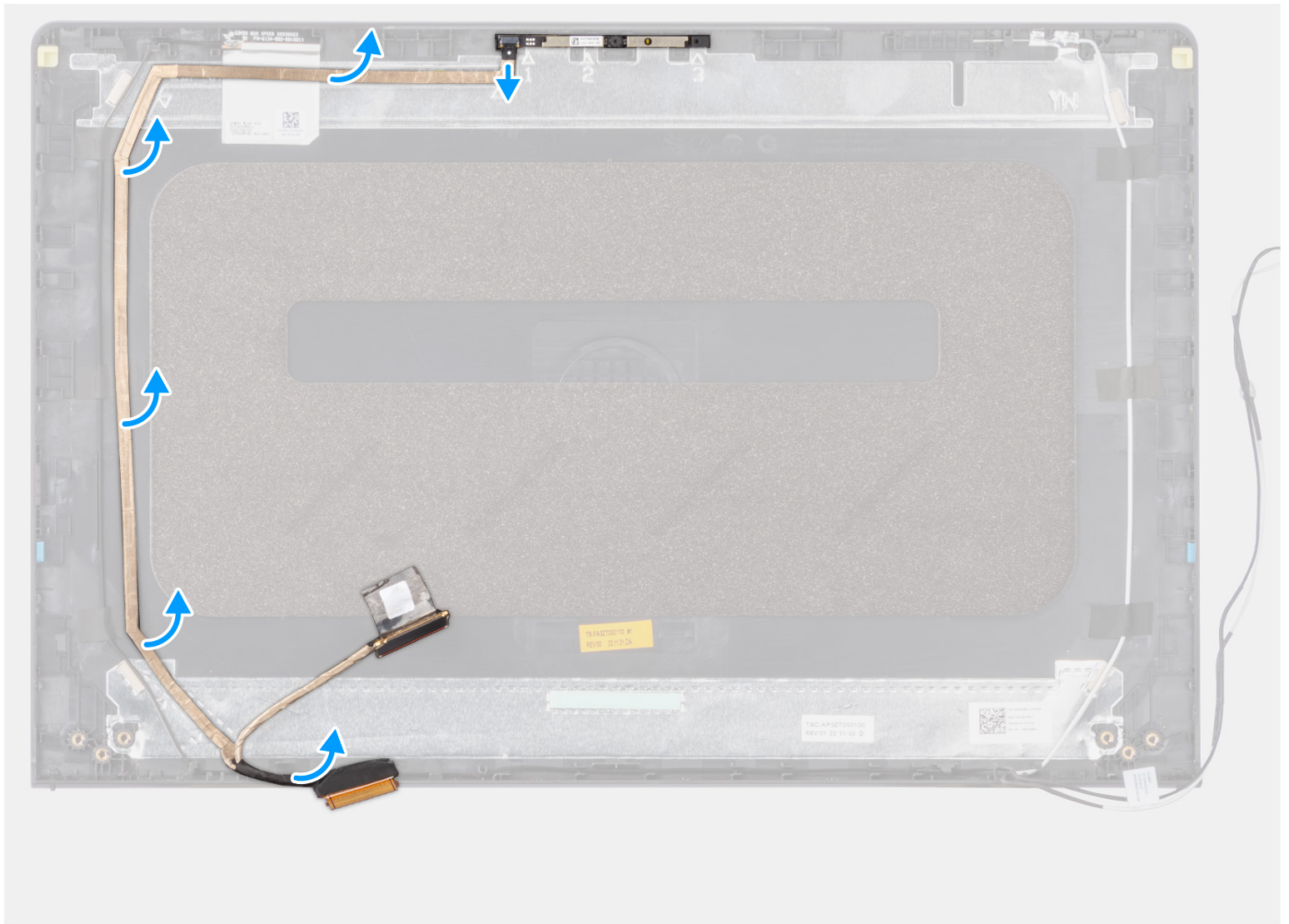
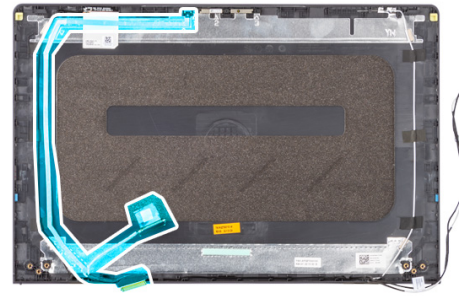

Steps

1. Disconnect the eDP cable from the camera.
2. Peel and remove the eDP cable from the display cover.

Installing the eDP cable

CAUTION: The information in this section is intended for authorized service technicians only.

NOTE: This procedure is applicable for systems shipped with a plastic chassis only.

About this task

The following image indicates the location of the eDP cable and provides a visual representation of the installation procedure.

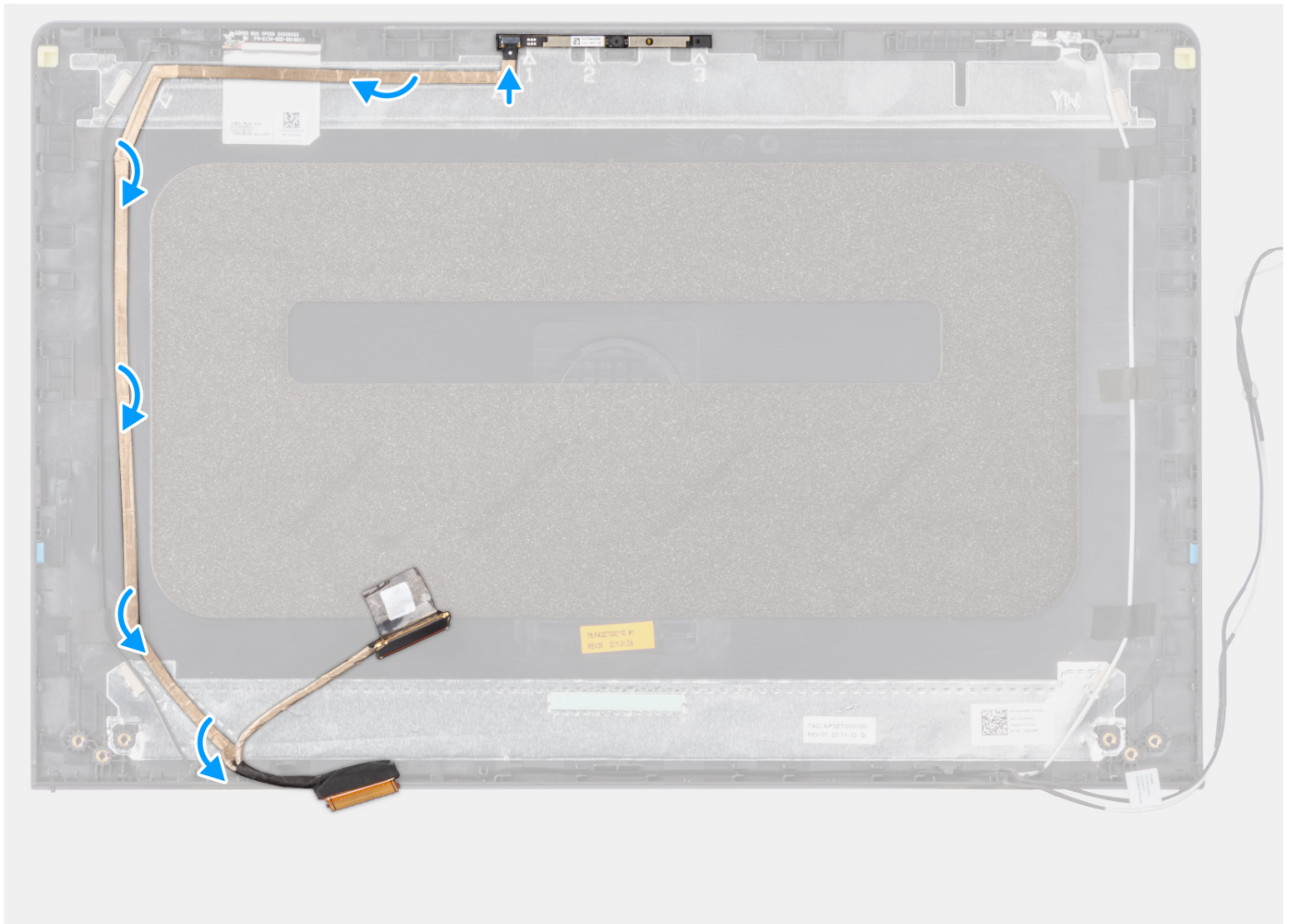
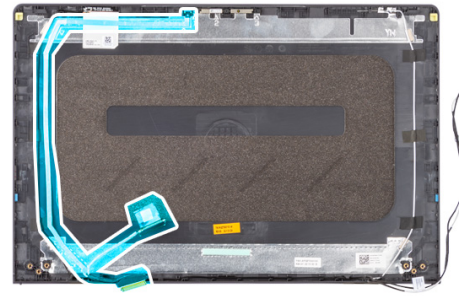

Steps

1. Adhere the tape to securing the eDP cable to the display back cover.
2. Connect the eDP cable to the camera.

Next steps

1. Install the [display panel](#).
2. Install the [hinges](#).
3. Install the [display bezel](#).
4. Install the [hinge caps](#).
5. Install the [display assembly](#).
6. Install the [wireless card](#).
7. Install the [base cover](#).
8. Install the [SD card](#).

9. Follow the procedure in [After working inside your computer](#).

Camera assembly

Removing the camera module

CAUTION: The information in this section is intended for authorized service technicians only.

NOTE: This procedure is applicable for systems shipped with a plastic chassis only.

Prerequisites

1. Follow the procedure in [Before working inside your computer](#).
2. Remove the [SD card](#).
3. Remove the [base cover](#).
4. Remove the [wireless card](#).
5. Remove the [display assembly](#).
6. Remove the [hinge caps](#).
7. Remove the [display bezel](#).
8. Remove the [hinges](#).
9. Remove the [display panel](#).

About this task

The following images indicate the location of the camera module and provide a visual representation of the removal procedure.

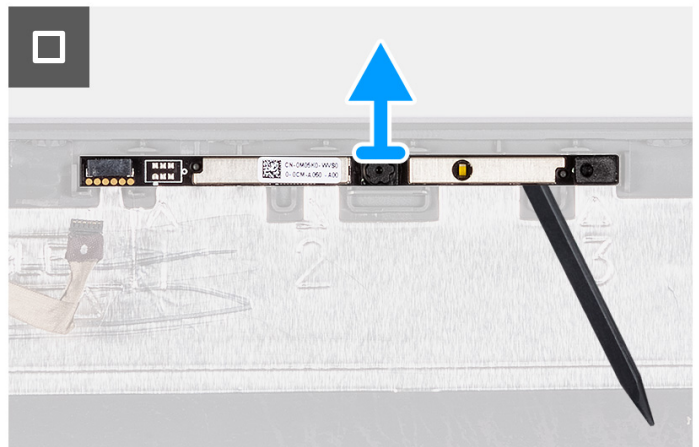
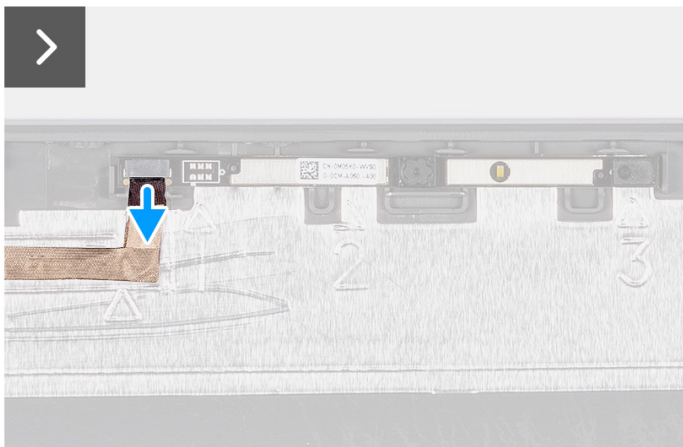
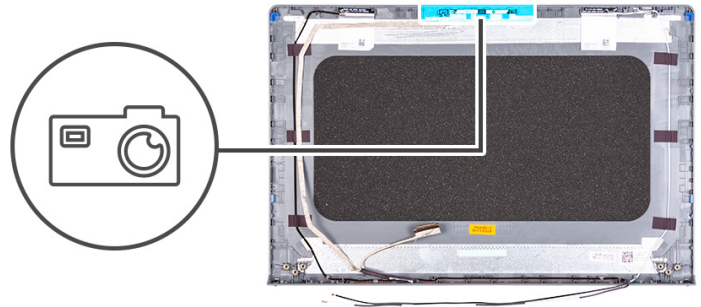

Steps

1. Using the pull tab, disconnect the camera cable from the camera module.
2. Using a plastic scribe, pry the camera module from the display assembly.

NOTE: Start prying the camera module in a sequential order 1>2>3 as indicated on the display back cover.

3. Lift the camera module from the display assembly.

Installing the camera module

CAUTION: The information in this section is intended for authorized service technicians only.

NOTE: This procedure is applicable for systems shipped with a plastic chassis only.

Prerequisites

If you are replacing a component, remove the existing component before performing the installation process.

About this task

The following images indicate the location of the camera module and provide a visual representation of the installation procedure.

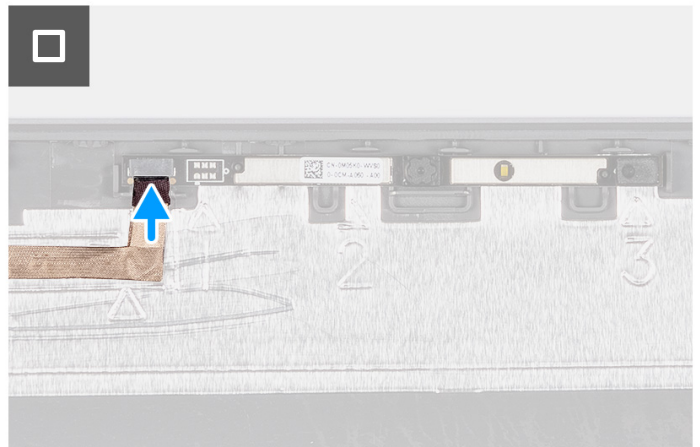
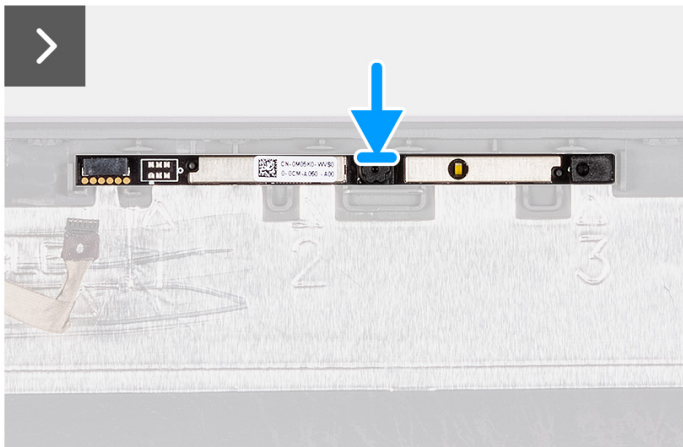
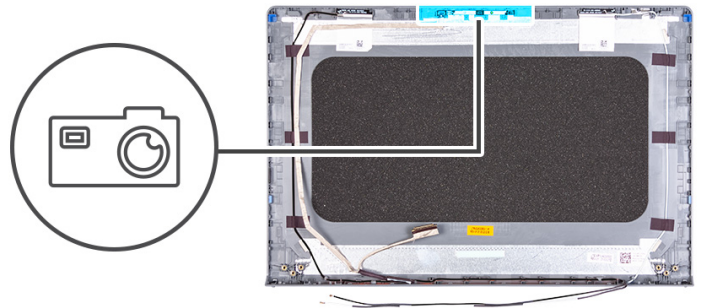

Steps

1. Adhere the camera module in its slot on the display assembly.
2. Connect the camera cable to the camera module.

Next steps

1. Install the [display panel](#).
2. Install the [hinges](#).
3. Install the [display bezel](#).
4. Install the [hinge caps](#).
5. Install the [display assembly](#).
6. Install the [wireless card](#).

7. Install the [base cover](#).
8. Install the [SD card](#).
9. Follow the procedure in [After working inside your computer](#).

Display cover and antenna assembly

Replacement of the display cover and antenna assembly

 **CAUTION:** The information in this section is intended for authorized service technicians only.

 **NOTE:** This procedure is applicable for systems shipped with a plastic chassis only.

Prerequisites

1. Follow the procedure in [Before working inside your computer](#).
2. Remove the [SD card](#).
3. Remove the [base cover](#).
4. Remove the [wireless card](#).
5. Remove the [display assembly](#).
6. Remove the [hinge caps](#).
7. Remove the [display bezel](#).
8. Remove the [hinges](#).
9. Remove the [display panel](#).
10. Remove the [camera module](#).
11. Remove the [eDP cable](#).

 **NOTE:** The display cover and antenna assembly cannot be further disassembled. If the WLAN antennas are malfunctioning and needs replacement, replace the entire display cover and antenna assembly.

About this task

The following image indicates the location of the display cover and antenna assembly and provides a visual representation of the removal procedure.



Steps

After performing the pre-requisites, you are left with the display cover and antenna assembly.

Power-adapter port

Removing the power-adapter port

CAUTION: The information in this section is intended for authorized service technicians only.

Prerequisites

1. Follow the procedure in [Before working inside your computer](#).
2. Remove the [SD card](#).
3. Remove the [base cover](#).
4. Remove the [display assembly](#).

About this task

The following images indicate the location of the power-adapter port and provide a visual representation of the removal procedure.



2x
M2.5x5

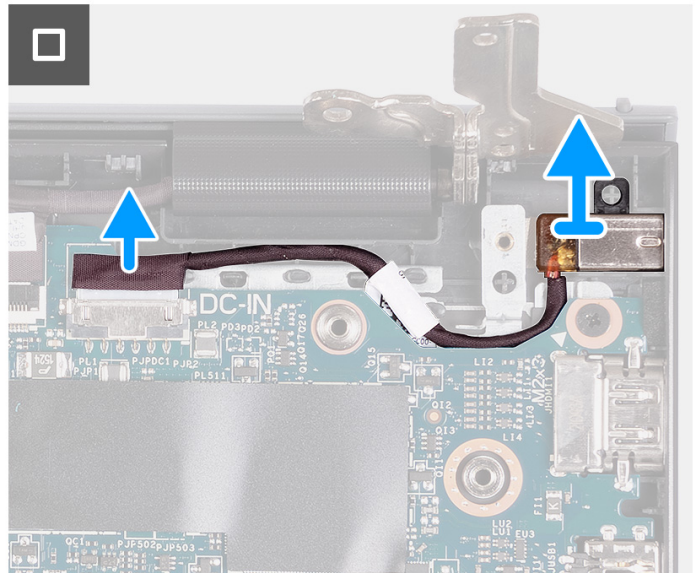
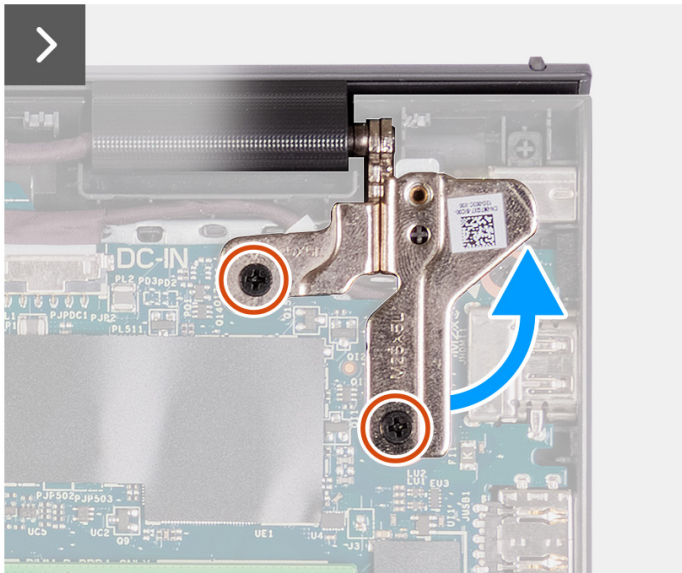
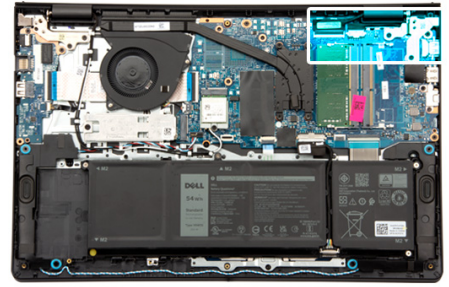

Steps

1. Remove the two (M2.5x5) screws that secure the right hinge to the palm-rest and keyboard assembly.
2. Disconnect the power-adapter cable from the connector on the system board.
3. Lift the power-adapter port from its slot on the palm-rest and keyboard assembly.

Installing the power-adapter port

CAUTION: The information in this section is intended for authorized service technicians only.

Prerequisites

If you are replacing a component, remove the existing component before performing the installation process.

About this task

The following images indicate the location of the power-adapter port and provide a visual representation of the installation procedure.



2x
M2.5x5

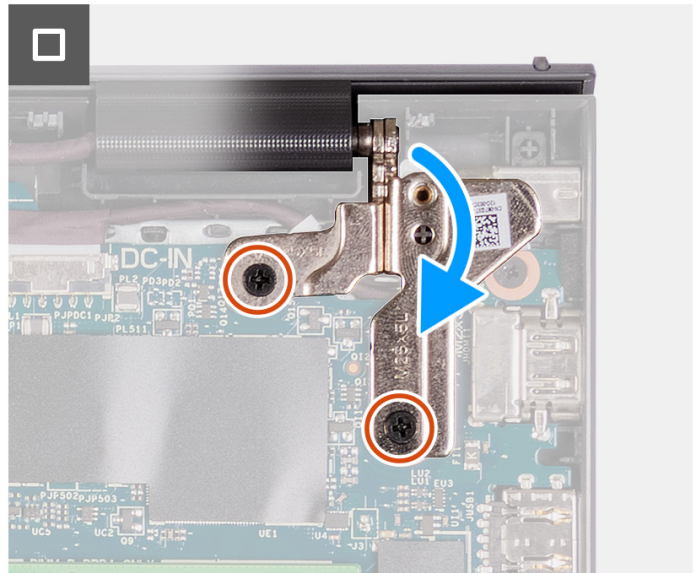
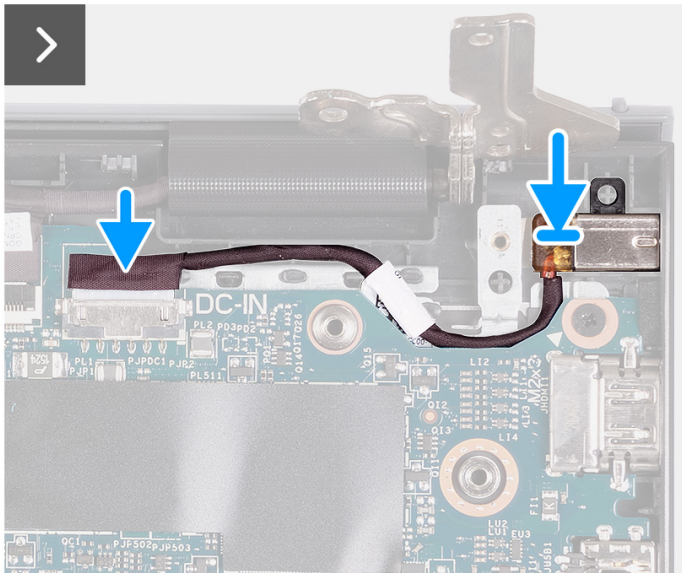
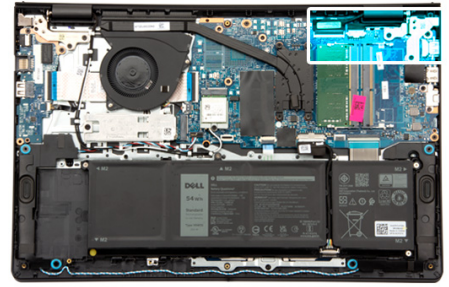

Steps

1. Using the alignment post, place the power-adaptor port into its slot on the palm-rest and keyboard assembly.
2. Connect the power-adaptor port cable to the connector on the system board.
3. Fold the right hinge down and install the two (M2.5x5) screws to secure it to the palm-rest and keyboard assembly.

Next steps

1. Install the [base cover](#).
2. Install the [SD card](#).
3. Follow the procedure in [After working inside your computer](#).

Power-button board

Removing the power button

⚠ CAUTION: The information in this section is intended for authorized service technicians only.

Prerequisites

1. Follow the procedure in [Before working inside your computer](#).
2. Remove the [SD card](#).
3. Remove the [base cover](#).
4. Remove the [wireless card](#).
5. Remove the [I/O board](#).
6. Remove the [display assembly](#).

About this task

The following images indicate the location of the power button and provide a visual representation of the removal procedure.



1x
M2x2

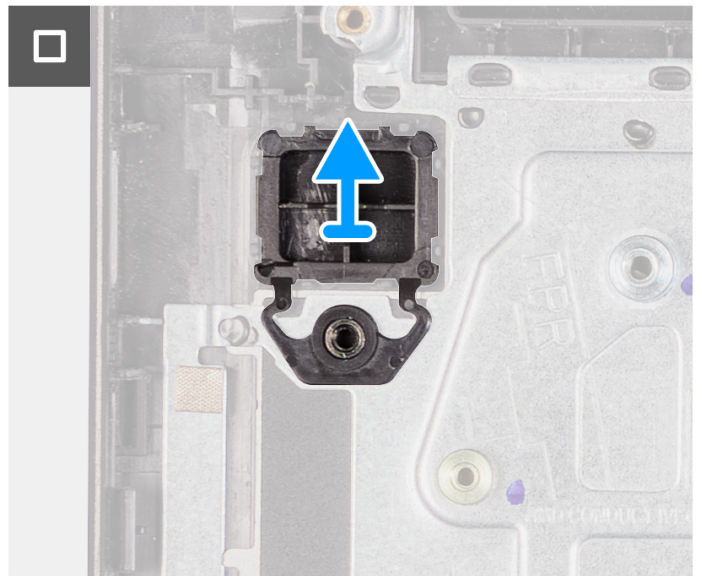
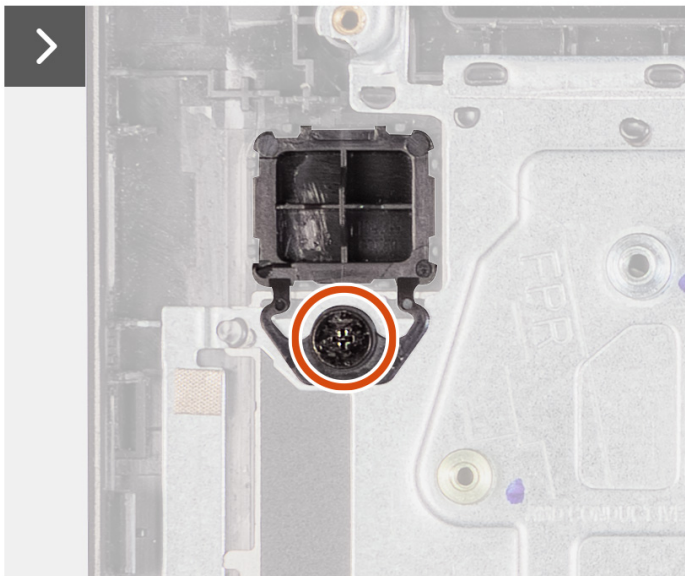
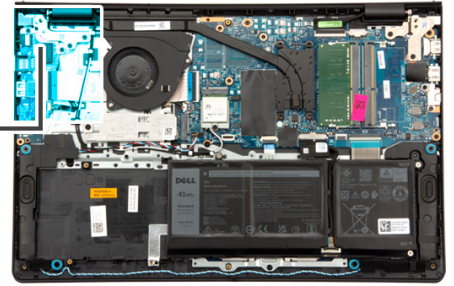

Steps

1. Remove the single (M2x2) screw securing the power button to the palm-rest and keyboard assembly.
2. Remove the power button from the computer.

Installing the power button

CAUTION: The information in this section is intended for authorized service technicians only.

Prerequisites

If you are replacing a component, remove the existing component before performing the installation procedure.

About this task

The following images indicate the location of the power button and provide a visual representation of the installation procedure.



1x
M2x2

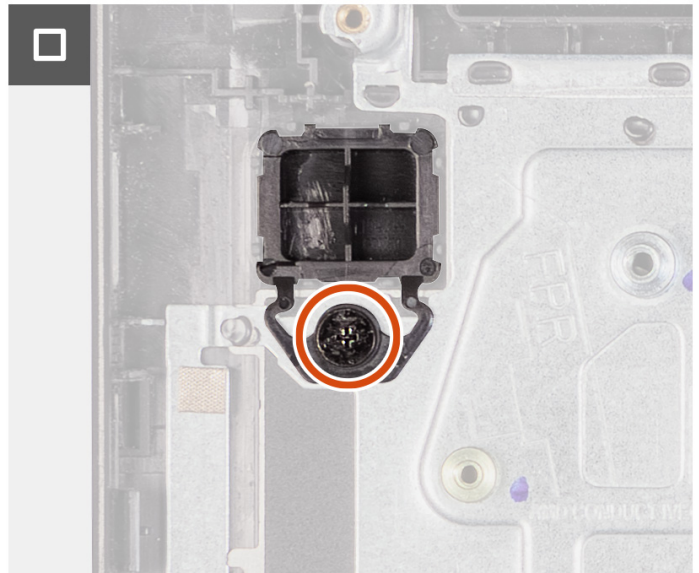
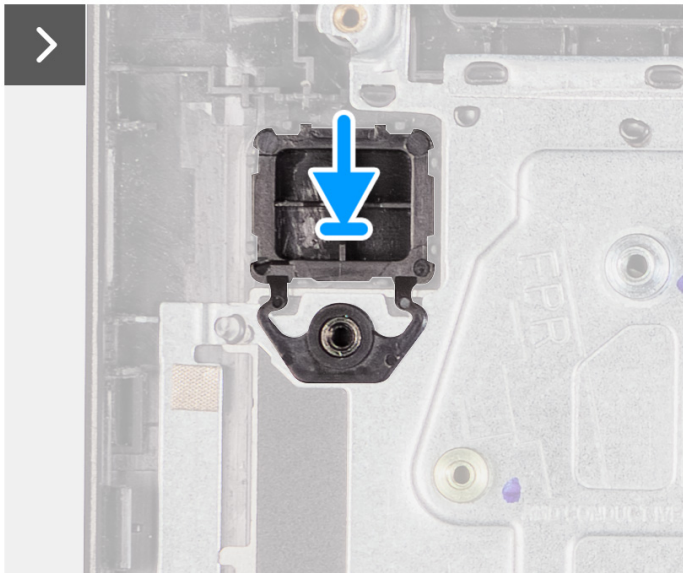
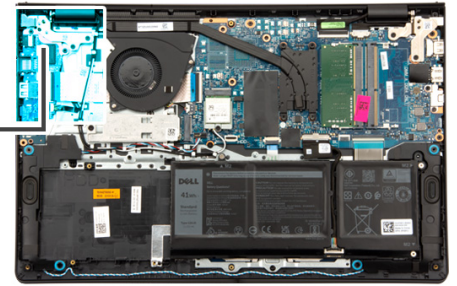
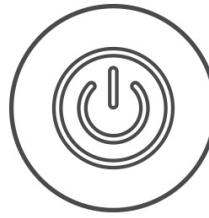

Steps

1. Place the power-button board into the slot on the palm-rest and keyboard assembly.
2. Install the single (M2x2) screw to secure the power button to the palm-rest and keyboard assembly.

Next steps

1. Install the [display assembly](#).
2. Install the [wireless card](#).
3. Install the [I/O board](#).
4. Install the [base cover](#).
5. Install the [SD card](#).
6. Follow the procedure in [After working inside your computer](#).

Power button with optional fingerprint reader

Removing the power button with optional fingerprint reader

 **CAUTION:** The information in this section is intended for authorized service technicians only.

Prerequisites

1. Follow the procedure in [Before working inside your computer](#).
2. Remove the [SD card](#).
3. Remove the [base cover](#).
4. Remove the [wireless card](#).

5. Remove the [I/O board](#).
6. Remove the [display assembly](#).

About this task

The following images indicate the location of the power button with optional fingerprint reader and provide a visual representation of the removal procedure.



1x
M2x2

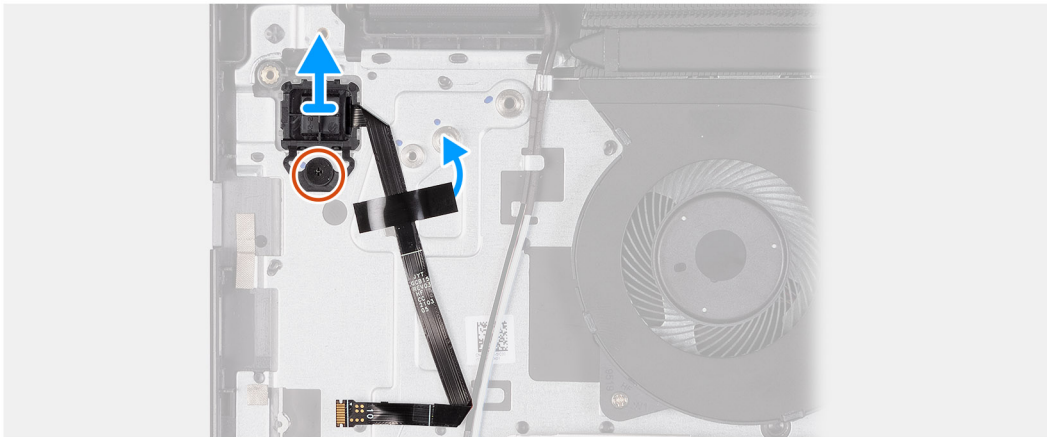
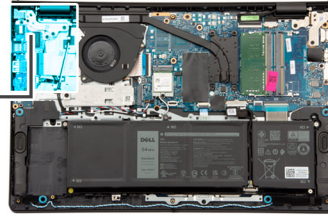

Steps

1. Remove the (M2x2) screw that secures the power button to the palm-rest and keyboard assembly.
2. Peel the tape securing the fingerprint reader Flexible Flat cable to the palm-rest and keyboard assembly.
3. Lift the power button with fingerprint reader, along with its cable, off the palm-rest and keyboard assembly.

Installing the power button with optional fingerprint reader

CAUTION: The information in this section is intended for authorized service technicians only.

Prerequisites

If you are replacing a component, remove the existing component before performing the installation process.

About this task

The following images indicate the location of the power button with optional fingerprint reader and provide a visual representation of the installation procedure.



1x
M2x2

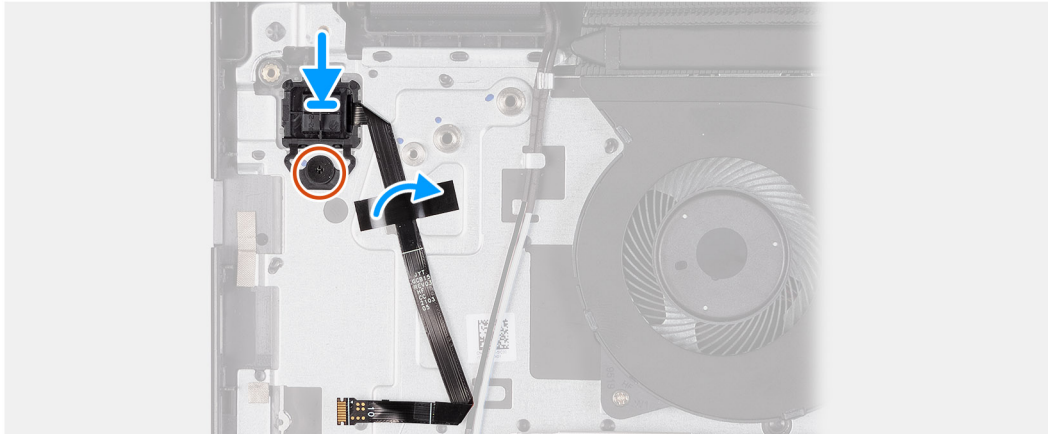
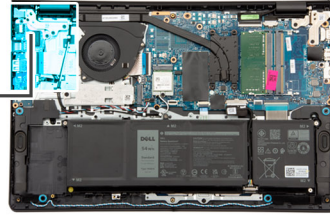

Steps

1. Using the alignment posts, place the power button with fingerprint reader into its slot on the palm-rest and keyboard assembly.
2. Replace the (M2x2) screw that secures the power button with fingerprint reader to the palm-rest and keyboard assembly.
3. Adhere the tape to secure fingerprint reader Flexible Flat cable to the palm-rest and keyboard assembly.

NOTE: Fold and align the fingerprint reader Flexible Flat cable to the mark at the right of the power button, and align the white line on the Flexible Flat cable to the mark on the palm-rest and keyboard assembly.

Next steps

1. Install the [display assembly](#).
2. Install the [I/O board](#).
3. Install the [wireless card](#).
4. Install the [base cover](#).
5. Install the [SD card](#).
6. Follow the procedure in [After working inside your computer](#).

System board

Removing the system board

CAUTION: The information in this section is intended for authorized service technicians only.

Prerequisites

1. Follow the procedure in [Before working inside your computer](#).
2. Remove the [SD card](#).
3. Remove the [base cover](#).
4. Remove the [3-cell battery](#) or [4-cell battery](#) (whichever applicable).
5. Remove the [M.2 2230 solid-state drive](#) or [M.2 2280 solid-state drive](#) (whichever applicable).
6. Remove the [memory modules](#).

7. Remove the [wireless card](#).
8. Remove the [fan](#).
9. Remove the [UMA heat sink](#) or [discrete heat sink](#) (whichever applicable).
10. Remove the [display assembly](#).

About this task

The following image indicates the connectors on your system board.

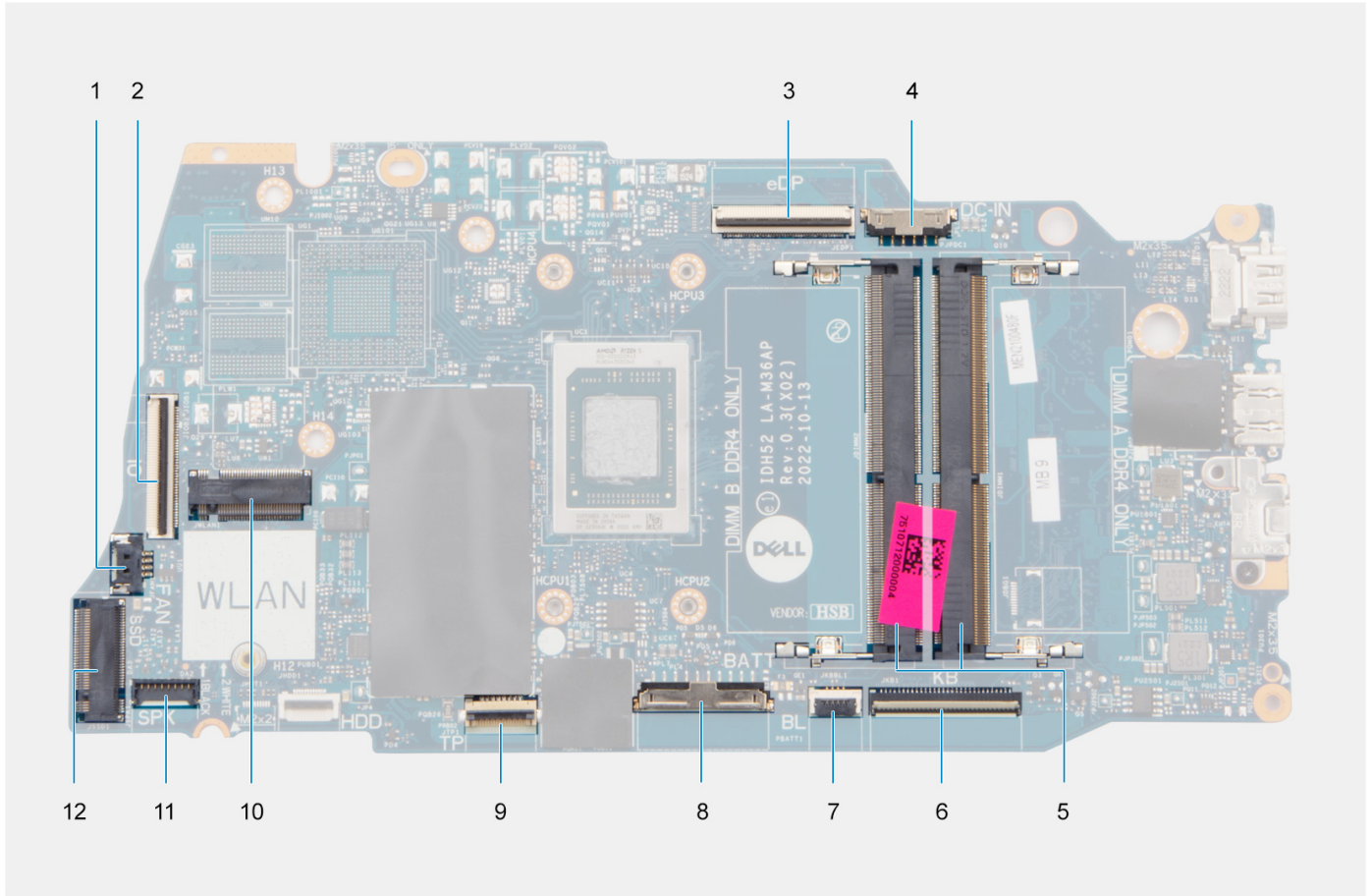

- | | |
|-------------------------------------|---------------------------------|
| 1. Fan connector | 2. I/O board FFC connector |
| 3. eDP connector | 4. DC-in port connector |
| 5. Memory modules | 6. Keyboard FFC connector |
| 7. Keyboard-backlight FFC connector | 8. Battery connector |
| 9. Touchpad FFC connector | 10. Wireless connector |
| 11. Speaker cable connector | 12. Solid-state drive connector |

The following images indicate the location of the system board and provide a visual representation of the removal procedure.

Steps

1. Remove the two (M2.5x5) screws from the right hinge.
2. Pry open the right-display hinge at an angle of 90 degrees.
3. Disconnect the following cables from the system board:
 - a. I/O board Flexible Flat cable
 - b. Speaker cable
 - c. Touchpad Flexible Flat cable
 - d. Keyboard backlight Flexible Printed cable (for systems with backlit keyboard)
 - e. Keyboard Flexible Printed cable
 - f. Power adapter port cable
 - g. eDP cable
4. Remove the four (M2x3.5) screws that secure the system board to the palm-rest assembly.
5. Remove the single (M2x2) screw that secures the system board to the palm-rest assembly.
6.  **NOTE:** For systems shipped with a USB Type-C port, do not remove the type-C bracket that is secured to the system board.

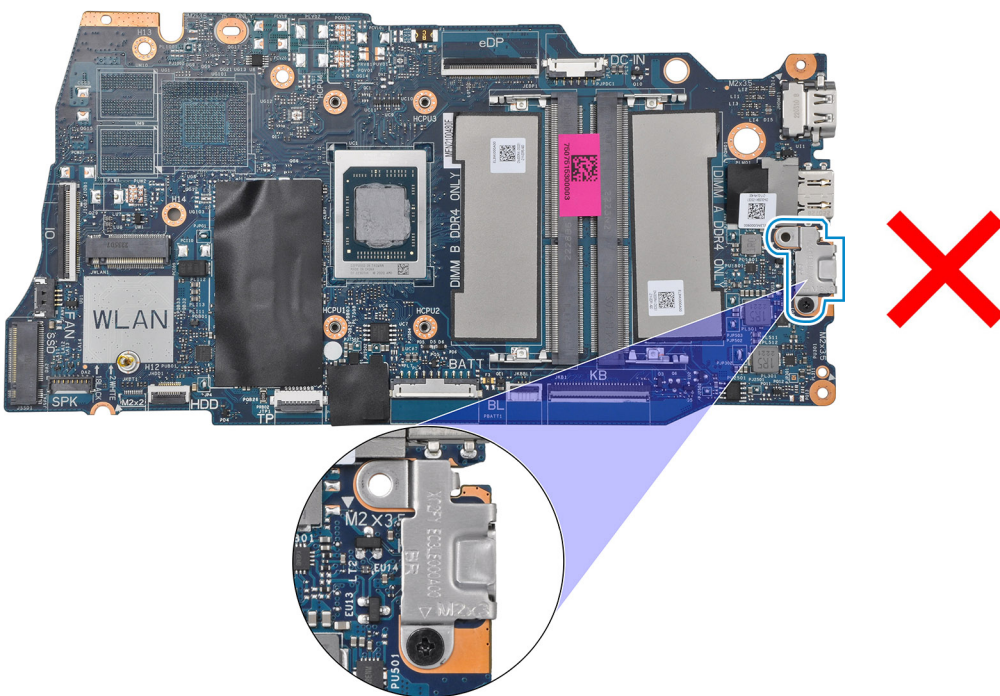

7. Carefully lift the system board away from the chassis.

Installing the system board

 **CAUTION:** The information in this section is intended for authorized service technicians only.

Prerequisites

If you are replacing a component, remove the existing component before performing the installation process.

About this task

The following image indicates the connectors on your system board.

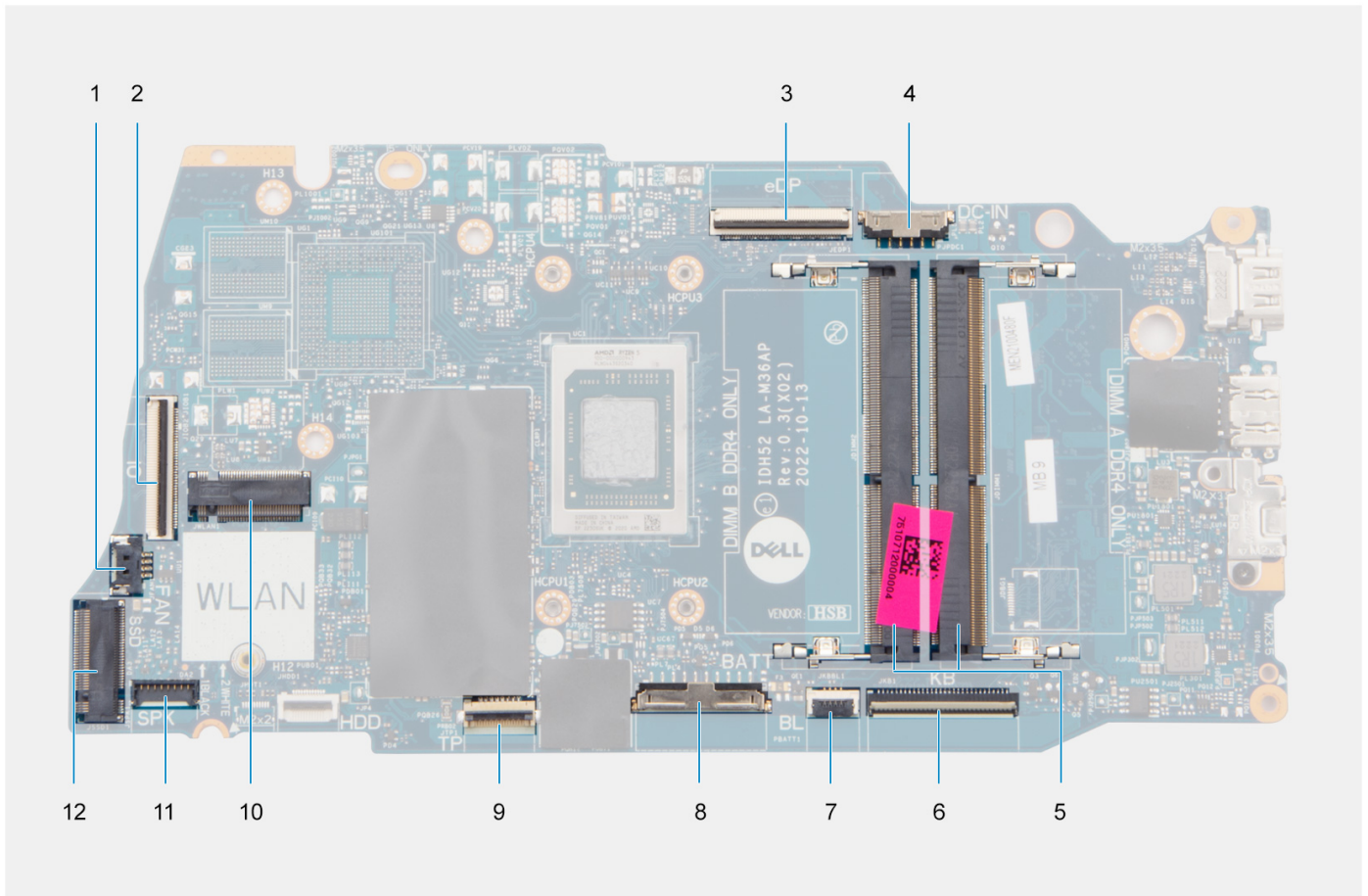

- | | |
|-------------------------------------|---------------------------------|
| 1. Fan connector | 2. I/O board FFC connector |
| 3. eDP connector | 4. DC-in port connector |
| 5. Memory modules | 6. Keyboard FFC connector |
| 7. Keyboard-backlight FFC connector | 8. Battery connector |
| 9. Touchpad FFC connector | 10. Wireless connector |
| 11. Speaker cable connector | 12. Solid-state drive connector |

The following images indicate the location of the system board and provide a visual representation of the installation procedure.

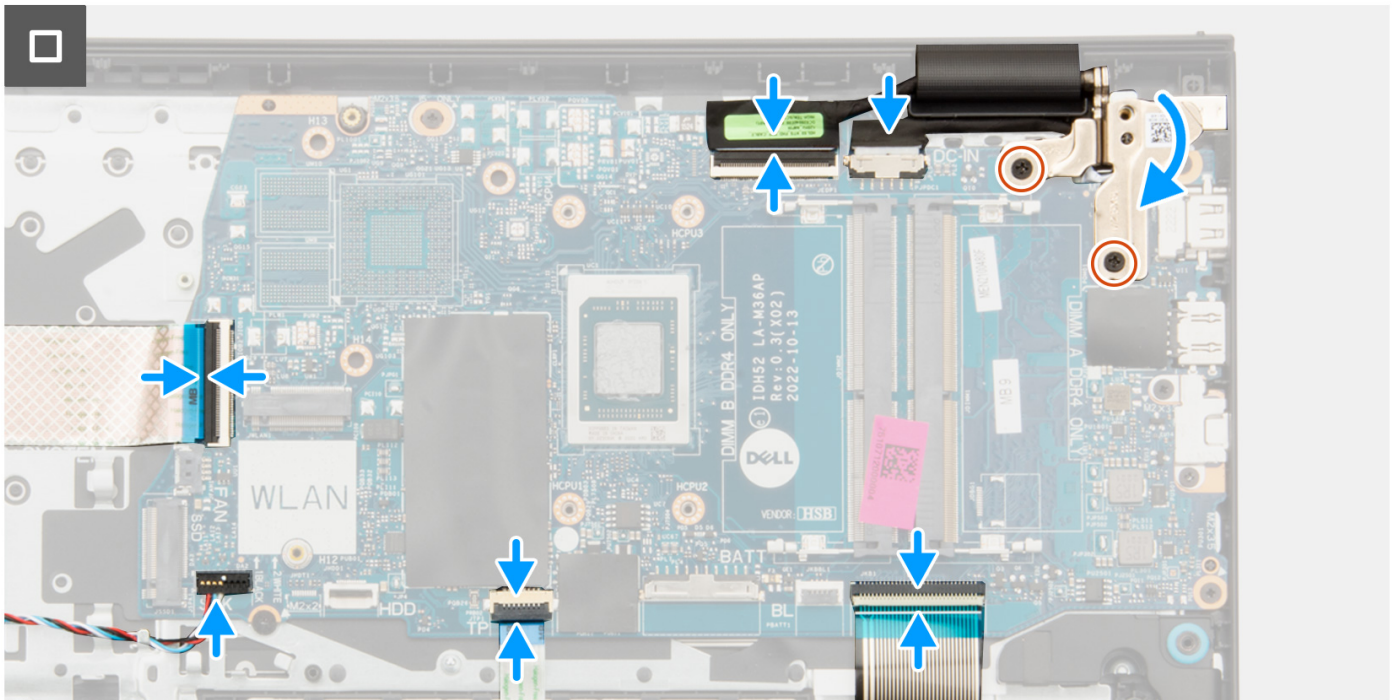
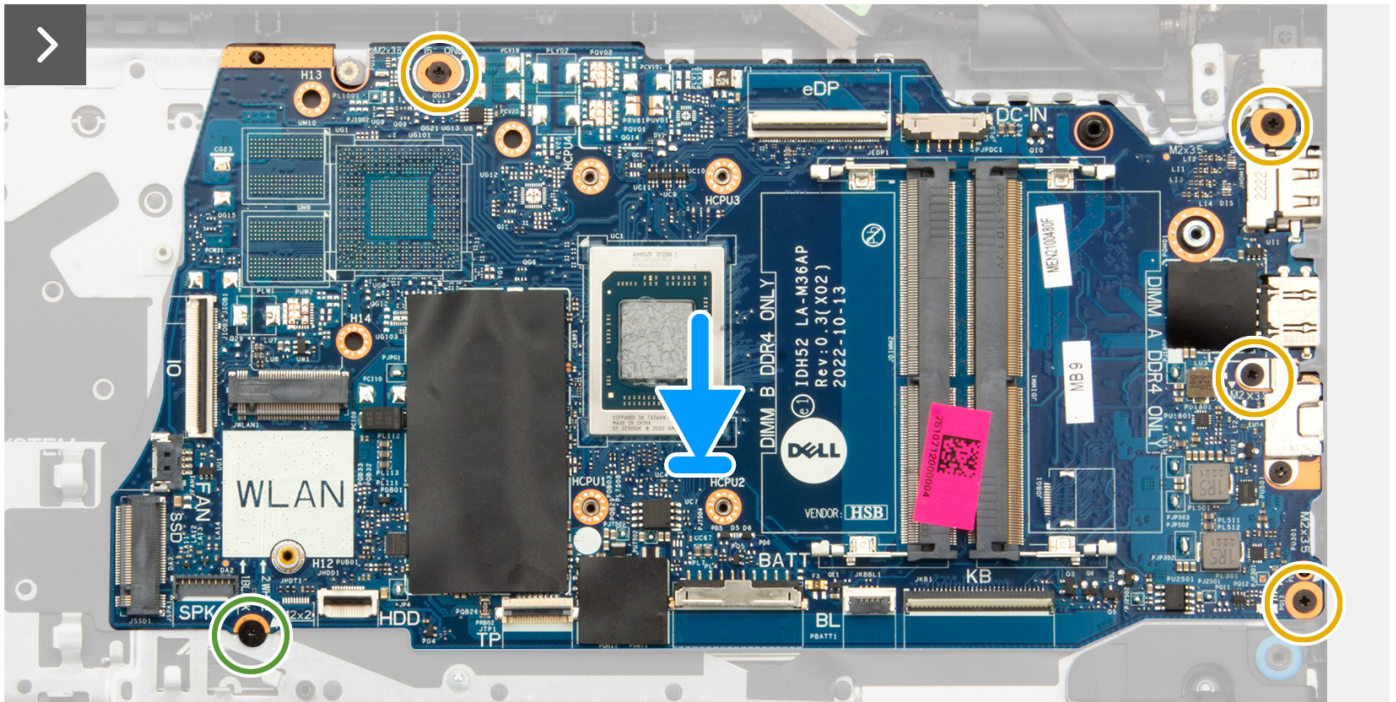
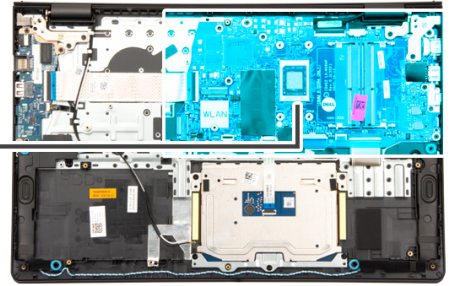
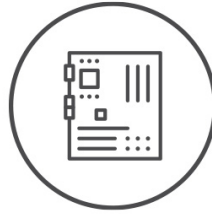

Steps

1. Place the system board on the palm-rest and keyboard assembly.
2. Align the screw holes on the system board with the screw holes on the palm-rest assembly.
3. Replace the single (M2x2) screw that secures the system board to the palm-rest assembly.
4. Replace the four (M2x3.5) screws that secure the system board to the palm-rest assembly.
5. Connect the following cables to the system board:
 - a. I/O board Flexible Flat cable
 - b. Speaker cable
 - c. Touchpad Flexible Flat cable
 - d. Keyboard backlight Flexible Printed cable (for systems with backlit keyboard)
 - e. Keyboard Flexible Printed cable
 - f. Power adapter port cable
 - g. eDP cable
6. Close the right-display hinge and align the screw holes on the right-display hinge with the screw holes on the system board.
7. Replace the two (M2.5x5) screws to secure it to the palm-rest assembly.

Next steps

1. Install the [display assembly](#).
2. Install the [UMA heat sink](#) or [discrete heat sink](#), whichever applicable.
3. Install the [fan](#).
4. Install the [wireless card](#).
5. Install the [memory modules](#).
6. Install the [M.2 2230 solid-state drive](#) or [M.2 2280 solid-state drive](#) (whichever applicable).
7. Install the [3-cell battery](#) or [4-cell battery](#) (whichever applicable).
8. Install the [base cover](#).
9. Install the [SD card](#).
10. Follow the procedure in [After working inside your computer](#).

Palm-rest and keyboard assembly

Removing the palm-rest and keyboard assembly

 **CAUTION:** The information in this section is intended for authorized service technicians only.

Prerequisites

1. Follow the procedure in [Before working inside your computer](#).
2. Remove the [SD card](#).
3. Remove the [base cover](#).
4. Remove the [3-cell battery](#) or [4-cell battery](#) (whichever applicable).
5. Remove the [M.2 2230 solid-state drive](#) or [M.2 2280 solid-state drive](#) (whichever applicable).
6. Remove the [memory modules](#).
7. Remove the [wireless card](#).
8. Remove the [speakers](#).
9. Remove the [fan](#).
10. Remove the [UMA heat sink](#) or [discrete heat sink](#) (whichever applicable).
11. Remove the [I/O board](#).
12. Remove the [touchpad](#).
13. Remove the [display assembly](#).
14. Remove the [power-adapter port](#).
15. Remove the [power button](#).
16. Remove the [system board](#).

 **NOTE:** The system board can be removed along with the heat sink.

About this task

The following image indicates the location of the palm-rest and keyboard assembly and provides a visual representation of the removal procedure.

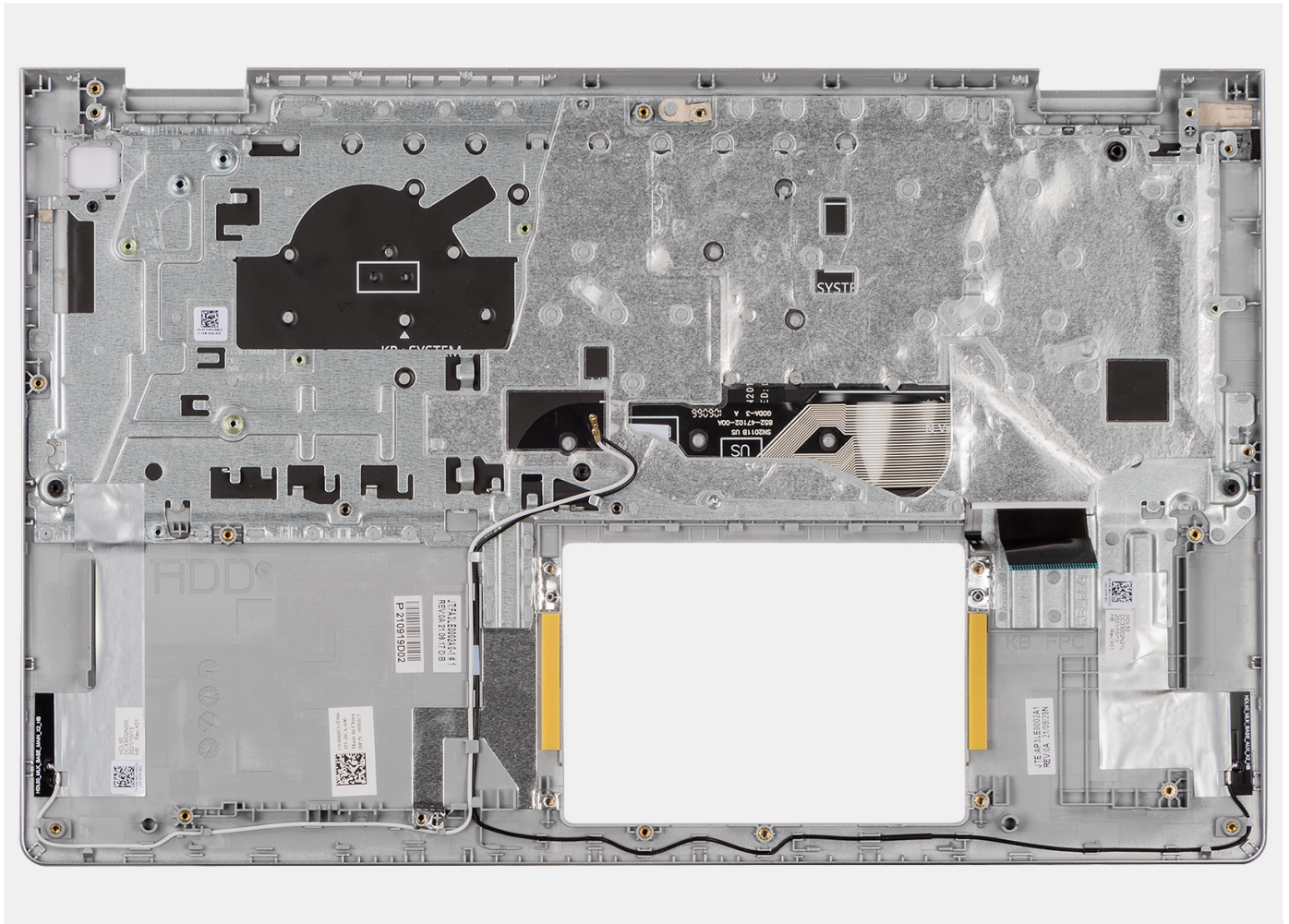

Steps

After performing the pre-requisites, you are left with the palm-rest and keyboard assembly.

i **NOTE:** For systems with aluminum chassis, both the left and right RF metal brackets **MUST** be transferred to the replacement palm-rest.

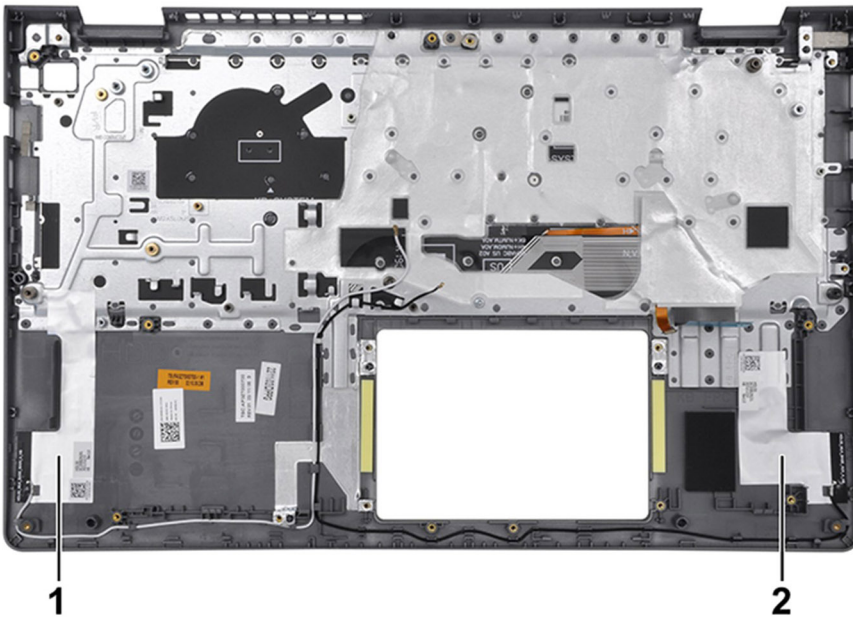

	Components
1	WLAN Antenna (Main)
2	WLAN Antenna (Auxiliary)

Installing the palmrest and keyboard assembly

CAUTION: The information in this section is intended for authorized service technicians only.

Prerequisites

If you are replacing a component, remove the existing component before performing the installation process.

About this task

The following image indicates the location of the palmrest and keyboard assembly and provides a visual representation of the installation procedure.

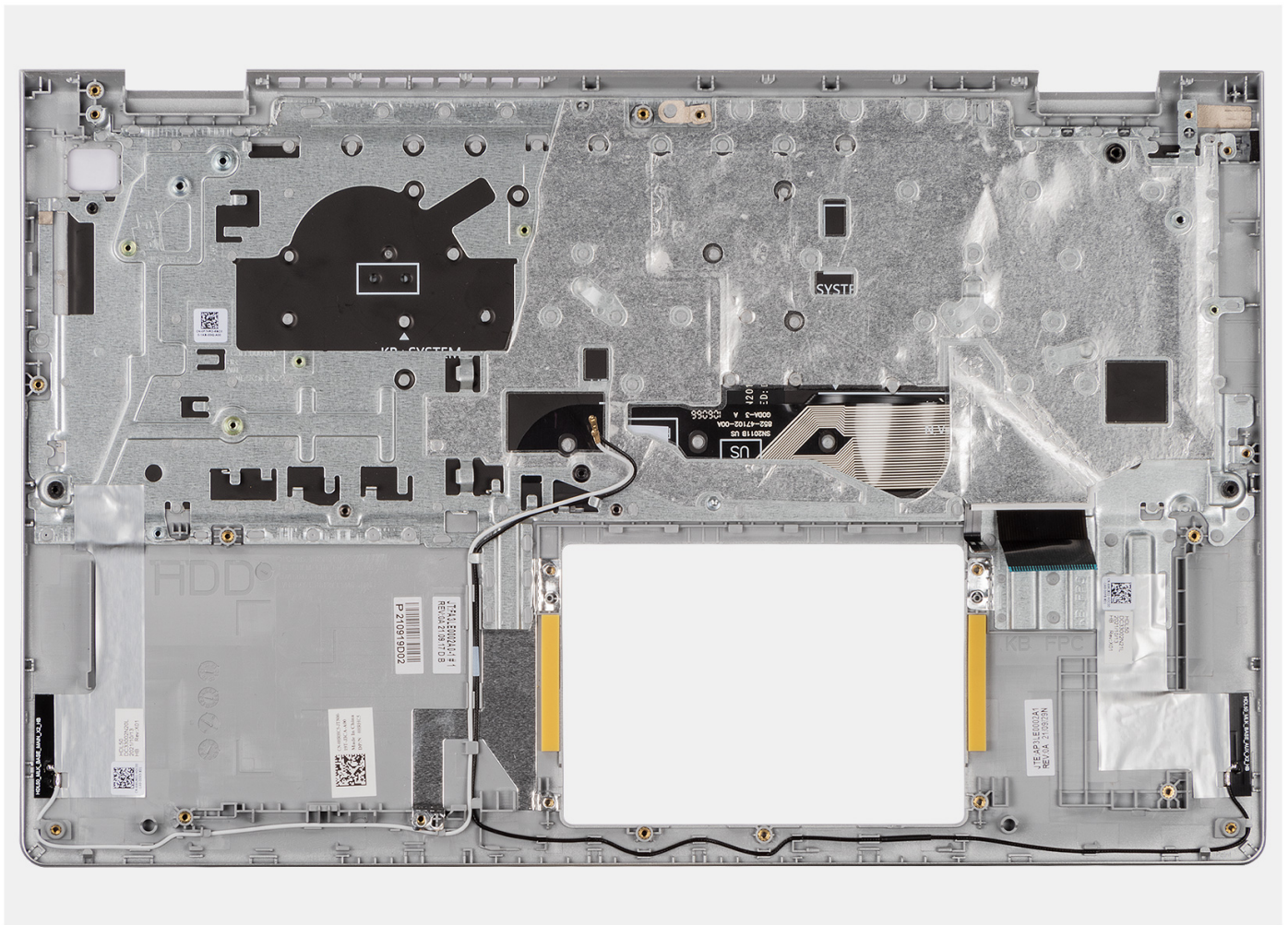

Steps

Place the palm-rest and keyboard assembly on a flat and clean surface and perform the post-requisites to install the palm-rest and keyboard assembly.

i **NOTE:** For systems with aluminum chassis, both the left and right RF metal brackets **MUST** be transferred to the replacement palm-rest assembly.

For systems with a 3-cell battery:

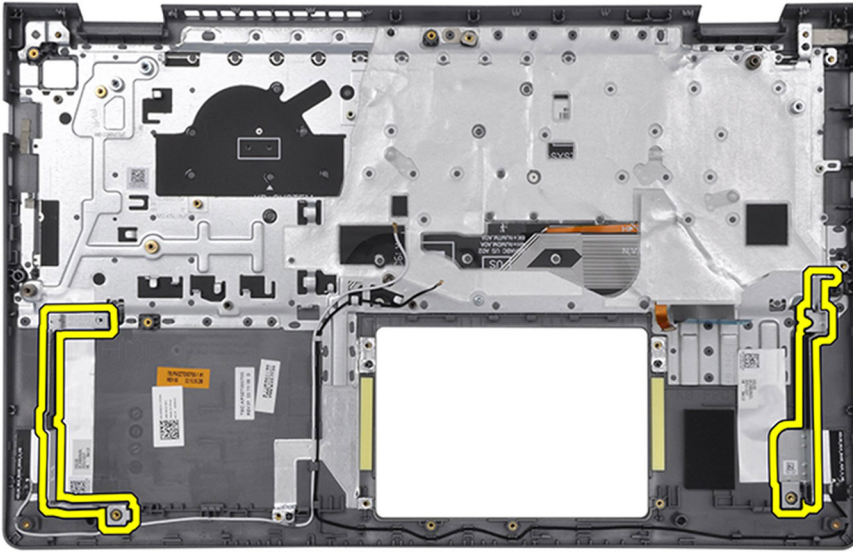

For systems with a 4-cell battery:

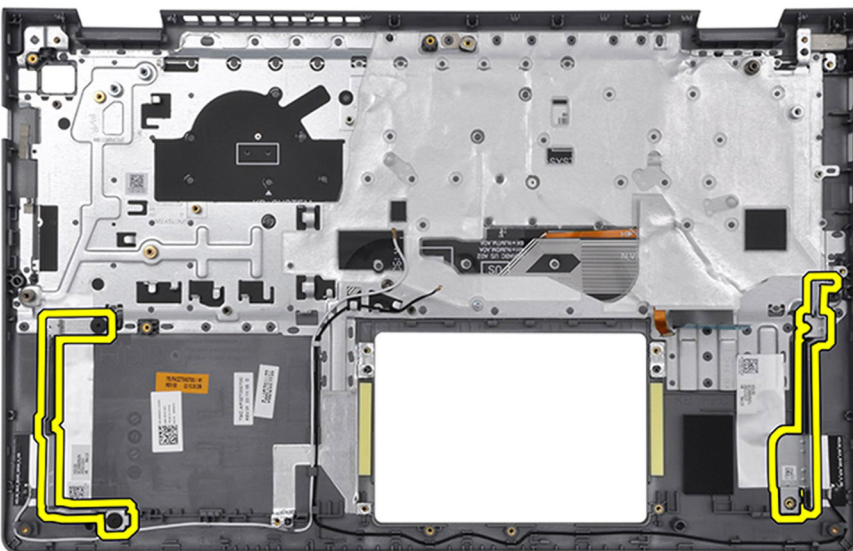

Next steps

1. Install the [system board](#).
2. Install the [power button](#).
3. Install the [power-adapter port](#).
4. Install the [display assembly](#).
5. Install the [touchpad](#).
6. Install the [I/O board](#).
7. Install the [UMA heat sink](#) or [discrete heat sink](#), whichever applicable.
8. Install the [fan](#).
9. Install the [speakers](#).
10. Install the [wireless card](#).
11. Install the [memory modules](#).
12. Install the [M.2 2230 solid-state drive](#) or [M.2 2280 solid-state drive](#) (whichever applicable).

13. Install the [3-cell battery](#) or [4-cell battery](#) (whichever applicable).
14. Install the [base cover](#).
15. Install the [SD card](#).
16. Follow the procedure in [After working inside your computer](#).

Software

This chapter details the supported operating systems along with instructions on how to install the drivers.

Operating system

Your Vostro 15 3535 supports the following operating systems:

- Windows 11 Home, 64-bit
- Windows 11 Pro, 64-bit
- Windows 11 Pro National Academic, 64-bit
- Ubuntu Linux 22.04 LTS, 64-bit

Drivers and downloads

When troubleshooting, downloading or installing drivers it is recommended that you read the Dell Knowledge Base article, Drivers and Downloads FAQ [000123347](#).

BIOS setup

CAUTION: Unless you are an expert computer user, do not change the settings in the BIOS Setup program. Certain changes can make your computer work incorrectly.

NOTE: Depending on the computer and its installed devices, the items listed in this section may or may not be displayed.

NOTE: Before you change BIOS Setup program, it is recommended that you write down the BIOS Setup program screen information for future reference.

Use the BIOS Setup program for the following purposes:

- Get information about the hardware installed in your computer, such as the amount of RAM and the size of the hard drive.
- Change the system configuration information.
- Set or change a user-selectable option, such as the user password, type of hard drive installed, and enabling or disabling base devices.

Entering BIOS setup program

About this task

Turn on (or restart) your computer and press F2 immediately.

Navigation keys

NOTE: For most of the System Setup options, changes that you make are recorded but do not take effect until you restart the system.

Table 30. Navigation keys

Keys	Navigation
Up arrow	Moves to the previous field.
Down arrow	Moves to the next field.
Enter	Selects a value in the selected field (if applicable) or follow the link in the field.
Spacebar	Expands or collapses a drop-down list, if applicable.
Tab	Moves to the next focus area. NOTE: For the standard graphics browser only.
Esc	Moves to the previous page until you view the main screen. Pressing Esc in the main screen displays a message that prompts you to save any unsaved changes and restarts the system.

One time boot menu

To enter **one time boot menu**, turn on your computer, and then press F2 immediately.

NOTE: It is recommended to shutdown the computer if it is on.

The one-time boot menu displays the devices that you can boot from including the diagnostic option. The boot menu options are:

- Removable Drive (if available)
- STXXXX Drive (if available)
 - ⓘ **NOTE:** XXX denotes the SATA drive number.
- Optical Drive (if available)
- SATA Hard Drive (if available)
- Diagnostics
 - ⓘ **NOTE:** Choosing **Diagnostics**, will display the **ePSA diagnostics** screen.

The boot sequence screen also displays the option to access the System Setup screen.

System setup options

ⓘ **NOTE:** Depending on your computer and its installed devices, the items listed in this section may or may not appear.

Table 31. System setup options—Main menu

Main	
System Time	Displays the current time in hh:mm:ss format.
System Date	Displays the current date in mm/dd/yyyy format.
BIOS Version	Displays the BIOS version.
Product Name	Displays the model number of your computer.
Service Tag	Displays the service tag of your computer.
Asset Tag	Displays the asset tag of your computer.
CPU Type	Displays the processor type.
CPU Speed	Displays the processor speed.
CPU ID	Displays the processor identification code.
CPU Cache	
L1 Cache	Displays the processor L1 cache size.
L2 Cache	Displays the processor L2 cache size.
L3 Cache	Displays the processor L3 cache size.
First HDD	Displays the type of hard drive installed.
M.2 PCIe SSD	Displays the PCIe SSD information connected to the M.2 slot.
AC Adapter Type	Displays the type of AC adapter.
System Memory	Displays the size of memory installed.
Memory Speed	Displays the speed of memory.
Keyboard Type	Displays the type of keyboard installed on the computer.

Table 32. System setup options—Advanced menu

Advanced	
Integrated NIC	Enables or disables the on-board LAN controller. Default: Enabled
USB Emulation	Enables or disables the USB emulation feature. This feature defines how the BIOS, in the absence of a USB-aware

Table 32. System setup options—Advanced menu (continued)

Advanced	
	operating system, handles USB devices. USB emulation is always enabled during POST. i NOTE: You cannot boot any type of USB device (floppy, hard drive, or memory key) when this option is off. Default: Enabled
SATA/NVMe Operation mode	Allows you to configure the operating mode of the integrated SATA hard drive controller. Default: AHCI /NVMe
Adapter Warnings	Allows you to choose if the computer should display warning messages when you use AC adapters that are not supported by your computer. Default: Enabled
Function Key Behavior	Allows you to set function key or multimedia key as the default function key behavior. Default: Multimedia key
Battery Health	Displays the battery health.
External USB Ports	Allows you to enable or disable the external USB ports. Default: Enabled
Microphone	Allows you to enable or disable the microphone. Default: Enabled
Camera	Enables or disables the camera. Default: Enabled
Internal WLAN	Enables or disables the internal WLAN. Default: Enabled
Secure Digital (SD) card	Enables or disables the SD card. Default: Enabled
Fingerprint reader	Allows you to enable or disable the fingerprint reader. Default: Enabled
Boot Disable	Default: Disabled
Camera	Enables or disables the camera. Default: Enabled
Battery Charge Configuration	Set the battery charge settings with a preselected custom charge start and stop. Default: Adaptive
Advanced Battery Charge Configuration	Enable Advanced Battery Charge Configuration from the beginning of the day to a specified work period. Default: Disabled
IPv4 HTTP Support	Default: Disabled
IPv6 HTTP Support	Default: Disabled
Maintenance	

Table 32. System setup options—Advanced menu (continued)

Advanced	
Data Wipe on next boot	Enables or disables data wipe on the next boot. Default: Disabled
BIOS Recovery from Hard Drive	Enables the user to recover from certain corrupted BIOS conditions from a recovery file on the user primary hard drive or an external USB key. Default: Enabled
BIOS Auto-Recovery	Enables BIOS to automatically recover BIOS without user actions. Default: Disabled
SupportAssist System Resolution	
Auto OS Recovery Threshold	Controls the automatic boot flow for SupportAssist System Resolution Console and for the Dell OS Recovery tool. Default: 2
SupportAssist OS Recovery	Enables or disables the boot flow for the SupportAssist OS Recovery tool in the even of certain system errors. Default: Enabled

Table 33. System setup options—Security menu

Security	
Admin Password	Displays if the administrator password is clear or set. Default: Not Set
System Password	Displays if the system password is clear or set. Default: Not Set
Asset Tag	
Admin Password	Set your system's Asset Tag. Allows you to set the administrator password. The administrator password controls access to the system setup utility.
System Password	Allows you to set the system password. The system password controls access to the computer at boot.
Password Change	Allows you to permit or deny system password or HDD password changes. Default: Permitted
Password Bypass	Allows you to bypass system password. Default: Disabled
Absolute®	Allows you to track your computer Default: Enabled
Absolute® Status	Allows you to activate or deactivate the Absolute® feature Displays if the system password is clear or set. Default: Deactivate
WINDOWS SMM SECURITY MITIGATIONS TABLE (WSMT)	Enables or disables configuration of platform features on Dell Client Systems with WSMT-enabled BIOS. Default: Enabled

Table 33. System setup options—Security menu (continued)

Security	
Firmware TPM	Enable or disable the firmware TPM. Default: Disabled
PPI Bypass for Clear Command	Allows you to control the TPM Physical Presence Interface (PPI). When enabled, this setting will allow the OS to skip BIOS PPI user prompts when issuing the Clear command. Changes to this setting take effect immediately. Default: Disabled
TPM Security	
TPM On	TPM 2.0 Security options. Default: On
PPI Bypass for Enable Commands	Default: Disabled
PPI Bypass for Disable Commands	Default: Disabled
Attestation Enable	Default: Enabled
Key Storage Enable	Default: Enabled
SHA-256	Default: Enabled
Clear	Default: Disabled
PPI Bypass for Clear Command	Default: Disabled
TPM State	Default: Enabled
Enable Pre-Boot DMA support	Enable or disable the pre-boot DMA support. Default: Enabled
Enable OS kernel DMA support	Enable or disable the OS kernel DMA support. Default: Enabled
UEFI Firmware Capsule Updates	Enables or disables BIOS updates through UEFI capsule update packages. Default: Enabled
Secure Boot	
	Enables or disables Secure Boot. Default: Enabled
System Status:	Installed and Locked
Secure Boot Database	
Secure Boot Status	Disabled
Secure Boot Mode	Deployed Mode
User Customized Security	No
Options:	
Secure Boot	Default: Disabled
Select Secure Mode	Default: Deployed Mode
Expert Key Management	
Custom Mode	Default: Disabled
Enable Microsoft UEFI CA	Default: Enabled
PK	
KEK	
db	

Table 33. System setup options—Security menu (continued)

Security	
dbx	

Table 34. System setup options—Boot menu

Boot	
Boot List Option	UEFI
File Browser Add Boot Option	
Windows Boot Manager	:\EFI\Microsoft\Boot\bootmgfw.efi
File Browser Del Boot Option	
Windows Boot Manager	:\EFI\Microsoft\Boot\bootmgfw.efi
UEFI BOOT:	
HDD1-Windows Boot Manager	
Onboard NIC (IPV4 PXE)	
Onboard NIC (IPV6 PXE)	

Table 35. System setup options—Exit menu

Exit	
Exit Saving Changes	Allows you to exit system setup and save your changes.
Save Change Without Exit	Allows you to save your changes without exiting the BIOS setup.
Exit Discarding Changes	Allows you to exit the BIOS setup without saving the changes.
Load Optimal Defaults	Allows you to restore default values for all system setup options.
Discard Changes	Allows you to load previous values for all system setup options.

Updating the BIOS

Updating the BIOS in Windows

Steps

1. Go to www.dell.com/support.
2. Click **Product support**. In the **Search support** box, enter the Service Tag of your computer, and then click **Search**.

 **NOTE:** If you do not have the Service Tag, use the SupportAssist feature to automatically identify your computer. You can also use the product ID or manually browse for your computer model.
3. Click **Drivers & Downloads**. Expand **Find drivers**.
4. Select the operating system installed on your computer.
5. In the **Category** drop-down list, select **BIOS**.
6. Select the latest version of BIOS, and click **Download** to download the BIOS file for your computer.
7. After the download is complete, browse the folder where you saved the BIOS update file.
8. Double-click the BIOS update file icon and follow the on-screen instructions.

For more information about how to update the system BIOS, search in the Knowledge Base Resource at www.dell.com/support.

Updating the BIOS using the USB drive in Windows

Steps

1. Follow the procedure from step 1 to step 6 in [Updating the BIOS in Windows](#) to download the latest BIOS setup program file.
2. Create a bootable USB drive. For more information, search the Knowledge Base Resource at www.dell.com/support.
3. Copy the BIOS setup program file to the bootable USB drive.
4. Connect the bootable USB drive to the computer that needs the BIOS update.
5. Restart the computer and press **F12**.
6. Select the USB drive from the **One Time Boot Menu**.
7. Type the BIOS setup program filename and press **Enter**.
The **BIOS Update Utility** appears.
8. Follow the on-screen instructions to complete the BIOS update.

Updating the BIOS in Linux and Ubuntu

To update the system BIOS on a computer that is installed with Linux or Ubuntu, see the knowledge base article [000131486](#) at www.dell.com/support.

Updating the BIOS from the F12 One Time Boot menu

Update your computer BIOS using the BIOS update.exe file that is copied to a FAT32 USB drive and booting from the F12 **One Time Boot** menu.

About this task

BIOS Update

You can run the BIOS update file from Windows using a bootable USB drive or you can also update the BIOS from the F12 **One Time Boot** menu on the computer.

Most of the Dell computers built after 2012 have this capability, and you can confirm by booting your computer to the F12 **One Time Boot** Menu to see if BIOS FLASH UPDATE is listed as a boot option for your computer. If the option is listed, then the BIOS supports this BIOS update option.

 **NOTE:** Only computers with BIOS Flash Update option in the F12 **One Time Boot** menu can use this function.

Updating from the One Time Boot menu

To update your BIOS from the F12 **One Time Boot** menu, you need the following:

- USB drive formatted to the FAT32 file system (key does not have to be bootable)
- BIOS executable file that you downloaded from the Dell Support website and copied to the root of the USB drive
- AC power adapter that is connected to the computer
- Functional computer battery to flash the BIOS

Perform the following steps to perform the BIOS update flash process from the F12 menu:

 **CAUTION:** Do not turn off the computer during the BIOS update process. The computer may not boot if you turn off your computer.

Steps

1. From a turn off state, insert the USB drive where you copied the flash into a USB port of the computer.
2. Turn on the computer and press F12 to access the **One Time Boot** Menu, select BIOS Update using the mouse or arrow keys then press Enter.
The flash BIOS menu is displayed.
3. Click **Flash from file**.
4. Select external USB device.
5. Select the file and double-click the flash target file, and then click **Submit**.
6. Click **Update BIOS**. The computer restarts to flash the BIOS.

7. The computer will restart after the BIOS update is completed.

System and setup password

Table 36. System and setup password

Password type	Description
System password	Password that you must enter to log in to your system.
Setup password	Password that you must enter to access and make changes to the BIOS settings of your computer.

You can create a system password and a setup password to secure your computer.

 **CAUTION:** The password features provide a basic level of security for the data on your computer.

 **CAUTION:** Anyone can access the data that is stored on your computer if it is not locked and left unattended.

 **NOTE:** System and setup password feature is disabled.

Assigning a system setup password

Prerequisites

You can assign a new **System or Admin Password** only when the status is in **Not Set**.

About this task

To enter the system setup, press F12 immediately after a power-on or reboot.

Steps

1. In the **System BIOS** or **System Setup** screen, select **Security** and press Enter.
The **Security** screen is displayed.
2. Select **System/Admin Password** and create a password in the **Enter the new password** field.
Use the following guidelines to assign the system password:
 - A password can have up to 32 characters.
 - At least one special character: ! " # \$ % & ' () * + , - . / : ; < = > ? @ [\] ^ _ ` { | }
 - Numbers 0 through 9.
 - Upper case letters from A to Z.
 - Lower case letters from a to z.
3. Type the system password that you entered earlier in the **Confirm new password** field and click **OK**.
4. Press Esc and save the changes as prompted by the pop-up message.
5. Press Y to save the changes.
The computer restarts.

Deleting or changing an existing system setup password

Prerequisites

Ensure that the **Password Status** is Unlocked (in the System Setup) before attempting to delete or change the existing System and/or Setup password. You cannot delete or change an existing System or Setup password, if the **Password Status** is Locked.

About this task

To enter the System Setup, press F12 immediately after a power-on or reboot.

Steps

1. In the **System BIOS** or **System Setup** screen, select **System Security** and press Enter.
The **System Security** screen is displayed.
2. In the **System Security** screen, verify that **Password Status** is **Unlocked**.
3. Select **System Password**, update, or delete the existing system password, and press Enter or Tab.
4. Select **Setup Password**, update, or delete the existing setup password, and press Enter or Tab.
 **NOTE:** If you change the System and/or Setup password, reenter the new password when prompted. If you delete the System and/or Setup password, confirm the deletion when prompted.
5. Press Esc and a message prompts you to save the changes.
6. Press Y to save the changes and exit from System Setup.
The computer restarts.

Clearing BIOS (System Setup) and System passwords

About this task

To clear the system or BIOS passwords, contact Dell technical support as described at www.dell.com/contactdell.

-  **NOTE:** For information on how to reset Windows or application passwords, refer to the documentation accompanying Windows or your application.

Troubleshooting

Handling swollen Lithium-ion batteries

Like most laptops, Dell laptops use lithium-ion batteries. One type of lithium-ion battery is the lithium-ion polymer battery. Lithium-ion polymer batteries have increased in popularity in recent years and have become standard in the electronics industry due to customer preferences for a slim form factor (especially with newer ultra-thin laptops) and long battery life. Inherent to lithium-ion polymer battery technology is the potential for swelling of the battery cells.

Swollen battery may impact the performance of the laptop. To prevent possible further damage to the device enclosure or internal components leading to malfunction, discontinue the use of the laptop and discharge it by disconnecting the AC adapter and letting the battery drain.

Swollen batteries should not be used and should be replaced and disposed of properly. We recommend contacting Dell product support for options to replace a swollen battery under the terms of the applicable warranty or service contract, including options for replacement by a Dell authorized service technician.

The guidelines for handling and replacing Lithium-ion batteries are as follows:

- Exercise caution when handling Lithium-ion batteries.
- Discharge the battery before removing it from the system. To discharge the battery, unplug the AC adapter from the system and operate the system only on battery power. When the system will no longer power on when the power button is pressed, the battery is fully discharged.
- Do not crush, drop, mutilate, or penetrate the battery with foreign objects.
- Do not expose the battery to high temperatures, or disassemble battery packs and cells.
- Do not apply pressure to the surface of the battery.
- Do not bend the battery.
- Do not use tools of any type to pry on or against the battery.
- If a battery gets stuck in a device as a result of swelling, do not try to free it as puncturing, bending, or crushing a battery can be dangerous.
- Do not attempt to reassemble a damaged or swollen battery into a laptop.
- Swollen batteries that are covered under warranty should be returned to Dell in an approved shipping container (provided by Dell)—this is to comply with transportation regulations. Swollen batteries that are not covered under warranty should be disposed of at an approved recycling center. Contact Dell product support at <https://www.dell.com/support> for assistance and further instructions.
- Using a non-Dell or incompatible battery may increase the risk of fire or explosion. Replace the battery only with a compatible battery purchased from Dell that is designed to work with your Dell computer. Do not use a battery from other computers with your computer. Always purchase genuine batteries from <https://www.dell.com> or otherwise directly from Dell.

Lithium-ion batteries can swell for various reasons such as age, number of charge cycles, or exposure to high heat. For more information on how to improve the performance and lifespan of the laptop battery and to minimize the possibility of occurrence of the issue, search Dell Laptop Battery in the Knowledge Base Resource at www.dell.com/support.

Locate the Service Tag or Express Service Code of your Dell computer

Your Dell computer is uniquely identified by a Service Tag or Express Service Code. To view relevant support resources for your Dell computer, we recommend entering the Service Tag or Express Service Code at www.dell.com/support.

For more information on how to find the Service Tag for your computer, see [Locate the Service Tag on your computer](#).

Dell SupportAssist Pre-boot System Performance Check diagnostics

About this task

SupportAssist diagnostics (also known as system diagnostics) performs a complete check of your hardware. The Dell SupportAssist Pre-boot System Performance Check diagnostics is embedded with the BIOS and is launched by the BIOS internally. The embedded system diagnostics provides a set of options for particular devices or device groups allowing you to:

- Run tests automatically or in an interactive mode
- Repeat tests
- Display or save test results
- Run thorough tests to introduce additional test options to provide extra information about the failed device(s)
- View status messages that inform you if tests are completed successfully
- View error messages that inform you of problems encountered during testing

 **NOTE:** Some tests for specific devices require user interaction. Always ensure that you are present at the computer terminal when the diagnostic tests are performed.

For more information, see <https://www.dell.com/support/kbdoc/000180971>.

Running the SupportAssist Pre-Boot System Performance Check

Steps

1. Turn on your computer.
2. As the computer boots, press the F12 key as the Dell logo appears.
3. On the boot menu screen, select the **Diagnostics** option.
4. Click the arrow at the bottom left corner.
Diagnostics front page is displayed.
5. Click the arrow in the lower-right corner to go to the page listing.
The items detected are listed.
6. To run a diagnostic test on a specific device, press Esc and click **Yes** to stop the diagnostic test.
7. Select the device from the left pane and click **Run Tests**.
8. If there are any issues, error codes are displayed.
Note the error code and validation number and contact Dell.

Built-in self-test (BIST)

M-BIST

M-BIST (Built In Self-Test) is the system board's built-in self-test diagnostics tool that improves the diagnostics accuracy of system board embedded controller (EC) failures.

 **NOTE:** M-BIST can be manually initiated before POST (Power On Self Test).

How to run M-BIST

 **NOTE:** M-BIST must be initiated on the system from a power-off state either connected to AC power or with battery only.

1. Press and hold both the **M** key on the keyboard and the **power button** to initiate M-BIST.
2. With both the **M** key and the **power button** held down, the battery indicator LED may exhibit two states:
 - a. OFF: No fault detected with the system board
 - b. AMBER: Indicates a problem with the system board
3. If there is a failure with the system board, the battery status LED will flash one of the following error codes for 30 seconds:

Table 37. LED error codes

Blinking Pattern		Possible Problem
Amber	White	
2	1	CPU Failure
2	8	LCD Power Rail Failure
1	1	TPM Detection Failure
2	4	Memory/RAM failure

4. If there is no failure with the system board, the LCD will cycle through the solid color screens described in the LCD-BIST section for 30 seconds and then power off.

LCD Power rail test (L-BIST)

L-BIST is an enhancement to the single LED error code diagnostics and is automatically initiated during POST. L-BIST will check the LCD power rail. If there is no power being supplied to the LCD (that is if the L-BIST circuit fails), the battery status LED will flash either an error code [2,8] or an error code [2,7].

 **NOTE:** If L-BIST fails, LCD-BIST cannot function as no power will be supplied to the LCD.

How to invoke L-BIST Test:

1. Press the power button to start the system.
2. If the system does not start up normally, look at the battery status LED:
 - If the battery status LED flashes an error code [2,7], the display cable may not be connected properly.
 - If the battery status LED flashes an error code [2,8], there is a failure on the LCD power rail of the system board, hence there is no power supplied to the LCD.
3. For cases, when a [2,7] error code is shown, check to see if the display cable is properly connected.
4. For cases when a [2,8] error code is shown, replace the system board.

LCD Built-in Self Test (BIST)

Dell laptops have a built-in diagnostic tool that helps you determine if the screen abnormality you are experiencing is an inherent problem with the LCD (screen) of the Dell laptop or with the video card (GPU) and PC settings.

When you notice screen abnormalities like flickering, distortion, clarity issues, fuzzy or blurry image, horizontal or vertical lines, color fade etc., it is always a good practice to isolate the LCD (screen) by running the Built-In Self Test (BIST).

How to invoke LCD BIST Test

1. Power off the Dell laptop.
2. Disconnect any peripherals that are connected to the laptop. Connect only the AC adapter (charger) to the laptop.
3. Ensure that the LCD (screen) is clean (no dust particles on the surface of the screen).
4. Press and hold **D** key and **Power on** the laptop to enter LCD built-in self test (BIST) mode. Continue to hold the D key, until the system boots up.
5. The screen will display solid colors and change colors on the entire screen to white, black, red, green, and blue twice.
6. Then it will display the colors white, black and red.
7. Carefully inspect the screen for abnormalities (any lines, fuzzy color or distortion on the screen).
8. At the end of the last solid color (red), the system will shut down.

 **NOTE:** Dell SupportAssist Pre-boot diagnostics upon launch, initiates an LCD BIST first, expecting a user intervention confirm functionality of the LCD.

System-diagnostic lights

This section lists the system-diagnostic lights of your Vostro 15 3535.

Power and battery-status light

The power and battery status light indicates the power and battery status of the computer. These are the power states:

Solid white:Power adapter is connected and the battery has more than 5% charge.

Amber:Computer is running on battery and the battery has less than 5% charge.

Off:

- Power adapter is connected, and the battery is fully charged.
- Computer is running on battery, and the battery has more than 5% charge.
- Computer is in sleep state, hibernation, or turned off.

The power and battery-status light may blink amber or white according to pre-defined "beep codes" indicating various failures.

For example, the power and battery-status light blinks amber two times followed by a pause, and then blinks white three times followed by a pause. This 2,3 pattern continues until the computer is turned off, indicating no memory or RAM is detected.

The following table shows different power and battery-status light patterns and associated problems.

NOTE: The following diagnostic light codes and recommended solutions are intended for Dell service technicians to troubleshoot problems. You should only perform troubleshooting and repairs as authorized or directed by the Dell technical assistance team. Damage due to servicing that is not authorized by Dell is not covered by your warranty.

Table 38. System-diagnostic lights

Blinking pattern		Problem description	Suggested resolution
Amber	White		
2	1	CPU failure	<ul style="list-style-type: none"> • Run the Dell Support Assist/Dell Diagnostics tool. • If problem persists, replace the system board.
2	2	System board failure (included BIOS corruption or ROM error)	<ul style="list-style-type: none"> • Flash latest BIOS version • If problem persists, replace the system board.
2	3	No memory/RAM detected	<ul style="list-style-type: none"> • Confirm that the memory module is installed properly. • If problem persists, replace the memory module.
2	4	Memory/RAM failure	<ul style="list-style-type: none"> • Reset and swap memory modules among the slots. • If problem persists, replace the memory module.
2	5	Invalid memory installed	<ul style="list-style-type: none"> • Reset and swap memory modules among the slots. • If problem persists, replace the memory module.
2	6	System board/Chipset Error	Replace the system board.
2	7	LCD failure (SBIOS message)	Replace the LCD module.
2	8	LCD failure (EC detection of power rail failure)	Replace the system board.

Table 38. System-diagnostic lights (continued)

Blinking pattern		Problem description	Suggested resolution
Amber	White		
3	1	CMOS battery failure	<ul style="list-style-type: none"> Reset the main battery connection. If problem persists, replace the main battery.
3	2	PCI or Video card/chip failure	Replace the system board.
3	3	BIOS Recovery image not found	<ul style="list-style-type: none"> Flash latest BIOS version If problem persists, replace the system board.
3	4	BIOS Recovery image found but invalid	<ul style="list-style-type: none"> Flash latest BIOS version If problem persists, replace the system board.
3	5	Power rail failure	Replace the system board.
3	6	Flash corruption detected by SBIOS.	<ul style="list-style-type: none"> Press power button for over 25 seconds to do RTC reset. If problem persists, replace the system board. Disconnect all power source (AC, battery, coin cell) and drain flea power by pressing and holding down power button 3~5 seconds to ensure all power are drained. Run "BIOS recovery from USB", and the instructions are in the website Dell support. If problem persists, replace the system board.

NOTE: Blinking 3-3-3 LEDs on Lock LED (Caps-Lock or Nums-Lock), Power button LED (without Fingerprint reader), and Diagnostic LED indicates failure to provide input during LCD panel test on Dell SupportAssist Pre-boot System Performance Check diagnostics.

Recovering the operating system

When your computer is unable to boot to the operating system even after repeated attempts, it automatically starts Dell SupportAssist OS Recovery.

Dell SupportAssist OS Recovery is a standalone tool that is preinstalled in all Dell computers installed with Windows operating system. It consists of tools to diagnose and troubleshoot issues that may occur before your computer boots to the operating system. It enables you to diagnose hardware issues, repair your computer, back up your files, or restore your computer to its factory state.

You can also download it from the Dell Support website to troubleshoot and fix your computer when it fails to boot into their primary operating system due to software or hardware failures.

For more information about the Dell SupportAssist OS Recovery, see *Dell SupportAssist OS Recovery User's Guide* at www.dell.com/serviceabilitytools. Click **SupportAssist** and then, click **SupportAssist OS Recovery**.

Real-Time Clock (RTC Reset)

The Real Time Clock (RTC) reset function allows you or the service technician to recover Dell systems from No POST/No Power/No Boot situations. The legacy jumper enabled RTC reset has been retired on these models.

Start the RTC reset with the system powered off and connected to AC power. Press and hold the power button for thirty (30) seconds

. The system RTC Reset occurs after you release the power button.

Backup media and recovery options

It is recommended to create a recovery drive to troubleshoot and fix problems that may occur with Windows. Dell proposes multiple options for recovering Windows operating system on your Dell PC. For more information, see [Dell Windows Backup Media and Recovery Options](#).

Wi-Fi power cycle

About this task

If your computer is unable to access the Internet due to Wi-Fi connectivity issues a Wi-Fi power cycle procedure may be performed. The following procedure provides the instructions on how to conduct a Wi-Fi power cycle:

 **NOTE:** Some ISPs (Internet Service Providers) provide a modem/router combo device.

Steps

1. Turn off your computer.
2. Turn off the modem.
3. Turn off the wireless router.
4. Wait for 30 seconds.
5. Turn on the wireless router.
6. Turn on the modem.
7. Turn on your computer.

Drain residual flea power (perform hard reset)

About this task

Flea power is the residual static electricity that remains in the computer even after it has been powered off and the battery is removed.

For your safety, and to protect the sensitive electronic components in your computer, you are requested to drain residual flea power before removing or replacing any components in your computer.

Draining residual flea power, also known as a performing a "hard reset", is also a common troubleshooting step if your computer does not power on or boot into the operating system.

To drain residual flea power (perform a hard reset)

Steps

1. Turn off your computer.
2. Disconnect the power adapter from your computer.
3. Remove the base cover.
4. Remove the battery.
5. Press and hold the power button for 20 seconds to drain the flea power.
6. Install the battery.

7. Install the base cover.
8. Connect the power adapter to your computer.
9. Turn on your computer.



 **NOTE:** For more information about performing a hard reset, search in the Knowledge Base Resource at www.dell.com/support.

Getting help and contacting Dell

Self-help resources

You can get information and help on Dell products and services using these self-help resources:

Table 39. Self-help resources

Self-help resources	Resource location
Information about Dell products and services	www.dell.com
My Dell app	
Tips	
Contact Support	In Windows search, type <code>Contact Support</code> , and press Enter.
Online help for operating system	www.dell.com/support/windows
Access top solutions, diagnostics, drivers and downloads, and learn more about your computer through videos, manuals and documents.	Your Dell computer is uniquely identified by a Service Tag or Express Service Code. To view relevant support resources for your Dell computer, enter the Service Tag or Express Service Code at www.dell.com/support . For more information on how to find the Service Tag for your computer, see Locate the Service Tag on your computer .
Dell knowledge base articles for a variety of computer concerns	<ol style="list-style-type: none"> 1. Go to www.dell.com/support. 2. On the menu bar at the top of the Support page, select Support > Knowledge Base. 3. In the Search field on the Knowledge Base page, type the keyword, topic, or model number, and then click or tap the search icon to view the related articles.

Contacting Dell

To contact Dell for sales, technical support, or customer service issues, see www.dell.com/contactdell.

 **NOTE:** Availability varies by country/region and product, and some services may not be available in your country/region.

 **NOTE:** If you do not have an active Internet connection, you can find contact information about your purchase invoice, packing slip, bill, or Dell product catalog.

Ovaj dokument je originalno proizveden i objavljen od strane proizvođača, brenda Dell, i preuzet je sa njihove zvanične stranice. S obzirom na ovu činjenicu, Tehnoteka ističe da ne preuzima odgovornost za tačnost, celovitost ili pouzdanost informacija, podataka, mišljenja, saveta ili izjava sadržanih u ovom dokumentu.

Napominjemo da Tehnoteka nema ovlašćenje da izvrši bilo kakve izmene ili dopune na ovom dokumentu, stoga nismo odgovorni za eventualne greške, propuste ili netačnosti koje se mogu naći unutar njega. Tehnoteka ne odgovara za štetu nanесenu korisnicima pri upotrebi netačnih podataka. Ukoliko imate dodatna pitanja o proizvodu, ljubazno vas molimo da kontaktirate direktno proizvođača kako biste dobili sve detaljne informacije.

Za najnovije informacije o ceni, dostupnim akcijama i tehničkim karakteristikama proizvoda koji se pominje u ovom dokumentu, molimo posetite našu stranicu klikom na sledeći link:

<https://tehnoteka.rs/p/dell-laptop-vostro-3535-not22361-akcija-cena/>