

Uputstvo za upotrebu (EN)

THERMALTAKE kućište Versa J21



Tehnoteka je online destinacija za upoređivanje cena i karakteristika bele tehnike, potrošačke elektronike i IT uređaja kod trgovinskih lanaca i internet prodavnica u Srbiji. Naša stranica vam omogućava da istražite najnovije informacije, detaljne karakteristike i konkurentne cene proizvoda.

Posetite nas i uživajte u ekskluzivnom iskustvu pametne kupovine klikom na link:

<https://tehnoteka.rs/p/thermaltake-kuciste-versa-j21-akcija-cena/>

Versa J21 TG

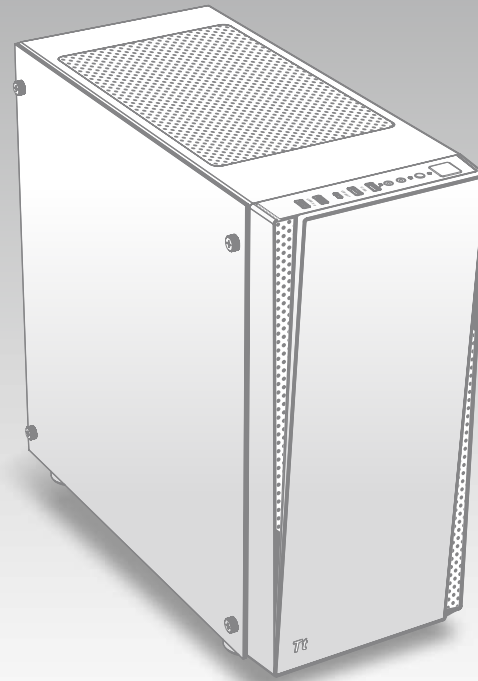

User's Manual
Benutzerhandbuch
Mode d'emploi
Manual del usuario
Manuale dell'utente
Manual do Utilizador
安裝說明書
用戶手冊
ユーザーズマニュアル
Руководство пользователя
kullanıcı elkitabı
(EEE Yönetmeliğine Uygundur)
คู่มือการใช้



© 2017 Thermaltake Technology Co., Ltd. All Rights Reserved. A-2017.12
All other registered trademarks belong to their respective companies. www.thermaltake.com

CONTENTS

Chapter 1. Product Introduction

1.1 Specification	02
1.2 Accessory	02
1.3 Warning and Notice	03

Chapter 2. Installation Guide

2.1 Side Panel Disassembly	05
2.2 PSU Installation	06
2.3 Motherboard Installation	07
2.4 3.5" & 2.5" HDD Installation	08
2.5 PCI Slot Usage	09
2.6 Radiator Installation	10
2.7 Air Cooling Installation	10

Chapter 3. Leads Installation

3.1 Case LED Connection	11
3.2 USB 2.0 Connection	11
3.3 USB 3.0 Connection	11
3.4 Audio Connection	11

Chapter 4. Other

4.1 Thermaltake Power Supply Series (Optional).....	17
---	----

*Picture for reference only





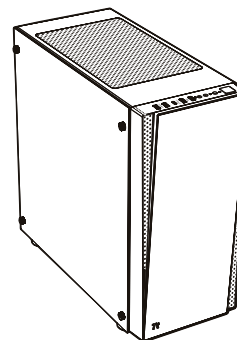





*Information in the user manual is subject to change without notice

Specification



Model	Versa J21 TG
Case Type	Middle tower
Dimension(H*W*D)	465 x 205 x 447 mm (18.3 x 8.1 x 17.5 inch)
Side Panel	4mm Tempered Glass x 1 (Left)
Material	SPCC
Cooling System	Rear (exhaust): 120 x 120 x 25 mm fan (1000rpm, 16dBA)
Fan Support	Front: 3 x 120mm, 2 x 140mm Top: 2 x 120mm, 2 x 140mm Rear: 1 x 120mm
Drive Bays - Accessible - Hidden	2 x 3.5" or 2 x 2.5" (HDD Tray); 2 x 2.5" (HDD Bracket) 2 x 2.5"
Radiator Support	Front: 1 x 360mm, 1 x 280mm Top: 1 x 240mm Rear: 1 x 120mm
Clearance	CPU cooler height limitation: 160mm VGA length limitation: 310mm PSU length limitation: 220mm

Accessory

Figure	Parts Name	Q'ty	Used for
 	Screw #6-32 x 6.5mm	3	Pillars
 	Screw #6-32 x 6mm	6	Power Supply
 	Screw #6-32 x 6mm	8	Motherboard/3.5" HDD
 	Screw M3 x 5mm	18	2.5" HDD
 	Screw #6-32 x 28mm	8	Fans
 	Screw T5 x 10mm	12	Fans
	Movable Tie	4	Cable Management

Warning and Notice

CPU Cooler Height Limitation

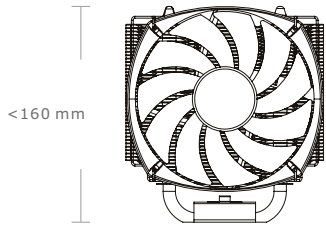

VGA (Add-on card) Length Limitation

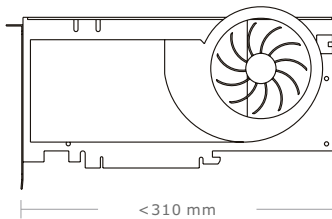

Warning!!

- Height limit for the CPU heatsink:
The height limit for the CPU heatsink is 160 mm (6.3 inches).
- Length limit for the VGA (graphics card):
The length limit for the VGA (graphics card) is 310 mm (12.2 inches).

Warnung!!

- Höhenbeschränkung für CPU-Kühler:
Die Höhenbeschränkung für den CPU-Kühler liegt bei 160 mm (6,3 Zoll).
- Längenbeschränkung für die VGA (Grafikkarte):
Die Längenbeschränkung für die VGA (Grafikkarte) beträgt 310 mm (12,2 Zoll).

Avertissement !

- Hauteur limite du dissipateur thermique du processeur :
La hauteur limite du dissipateur thermique du processeur est de 160 mm (6,3 pouces).
- Longueur limite de la carte VGA (carte graphique) :
La longueur limite de la carte VGA (carte graphique) est de 310 mm (12,2 pouces).

Precaución

- Límite de altura para el disipador de calor de la CPU:
El límite de altura para el disipador de calor de la CPU es de 160 mm (6,3 pulgadas).
- Límite de longitud para la tarjeta gráfica (VGA):
El límite de longitud para la tarjeta gráfica (VGA) es de 310 mm (12,2 pulgadas).

Attenzione!

- Limite di altezza per il dissipatore di calore della CPU:
Il limite di altezza per il dissipatore di calore della CPU è 160 mm (6,3").
- Limite di lunghezza per la VGA (scheda grafica):
Il limite di lunghezza per la VGA (scheda grafica) è 310 mm (12,2").

Atenção!!

- Limite de altura para o dissipador do CPU:
O limite de altura para o dissipador do CPU é 160 mm (6,3 polegadas).
- Limite de comprimento para VGA (placa gráfica):
O limite de comprimento para VGA (placa gráfica) é 310 mm (12,2 polegadas).

警告！！

- CPU散熱器の高度限制:
CPU散熱器の高度限制为160mm(6.3英寸)。
- VGA(顯示卡)的長度限制:
VGA(顯示卡)的長度限制为310mm(12.2英寸)。

警告！！

- CPU散热器的高度限制：
CPU散热器的高度限制为160mm（6.3英寸）。
- VGA（显卡）的长度限制：
VGA（显卡）的长度限制为310mm（12.2英寸）。

警告

- CPUヒートシンクの高さ制限:
CPUヒートシンクの高さ制限は160mmです。
- VGA（グラフィックスカード）の長さ制限:
VGA（グラフィックスカード）の長さ制限は310mmです。

Внимание!

- Ограничение по высоте для радиатора ЦП.
Ограничение по высоте для радиатора ЦП составляет 160 мм (6,3 дюйма).
- Ограничение по длине для платы VGA (графическая плата).
Ограничение по длине для платы VGA (графическая плата) составляет 310 мм (12,2 дюйма).

Uyan!!

- CPU ısı alıcısı için yükseklik sınırı:
CPU ısı alıcısı için yükseklik sınırı 160 mm'dir (6,3 inç).
- VGA (grafik kartı) için uzunluk sınırı:
VGA (grafik kartı) için uzunluk sınırı 310 mm'dir (12,2 inç).

คำเตือน!!

- ข้อจำกัดความสูงสำหรับฮีตซิงก์ของ CPU:
ข้อจำกัดความสูงสำหรับฮีตซิงก์ของ CPU คือ 160 มม. (6.3 นิ้ว)
- ข้อจำกัดความยาวสำหรับ VGA (การ์ดแสดงผล):
ข้อจำกัดความยาวสำหรับ VGA (การ์ดแสดงผล) คือ 310 มม. (12.2 นิ้ว)

Side Panel Disassembly

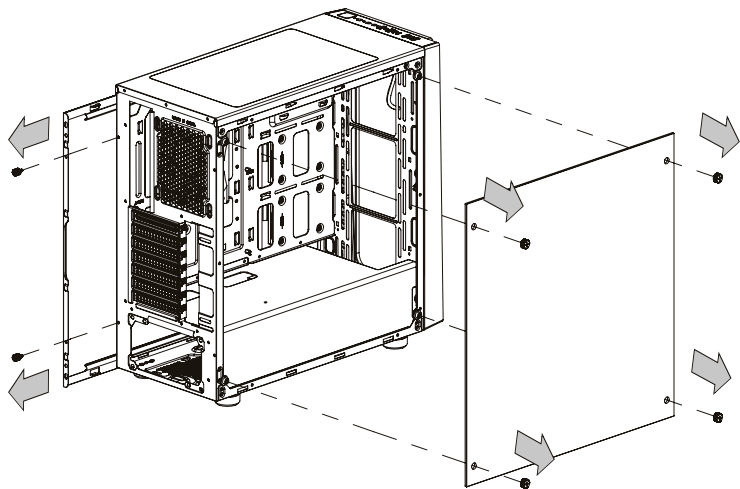

English /
Remove the screws on the back of the chassis,
and open the side panel.

繁體中文 /
移除機殼後方螺絲，將側窗打開。

Deutsch /
Entfernen Sie die Schrauben auf der Rückseite
des Gehäuses und öffnen Sie das Seitenteil.

简体中文 /
卸除机壳后方螺丝，将侧窗打开。

Français /
Enlevez les vis à l'arrière du châssis et ouvrez le
panneau latéral.

日本語 /
シャーシ背面のねじを取り外し、サイドパネ
ルを開きます。

Español /
Extraiga los tornillos de la parte posterior de la
caja y abra el panel lateral.

Русский /
Открутите винты на задней стенке корпуса
и откройте боковую панель.

Italiano /
Rimuovere le viti sulla parte posteriore dello
chassis e aprire il pannello laterale.

Türkçe /
Kasanın arkasındaki vidaları çıkarın ve yan
paneli açın.

Português /
Remova os parafusos na parte de trás da caixa e
abra o painel lateral.

ภาษาไทย /
ถอดสกรูที่ด้านหลังของแชสซีส์
แล้วเปิดแผงด้านข้าง

PSU Installation

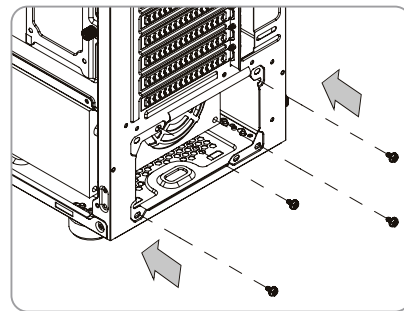

English /
Place the power supply in proper location and
secure it with screws.

繁體中文 /
將電源供應器放在正確的位置，並用螺絲固定
鎖上。

Deutsch /
Installieren Sie das Netzteil an seiner Position und
sichern Sie es mit Schrauben.

简体中文 /
恰当定位电源供应器位置并以螺丝安全固定。

Français /
Mettez l'alimentation dans le bon endroit et
sécurisez-la avec des vis.

日本語 /
電源装置を適切な場所に取り付け、ねじで固
定します。

Español /
Coloque el suministro de alimentación en el lugar
adecuado y asegúrelo con tornillos.

Русский /
Установите блок питания в надлежащее
место и закрепите его винтами.

Italiano /
Posizionare l'alimentatore in modo appropriato e
fissarlo utilizzando le viti.

Türkçe /
Güç kaynağını uygun konuma yerleştirin ve
vidalarla sabitleyin.

Português /
Coloque a fonte de alimentação na devida
localização e aparafuse.

ภาษาไทย /
วางแหล่งจ่ายไฟในตำแหน่งที่เหมาะสมแล้วขันสกรู
ยึดให้แน่น

Motherboard Installation

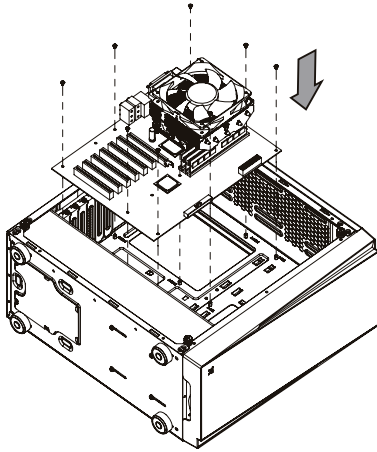

English /

1. Lay down the chassis.
2. Install the motherboard in proper location and secure it with screws.

Deutsch /

1. Legen Sie das Gehäuse auf die Seite.
2. Installieren Sie die Hauptplatine in ihrer vorgesehenen Position und sichern Sie sie mit Schrauben.

Français /

1. Posez à plat le châssis.
2. Installez la carte mère dans l'endroit approprié et sécurisez-la avec des vis.

Español /

1. Tumbel el chasis.
2. Instale la placa madre en la ubicación adecuada y asegúrela con tornillos.

Italiano /

1. Poggiare lo chassis.
2. Installare la scheda madre nella posizione appropriata e fissarla con le viti.

Português /

1. Deixe a caixa.
2. Instale a motherboard no local adequado e aparafuse.

繁體中文 /

1. 將機殼平放。
2. 將主機板放置在合適的位置並用零件包中之螺絲固定。

简体中文 /

1. 放平机箱。
2. 在合适的位置安装主板并以螺丝安全固定。

日本語 /

1. シャーシを下に置きます。
2. マザーボードを適切な場所に取り付け、ねじで固定します。

Русский /

1. Раскройте системный блок.
2. Установите материнскую плату в надлежащее место и закрепите ее винтами.

Türkçe /

1. Kasayı yan yatırın.
2. Ana kartı uygun konuma takın ve vidalarla sabitleyin.

ภาษาไทย /

1. วางแชสซีส์นอนลง
2. ติดตั้งเมนบอร์ดในตำแหน่งที่เหมาะสมแล้วขันสกรูยึดให้แน่น

3.5" & 2.5" HDD Installation

2.5" HDD

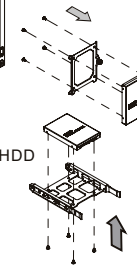
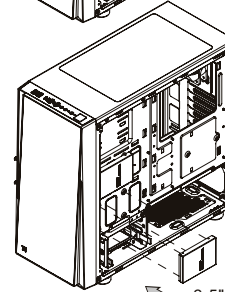
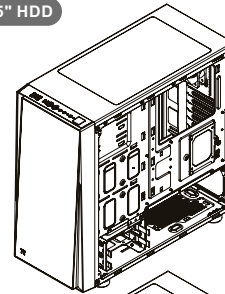

English /

Insert the HDD and tighten it with the screws.

Deutsch /

Führen Sie die Zoll HDD ein und befestigen Sie sie mit den Schrauben.

Français /

Insérez le disque dur de et sécurisez-le avec les vis.

Español /

Inserte el disco duro de y apriételo con los tornillos.

Italiano /

Inserire il dispositivo HDD da e fissarlo con le viti.

Português /

Insira o disco rígido de e aparafuse.

3.5" HDD

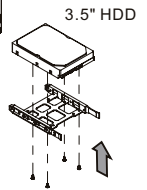
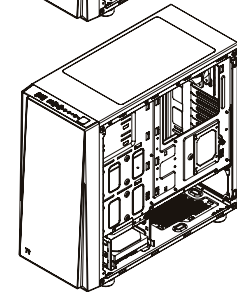
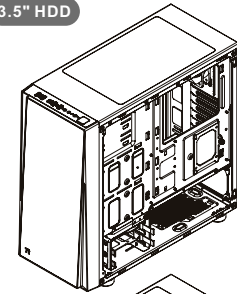

繁體中文 /

插入硬碟並用螺絲鎖上。

简体中文 /

插入硬盘并用螺丝锁上。

日本語 /

HDDを挿入し、ねじで締め付けます。

Русский /

Установите дюймовый жесткий диск и зафиксируйте его винтами.

Türkçe /

HDD'yi yerleştirin ve vidalarla sabitleyin.

ภาษาไทย /

ใส่ HDD ขนาด 3.5 นิ้ว เข้าไปแล้วขันสกรูยึดให้แน่น

PCI Slot Usage

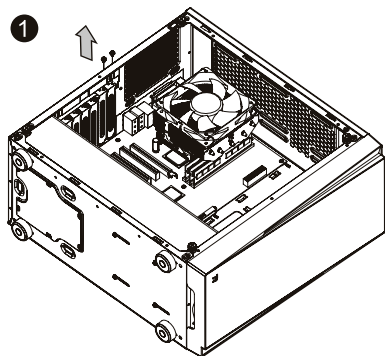

English /

1. Loosen the screws with a screwdriver.
2. Install the PCI card in proper location and secure it with screws.

Deutsch /

1. Lösen Sie die Schrauben mit einem Schraubendreher.
2. Installieren Sie die PCI-Card in der vorgesehenen Position und sichern Sie sie mit Schrauben.

Français /

1. Desserrez les vis à l'aide d'un tournevis.
2. Installez la carte PCI dans l'endroit approprié et fixez-la avec des vis.

Español /

1. Afloje los tornillos con un destornillador.
2. Instale la tarjeta PCI en la ubicación adecuada y asegúrela con tornillos.

Italiano /

1. Allentare le viti con un cacciavite.
2. Installare la scheda PCI nella posizione appropriata e fissarla con le viti.

Português /

1. Desaperte os parafusos com a chave de fendas.
2. Instale a placa PCI no local adequado e aparafuse.

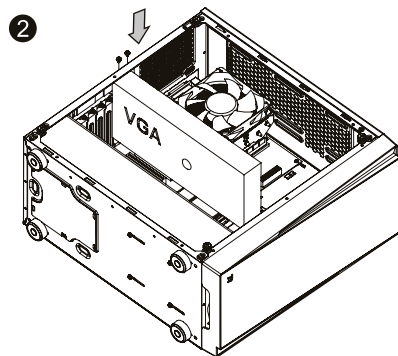

繁體中文 /

1. 用螺絲起子將螺絲取下。
2. 將擴充卡放置在合適的位置並用螺絲固定。

简体中文 /

1. 用螺丝起子将螺丝取下。
2. 将扩充卡放置在合适的位置并用螺丝固定。

日本語 /

1. ドライバーでねじを緩めます。
2. PCI カードを適切な場所に取り付け、ねじで固定します。

Русский /

1. Ослабьте винты отверткой.
2. Установите плату PCI в надлежащий разъем и закрепите ее винтами.

Türkçe /

1. Vidaları, bir tornavida ile gevşetin.
2. PCI kartını uygun konuma takın ve vidalarla sabitleyin.

ภาษาไทย /

1. ใช้ไขควงขันสกรูออก
2. ติดตั้งการ์ด PCI ในตำแหน่งที่เหมาะสมแล้วขันสกรูยึดให้แน่น

Radiator Installation

※The radiator is applicable up to 40mm high

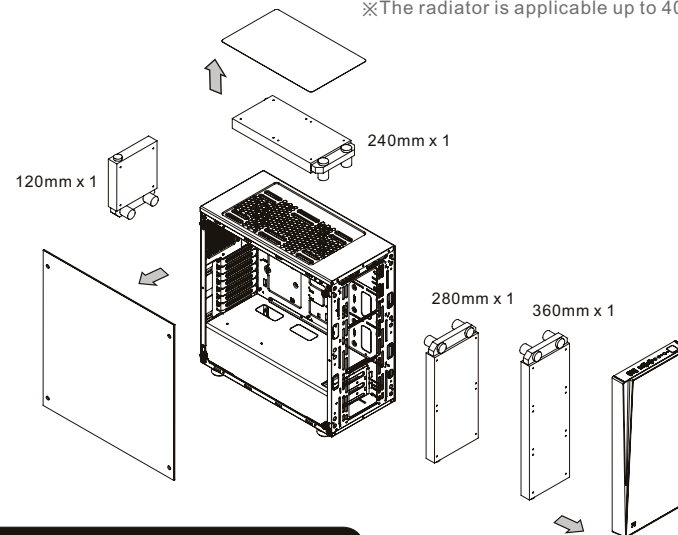

Air Cooling Installation

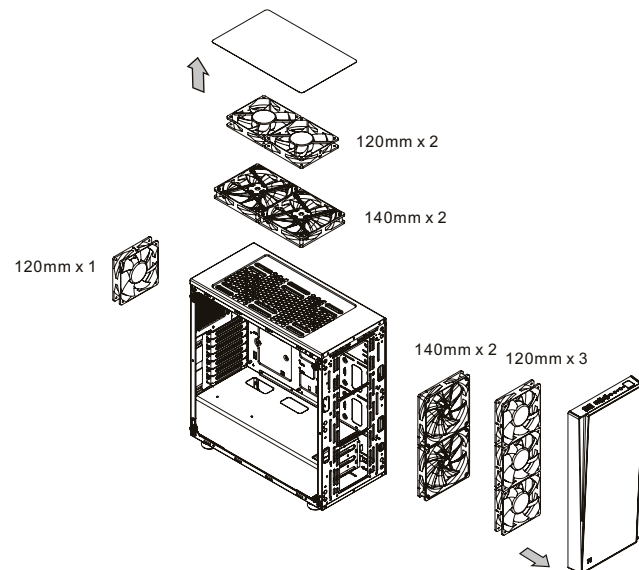

Leads Installation

English

Leads Installation Guide

Case LED Connection / On the front of the case, you can find some LEDs and switch leads. Please consult your user manual of your motherboard manufacturer, then connect these leads to the panel header on the motherboard.

USB 2.0 Connection / Please consult your motherboard manual to find out the section of "USB connection".

USB 3.0 connection /

1. Make sure your motherboard supports USB 3.0 connection.
2. Connect the USB 3.0 cable to the available USB 3.0 port on your computer.

Audio Connection / Please refer to the following illustration of Audio connector and your motherboard user manual. Please select the motherboard which used AC'97 or HD Audio(Azalia).(be aware of that your audio supports AC'97 or HD Audio (Azalia)) or it will damage your device(s).

Deutsch

Anschlüsse herstellen

Gehäuse-LED-Verbindungen / Auf der Gehäusevorderseite finden Sie einige LEDs und Verbindungen. Bitte nehmen Sie die Gebrauchsanweisung Ihres Motherboard Herstellers zur Hilfe und schließen Sie diese Verbindungen an die Panel Header Belegung des Motherboards an.

USB 2.0 Anschluss / Bitte nehmen Sie die Gebrauchsanweisung Ihres Motherboards zur Hilfe und lesen Sie unter dem Kapitel „USB Anschluss“ nach.

USB 3.0 Anschluss /

1. Stellen Sie sicher, dass Ihre Hauptplatine den USB 3.0 Anschluss unterstützt.
2. Verbinden Sie das USB 3.0 Kabel mit dem USB 3.0 Port auf Ihrem Computer.

Audio Anschlüsse / Bitte beachten Sie die folgende Abbildung der Audio Anschlüsse und die Anweisung in der Gebrauchsanweisung Ihres Motherboards. Bitte wählen Sie das Motherboard, das AC'97 oder HD Audio(Azalia) verwendet, (achten Sie darauf, dass Ihr Audio AC'97 bzw. HD Audio (Azalia unterstützt)). Andernfalls entstehen schwere Schäden an Ihrem(n) Gerät(en)!!!

AUDIO HD AUDIO Function

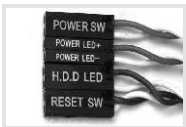
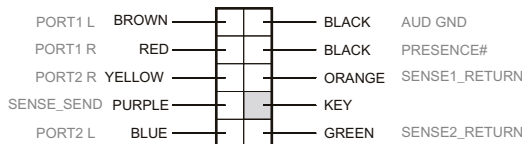

USB Function

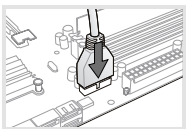
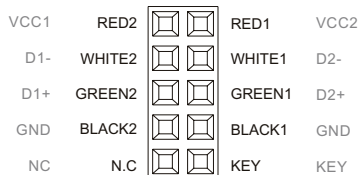

USB 3.0 Connection

Français

Guide d'installation des fils

Connexion des voyants du boîtier / Sur la face avant du boîtier, vous trouverez plusieurs voyants et les fils des boutons. S'il vous plaît consultez le guide d'utilisateur du fabricant de votre carte mère, puis connectez ces fils aux connecteurs sur la carte mère.

Connexion USB 2.0 / S'il vous plaît consultez le manuel de votre carte mère à la section "Connexion USB"

Connexion USB 3.0 /

1. Vérifiez que votre carte mère prend en charge la connexion USB 3.0.
2. Connectez le câble USB 3.0 au port USB 3.0 disponible sur votre ordinateur.

Connexion Audio / S'il vous plaît référez vous à l'illustration suivante du connecteur audio et au guide de l'utilisateur de votre carte mère. S'il vous plaît sélectionnez une carte mère supportant AC'97 ou HD Audi (Azalia), (faites attention que votre audio supporte l'AC'97 ou HD Audio (Azalia)) sinon cela pourrait endommager votre matériel.

Español

Guía de Instalación de Cables

Conexión del LED de la caja / En la parte frontal de la caja, encontrará algunos LED y cables de interruptores. Consulte el manual del usuario del fabricante de la placa madre, a continuación conecte estos cables al conector de la placa madre.

Conexión USB 2.0 / Consulte el manual de la placa madre para obtener más información sobre el apartado "Conexión USB"

Conexión USB 3.0 /

1. Asegúrese de que la placa base admite conexión USB 3.0.
2. Conecte el cable USB 3.0 al puerto USB 3.0 disponible en el equipo.

Conexión de Audio / Consulte la siguiente ilustración del conector de Audio y el manual del usuario de la placa madre. Seleccione la placa madre que utiliza AC'97 o HD Audio (Azalia), (asegúrese de que su audio admite AC'97 o HD Audio (Azalia)) si no, sus dispositivos resultarán dañados

AUDIO HD AUDIO Function

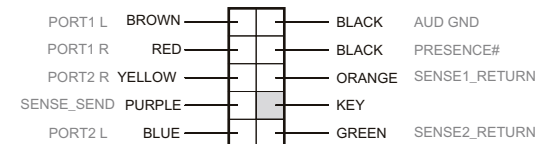

USB Function

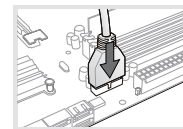
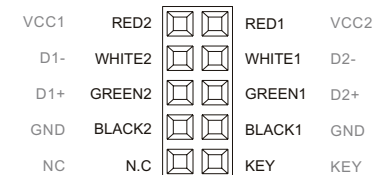

USB 3.0 Connection

Italiano

Guida di installazione dei contatti

Connessione del LED del case / Nella parte anteriore del case, sono presenti alcuni contatti per interruttori e LED. Consultare il manuale utente del produttore della scheda madre, quindi connettere i contatti alla parte superiore del pannello sulla scheda madre.

Connessione USB 2.0 / Consultare il manuale per la scheda madre che comprende la sezione relative alla "connessione USB".

Connessione USB 3.0 /

1. Accertarsi che la scheda madre supporti la connessione USB 3.0.
2. Collegare il cavo USB 3.0 alla porta USB 3.0 disponibile sul computer.

Connessione Audio / Fare riferimento all'illustrazione riportata di seguito del connettore Audio e al manuale utente per la scheda madre. Selezionare la scheda madre relativa a AC'97 o HD Audio (Azalia) e considerare che il supporto audio è compatibile con AC'97 o HD Audio (Azalia); in caso contrario, le periferiche potrebbero venire danneggiate.

Português

Guia de Instalação Eléctrica

Ligação do LED da Caixa / Na parte dianteira da caixa pode encontrar alguns LEDs e fios eléctricos. Consulte o manual de utilizador do fabricante da sua motherboard e ligue os fios à parte superior do painel na motherboard.

Ligação USB 2.0 / Consulte o manual da sua motherboard para ver a secção de "Ligação USB".

Ligação USB 3.0 /

1. Certifique-se que a sua motherboard suporta ligação USB 3.0.
2. Ligue o cabo USB 3.0 à porta USB 3.0 disponível no seu computador.

Ligação Audio / Consulte a imagem seguinte do conector Audio e o manual de utilizador da sua motherboard. Selecione a motherboard que utiliza AC'97 ou HD Áudio (Azalia), (verifique se a sua placa de áudio suporta AC'97 ou HD Áudio (Azalia)) ou irá danificar o(s) seu(s) dispositivo(s).

AUDIO HD AUDIO Function

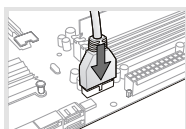
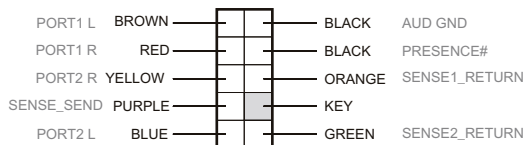

USB 3.0 Connection

USB Function

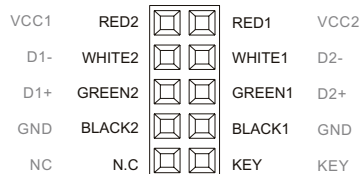

繁體中文

線材安裝說明

機殼LED連接方式 / 在機殼前方的面板後面，可以找到一些LED與開關線材 (POWER Switch....)，請參考主機板使用說明書，並將機殼上的線材正確地連接到主機板上，這些線材通常都會印有標籤在上面，如果沒有的話，請找出機殼前方面板上線材原本的位置以知道正確的來源。

USB 2.0 連接 / 請參考主機板使用手冊找出主機板上的USB連接孔位

USB 3.0 連接 /

1. 請確認主機板是否支援USB 3.0傳輸介面。
 2. 連接USB 3.0傳輸線至主機板上的USB3.0接埠。
- 音效連接** / 請根據下面的音源接頭圖示與主機板使用手冊來連接音效裝置，請確認主機板上的音效裝置是支援AC'97音效或是HD音效(Azalia)，裝置錯誤可能會導致主機板音效裝置的毀損，某些主機板的音效裝置不會與下方的圖示完全相同，請參酌主機板使用手冊以得到正確的安裝資訊

简体中文

线材安装说明

机壳LED连接方式 / 在机壳前方的面板后面，可以找到一些LED与开关线材 (POWER Switch....)，请参考主板使用说明书，并将机壳上的线材正确地连接到主板上，这些线材通常都会印有标签在上面，如果没有的话，请找出机壳前方面板上线材原本的位置以知道正确的来源。

USB 2.0 连接 / 请参考主板使用手册找出主板上的USB连接孔位

USB 3.0 连接 /

1. 请确认主板是否支持USB 3.0传输接口。
2. 连接USB 3.0传输线至主板上的USB3.0接埠。

音效连接 / 请根据下面的音源接头图示与主板使用手册来连接音效装置，请确认主板上的音效装置是支持AC'97音效或是HD音效(Azalia)，装置错误可能会导致主板音效装置的毁损，某些主板的音效装置不会与下方的图标完全相同，请参酌主板使用手册以得到正确的安装信息

AUDIO HD AUDIO Function

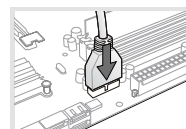
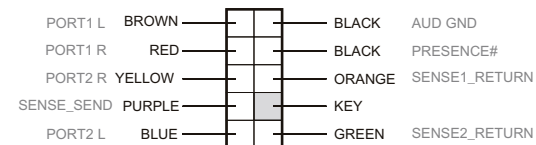

USB 3.0 Connection

USB Function

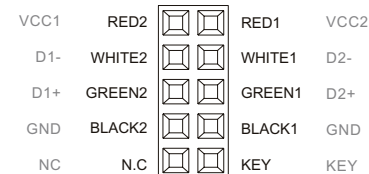

日本語

リード線の取り付けガイド

ケース LED の接続 / ケース前面には、LEDとスイッチリード線があります。 マザーボードメーカーのユーザーマニュアルを参照し、これらのリード線をマザーボードのパネルヘッダに接続してください。

USB 2.0 の接続 / マザーボードのマニュアルを参照して、「USB接続」のセクションを探します。

USB 3.0 の接続 /

1. お使いのマザーボードがUSB 3.0接続をサポートしていることを確認してください。
2. USB 3.0ケーブルをコンピュータの空いているUSB 3.0ポートに接続します。

オーディオ接続 / オーディオコネクタの次の図とマザーボードのユーザーマニュアルを参照してください。AC'97またはHDオーディオ(Azalia)を使用するマザーボードを選択してください(オーディオがAC'97またはHDオーディオ(Azalia)をサポートしていることを確認してください)。サポートしていないと、デバイスが損傷します。

Русский

Указания по прокладке кабелей

Подключение индикаторов корпуса / В передней части корпуса расположены индикаторы и провода выключателей. Перед подсоединением этих проводов к монтажной колодке панели на материнской плате изучите руководство пользователя производителя материнской платы.

Подключение USB 2.0 / См. раздел «Подключение USB» в руководстве материнской платы.
Подключение USB 3.0 /

1. Убедитесь, что материнская плата поддерживает подключение по стандарту USB 3.0.
2. Подсоедините кабель USB 3.0 к свободному порту USB 3.0 компьютера.

Подключение аудиоразъема / См. следующую иллюстрацию аудиоразъема и руководство пользователя материнской платы. Выберите материнскую плату, в которой используется кодек AC'97 или HD Audio (Azalia) (убедитесь, что звуковая плата поддерживает кодек AC'97 или HD Audio (Azalia)). В противном случае можно повредить устройства.

AUDIO HD AUDIO Function

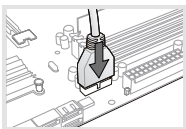
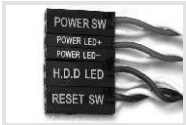
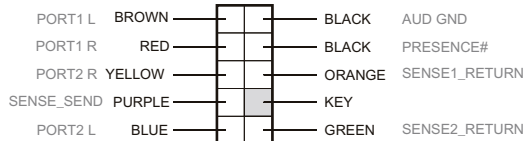

USB 3.0 Connection

USB Function

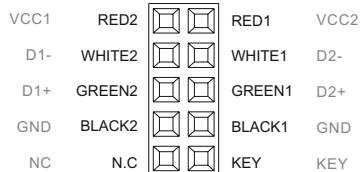

Türkçe

Ara Kablo Kurulum Kılavuzu

Kasa ışık bağlantısı / Kasanın ön kısmında bazı ışıklar ve anahtar ara kabloları görebilirsiniz. Lütfen anakart üreticinizin sağladığı kullanım kılavuzuna bakın ve daha sonra, bu ara kabloları, anakart üzerindeki panel bağlantı noktalarına bağlayın. USB 2.0 bağlantısı / Lütfen anakart kılavuzunuzun "USB bağlantısı" bölümüne bakın.

USB 3.0 Bağlantısı /

1. Ana kartınızın USB 3.0 bağlantısını desteklediğinden emin olun.
2. USB 3.0 kablосunu, bilgisayarınızdaki kullanılabilir USB 3.0 bağlantı noktasına bağlayın.

Ses Bağlantısı / Lütfen aşağıdaki Ses konektörü resmine ve anakartınızın kullanım kılavuzuna bakın. Lütfen AC'97 veya HD Audio (Azalia) spesifikasyonunu kullanan bir anakart seçin (ses sisteminizin AC'97 veya HD Audio (Azalia) spesifikasyonunu desteklediğini unutmayın); aksi takdirde, aygıt(lar)ınız zarar görür.

ภาษาไทย

คู่มือการติดตั้งสายไฟ

การเชื่อมต่อไฟ LED ของเคส / ที่ด้านหน้าของเคส คุณจะเห็นไฟ LED และสายไฟของสวิตช์

กรุณาศึกษารายละเอียดจากคู่มือผู้ใช้ของผู้ผลิตแผงวงจรหลักของคุณ จากนั้นให้เชื่อมต่อสายไฟเหล่านี้เข้ากับส่วนหัวของแผงบนแผงวงจรหลัก

การเชื่อมต่อ USB 2.0 / กรุณาศึกษารายละเอียดจากคู่มือผู้ใช้ของผู้ผลิตแผงวงจรหลักของคุณ ในหัวข้อ "การเชื่อมต่อ USB"

การเชื่อมต่อ USB 3.0 /

1. ตรวจสอบให้แน่ใจว่าแผงวงจรหลักของคุณรองรับการเชื่อมต่อ USB 3.0
2. เชื่อมต่อสาย USB 3.0 เข้ากับพอร์ต USB 3.0 ที่สามารถใช้งานได้บนคอมพิวเตอร์ของคุณ การเชื่อมต่ออุปกรณ์รับส่งสัญญาณเสียง/ กรุณาตรวจสอบรายละเอียดจากภาพประกอบของตัวเชื่อมต่อสัญญาณเสียงต่อไปนี้ และคู่มือผู้ใช้ของผู้ผลิตแผงวงจรหลักของคุณ กรุณาเลือกแผงวงจรหลักที่ใช้ AC'97 หรือ HD Audio (Azalia) (กรุณาตรวจสอบให้แน่ใจว่าอุปกรณ์รับส่งสัญญาณเสียงของคุณรองรับ AC'97 หรือ HD Audio (Azalia)) มิฉะนั้นอุปกรณ์ของคุณอาจเสียหายได้

AUDIO HD AUDIO Function

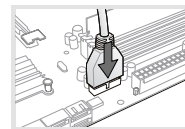
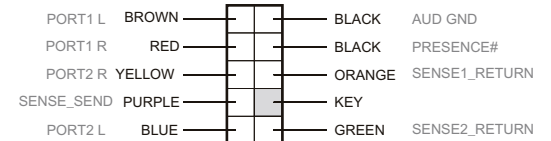

USB 3.0 Connection

USB Function

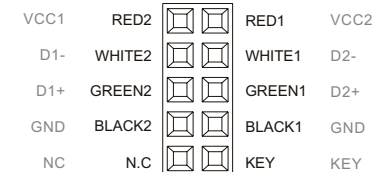

Thermaltake Power Supply Series (Optional)



As today's technology updates rapidly, consumers are always requesting for higher and higher PC performance, which also increases loads to power supplies. Therefore, selecting a suitable and reliable power supply becomes a necessary lesson for all PC users.

Why Choose Thermaltake Power Supply?

Quality From Within

Every power supply units from Thermaltake should pass a very strict quality control before sent to customers, including BIT(Burn-in-test) for over 8 continuous hour in a 45°C room to test if a unit can run normally under usual scene, and Hipot test to ensure the power supply unit can survive and protect both users and their systems when the voltage volume surges.

Less is more

In order to prevent wasted energy, all of Thermaltake's products should have at least 80% of transforming efficiency, and we're also one of the manufacturers that have the most 80 PLUS certificates. Because Thermaltake knows how to save for the earth and customers; we know what makes less to be more.

Being Supportive By All Means

A product with better quality can have longer life and working hours but less pollution. Thermaltake obeys and respects all environmental clauses in all countries and make sure all of our products are both user and environmental-friendly. Therefore we show our supports by giving 2 to 7-year warranties, which is not only a quality commitment to the users, but also love to this planet by reducing resources and wastes.



Thermaltake has several power supply product lines; please refer to our official website and Facebook Fan Page for more detail information!

Brand official website:

<http://www.thermaltake.com/>

Global Facebook :

<https://www.facebook.com/ThermaltakeInc>

Taiwan Facebook

<https://www.facebook.com/ThermaltakeTW>

Ovaj dokument je originalno proizveden i objavljen od strane proizvođača, brenda Thermaltake, i preuzet je sa njihove zvanične stranice. S obzirom na ovu činjenicu, Tehnoteka ističe da ne preuzima odgovornost za tačnost, celovitost ili pouzdanost informacija, podataka, mišljenja, saveta ili izjava sadržanih u ovom dokumentu.

Napominjemo da Tehnoteka nema ovlašćenje da izvrši bilo kakve izmene ili dopune na ovom dokumentu, stoga nismo odgovorni za eventualne greške, propuste ili netačnosti koje se mogu naći unutar njega. Tehnoteka ne odgovara za štetu nanесenu korisnicima pri upotrebi netačnih podataka. Ukoliko imate dodatna pitanja o proizvodu, ljubazno vas molimo da kontaktirate direktno proizvođača kako biste dobili sve detaljne informacije.

Za najnovije informacije o ceni, dostupnim akcijama i tehničkim karakteristikama proizvoda koji se pominje u ovom dokumentu, molimo posetite našu stranicu klikom na sledeći link:

<https://tehnoteka.rs/p/thermaltake-kuciste-versa-j21-akcija-cena/>