

Uputstvo za upotrebu (EN)

LG UltraGear monitor 34GP950G-B



Tehnoteka je online destinacija za upoređivanje cena i karakteristika bele tehnike, potrošačke elektronike i IT uređaja kod trgovinskih lanaca i internet prodavnica u Srbiji. Naša stranica vam omogućava da istražite najnovije informacije, detaljne karakteristike i konkurentne cene proizvoda.

Posetite nas i uživajte u ekskluzivnom iskustvu pametne kupovine klikom na link:

<https://tehnoteka.rs/p/lg-ultragear-monitor-34gp950g-b-akcija-cena/>



Owner's Manual

LG UltraGear™

Gaming Monitor

(LED Monitor*)

* LG LED Monitor applies LCD screen with LED backlights.

Please read this manual carefully before operating your set and retain it for future reference.

34GP950G

www.lg.com

Copyright © 2021 LG Electronics Inc. All Rights Reserved.

TABLE OF CONTENTS

LICENSE	3
OPEN SOURCE SOFTWARE NOTICE INFORMATION	4
ASSEMBLING AND PREPARING	4
USING THE MONITOR.....	14
USER SETTINGS	16
TROUBLESHOOTING	22
PRODUCT SPECIFICATION.....	24

LICENSE

Each model has different licenses. Visit www.lg.com for more information on the license.



The terms HDMI, HDMI High-Definition Multimedia Interface, and the HDMI Logo are trademarks or registered trademarks of HDMI Licensing Administrator, Inc.



The SuperSpeed USB Trident logo is a registered trademark of USB Implementers Forum, Inc.



© 2019 NVIDIA, the NVIDIA logo, and NVIDIA® G-SYNC® ULTIMATE are trademarks and/or registered trademarks of NVIDIA Corporation in the U.S. and other countries.



VESA, VESA logo, DisplayPort compliance logo and DisplayPort compliance logo for dual-mode source devices are all registered trademarks of the Video Electronics Standards Association.

OPEN SOURCE SOFTWARE NOTICE INFORMATION

To obtain the source code under GPL, LGPL, MPL, and other open source licenses, that is contained in this product, please visit <http://opensource.lge.com>. In addition to the source code, all referred license terms, warranty disclaimers and copyright notices are available for download. LG Electronics will also provide open source code to you on CD-ROM for a charge covering the cost of performing such distribution (such as the cost of media, shipping, and handling) upon email request to opensource@lge.com. This offer is valid for a period of three years after our last shipment of this product. This offer is valid to anyone in receipt of this information.

ASSEMBLING AND PREPARING

CAUTION

- Always use genuine LG components to ensure safety and product performance.
- The product warranty will not cover damage or injury caused by the use of unauthorised components.
- It is recommended that use the supplied components.
- Illustrations in this document represent typical procedures, so they may look different from the actual product.
- Do not apply foreign substances (oils, lubricants, etc.) to the screw parts when assembling the product. (Doing so may damage the product.)
- Applying excessive force when tightening screws may cause damage to the monitor. Damage caused in this way will not be covered by the product warranty.
- Do not carry the monitor upside down by just holding the base. This may cause the monitor to fall off the stand and could result in personal injury.
- When lifting or moving the monitor, do not touch the monitor screen. The force applied to the monitor screen may cause damage to it.
- For wave pattern on appearance, unlike the general method of coating, it's applied to added glittering material in raw material. With no peeled-off appearance, it has good durability. Please use it with confidence because there is no problem in using the product at all.

NOTE

- The components may look different from those illustrated here.
- Without prior notice, all product information and specifications contained in this manual are subject to change to improve the performance of the product.
- To purchase optional accessories, visit an electronics store or an online shopping site, or contact the retailer from which you purchased the product.
- The power cord provided may differ depending upon the region.

Supported Drivers and Software

- You can download and install the latest version from the LGE website (www.lg.com).
 - Monitor Driver / OnScreen Control / LG UltraGear™ Control Center

Product and Button Description

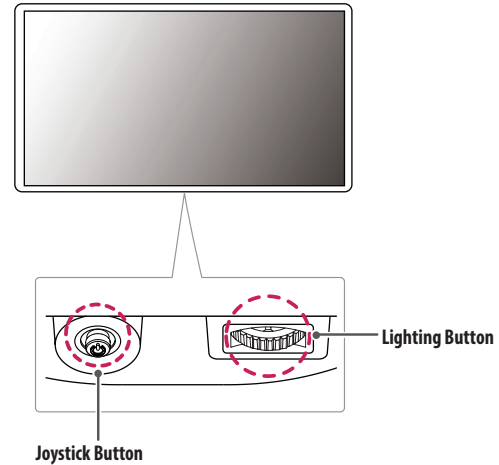

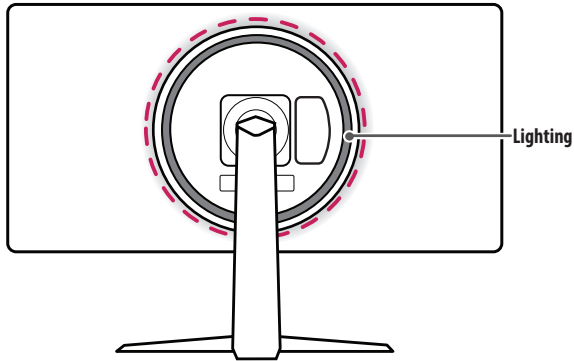

How to Use the Joystick Button

You can easily control the functions of the monitor by pressing the joystick button or moving it left/right/up/down with your finger.

Basic Functions

A	B	C	D

A (Power on): Press the joystick button once with your finger to turn on the monitor.

B (Power off): Press and hold the joystick button once more than 5 seconds with your finger to turn off the monitor.

C (Volume control): You can control the volume by moving the joystick button left/right.

D (Controls screen brightness): You can control the screen's brightness by moving the joystick button up/down. (for SDR only)

How to Use the Lighting Button

You can easily control the functions of the monitor by pressing the lighting button or moving it left/right with your finger.

Basic Functions

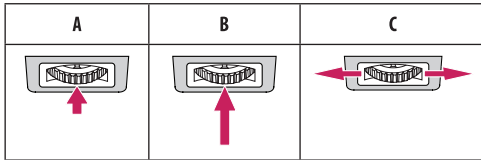

When Lighting is Off

A: Press the lighting button once with your finger to turn on the lighting on the back of the monitor.

B: Press and hold the lighting button once with your finger to turn on the lighting on the back of the monitor.

C: Not functional

When Lighting is On

A: You can adjust the color by press the lighting button.

B: Press and hold the lighting button once with your finger to turn off the lighting on the back of the monitor.

C: You can control the lighting brightness by moving the lighting button left/right.

! NOTE

- The joystick and lighting button are located at the bottom of the monitor.
- The Lighting function for the back of the monitor is available even when the monitor is in power saving mode or when its screen is off. ([Menu] > [General] > [Lighting Option] > [Keep Lighting Status])
- Lighting LED is not for illumination purposes. Please be aware that changes in this setting component may increase energy consumption of this monitor.

Moving and Lifting the Monitor

When moving or lifting the monitor, follow these instructions to prevent the monitor from being scratched or damaged and to ensure safe transportation, regardless of its shape or size.

- Place the monitor in the original box or packing material before attempting to move it.
- Before moving or lifting the monitor, disconnect the power cord and all other cables.
- Hold the bottom and side of the monitor frame firmly. Do not hold the panel itself.
- When holding the monitor, the screen should face away from you to prevent it from being scratched.
- When transporting the monitor, do not expose the monitor to shock or excessive vibration.
- When moving the monitor, keep it upright and never turn the monitor on its side or tilt it sideways.

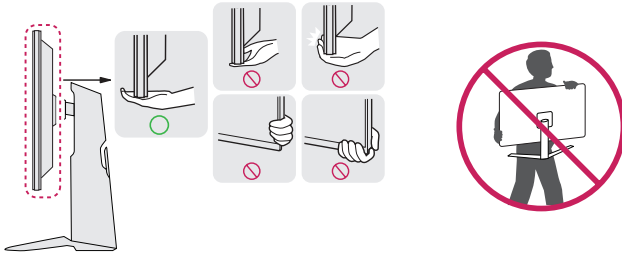

CAUTION

- Avoid touching the monitor screen as much as possible.
 - This may result in damage to the screen or some of the pixels used to create images.
- If you use the monitor panel without the stand base, its joystick button may cause the monitor to become unstable and fall, resulting in damage to the monitor or human injury. In addition, this may cause the joystick button to malfunction.

Installing on a Table

- Lift the monitor and place it on the table in an upright position. Place the monitor at least 100 mm away from the wall to ensure sufficient ventilation.

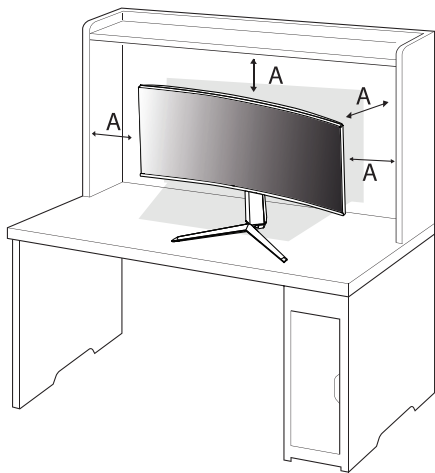

A: 100 mm

CAUTION

- Unplug the power cord before moving or installing the monitor. There is risk of electric shock.
- Make sure to use the power cord that is provided in the product package and connect it to a grounded power outlet.
- If you need another power cord, please contact your local dealer or the nearest retail store.

Adjusting the Stand Height

- 1 Place the monitor mounted on the stand base in an upright position.
- 2 Handle the monitor with both hands for safety.

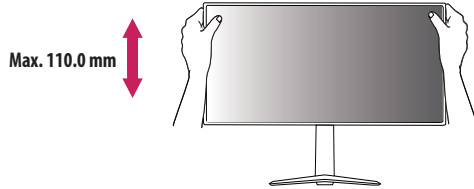

⚠ WARNING

- When adjusting the screen height, do not place your hand on the stand body to avoid injury to your fingers.

Adjusting the Angle

- 1 Place the monitor mounted on the stand base in an upright position.
- 2 Adjust the angle of the screen.

The angle of the screen can be adjusted forward or backward from -5° to 15° for a comfortable viewing experience.

⚠ WARNING

- To avoid injury to the fingers when adjusting the screen, do not hold the lower part of the monitor's frame as illustrated below.
- Be careful not to touch or press the screen area when adjusting the angle of the monitor.

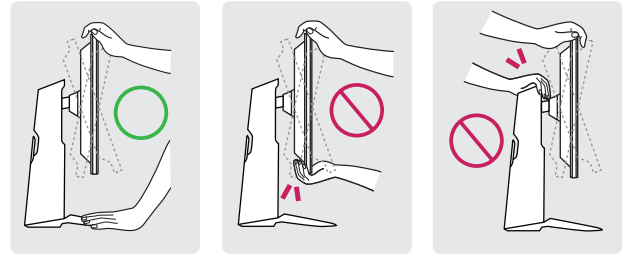

ⓘ NOTE

- The left or right side of the monitor head can be slightly rotated up or down (up to 3°). Adjust the horizontal level of the monitor head.

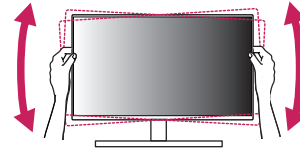

Using the Kensington Lock

For more information on installation and usage, refer to the Kensington lock owner's manual or visit the website at <http://www.kensington.com>.

Connect the monitor to a table using the Kensington security system cable.

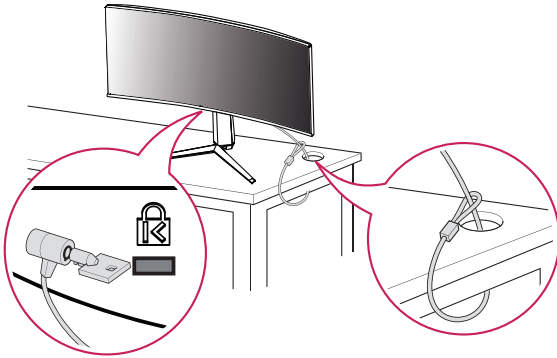

! NOTE

- The Kensington security system is optional. You can obtain optional accessories from most electronics stores.

Installing on the Wall

This monitor meets the specifications for the wall mount plate or other compatible devices.

Install the monitor at least 100 mm away from the wall and leave about 100 mm of space at each side of the monitor to ensure sufficient ventilation. Detailed installation instructions can be obtained from your local retail store. Alternatively, please refer to the manual for how to install and set up a tilting wall mounting bracket.

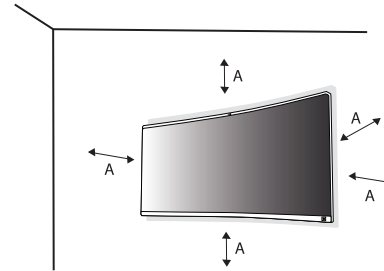

A: 100 mm

Installing the Wall Mount Plate

To install the monitor to a wall, attach a wall mounting bracket (optional) to the back of the monitor. Make sure that the wall mounting bracket is securely fixed to the monitor and to the wall.

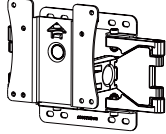
Wall Mount (mm)	100 x 100
Standard screw	M4 x L10
Number of screws	4
Wall Mount Plate (Optional)	LSW 149 

NOTE

- Use the screws specified by VESA standards.
- The wall mount kit includes the installation guide and all necessary parts.
- The wall mounting bracket is optional. You can obtain optional accessories from your local dealer.
- The length of the screw may differ for each wall mounting bracket. If you use screws longer than the standard length, it may damage the inside of the product.
- For more information, please refer to the user manual for the wall mounting bracket.
- Be careful not to apply too much force while mounting the wall mount plate as it may cause damage to the screen.
- Remove the stand before installing the monitor on a wall mount by performing the stand attachment in reverse.

⚠ CAUTION

- Unplug the power cord before moving or installing the monitor to avoid electric shock.
- Installing the monitor on the ceiling or on a slanted wall may result in the monitor falling off, which could lead to injury. Use an authorized LG wall mount and contact the local dealer or qualified personnel.
- To prevent injury, this apparatus must be securely attached to the wall in accordance with the installation instructions.
- Applying excessive force when tightening screws may cause damage to the monitor. Damage caused in this way will not be covered by the product warranty.
- Use the wall mounting bracket and screws that conform to VESA standards. Damage caused by the use or misuse of inappropriate components will not be covered by the product warranty.
- When measured from the back of the monitor, the length of each installed screw must be 8 mm or less.

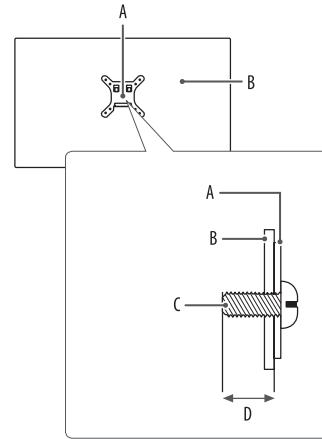

- A: Wall Mount Plate
- B: Back of the Monitor
- C: Standard screw
- D: Max. 8 mm

USING THE MONITOR

- Illustrations in this manual may differ from the actual product.
- Press the joystick button, go to [Menu] > [Input], and then select the input option.

CAUTION

- If you use generic cables not certified by LG, the screen may not display or there may be image noises.
- Do not press the screen for a prolonged time. This may cause image distortion.
- Do not display a still image on the screen for a prolonged time. This may cause image retention. Use a PC screensaver if possible.
- When connecting the power cord to the outlet, use a grounded (3-hole) power strip or a grounded power outlet.
- The monitor may flicker when turned on in an area where the temperature is low. This is normal.
- Sometimes red, green, or blue spots may appear on the screen. This is normal.

Connecting to a PC

- This monitor supports the Plug and Play* feature.
- * Plug and Play: A feature that allows you to add a device to your computer without having to reconfigure anything or install any manual drivers.

HDMI Connection

Transmits digital video and audio signals from your PC to the monitor.

CAUTION

- Using a DVI to HDMI / DP (DisplayPort) to HDMI cable may cause compatibility issues.
- Use a certified cable with the HDMI logo attached. If you do not use a certified HDMI cable, the screen may not display or a connection error may occur.
- Recommended HDMI cable types
 - High Speed HDMI®/™ cable
 - High Speed HDMI®/™ cable with Ethernet

DisplayPort Connection

Transmits digital video and audio signals from your PC to the monitor.

! NOTE

- There may be no video or audio output depending on the DP (DisplayPort) version of the PC.
- If you are using a Mini DisplayPort output graphics card, use a Mini DP to DP (Mini DisplayPort to DisplayPort) cable or gender that supports DisplayPort1.4. (Sold separately)

Connecting AV Devices

HDMI Connection

HDMI transmits digital video and audio signals from your AV device to the monitor.

! NOTE

- Using a DVI to HDMI / DP (DisplayPort) to HDMI cable may cause compatibility issues.
- Use a certified cable with the HDMI logo attached. If you do not use a certified HDMI cable, the screen may not display or a connection error may occur.
- Recommended HDMI cable types
 - High Speed HDMI[®]/TM cable
 - High Speed HDMI[®]/TM cable with Ethernet

Connecting Peripherals

USB Device connection

The USB port on the product functions as a USB hub.

To use USB 3.0, connect the A-B type USB 3.0 cable of the product to the PC.

Peripheral devices connected to the USB IN port can be controlled from the PC.

! NOTE

- It is recommended you install all Windows Updates to keep your Windows up-to-date before connecting to the product for use.
- Peripheral devices are sold separately.
- A keyboard, mouse, or USB device can be connected to the USB port.
- The charging speed may vary depending on the device.

⚠ CAUTION

- Cautions when using a USB device.
 - A USB device with an automatic recognition program installed, or that uses its own driver, may not be recognised.
 - Some USB devices may not be supported or may not work properly.
 - It is recommended to use a USB hub or hard disk drive with power supplied. (If the power supply is not adequate, the USB device may not be recognised properly.)

Connecting Headphones

Connect peripherals to the monitor via the headphones port.

! NOTE

- Peripheral devices are sold separately.
- Depending on the audio settings of the PC and external device, headphones and speaker functions may be limited.
- If you use angled earphones, it may cause a problem with connecting another external device to the monitor. Therefore, it is recommended to use straight earphones.



Angled



Straight
(Recommend)

SERVICE ONLY port

This port is used only for "Service".

The USB service port is not a supply for general USB power and which is under the control of manufacturer with service tool.

USER SETTINGS

! NOTE

- Your monitor's OSD (On Screen Display) may differ slightly from that shown in this manual.

Activating the Main Menu



Joystick Button

- 1 Press the joystick button on the bottom of the monitor.
- 2 Move the joystick up/down (▲/▼) and left/right (◀/▶) to set the options.
- 3 Press the joystick button once more to exit the main menu.

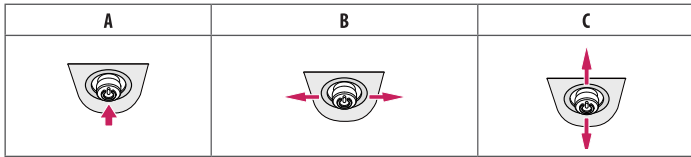

- A**
- Main menu disabled: Enables the main menu.
 - Main menu enabled: Enters the [Menu] feature. (Holding down the button more than 5 seconds to turn off the monitor. You can turn off the monitor this way at any time, including when the OSD is on.)
- B**
- Main menu disabled: Adjusts the monitor volume level. (◀, ▶)
 - Main menu enabled: Enters the [Input] features. (◀) / Enters the [Game Mode] feature. (▶) (for SDR only)
- C**
- Main menu disabled: Adjusts the monitor brightness level. (▲, ▼) (for SDR only)
 - Main menu enabled: Turns off the monitor. (▲) / Exits the main menu. (▼)

Main Menu Features

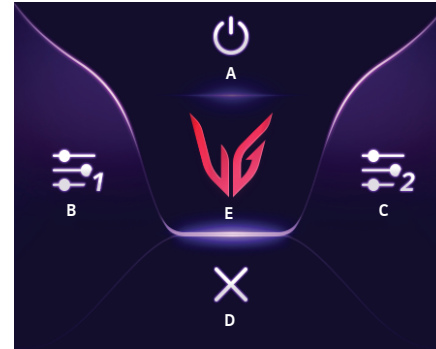

Main Menu	Description
A: [Power Off]	Turns off the monitor.
B: [Input]	Sets input mode. (Default) <ul style="list-style-type: none"> • You can customize the left (B) of the main menu to access your preferred menu easily. ([Menu] > [General] > [User-defined Key 1])
C: [Game Mode]	Sets the game mode for gaming. (Default) <ul style="list-style-type: none"> • You can customize the right (C) of the main menu to access your preferred menu easily. ([Menu] > [General] > [User-defined Key 2])
D: [Exit]	Exit the main menu.
E: [Menu]	Configures the screen settings.

Menu Settings

- 1 To view the OSD menu, press the joystick button at the bottom of the monitor and then enter the [Menu].
- 2 Move the joystick up/down and left/right to set the options.
- 3 To return to the upper menu or set other menu items, move the joystick to ◀ or pressing (⏪) it.
- 4 If you want to exit the OSD menu, move the joystick to ◀ until you exit.



[Game Mode]



[Game Adjust]



[Picture Adjust]



[Input]



[General]

[Game Mode]

[Menu] > [Game Mode]

! NOTE

[Game Mode] can not be selected when HDR is activated.

[Game Mode] on SDR(Non-HDR) signal

- [Gamer 1]/[Gamer 2]: [Gamer 1] and [Gamer 2] picture modes allow you to save two sets of customized display settings, including game-related setup options.
- [FPS]: This mode is optimised for FPS games. It is suitable for very dark FPS games.
- [RTS]: This mode is optimised for RTS Game.
- [Reader]: Optimises the screen for reading documents. You can brighten the screen in the OSD menu.
- [sRGB]: A standard RGB color space for the monitor and printer.

[Game Adjust]

[Menu] > [Game Adjust]

- [Overclock]
 - [On]: Sets Overclock to a higher refresh rate than specified by the panel specification.
 - [Off]: Disables the Overclock improvement feature.
- ! **NOTE**
- [Overclock]
 - After the monitor reboots, change the maximum refresh rate setting in the NVIDIA control panel.
 - If the screen display appears abnormal, turn off the Overclock setting.
 - The function can only be used through DisplayPort.
 - The Overclock function's features/performance may vary depending on the graphics card or gaming content.
 - We do not guarantee the performance of the function and are not responsible for any side effects that may occur from its activation.
- [Black Stabilizer] (for SDR only): You can control the black contrast to have better visibility in dark scenes. You can easily distinguish objects on dark game screens.
 - [High]: Sets the black stabilizer to High.
 - [Middle]: Sets the black stabilizer to Middle.
 - [Low]: Sets the black stabilizer to Low.
 - [Off]: Disables the feature.

- [Response Time]: Sets a response time for displayed pictures based on the speed of the screen. For a normal environment, it is recommended that you use [Fast]. For a fast-moving picture, it is recommended that you use [Faster]. Setting to [Faster] may cause image sticking.
 - [Faster]: Sets the response time to Faster.
 - [Fast]: Sets the response time to Fast.
 - [Normal]: Sets the response time to Normal.
 - [Off]: Disables the feature.
- [Crosshair]: Crosshair provides a mark on the center of the screen for First Person Shooter (FPS) games. Users can select the crosshair that fits their gaming environment among four different crosshairs.
- [FPS Counter]
 - [On]: The indicator is displayed on the upper left of the screen. It will reflect the actual frame rate that is received at the input.
 - [Off]: Disables the feature.

! NOTE

- [Crosshair] and [FPS Counter] feature can not used at the same time.

[Menu] > [Game Adjust] > [Game Reset]

- [Do you want to reset your Game settings?]
 - [No]: Cancel the select.
 - [Yes]: Returns to the default settings.

[Picture Adjust]

[Menu] > [Picture Adjust]

- [Brightness/Contrast] (for SDR only): Adjusts the brightness and color contrast of the screen.
- [Gamma] (for SDR only)
 - [Mode 1], [Mode 2], [Mode 3]: The higher the gamma value, the darker the image becomes. Likewise, the lower the gamma value, the lighter the image becomes.
- [Color Temp] (for SDR only): Set your own color temperature.
 - [Custom]: The user can customize the red, green and blue color.
 - [Warm]: Sets the screen color to a reddish tone.
 - [Medium]: Sets the screen color to between a red and blue tone.
 - [Cool]: Sets the screen color to a bluish tone.
- [R/G/B] (for SDR only): You can customize the picture color using red, green, and blue colors.
- [Six Color] (for SDR only): Meets the user requirements for colors by adjusting the saturation of the six colors (red, green, blue, cyan, magenta, and yellow) and then saving the settings.
 - Saturation: Adjusts the saturation of the screen colors. The lower the value, the less saturated and brighter the colors become. The higher the value, the more saturated and darker the colors become.
- [Local Dimming]: Maximises the contrast ratio by making the bright areas of the screen brighter and the dark areas of the screen darker. Turning this option off may increase energy consumption.
 - [Aggressive]: Sets the local dimming to aggressive.
 - [Normal]: Sets the local dimming to normal.
 - [Smooth]: Sets the local dimming to smooth.
 - [Off]: Disables the feature.

[Menu] > [Picture Adjust] > [Picture Reset]

- [Do you want to reset your Picture settings?]
 - [No]: Cancel the select.
 - [Yes]: Returns to the default settings.

[Input]

[Menu] > [Input]

- [Input List]: Selects the input mode.
- [Aspect Ratio]: Adjusts the aspect ratio of the screen.

The display may look the same for [Full Wide] and [Original] options at the recommended resolution.

 - [Full Wide]: Displays the video in widescreen, regardless of the video signal input.
 - [Original]: Displays video according to the aspect ratio of the video signal input.
- [Auto Input Switch]: When [Auto Input Switch] is set to [On], display will automatically switch to new input when connected.

[General]

[Menu] > [General]

- [Language]: Sets the menu screen to the desired language.
- [User-defined Key 1]/[User-defined Key 2]: You can customize the main menu to access your preferred menu easily. [User-defined Key 1] and [User-defined Key 2] appear at the left/right of the main menu.
- [Power LED]

When the Power LED function is turned on, it operates as follows:

- On Mode: Light up
- Sleep Mode (Standby Mode): Blinking
- Off Mode: Off
- [Lighting Option]: When turning off the monitor, You can set a [Keep Lighting Status] or [Turn Off Lighting].
 - [Keep Lighting Status]: When the monitor turn off, the lighting on the back of the monitor is always on.
 - [Turn Off Lighting]: When the monitor turn off, the lighting on the back of the monitor turn off. When the monitor turn on, the last selected lighting status turn on.

- [Automatic Standby]: If there is no operation on the monitor for a certain period of time, the monitor will automatically switch to standby mode.
- [Buzzer]: This feature lets you set the sound generated from Buzzer when your monitor powers on.
- [OSD Lock]: This feature disables the configuration and adjustment of menus.
All features are disabled except [Brightness/Contrast] in [Picture Adjust], [Input List] in [Input], [OSD Lock] and [Information] in [General].
- [Deep Sleep]: This feature turns the monitor off when there is no signal detected from the HDMI or DisplayPort input after approximately 13 minutes.
 - [On]: Enables [Deep Sleep].
 - [Off]: Disables the feature.
- [Information]: The following display information will be shown; the Model, Total power on time, Resolution, Mode, Input, Format, Range and EOTF.

[Menu] > [General] > [Reset to Initial Settings]

- [Do you want to reset your settings?]
 - [No]: Cancel the reset.
 - [Yes]: Returns to the default settings.

TROUBLESHOOTING

Nothing is displayed on the screen.

- Is the monitor's power cord plugged in?
 - Check if the power cord is correctly plugged into the power outlet.
- Is the monitor's adapter plugged in?
 - Make sure to use the adapter that is provided in the product package.
- Is the power LED on?
 - Check the power cable connection and press the power button.
- Is the power on and the power LED displaying red?
 - Check that the connected input is enabled ([Menu] > [Input]).
- Is the power LED blinking?
 - If the monitor is in sleep mode, move the mouse, or press any key on the keyboard, to switch the display on.
 - Check if the computer is turned on.
- Is the [The screen is not currently set to the recommended resolution. If you have no video or the screen flickers, see the troubleshooting guide in the product owner's manual.] message being displayed?
 - This occurs when signals transferred from the PC (graphics card) are out of the recommended horizontal or vertical frequency range of the monitor. Please see the Product Specification section of this manual to set the appropriate frequency.

- Is the [No Signal] message being displayed?
 - This is displayed when the signal cable between the PC and the monitor is missing or disconnected. Check the cable and reconnect it.
- Is the [Out of Range] message being displayed?
 - This occurs when signals transferred from the PC (graphics card) are out of the horizontal or vertical frequency range of the monitor. Please see the Product Specification section of this manual to set the appropriate frequency.

Some features are disabled.

- Are some functions not available when you press the Menu button?
 - The OSD is locked. Disable [OSD Lock] in [General].
 - Check the PC settings and input signal. (HDR, No Signal)

Do you see an "Unrecognised monitor, Plug and Play (VESA DDC) monitor found" message?

- Have you installed the display driver?
 - Be sure to install the display driver from our web site: <http://www.lg.com>.
 - Make sure to check if the graphics card supports Plug and Play function.

The screen retains an image.

- Does image sticking occur even when the monitor is turned off?
 - Displaying a still image for a prolonged time may cause damage to the screen, resulting in the retention of the image.
 - To extend the lifetime of the monitor, use a screensaver.
- Are there spots on the screen?
 - When using the monitor, pixilated spots (red, green, blue, white, or black) may appear on the screen. This is normal for an LCD screen. It is not an error, nor is it related to the monitor's performance.

Screen display is unstable and shaky. / Images displayed on the monitor leave shadow trails.

- Did you select the appropriate resolution?
 - If the selected resolution is HDMI 1080i 60/50 Hz (interlaced), the screen may be flickering. Change the resolution to 1080p or the recommended resolution.

! NOTE

- Not setting the graphics card to the recommended (optimal) resolution may result in blurred text, a dimmed screen, a truncated display area or misalignment of the display.
- The setting methods may be different depending on the computer or operating system, and some resolutions may not be available depending on the performance of the graphics card. If this is the case, contact the manufacturer of the computer or graphics card for assistance.

No sound from the headphone port.

- Are images displayed using DisplayPort or HDMI input without sound?
 - Make sure that the headphone port connections are made properly.
 - Try increasing the volume with the joystick.
 - Set the audio output of the PC to the monitor you are using. (The settings may differ depending on the operating system (OS) you use.)

The Lighting on the back of the monitor does not turn on.

- Is the monitor's power cord plugged in?
 - Check if the power cord is correctly plugged into the power outlet.
- Is the monitor's adapter plugged in?
 - Make sure to use the adapter that is provided in the product package.
- Did you press the Lighting Button?
 - Press the Lighting Button located at the bottom of the monitor.

PRODUCT SPECIFICATION

Specifications are subject to change without notice.

The symbol ~ means alternating current, and the symbol — means direct current.

Color Depth: 8 bit / 10-bit color is supported.

Resolution

- Max Resolution:
 - 3440 x 1440 @ 100 Hz (HDMI)
 - 3440 x 1440 @ 180 Hz (DisplayPort) ([Overclock]: [On])
- Recommended Resolution:
 - 3440 x 1440 @ 100 Hz (HDMI)
 - 3440 x 1440 @ 144 Hz (DisplayPort)

AC/DC Adapter

- Model: A16-140P1A
 Manufacturer: CHICONY POWER TECHNOLOGY
 - Input: 100-240V~ 50-60 Hz 2.0 A
 - Output: 19V — 7.37 A
- Model: ADS-150KL-19N-3 190140E
 Manufacturer: SHENZHEN HONOR ELECTRONIC
 - Input: 100-240V~ 50/60 Hz 2.0 A
 - Output: 19V — 7.37 A

Environmental Conditions

- Operating Conditions
 - Temperature: 0 °C to 40 °C
 - Humidity: Less than 80 %
- Storing Conditions
 - Temperature: -20 °C to 60 °C
 - Humidity: Less than 85 %

Dimensions: Monitor Size (Width x Depth x Height)

- With Stand (mm): 816.2 x 312.2 x 579.8
- Without Stand (mm): 816.2 x 108.1 x 361.4

Weight (Without Packaging)

- With Stand (kg): 9.1
- Without Stand (kg): 7.0

Power Sources

- Power Rating: 19V — 5.5 A
- Power Consumption
 - Operating Mode: 65 W (Typical)*
 - Sleep Mode (Standby Mode): ≤ 0.3 W ([Deep Sleep]: [On])
 - Off Mode: ≤ 0.3 W

* The Operating Mode of Power Consumption is measured with LGE test standard. (Full White pattern, Maximum resolution, Outgoing condition)

* The Power Consumption level can be different by operating condition and monitor setting.

Supported Mode

(Preset Mode, HDMI/DisplayPort)

Resolution	Horizontal Frequency (kHz)	Vertical Frequency (Hz)	Polarity (H/V)	Remarks
640 x 480	31.469	59.94	-/-	
800 x 600	37.879	60.317	+/+	
1024 x 768	48.363	60.0	-/-	
2560 x 1440	183.00	120.0	+/-	HDMI only
3440 x 1440	74.29	49.99	+/-	HDMI only
3440 x 1440	89.44	59.99	+/-	
3440 x 1440	127.83	85.00	+/-	HDMI only
3440 x 1440	150.97	99.98	+/-	Recommended (HDMI)
3440 x 1440	182.99	119.99	+/-	DisplayPort only
3440 x 1440	222.15	143.97	+/-	Recommended (DisplayPort) DisplayPort only
3440 x 1440	248.75	159.97	+/-	DisplayPort only ([Overclock]: [On])
3440 x 1440	282.57	179.98	+/-	DisplayPort only ([Overclock]: [On])

HDMI Timing (Video)

Resolution	Horizontal Frequency (kHz)	Vertical Frequency (Hz)	Remarks
480P	31.5	60	
576P	31.25	50	
720P	37.5	50	
720P	45	60	
1080P	56.25	50	
1080P	67.5	60	
1080P	135	120	

HDR Monitor

- The monitor supports HDR function, when detecting HDR content, an 'HDR' message will pop up in the upper right corner of the monitor. The HDR status will be displayed as [On] in the monitor OSD menu.
- HDR content may not be operated properly depending on the Windows 10 OS settings. Please check HDR On/Off setting of Windows.
- When the HDR function is turned on, the characters or picture quality may be poor according to graphic card performance.

G-SYNC Monitor

- The monitor is purposely supporting the NVIDIA's G-SYNC technology and targeting NVIDIA GPU.
- Requirement for using G-SYNC
 - Supported Interface: DisplayPort (System must support DisplayPort 1.4 directly from the GPU.)
 - Supported Graphic Card: A graphic card that supports NVIDIA's G-SYNC is necessary. (NVIDIA Pascal GPU Graphics Card like GTX 1070, GTX 1080 or higher.)
 - Supported Version: Make sure to update the graphic card to the latest driver.
 - Supported OS: Windows 10 64 bit
- This monitor supports '**Adaptive Sync**' on DisplayPort and HDMI-VRR on HDMI. (for Xbox One VRR)
- For more information and requirement, refer to NVIDIA website at <http://www.geforce.com/hardware/technology/g-sync>.



The model and serial number of the product are located on the back and on one side of the product.
Record them below in case you ever need service.

Model _____

Serial No. _____

Ovaj dokument je originalno proizveden i objavljen od strane proizvođača, brenda LG, i preuzet je sa njihove zvanične stranice. S obzirom na ovu činjenicu, Tehnoteka ističe da ne preuzima odgovornost za tačnost, celovitost ili pouzdanost informacija, podataka, mišljenja, saveta ili izjava sadržanih u ovom dokumentu.

Napominjemo da Tehnoteka nema ovlašćenje da izvrši bilo kakve izmene ili dopune na ovom dokumentu, stoga nismo odgovorni za eventualne greške, propuste ili netačnosti koje se mogu naći unutar njega. Tehnoteka ne odgovara za štetu nanесenu korisnicima pri upotrebi netačnih podataka. Ukoliko imate dodatna pitanja o proizvodu, ljubazno vas molimo da kontaktirate direktno proizvođača kako biste dobili sve detaljne informacije.

Za najnovije informacije o ceni, dostupnim akcijama i tehničkim karakteristikama proizvoda koji se pominje u ovom dokumentu, molimo posetite našu stranicu klikom na sledeći link:

<https://tehnoteka.rs/p/lg-ultragear-monitor-34gp950g-b-akcija-cena/>