

Uputstvo za upotrebu

ARISTON bojler VELIS EVO 50 EU



Tehnoteka je online destinacija za upoređivanje cena i karakteristika bele tehnike, potrošačke elektronike i IT uređaja kod trgovinskih lanaca i internet prodavnica u Srbiji. Naša stranica vam omogućava da istražite najnovije informacije, detaljne karakteristike i konkurentne cene proizvoda.

Posetite nas i uživajte u ekskluzivnom iskustvu pametne kupovine klikom na link:

<https://tehnoteka.rs/p/ariston-bojler-velis-evo-50-eu-akcija-cena/>

1. ACCESSORI. 2. APPROCCIO ALL'INSTALLAZIONE. 3. POSIZIONAMENTO DELL'APPARECCHIO. 4. UTILIZZO DELLA DIMA DI MONTAGGIO. 5. FISSAGGIO A PARETE DELL'APPARECCHIO.

6. COLLEGAMENTO IDRAGICO. 7. COLLEGAMENTO ELETTRICO. 8. PANNELLO DI CONTROLLO.

3. POSIZIONAMENTO DELL'APPARECCHIO. Diagram showing the unit placement with dimensions 225 cm and 60 cm.

4. UTILIZZO DELLA DIMA DI MONTAGGIO. Diagram showing the use of the installation jig.

5. FISSAGGIO A PARETE DELL'APPARECCHIO. Diagram showing the unit being fixed to the wall.

6. COLLEGAMENTO IDRAGICO. Diagram showing the water connection with a 5 cm gap.

7. COLLEGAMENTO ELETTRICO. Diagram showing the electrical connection to a power source.

8. PANNELLO DI CONTROLLO. Diagram showing the control panel with labels A through F.

EN QUICK START INSTALLATION INSTRUCTIONS. 1. ACCESSORIES. 2. INSTALLATION APPROACH. 3. POSITIONING THE APPLIANCE. 4. USING THE INSTALLATION JIG. 5. FIXING THE APPLIANCE TO THE WALL. 6. PLUMBING CONNECTIONS. 7. ELECTRICAL CONNECTIONS. 8. CONTROL PANEL.

FR QUICK START INSTRUCTIONS D'INSTALLATION. 1. ACCESSOIRES. 2. APPROCHE DE L'INSTALLATION. 3. POSITIONNEMENT DE L'APPAREIL. 4. UTILISATION DU GABARIT DE MONTAGE. 5. FIXATION DE L'APPAREIL. 6. RACCORDEMENT HYDRAULIQUE. 7. RACCORDEMENT ELECTRIQUE. 8. PANNEAU DE MANDOS.

ES QUICK START INSTRUCCIONES DE INSTALACION. 1. ACCESORIOS. 2. UBICACION DEL APARATO. 3. POSICIONAMIENTO DEL APARELLO. 4. PLANTILLA DE MONTAJE. 5. FIJACION A LA PARED DEL APARATO. 6. CONEXION HIDRAULICA. 7. CONEXION ELECTRICA. 8. PANEL DE MANDOS.

6. Készülék felszerelése. 1. Tartozékok. 2. Felszerelés. 3. Készülék elhelyezése. 4. Felszerelési sablon használata.

8. MODEL A MODEL B MODEL C. Diagrams showing the control panels for different models.

HU Gyors Üzembehelyezési útmutató. 1. TARTOZÉKOK. 2. FELSZERELÉS. 3. KÉSZÜLÉK ELHELYEZÉSE. 4. FELSZERELÉSI SABLON HASZNÁLATA.

DE QUICK START INSTALLATIONSANLEITUNG. 1. ZUBEHÖR. 2. VORBEREITUNG FÜR DIE INSTALLATION. 3. POSITIONIERUNG DES GERÄTS. 4. VERWENDUNG DER MONTAGEGABRIELLE.

LT GREITOS PRADŽIOS VADOVAS. 1. PRIEDAI. 2. ĮRENGIMAS. 3. ĮREIKŠNŲ MONITAVIMAS. 4. PRIETAISŲ ĮRENGIMAS. 5. PRIETAISŲ ĮRENGIMAS PARIKIMAMS. 6. VANDENTIEKIO JUNGTYS. 7. STROMANSCHLUS. 8. VANDENTIEKIO JUNGTYS. 9. PROBLEMŲ SPRENDIMAS.

7. ELEKTROMOS CSATLAKOZÁS. 7A. ELEKTROMOS CSATLAKOZÁS. 7B. ELEKTROMOS CSATLAKOZÁS. Diagrams showing the electrical connection process.

9. PROBLÉMA MEGOLDÁS. Diagram showing a person reading a manual and a power switch.

ARISTON QUICK START

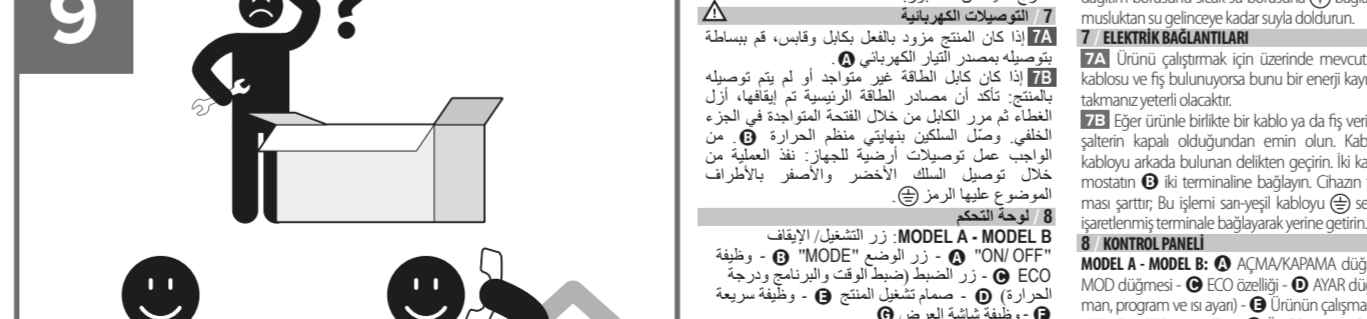
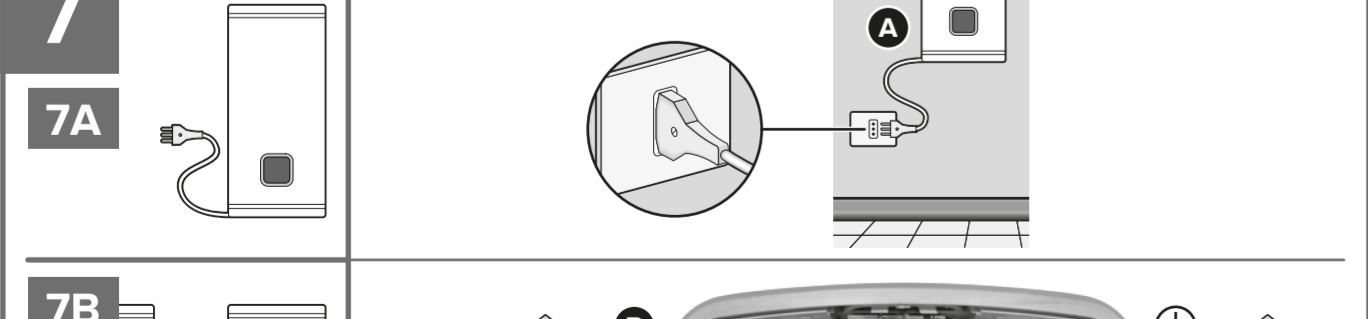
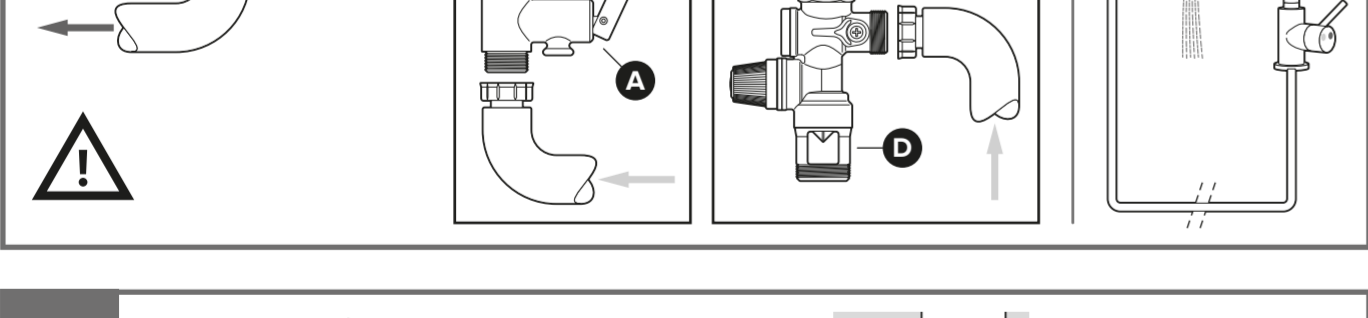
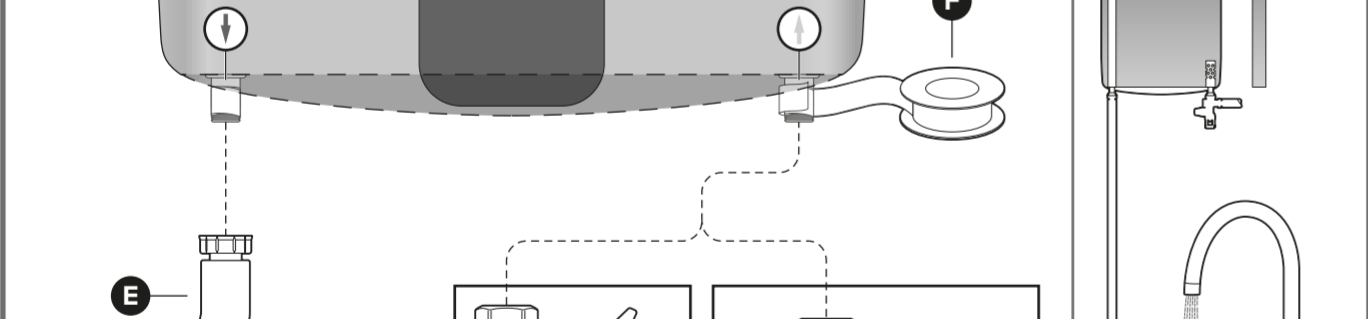
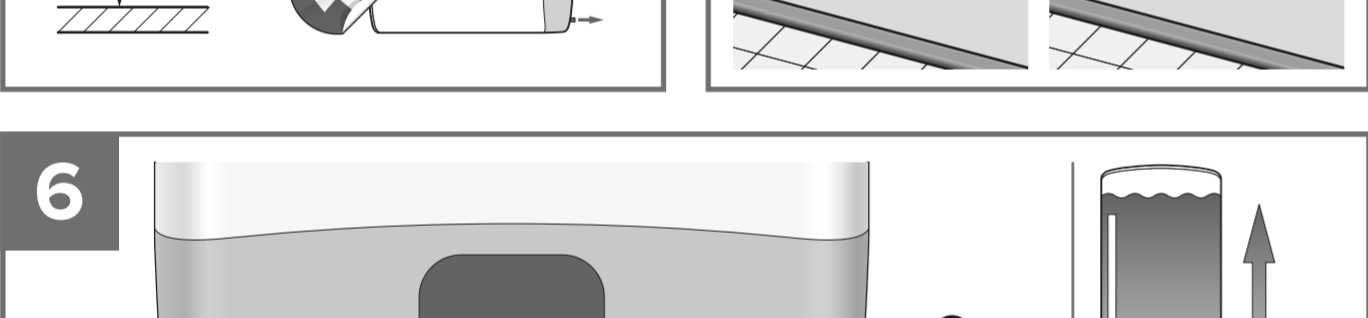
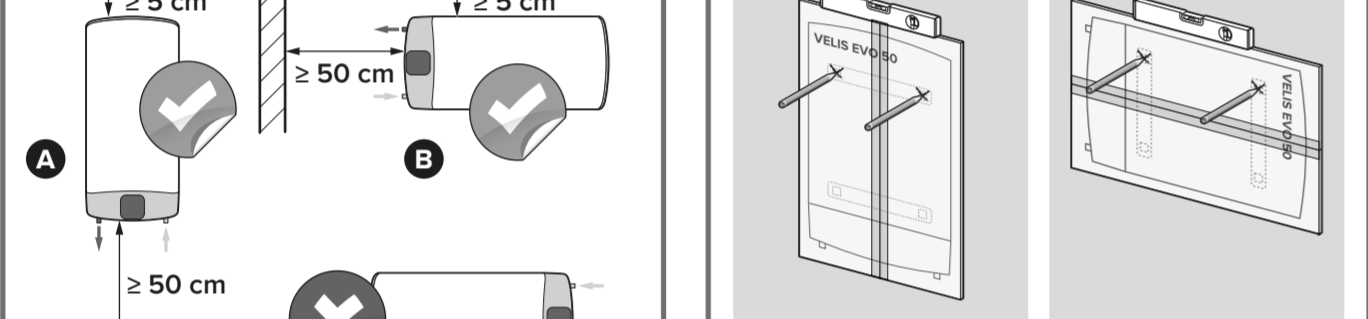
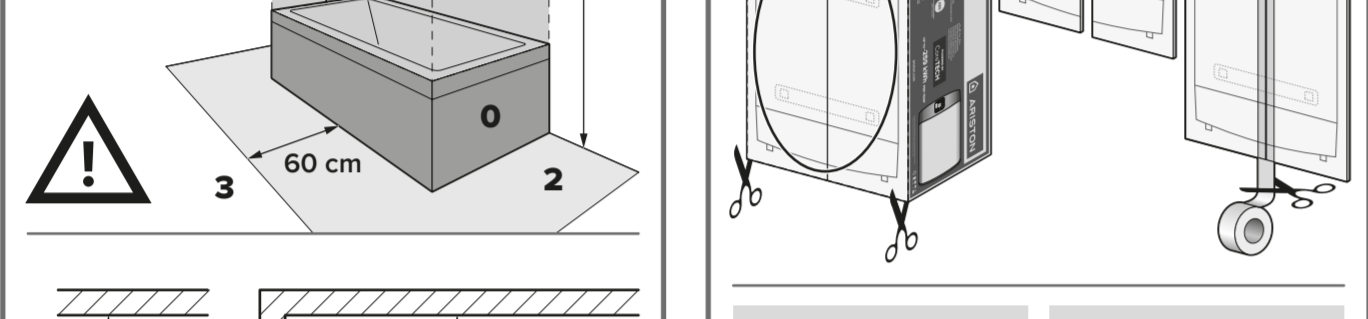
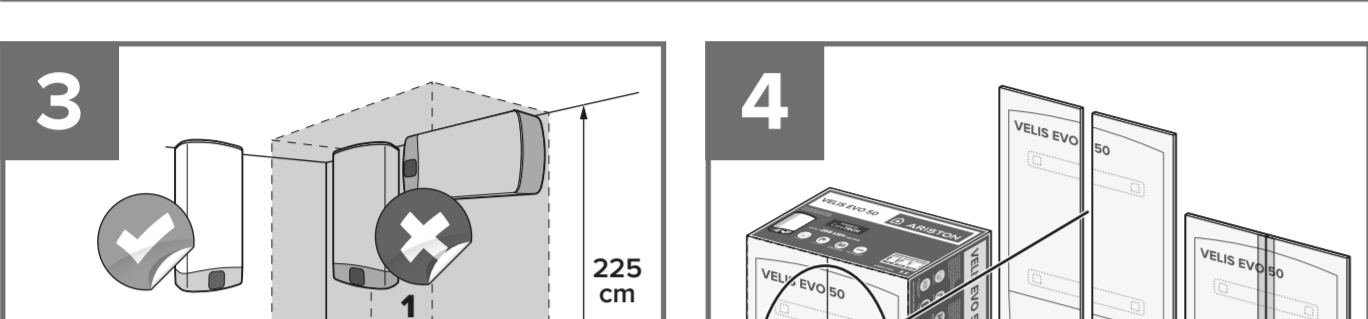
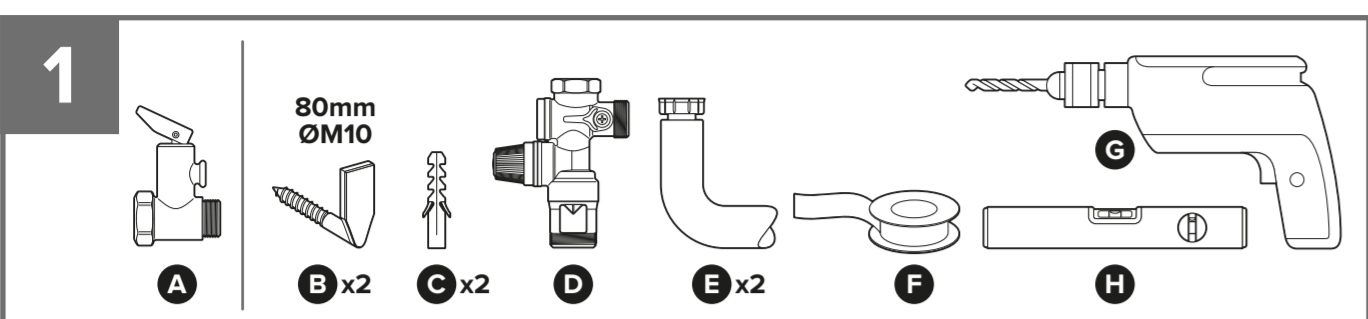

QUICK START INSTRUKCIJA ZA INSTALACIJE

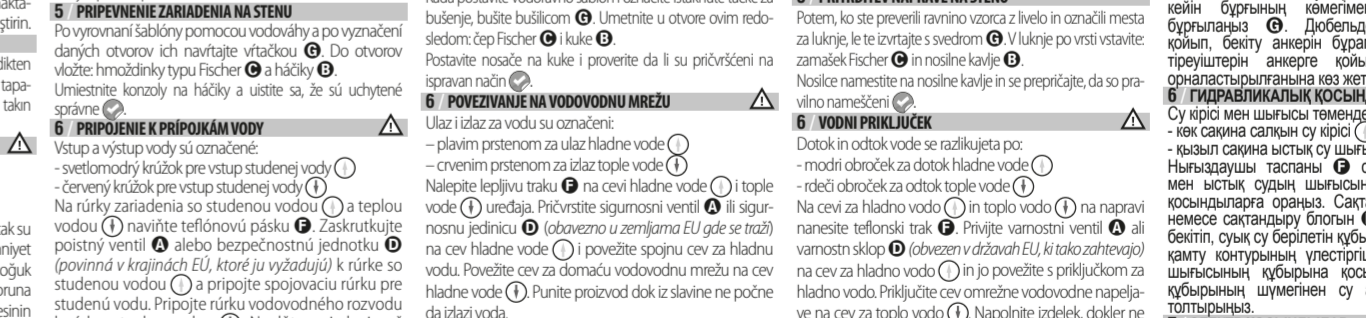

QUICK START INSTRUCȚIUNI DE INSTALARE

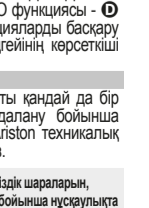
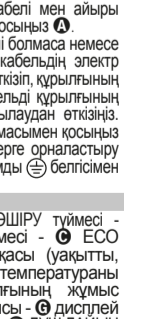
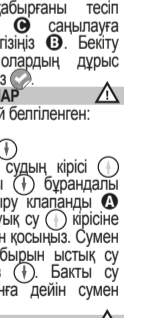
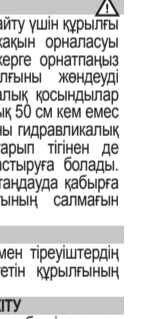
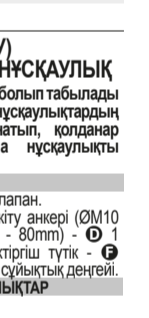
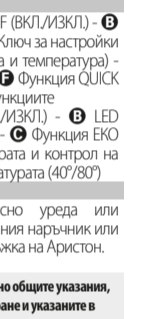
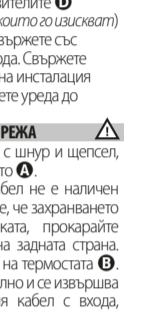
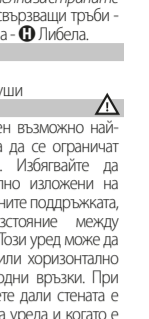

ET KIIRIJUHEND PAIGALDUSJUHEND

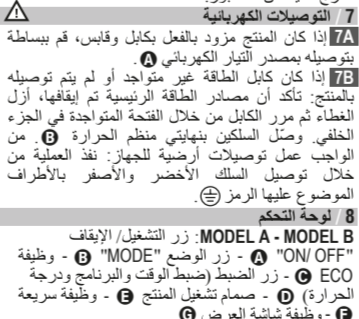
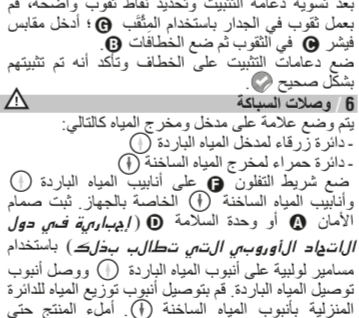
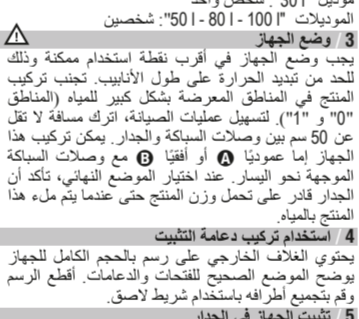

RU QUICK START (БЫСТРЫЙ СТАРТ) ИНСТРУКЦИЯ ПО УСТАНОВКЕ



PL QUICK START INSTRUKCIJA ZA INSTALACIJE

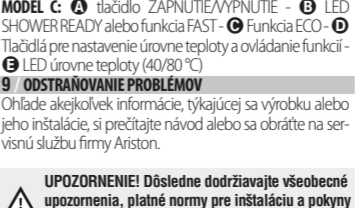
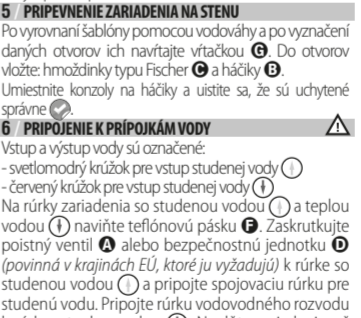
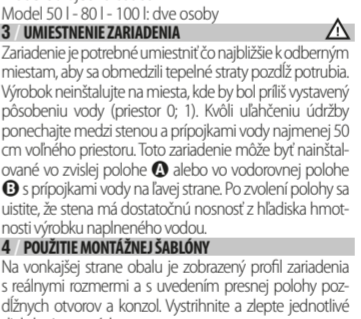
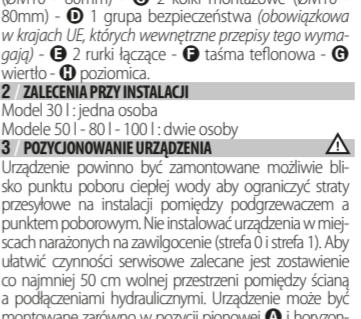

HR QUICK START UPUTE ZA INSTALIRANJE

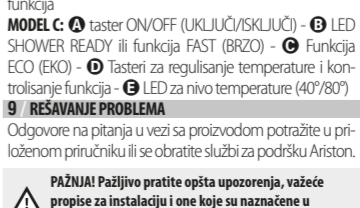

RO INSTALARE RAPIDĂ INSTRUCȚIUNI DE INSTALARE

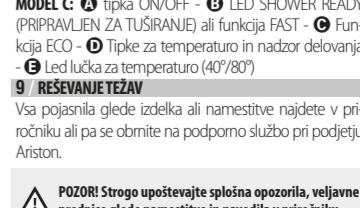

BG QUICK START ИНСТРУКЦИЈА ЗА ИНСТАЛИРАНЕ



QUICK START تعليمات التركيب العربية

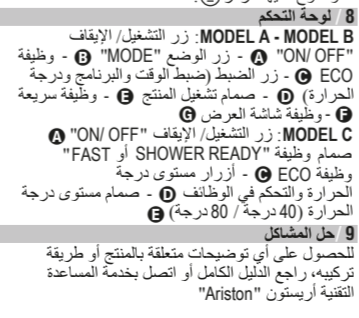
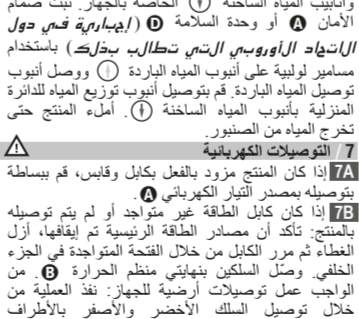
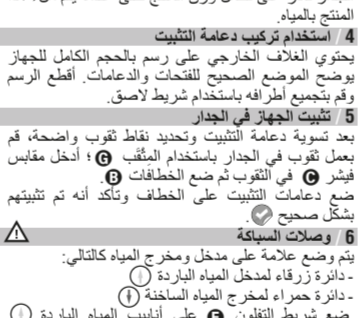
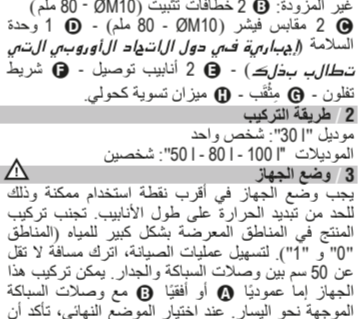

TR HIZLI BASLAMA MONTAJ TALİMATLARI

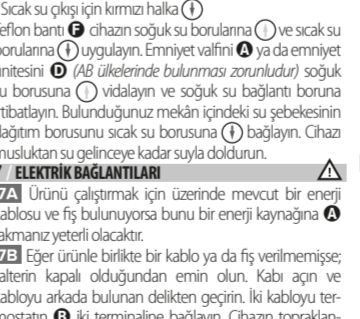

SK QUICK START POKYNY PRE INŠTALACIJE

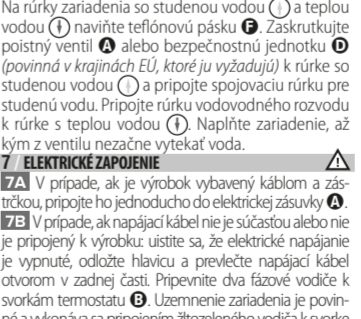
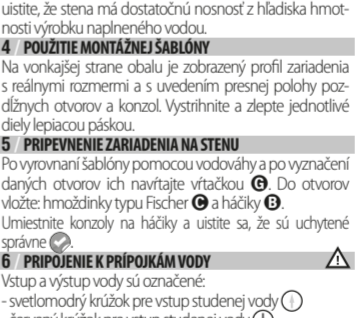

RS QUICK START UPUTSTVO ZA INSTALACIJU

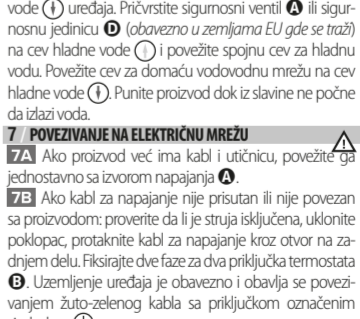

SL QUICK START NAVODILA ZA NAMESTEVITE

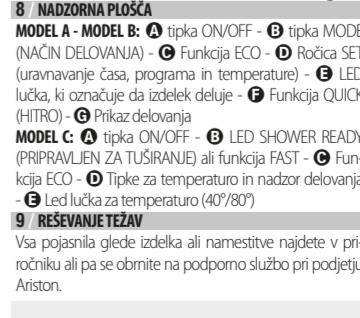
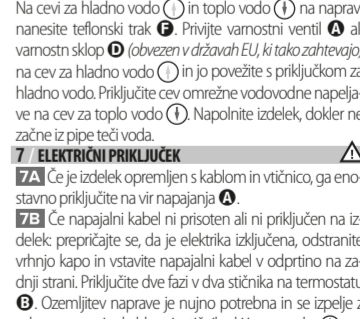

KZ (ЖЫЛДАМ ИСКЕ КОСУ) ОРНАТУУ БОЙШЫНА НҮСКАЛТЫК



Ovaj dokument je originalno proizveden i objavljen od strane proizvođača, brenda Ariston, i preuzet je sa njihove zvanične stranice. S obzirom na ovu činjenicu, Tehnoteka ističe da ne preuzima odgovornost za tačnost, celovitost ili pouzdanost informacija, podataka, mišljenja, saveta ili izjava sadržanih u ovom dokumentu.

Napominjemo da Tehnoteka nema ovlašćenje da izvrši bilo kakve izmene ili dopune na ovom dokumentu, stoga nismo odgovorni za eventualne greške, propuste ili netačnosti koje se mogu naći unutar njega. Tehnoteka ne odgovara za štetu nanесenu korisnicima pri upotrebi netačnih podataka. Ukoliko imate dodatna pitanja o proizvodu, ljubazno vas molimo da kontaktirate direktno proizvođača kako biste dobili sve detaljne informacije.

Za najnovije informacije o ceni, dostupnim akcijama i tehničkim karakteristikama proizvoda koji se pominje u ovom dokumentu, molimo posetite našu stranicu klikom na sledeći link:

<https://tehnoteka.rs/p/ariston-bojler-velis-evo-50-eu-akcija-cena/>