

Informacije o proizvodu (EN)

ANTEC napajanje NE700G 700W



Tehnoteka je online destinacija za upoređivanje cena i karakteristika bele tehnike, potrošačke elektronike i IT uređaja kod trgovinskih lanaca i internet prodavnica u Srbiji. Naša stranica vam omogućava da istražite najnovije informacije, detaljne karakteristike i konkurentne cene proizvoda.

Posetite nas i uživajte u ekskluzivnom iskustvu pametne kupovine klikom na link:

<https://tehnoteka.rs/p/antec-napajanje-ne700g-700w-akcija-cena/>

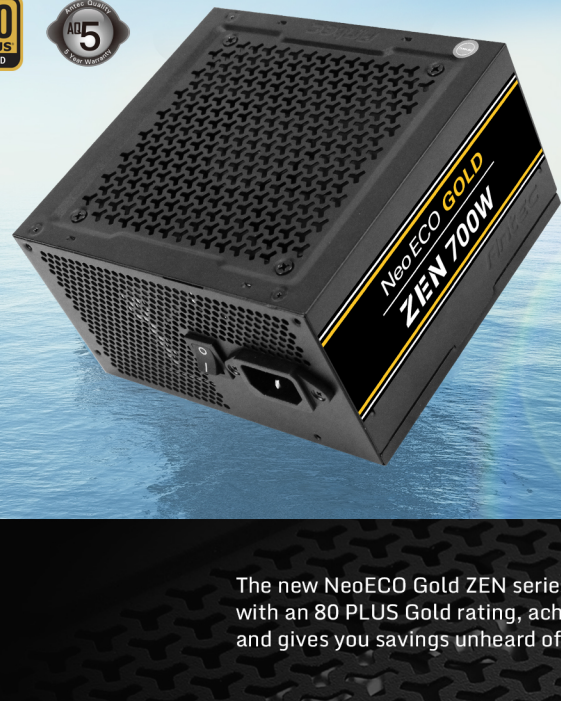

Neo ECO GOLD

ZEN 700W

Efficient & Affordable

The new NeoECO Gold ZEN series features high performance with an 80 PLUS Gold rating, achieving up to 92% efficiency and gives you savings unheard of from other power supplies.



80 PLUS Gold Certified

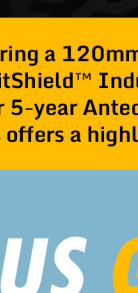

Stable Output

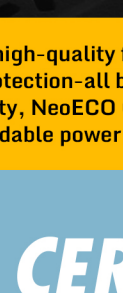

Japanese Heavy-Duty Caps



DC to DC Converter Design

Featuring a 120mm whisper-quiet high-quality fan and CircuitShield™ Industrial Grade Protection-all backed up by our 5-year Antec Quality Warranty, NeoECO Gold ZEN series offers a highly efficient, affordable power solution.

80 PLUS GOLD CERTIFIED

Reducing your electricity bill, guarantees up to efficiency of 92% under normal conditions. Japanese capacitors provide high efficiency DC to DC stability.



JAPANESE HEAVY-DUTY CAPS

Japanese capacitors ensure the tightest DC stability and regulation, for reliability that you and your system can count on.

LLC + DC TO DC DESIGN

A server-class Half-Bridge LLC design with a synchronous rectification based on a DC-DC topology.

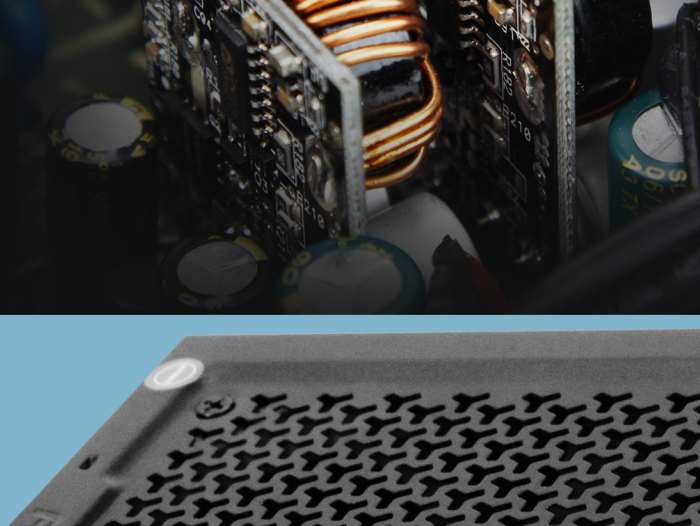

99% +12V OUTPUT

Engineered with high-quality capacitors and low-noise transformers, the NeoECO Gold ZEN series provide clean, stable power with maximum CPU & GPU support



ANTEC 5-YEAR WARRANTY

We stand by the quality and safety of the NeoECO Gold ZEN Supplies, offering a 5-year parts and labor warranty and unlimited access to our incomparable technical support and customer service.

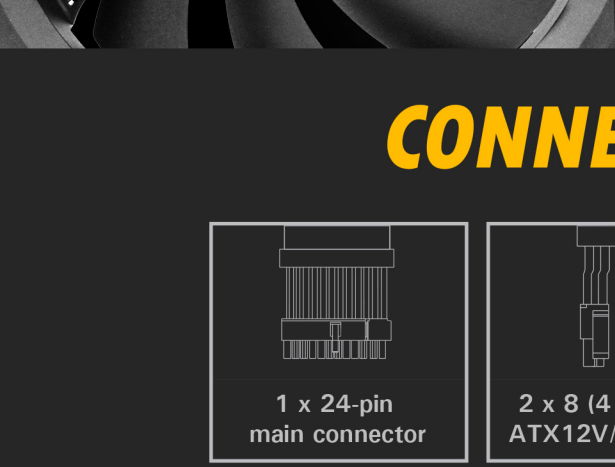

120 MM SILENT FAN

Features a Thermal Manager, an advanced low voltage fan control for optimal heat & noise management and will allow your PSU to stay at an optimal temperature.

CONNECTORS



1 x 24-pin main connector



2 x 8 (4+4)-pin ATX 12V / EPS 12V



4 x 8 (6+2)-pin PCI-E

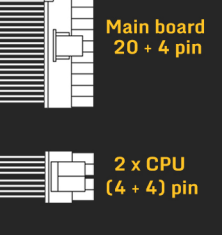

6 x SATA

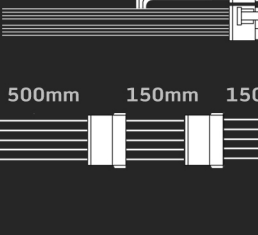

2 x Molex

CABLE QTY & LENGTH

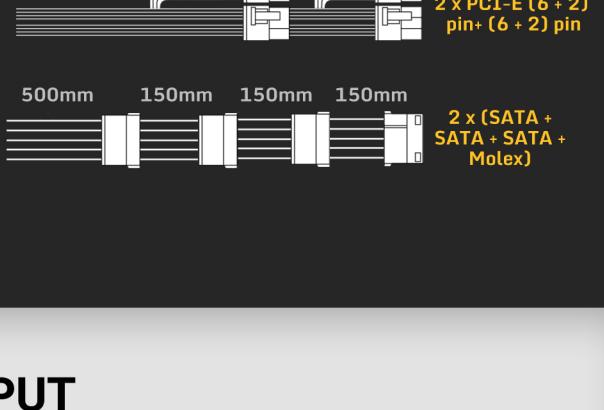
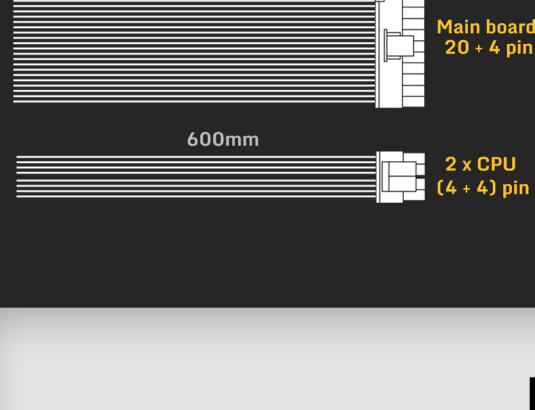

INPUT

100V~240VAC, 50Hz-60Hz, 10A-5A

OUTPUT

+3.3V	+5V	+12V	-12V	+5VSB
18A	18A	58A	0.3A	2.5A
100W		696W	3.6W	12.5W
700W				



Neo ECO GOLD

ZEN

- 700W Continuous Power™ - Guaranteed of Continuous Power™ from Antec
- 80 PLUS® Gold certified-Up to 92% efficient, to reduce your electricity bill
- AQ5 - Antec Quality 5 year warranty
- 120 mm Silence - Whisper-quiet high-quality fan with long lifetime
- 99% +12V - Output for maximum CPU & GPU support
- Japanese Heavy-Duty - High-quality capacitors ensure DC stability and regulation
- Half-Bridge LLC design with a synchronous rectification based on a DC-DC topology
- 4 x PCI-E connectors for multiple GPU support
- ATX12V 2.4 - Engineered according to the newest PSU guideline and compatible with the latest CPU generation
- CircuitShield™ - Full suite of industrial grade protections: OCP/OVP/UVP/SCP/OPP/NLO

Specification

Type	ATX 12V 2.4
Dimension	140(L) x 150(W) x 86(H) mm
Input Voltage	100-240 VAC
Input Current	10A-5A
Input Frequency Range	50Hz-60Hz
PFC	Active PFC
Power Good Signal	100-500ms
Efficiency	Up To 92%
Protection	OCP/OVP/UVP/SCP/OPP/NLO
Output Capacity	700W
Operation Temperature	0~40°C
Regulatory	cTUVus/TUV/CB/RCM/CE/CCC/BSMI/FCC/KC
Fan	120mm Silence Fan
Certifications	80 Plus Gold
Connector	1 x MB 24(20+4) Pin
	2 x 8(4+4) Pin ATX 12V / EPS 12V
	4 x 8(6+2) Pin PCI-E
	6 x SATA
	2 x Molex
Net Weight	1.79 Kgs
Gross Weight	2.17 Kgs
Warranty	5 Years
UPC#	0-761345-11686-2 NE700G ZEN 0-761345-11687-9 NE700G ZEN AU 0-761345-11688-6 NE700G ZEN EC 0-761345-11689-3 NE700G ZEN GB 0-761345-11690-9 NE700G ZEN JP

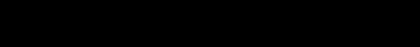

Ovaj dokument je originalno proizveden i objavljen od strane proizvođača, brenda Antec, i preuzet je sa njihove zvanične stranice. S obzirom na ovu činjenicu, Tehnoteka ističe da ne preuzima odgovornost za tačnost, celovitost ili pouzdanost informacija, podataka, mišljenja, saveta ili izjava sadržanih u ovom dokumentu.

Napominjemo da Tehnoteka nema ovlašćenje da izvrši bilo kakve izmene ili dopune na ovom dokumentu, stoga nismo odgovorni za eventualne greške, propuste ili netačnosti koje se mogu naći unutar njega. Tehnoteka ne odgovara za štetu nanесenu korisnicima pri upotrebi netačnih podataka. Ukoliko imate dodatna pitanja o proizvodu, ljubazno vas molimo da kontaktirate direktno proizvođača kako biste dobili sve detaljne informacije.

Za najnovije informacije o ceni, dostupnim akcijama i tehničkim karakteristikama proizvoda koji se pominje u ovom dokumentu, molimo posetite našu stranicu klikom na sledeći link:

<https://tehnoteka.rs/p/antec-napajanje-ne700g-700w-akcija-cena/>