

Uputstvo za upotrebu

UNION električni šporet W-60.0

 UNION



Tehnoteka je online destinacija za upoređivanje cena i karakteristika bele tehnike, potrošačke elektronike i IT uređaja kod trgovinskih lanaca i internet prodavnica u Srbiji. Naša stranica vam omogućava da istražite najnovije informacije, detaljne karakteristike i konkurentne cene proizvoda.

Posetite nas i uživajte u ekskluzivnom iskustvu pametne kupovine klikom na link:

<https://tehnoteka.rs/p/union-elektricni-sporet-w-600-akcija-cena/>

UNION



SR Samostojeći šporet / Uputstvo za upotrebu

EN Free Standing Cooker / User Manual

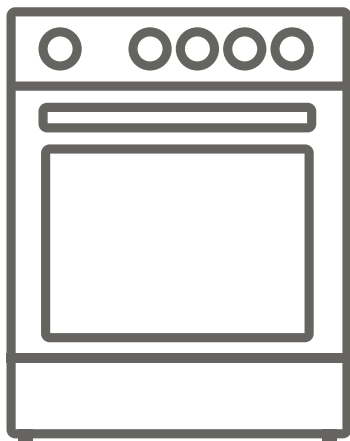

W-60.0

Hvala vam što ste odabrali naš proizvod.

Ovo Uputstvo za upotrebu sadrži važne sigurnosne informacije i uputstva za rukovanje i održavanje vašeg uređaja.

Molimo vas da pročitate ovo Uputstvo za upotrebu pre korišćenja vašeg uređaja i čuvajte ovo uputstvo za ubuduće.

Simbol	Tip	Značenje
	UPOZORENJE	Rizik od ozbiljne povrede ili smrti
	RIZIK OD ELEKTRIČNOG UDARA	Rizik od visokog napona
	POŽAR	Upozorenje: Rizik od požara / zapaljivi materijali
	PAŽNJA	Rizik od povrede ili štete
	VAŽNA NAPOMENA	Pravilno rukovanje sistemom

SADRŽAJ

1.BEZBEDNOSNA UPUTSTVA.....	4
1.1 Opšta bezbednosna upozorenja.....	4
1.2 Upozorenja kod instalacije.....	7
1.3 Tokom upotrebe.....	7
1.4 Tokom čišćenja i održavanja.....	9
2.INSTALACIJA I PRIPREMA ZA UPOTREBU	10
2.1 Uputstvo za instalaciju.....	10
2.2 Električno povezivanje i bezbednost	11
2.3 KOMPLET PROTIV NAGINJANJA.....	12
2.4 Podešavanje nogara.....	12
3.KARAKTERISTIKE PROIZVODA.....	13
4.KORIŠĆENJE PROIZVODA.....	14
4.1 Kontrole ploče za kuvanje	14
4.2 Kontrole rerne.....	15
4.3 Tabela za kuvanje.....	15
4.5 Dodatna oprema.....	15
5.ČIŠĆENJE I ODRŽAVANJE	16
5.1 Čišćenje	16
5.2 Održavanje	18
6.REŠAVANJE PROBLEMA & TRANSPORT	19
6.1 Rešavanje problema.....	19
6.2 Transport	19
7.TEHNIČKE SPECIFIKACIJE.....	20
7.1 Energetska klasa.....	20



1. BEZBEDNOSNA UPUTSTVA

- Pažljivo i u potpunosti pročitajte sva uputstva pre korišćenja uređaja i sačuvajte ih na pristupačnom mestu za upotrebu po potrebi.
- Ovo uputstvo je namenjeno za više od jednog modela pa vaš uređaj možda nema sve opisane funkcije. Zato je važno obratiti posebnu pažnju na sve slike kada čitate uputstvo za upotrebu.

1.1 OPŠTA BEZBEDNOSNA UPOZORENJA

- Ovaj uređaj mogu koristiti deca starija od 8 godina i osobe sa smanjenim fizičkim, senzornim ili mentalnim sposobnostima ili osobe kojima nedostaju iskustvo i znanje, ako su pod nadzorom ili su dobili uputstva u vezi sa bezbednom upotrebom uređaja i razumeju uključene opasnosti. Deca se ne smeju igrati sa uređajem. Deca ne smeju čistiti ili održavati uređaj bez nadzora.

 **UPOZORENJE:** Uređaj i njegovi pristupačni delovi se zagrevaju tokom upotrebe. Budite pažljivi da bi izbegli dodirivanje vrućih elemenata. Decu mlađu od 8 godina treba udaljiti osim u slučaju da ih neprekidno nadgledate.

  **UPOZORENJE:** Kuvanje na ringli sa zagrejanom masti ili uljem bez nadzora može biti opasno i dovesti do požara. NIKADA ne pokušavajte da gasite vatru vodom, već isključite uređaj, a zatim pokrijte plamen poklopcem ili protivpožarnim ćebetom.

 **PAŽNJA:** Proces kuvanja mora biti pod nadzorom. Kratkotrajno kuvanje mora biti pod neprestanim nadzorom.

  **UPOZORENJE:** Opasnost od požara: Nemojte

čuvati predmete na površinama za kuvanje.

 **UPOZORENJE:** Ako je površina naprsla, isključite uređaj da biste izbegli mogućnost električnog udara.

- Za modele sa poklopcem za ploču, očistite sve što je prosuto po poklopcu pre upotrebe i ostavite šporet da se ohladi pre zatvaranja poklopcu.
- Ovaj aparat nije predviđen da se upravlja putem eksternog tajmera ili posebnog sistema daljinskog upravljača.

 **UPOZORENJE:** Potrebno je postaviti podupirače za stabilnost da bi se sprečilo prevrtanje uređaja. (Za detaljne informacije proverite uputstvo za komplet protiv naginjanja.)

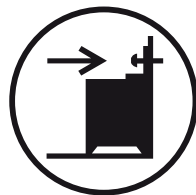

- Uređaj se zagreva tokom korišćenja. Budite pažljivi da biste izbegli dodirivanje grejnih elemenata unutar rerne.
- Ručke mogu postati vruće nakon kratkotrajne upotrebe.
- Ne koristite abrazivna sredstva ili čelične četke za čišćenje površina u rerni. Tako se mogu ogrebat površine i može doći do pucanja stakla na vratima ili do oštećenja površina.
- Ne koristite paročistače za čišćenje uređaja.

 **UPOZORENJE:** Da bi izbegli rizik od električnog udara, vodite računa da isključite uređaj pre zamene sijalice.

 **PAŽNJA:** Pristupačni delovi mogu biti vrući kada se kuva ili peče. Vodite računa da se deca ne približavaju uređaju dok se koristi.

- Vaš uređaj je proizveden u skladu sa svim

primenljivim lokalnim i međunarodnim standardima i propisima.

- Radove na održavanju i popravci moraju da vrše ovlašćeni serviseri. Instalacija i popravka koje obavljaju neovlašćeni tehničari predstavljaju opasnost po vas. Zabranjeno je menjati specifikacije proizvoda na bilo koji način. Upotreba nepravilnih štitnika za ploče može dovesti do nesrećnog slučaja.
- Pre povezivanja uređaja, proverite da li su lokalni uslovi distribucije (karakteristike i pritisak gasa ili napon i frekvencija električne energije) i specifikacije uređaja kompatibilni. Specifikacije za ovaj uređaj su navedene na etiketi.

 **PAŽNJA:** Ovaj uređaj je namenjen isključivo za pripremu hrane i samo za unutrašnju upotrebu u domaćinstvima. Ne treba ga koristiti u druge svrhe ili primene, kao što je upotreba van domaćinstva, u komercijalnom okruženju ili za zagrevanje prostorije.

- Ne koristite ručke vrata rerne za podizanje ili pomeranje uređaja.
- Sve moguće mere su preduzete kako bi se osigurala vaša bezbednost. S obzirom na to da staklo može pući, treba da budete oprezni prilikom čišćenja da biste izbegli grebanje. Izbegavajte udaranje ili lupanje stakla dodacima.
- Postarajte se da kabel za napajanje ne bude presavijen ili oštećen tokom instalacije. Ako se kabel za napajanje ošteti, proizvođač, njegovo servisno osoblje ili slične kvalifikovane osobe, treba da ga zamene da bi se sprečila opasnost.
- Ne dozvoljavajte deci da se penju ili da sede na vratima rerne kada su otvorena.
- Molimo vas udaljite decu i kućne ljubimce od ovog



uređaja.

1.2 UPOZORENJA KOD INSTALACIJE

- Nemojte da koristite uređaj pre nego što bude u potpunosti instaliran.
- Ovaj uređaj mora da instalira ovlašćeni serviser. Proizvođač nije odgovoran za bilo kakve štete nastale zbog pogrešnog postavljanja i instalacije od strane neovlašćenih osoba.
- Kada odpakujete uređaj, proverite da li je oštećen tokom transporta. U slučaju ikakvog nedostatka, nemojte da koristite uređaj i odmah kontaktirajte kvalifikovanog servisera. S obzirom na to da materijali koji se koriste za pakovanje (najlon, spjalice, pena itd.) mogu biti štetni po decu, treba ih sakupiti i odmah ukloniti.
- Zaštitite uređaj od atmosferskih uticaja. Ne izlažite uređaj suncu, kiši, snegu, prašini ili preteranoj vlazi.
- Materijali oko uređaja (kuhinjski elementi) moraju biti u stanju da izdrže temperaturu od najmanje 100 °C.
- Uređaj se ne sme postavljati iza dekorativnih vrata, da bi se izbeglo pregrevanje.

1.3 TOKOM UPOTREBE

- Kada prvi put otvorite rernu, možda ćete primetiti blag miris. Ovo je potpuno normalno i dolazi od materijala za izolaciju grejača. Predlažemo, pre nego što prvi put koristite rernu, da je ostavite praznu i podesite na maksimalnu temperaturu na 45 minuta. Vodite računa prostorija gde je instaliran proizvod da bude dobro provetrena.
- Budite pažljivi ako otvarate vrata rerne za vreme ili nakon kuvanja. Vruća para iz rerne može izazvati opekotine.

- Nemojte da stavljate zapaljive ili eksplozivne materijale u uređaj ili u blizini uređaja dok radi.
 - Uvek koristite rukavice za rernu kada stavljate ili vadite hranu iz rerne.
 - Ni u kom slučaju pećnicu ne treba obložiti aluminijumskom folijom, jer može doći do pregrevanja.
 - Ne stavljajte posuđe ili tepsiju direktno na dno pećnice dok kuvate. Baza postaje vrlo vruća i na proizvodu može doći do oštećenja.
-   Ne ostavljajte šporet bez nadzora dok kuvate na masti ili ulju. Oni se mogu zapaliti u uslovima visoke toplote. Nikada ne sipajte vodu na požar izazvan uljem, već isključite šporet i pokrijte tiganj poklopcem ili protivpožarnim čebetom.
- Uvek postavite šerpe na centar zone za kuvanje i okrenite drške u bezbedni položaj tako da se ne mogu oboriti.
 - Ako nećete koristiti proizvod duže vremena, isključite glavni prekidač. Isključite ventil za plin kada ne koristite uređaje na gas.
 - Postarajte se da kontrolna dugmad uređaja uvek budu u položaju „0“ (stop) kada se ne koristi uređaj.
 - Poslužavnici se nagingju kada se izvlače. Vodite računa da ne prospete ili ispustite vruću hranu kada je vadite iz rerne.
 - Ne stavljajte ništa na vrata rerne dok su otvorena. Može doći do poremećaja ravnoteže ili do oštećenja vrata.
 - Ne stavljajte teške ili zapaljive predmete (na primer najlon, plastične kese, hartiju, krpe, i sl.) u fioku. Ovo važi i za pribor za kuvanje sa plastičnim delovima (na primer drškama).

 **PAŽNJA:** Unutrašnja površina fioke može se zagrejati kada se koristi uređaj. Izbegavajte dodir sa unutrašnjom površinom.

- Ne ostavljajte peškire, kuhinjske ili druge krpe na uređaj ili na drške.

1.4 TOKOM ČIŠĆENJA I ODRŽAVANJA

- Vodite računa uređaj da bude isključen iz napajanja pre bilo kakvog čišćenja ili održavanja.
- Ne uklanjajte komandnu dugmad radi čišćenja komandne table.
- Da biste održali efikasnost i bezbednost uređaja, preporučujemo vam da uvek koristite originalne rezervne delove i zovete samo naše ovlašćene servisere, ako je potrebno.

CE izjava o usklađenosti

 Izjavljujemo da naši proizvodi zadovoljavaju primenljive evropske direktive, odluke i propise, kao i zahteve navedene u naznačenim standardima.

Ovaj uređaj je projektovan za korišćenje samo u svrhe kuvanja kod kuće. Svaka druga upotreba (kao što je zagrevanje prostorije) je nepravilna i opasna.

 Uputstvo za upotrebu važi za nekoliko modela. Možda ćete primetiti razlike između ovog uputstva i vašeg modela.

2. INSTALACIJA I PRIPREMA ZA UPOTREBU

! **UPOZORENJE** : Instalaciju uređaja treba da obavi ovlašćeni serviser ili kvalifikovani električar, u skladu sa uputstvima u ovom priručniku i u skladu sa važećim lokalnim propisima.

- Nepravilna instalacija može dovesti do povrede i štete, u kom slučaju proizvođač se ograđuje od odgovornosti i garancija nije validna.
- Pre instalacije, proverite da li su lokalni uslovi distribucije (napon i frekvencija električne energije i/ili karakteristike i pritisak gasa) i podešavanja na uređaju kompatibilni. Uslovi za podešavanje ovog uređaja su navedeni na etiketi.
- Potrebno je poštovati zakone, propise, direktive i standarde na snazi u državi korišćenja (bezbednosni propisi, pravilna reciklaža u skladu sa propisima itd.).

2.1 UPUTSTVO ZA INSTALACIJU

Opšta uputstva

- Nakon uklanjanja pakovanja sa uređaja i sa dodataka, proverite da li je uređaj oštećen. Ako mislite da ima bilo kakvog oštećenja, ne koristite uređaj i odmah pozovite ovlašćeni servis ili kvalifikovanog električara.
- Vodite računa da ne čuvate nikakve zapaljive ili eksplozivne materijale u neposrednoj blizini, kao što su zavese, ulje, krpe ili slični predmeti koji se mogu zapaliti.
- Radna površina i nameštaj oko uređaja moraju biti napravljeni od materijala otporni na temperature preko 100 °C.
- Ovaj uređaj ne treba postaviti direktno iznad mašine za sudove, frižidera, zamrzivača, mašine za pranje ili sušenje veša.
- Šporet se može postaviti u blizini drugog nameštaja pod uslovom da na mestu postavljanja šporeta nameštaj nije viši od ploče za kuvanje.

Instalacija šporeta

- Ako je kuhinjski nameštaj viši od ploče za kuvanje, nameštaj mora biti najmanje 10 cm udaljen od strana uređaja da bi se omogućila cirkulacija vazduha.

- Ako je aspirator ili kuhinjski element postavljen iznad uređaja, potrebno je ostaviti bezbedno rastojanje između ploče za kuvanje i aspiratora/kuhinjskog elementa kao što je dato na slici.

A (mm) Kuhinjski element	420
B (mm) Aspirator	650/700
C (mm)	Širina proizvoda
D (mm)	50

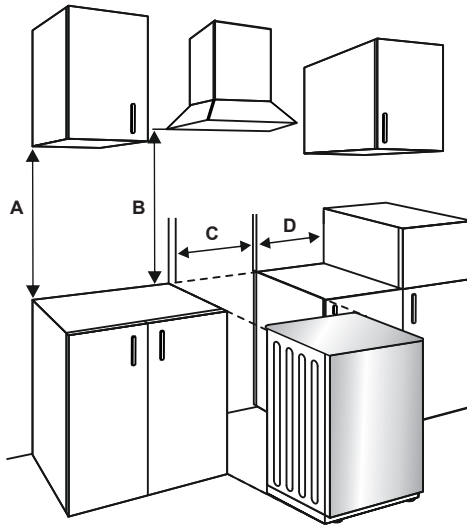

2.2 ELEKTRIČNO POVEZIVANJE I BEZBEDNOST

! UPOZORENJE: Povezivanje napajanja na električnu energiju za ovaj uređaj treba da obavi ovlašćeni serviser ili kvalifikovani električar, u skladu sa uputstvima u ovom priručniku i u skladu sa važećim lokalnim propisima.

! UPOZORENJE: OVAJ UREĐAJ MORA DA BUDE UZEMLJEN.

- Pre nego što povežete uređaj na napajanje, morate proveriti nominalni napon uređaja (odštampan na pločici za identifikaciju uređaja) da budete sigurni da odgovara vašem naponu napajanja električnom energijom, i da električna instalacija može da izdrži nominalnu struju uređaja (takođe navedena na pločici za identifikaciju).
- Tokom instalacije, postarajte se da koristite izolovane kablove. Nepravilno povezivanje može oštetiti uređaj. Ako je oštećen kabel distribucije i treba ga zameniti, to mora obaviti kvalifikovano lice.
- Ne koristite adaptere, više utičnica i/ili produžne kablove.
- Kabel za napajanje treba udaljiti od vrućih delova uređaja i ne sme se preklapati ili pritiskati. U suprotnom može doći do oštećenja kablova i kratkog spoja.

- Ako uređaj nije priključen na električnu mrežu utikačem, mora se koristiti osigurač (sa najmanje 3 mm prostora za kontakt) da bi se zapazili sigurnosni propisi.
- Uređaj je projektovan za napajanje od 220-240 V~.380-415 3N~ . Ako imate drugo napajanje, pozovite ovlašćeni servis ili kvalifikovanog električara.
- Kabel za napajanje (H05VV-F) mora biti dovoljno dug da bi se povezao uređaj.
- Prekidač za osigurač mora biti lako dostupan nakon instalacije uređaja.
- Vodite računa sve veze da su dobro pričvršćene.
- Priključite kabel za napajanje u utikač i zatvorite poklopac.
- Veza za priključnu kutiju se nalazi na priključnoj kutiji.

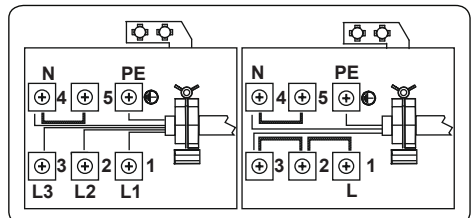

2.3 KOMPLET PROTIV NAGINJANJA

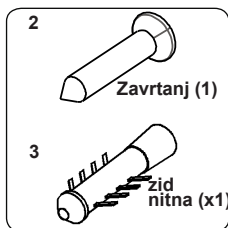

Kesa sa dokumentima sadrži komplet protiv naginjanja. Labavo prikačite podupirač protiv naginjanja (1) na zid koristeći zavrtanj (2) i nitnu (3), prema dimenzijama datim na slici i u tabeli. Podesite visinu podupirača protiv naginjanja da bude u liniji sa otvorom na šporetu i zategnite zavrtanj. Gurnite uređaj prema zidu da budete sigurni da je podupirač ušao u otvor na zadnjem delu uređaja.

kazaljka na satu. Da spustite uređaj, okrenite nogare u smeru kazaljki na satu. Možete podići uređaj do 30 mm podešavanjem nogari. Uređaj je težak pa preporučujemo da ga podižu najmanje 2 lica. Nikada ne vucite uređaj.

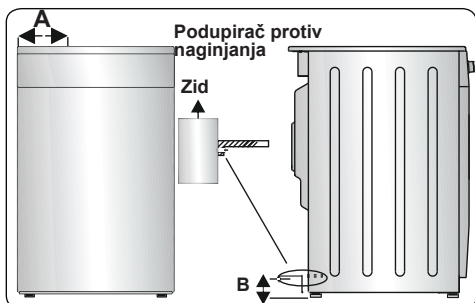
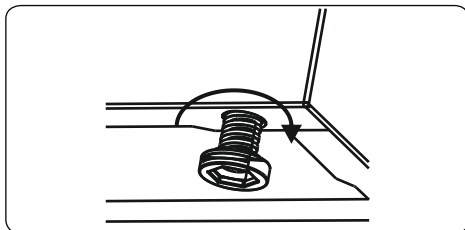

Dimenzije proizvoda (širina x dubina x visina) (cm)	A [mm]	B [mm]
60 x 60 x 90 (dvostruka rerna)	297.5	52
50 x 60 x 90 (dvostruka rerna)	247.5	52
90 x 60 x 85	430	107
60 x 60 x 90	309.5	112
60 x 60 x 85	309.5	64
50 x 60 x 90	247.5	112
50 x 60 x 85	247.5	64
50 x 50 x 90	247.5	112
50 x 50 x 85	247.5	64

2.4 PODEŠAVANJE NOGARA

Vaš proizvod stoji na četiri prilagodljive nogare. Za bezbedan rad, važno je vaš uređaj da se izbalansira. Vodite računa uređaj da bude ravan pre kuvanja. Da podignete uređaj, okrenite nogare suprotno

3. KARAKTERISTIKE PROIZVODA

 **Važno:** Specifikacije proizvoda variraju i izgled vašeg uređaja može se razlikovati od uređaja na slikama.

Spisak komponenti

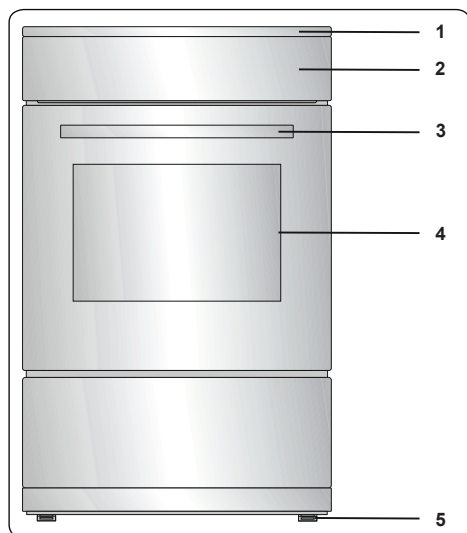

1. Ploča za kuvanje
2. Kontrolna tabla
3. Ručka rerne
4. Vrata rerne
5. Prilagodljive nogare

Kontrolna tabla

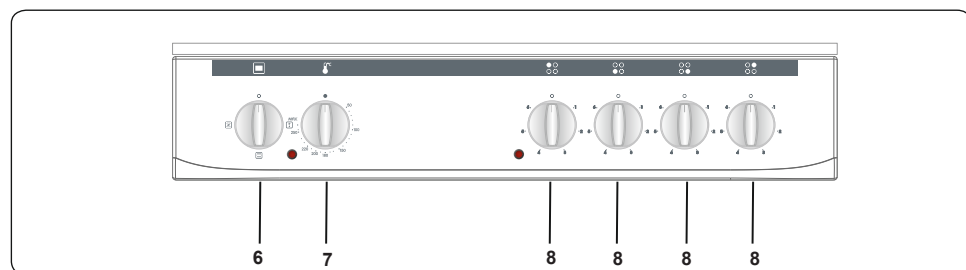

6. Kontrolni prekidač za funkcije šporeta
7. Termostatski prekidač rerne
8. Kontrolni prekidač za ringle

4. KORIŠĆENJE PROIZVODA

4.1 KONTROLE PLOČE ZA KUVANJE

Keramički grejač

Keramički grejač se kontroliše prekidačem sa 6 položaja.

Keramički grejač radi okretanjem kontrolnog prekidača na željenu postavku. Blizu svakog kontrolnog prekidača nalazi se simbol koji pokazuje grejač koji je kontrolisan tim prekidačem. Svetlo za uključeno/isključeno će se pojaviti na kontrolnoj tabli ako je bilo koji keramički grejač uključen.

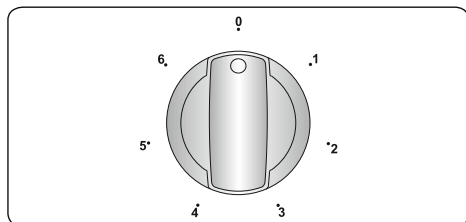

Položaj kontrolnog prekidača	Funkcija
0	Položaj za isključivanje
1	Položaj za održavanje toplote
2-3	Položaj za zagrevanje uz nisku toplotu
4-5-6	Kuvanje – pečenje i ključanje

 **Važno:** Pravac okretanja prekidača može se razlikovati u skladu sa specifikacijama proizvoda.

Dvostruki i ovalni grejači (ako su dostupni)

Dvostruki i ovalni grejači imaju dve toplotne zone. Da biste aktivirali spoljnu zonu dvostrukog/ovalnog grejača okrenite prekidač na položaj ☉. Obe spoljne zone će se uključiti.

Za deaktiviranje spoljne zone dvostrukog/ovalnog grejača okrenite prekidač na položaj "isključeno". Obe spoljne zone će se isključiti.

Indikator preostale toplote (ako je dostupan)

Posle upotrebe ploče za kuvanje ostaće nataložena toplota u vitrokeramičkom staklu koja se zove preostala toplota. Ako je nivo preostale toplote veći od +60°C, indikator preostale toplote će biti aktivan za zonu

kuvanja koja je iznad ove temperature.

Ako je napajanje ploče za kuvanje isključeno dok je indikator preostale toplote uključen, upaliće se upozoravajuće svetlo kada se napajanje ponovo priključi. Ekran će svetleti dok preostala temperatura na opadne ili dok je neka od zona za kuvanje aktivna.

Nagoveštaji i saveti

 **Važno:** Kada keramički grejači rade sa podešenjima za veću toplotu, zagrejane površine se mogu paliti i gasiti. Ovo je zbog bezbednosnog uređaja koji štiti staklo od pregrevavanja. Ovo je normalno na visokim temperaturama, ne izaziva oštećenje ploče za kuvanje i malo odlaže vreme kuvanja.

UPOZORENJE:

- Nikada nemojte da rukujete pločom za kuvanje bez posuđa na zonama za kuvanje.
- Koristite isključivo ravno posuđe sa dnom dovoljne debljine.
- Postarajte se da dno posude bude suvo pre postavljanja na ploču za kuvanje.
- Dok zona za kuvanje radi, važno je da posuda bude centrirana ispravno na zoni.
- Da biste sačuvali energiju nikada ne koristite posudu sa različitim prečnikom od ringle koju koristite.

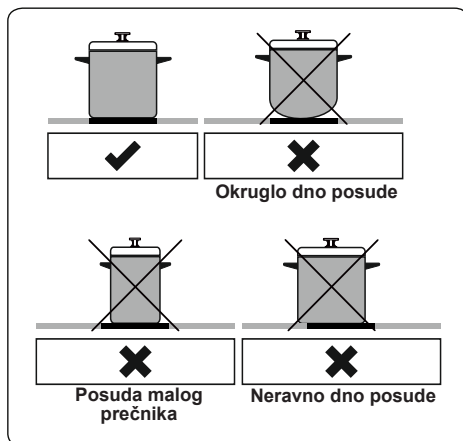

- Nemojte koristiti posude za kuvanje sa grubim dnom jer to može ogrebat i staklokeramičku površinu.
- Ako je moguće, uvek zatvarajte posude za kuvanje poklopcima.
- Temperatura pristupačnih delova može biti visoka dok je uređaj u radu. Držite decu i životinje na bezbednom rastojanju dok ploča za kuvanje radi i dok se ne ohladi potpuno nakon upotrebe.
- Ako primetite pukotinu na ploči za kuvanje, odmah je isključite i pozovite ovlašćenog servisera da je zameni.

4.2 KONTROLE RERNE

Prekidač za funkcije rerne

Okrenite prekidač na odgovarajući simbol željene funkcije za kuvanje. Za detalje različitih funkcija vidite „Funkcije rerne“.

Termostatski prekidač rerne

Nakon što odaberete funkciju za kuvanje, okrenite ovaj prekidač na željenu temperaturu. Svetlo za termostat rerne se uključuje uvek kada termostat radi da zagreje rernu ili da održi temperaturu.

Funkcije rerne

* Funkcije vaše rerne se mogu razlikovati u zavisnosti od modela vašeg proizvoda.

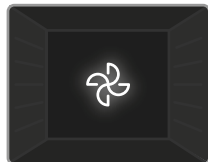

Funkcija odmrzavanja: Svetiljka za upozorenje na rerni će se upaliti i ventilator će početi da radi. Za upotrebu funkcije odmrzavanja,

stavite zamrznutu hranu u rernu na policu postavljenu u trećem ležištu od dna. Preporučuje se da postavite pleh ispod hrane koja se odmrzava, da biste prikupili vodu koja se sakuplja usled topljenja leda. Ova funkcija neće skuvati ili ispeći vašu hranu, samo će pomoći odmrzavanje.



Funkcija statičko pečenje: Termostat i svetiljka za upozorenje na rerni će se uključiti, i donji i gornji grejači će početi da rade. Funkcija statičko pečenje emituje

toplota, i obezbeđuje ravnomerno spremanje hrane. To je idealno za pripremu kolača, torti, pečene testenine, lazanje i pice. Preporučuje se prethodno zagrevanje

rerne oko 10 minuta i najbolje se priprema kada se u ovoj funkciji koristi samo jedna polica.



Funkcija ventilatora:

Termostat i svetiljka za upozorenje na rerni će se uključiti, donji i gornji grejači i ventilator će početi da rade. Ova funkcija je

dobra za pečenje peciva. Pečenje se obavlja putem donjeg i gornjeg grejača u rerni i putem ventilatora koji omogućava cirkulaciju vazduha, što će omogućiti blagi efekat roštilja na hrani. Preporučuje se da prethodno zagrejte rernu oko 10 minuta.

4.3 TABELA ZA KUVANJE

Funkcija	Sudovi			
				min.
Statični	Lisnato testo	1 - 2	170-190	35-45
	Torta	1 - 2	170-190	30-40
	Kolačići	1 - 2	170-190	30-40
	Gulaš	2	175-200	40-50
	Piletina	1 - 2	200	45-60
Ventilator	Lisnato testo	1 - 2	170-190	25-35
	Torta	1 - 2 - 3	150-170	25-35
	Kolačići	1 - 2 - 3	150-170	25-35
	Gulaš	2	175-200	40-50
	Piletina	1 - 2	200	45-60

4.4

4.5 DODATNA OPREMA

Fioka rerne

Vaš uređaj ima fioku za čuvanje dodatne opreme kako što su poslužavnici, police, rešetke ili manje šerpe i tiganje.

UPOZORENJE: Unutrašnja površina fioke može postati vruća tokom upotrebe. Ne ostavljajte nikakvu hranu, plastiku ili zapaljive materijale u fioku.

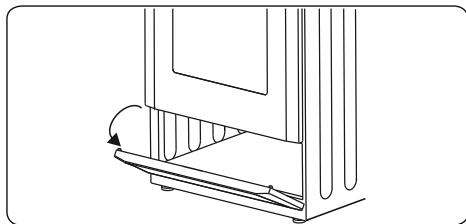

Plitki poslužavnik

Plitki poslužavnik je najbolje koristiti za pečenje peciva.

Postavite poslužavnik na bilo koju policu i gurnite do kraja da budete sigurni da je pravilno postavljen.

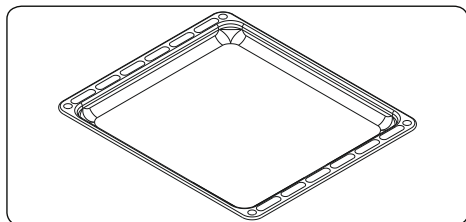

Žičana rešetka

Najbolje je koristiti žičanu rešetku za pripremu hrane u sudovima pogodnim za rerne.

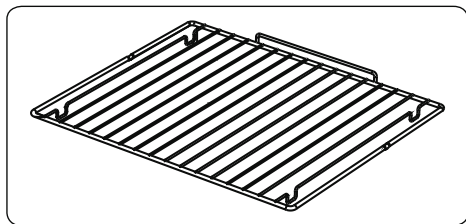

UPOZORENJE

Stavite rešetku na odgovarajuću policu u rerni i gurnite do kraja.

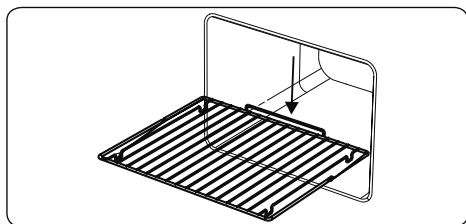

5. ČIŠĆENJE I ODRŽAVANJE

5.1 ČIŠĆENJE

UPOZORENJE: Isključite uređaj i ostavite da se ohladi pre čišćenja.

Opšta uputstva

- Pre nego što počnete da koristite sredstvo za čišćenje vašeg uređaja, proverite da li je prikladno i da li ga je preporučio proizvođač.
- Koristite kremasta ili tečna sredstva za čišćenje koja ne sadrže čestice. Ne koristite kaustične (korozivne) paste, abrazivna sredstva u prahu, čeličnu žicu ili tvrde alate za čišćenje jer mogu da oštete površine šporeta.

UPOZORENJE: Ne koristite sredstva za čišćenje koja sadrže čestice zato što mogu oštetiti površine od stakla, emajla i/ili boju na vašem uređaju.

• U slučaju da vam isteče bilo kakva tečnost, odmah očistite da ne bi došlo do oštećenja delova.

UPOZORENJE: Ne koristite paročistače za čišćenje bilo kog dela ovog uređaja.

Čišćenje unutrašnjosti rerne

- Unutrašnjost emajlirane rerne se najbolje čisti dok je rerna topla.
- Posle svake upotrebe obrišite rernu mekom krpom koja je natopljena sapunicom. Zatim, ponovo obrišite rernu vlažnom krpom i osušite je.
- Potrebno je povremeno koristiti tečna sredstva za čišćenje da bi se temeljno očistila rerna.

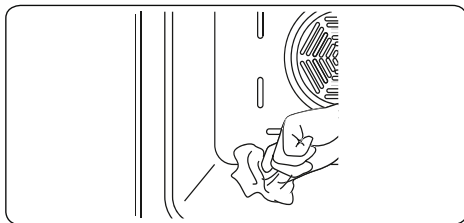

Čišćenje keramičkog stakla

Keramičko staklo može držati teško posuđe ali se može slomiti ako je udareno oštrim predmetom.

! **UPOZORENJE** : Keramička ploča za kuvanje - ako je površina naprsla, isključite uređaj da biste izbegli mogućnost strujnog udara.

- Koristite kremasta ili tečna sredstva za čišćenje vitrokeramičkog stakla. Zatim, isplaknite i osušite staklo temeljno suvom krpom.

 Nemojte koristiti materijale za čišćenje čelika jer mogu oštetiti staklo.

- Ako su u osnovi ili premazu posuđa korišćene površine sa niskom tačkom topljenja, iste mogu oštetiti staklokeramičku ploču za kuvanje. Ako plastika, aluminijumska folija, šećer ili šećerna hrana padnu na vruću staklokeramičku ploču za kuvanje, molimo da je što pre i što bezbednije ostružete sa vruće površine. Ako se ove supstance istope mogu oštetiti staklokeramičku ploču za kuvanje. Kada kuvate stvari sa puno šećera kao džem, ako je moguće stavite odgovarajuću posrednu zaštitnu podlogu.

- Prašina na površini mora biti očišćena vlažnom krpom.

- Bilo kakve promene boje keramičkog takla neće uticati na strukturu ili trajnost keramike i iste nisu rezultat promene materijala.

Promene boje keramičkog stakla mogu se javiti iz brojnih razloga:

1. Delovi hrane nisu očišćeni sa površine.
2. Upotreba nepravilnog posuđa na ploči za kuvanje može erodirati površinu.
3. Upotreba pogrešnih materijala za čišćenje.

Čišćenje staklenih delova

- Redovno čistite staklene delove vašeg uređaja.
- Koristite sredstvo za čišćenje stakla za unutrašnje i spoljašnje staklene delove. Zatim, isplaknite ih i osušite temeljno suvom krpom.

Čišćenje emajliranih delova

- Redovno čistite emajlirane delove vašeg uređaja.
- Brišite emajlirane delove mekom krpom koja je natopljena sapunicom. Zatim, obrišite ih ponovo vlažnom krpom i

osušite ih.

 Ne čistite emajlirane delove dok su još vrući od kuvanja.

 Nemojte da ostavljate sirće, kafu, mleko, so, vodu, sok od limuna ili paradajza u dodiru sa emajliranim delovima duže vremena.

Čišćenje delova od nerđajućeg čelika (ako ih ima)

- Redovno čistite delove vašeg uređaja koji su od nerđajućeg čelika.

- Obrišite delove od nerđajućeg čelika mekom krpom koja je natopljena samo vodom. Zatim ih osušite temeljno suvom krpom.

 Ne čistite delove od nerđajućeg čelika dok su još vrući od kuvanja.

 Nemojte da ostavljate sirće, kafu, mleko, so, vodu, sok od limuna ili paradajza u dodiru sa delovima od nerđajućeg čelika duže vremena.

Čišćenje ofarbanih površina (ako ih ima)

- Fleke od paradajza, paradajz sosa, kečapa, limuna, naftnih derivata, mleka, šećeraste hrane, šećerastih pića i kafe mogu se očititi odmah krpom umočenom u toplu vodu. Ako se ove fleke ne očiste i dopustite da se osuše na površinama gde su, nemojte ih ribati tvrdim predmetima (šiljastim predmetima, čeličnim ili plastičnim žicama za ribanje, sunderom za sudove koji oštećuje površine) ili čistiti sredstvima za čišćenje koja sadrže visoke nivoe alkohola, odmašćivače, abrazivne hemikalije za površine. U suprotnom se može javiti korozija na praškasto ofarbanim površinama i mogu se pojaviti fleke. Proizvođač nije odgovoran za bilo kakvu štetu izazvanu upotrebom neadekvatnih proizvoda za čišćenje ili metoda čišćenja.

Skidanje vrata rerne

Pre čišćenja staklenih vrata, morate ukloniti vrata rerne, kao što je prikazano na slici.

1. Otvorite vrata rerne.

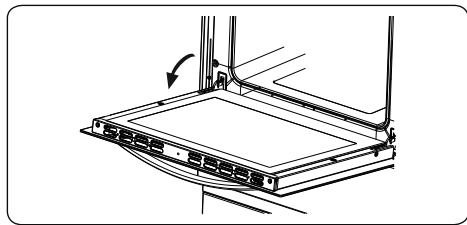

2. Otvorite šarku za zaključavanje (a) (uz pomoć šrafciĝera) do krajnjeg poloŝaja.

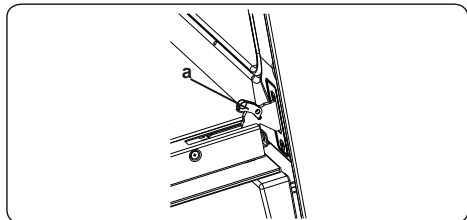

3. Zatvarajte vrata za dok ne dođu u poloŝaj da su skoro zatvorena i povucite vrata prema sebi da ih izvadite.

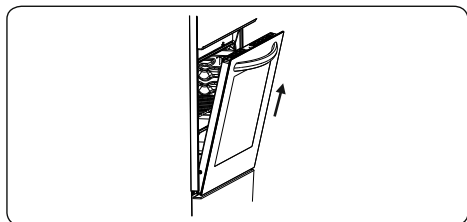

5.2 ODRŜAVANJE

! **UPOZORENJE:** Odrŝavanje ovog uređaja treba vrŝiti samo ovlaŝćeni serviser ili kvalifikovani elektriĉar.

Promena svetiljke rerne

! **UPOZORENJE:** Iskljuĉite uređaj i ostavite da se ohladi pre ĉišćenja.

- Izvadite stakleni poklopac, zatim izvadite i sijalicu.
- Stavite novu sijalicu (otpornu na 300 °C) da zamenite sijalicu koju ste izvadili (230 V, 15-25 Watt, tip E14).
- Vratite stakleni poklopac na mesto i moŝete koristiti rernu.
- Proizvod sadrŝi izvor svetlosti enerĝetske efikasnosti klase G.
- Krajni korisnik ne moŝe zameniti izvor svetlosti. Potrebna je usluga nakon prodaje.
- Ukljuĉeni izvor svjetlosti nije namijenjen za upotrebu u drugim aplikacijama.



! Svetiljka je projektovana specijalno za upotrebu u kuhinjskim aparatima. Nije pogodna za osvetljavanje prostorija u domaćinstvu.

6. REŠAVANJE PROBLEMA & TRANSPORT

6.1 REŠAVANJE PROBLEMA



Ako i dalje imate problem nakon što pređete ove osnovne korake za rešavanje problema, molimo vas da stupite u kontakt sa ovlašćenim serviserom ili kvalifikovanim tehničarom.

Problem	Mogući uzrok	Rešenje
Ne uključuje se ploča ili zona za kuvanje.	Nema napajanja.	Proverite osigurač uređaja u domaćinstvu. Proverite da li postoji prekid u napajanju zbog upotrebe drugih uređaja.
Rerna se ne uključuje.	Isključeno je napajanje.	Proverite da li uređaj ima napajanje. Proverite da li drugi kuhinjski uređaji rade.
Rerna se ne zagreva ili nedovoljno se zagreva,	Temperatura rerne nije pravilno podešena. Vrata rerne nisu zatvorena.	Proverite da li je kontrolno dugme za temperaturu rerne pravilno podešeno.
Hrana se ne peče ravnomerno u rerni.	Police rerne nisu pravilno postavljene.	Proverite da li koristite preporučenu temperaturu i položaj police. Ne otvarajte često vrata rerne osim ako pečete stvari koje treba okretati. Ako često otvarate vrata, unutrašnja temperatura može biti niža i ovo utiče na rezultate vašeg kuvanja.
Svetlo u rerni (ako ga ima) ne radi.	Pregorela je sijalica. Napajanje je prekinuto ili isključeno.	Zamenite sijalicu u skladu sa uputstvom. Proverite da li je napajanje uključeno u utičnicu.
Ventilator rerne (ako ga ima) bučno radi.	Vibriraju police u rerni.	Proverite da li je rerne ravna. Proverite da li police ili pribor za kuvanje vibriraju ili dodiruju zadnju ploču rerne.

6.2 TRANSPORT

Ako je potrebno da izvršite transport proizvoda, koristite originalnu ambalažu i nosite je u originalnom pakovanju. Pratite oznake za transport na ambalaži. Zalepite trakom sve posebne delove za proizvod da ne bi došlo do oštećenja prilikom transporta.

Ako ne čuvate originalnu ambalažu, pripremite kutiju za transport tako što je uređaj, a posebno njegove spoljašnje površine, zaštićen od spoljašnjih oštećenja.

7. TEHNIČKE SPECIFIKACIJE

7.1 ENERGETSKA KLASA





Marka		
Model		W-60.0
Tip ploče za kuvanje		Električna
Broj zona za kuvanje		4
Tehnologija grejanja 1		Radijantna
Veličina 1	cm	Ø14,5
Potrošnja energije 1	Wh/kg	192,0
Tehnologija grejanja 2		Radijantna
Veličina 2	cm	Ø14,5
Potrošnja energije 2	Wh/kg	192,0
Tehnologija grejanja 3		Radijantna
Veličina 3	cm	Ø18,0
Potrošnja energije 3	Wh/kg	192,0
Tehnologija grejanja 4		Radijantna
Veličina 4	cm	Ø18,0
Potrošnja energije 4	Wh/kg	192,0
Potrošnja energije kod ploče za kuvanje	Wh/kg	192,0
Ova ploča za kuvanje je u skladu sa EN 60350-2		
Saveti za uštedu energije		
Ploča za kuvanje		
- Koristite posuđe za kuvanje sa ravnim dnom.		
- Koristite posuđe za kuvanje odgovarajućih dimenzija.		
- Koristite posuđe za kuvanje sa poklopcem.		
- Smanjite količinu tečnosti ili masti.		
- Kada tečnost počne da ključa, smanjite temperaturu.		

Marka		
Model		W-60.0
Tip rerne		ELEKTRIČNA
Težina	kg	
Indeks energetske efikasnosti - standardna		105,7
Indeks energetske efikasnosti - sa ventilatorom		94,8
Energetska klasa		A
Potrošnja energije (struje) - standardna	kWh/ciklus	0,87
Potrošnja energije (struje) - sa ventilatorom	kWh/ciklus	0,78
Broj otvora		1
Izvor toplote		ELEKTRIČNA
Zapremina	l	65
Ova rerna je u skladu sa EN 60350-1		
<p>Saveti za uštedu energije</p> <p>Rerna</p> <ul style="list-style-type: none"> - Jela spremajte zajedno, ako je moguće. - Održavajte kratko vreme predzagrevanja. - Nemojte da produžavte vreme pečenja. - Nemojte da zaboravite da isključite rernu na kraju kuvanja. - Nemojte da otvarate vrata rerne tokom perioda kuvanja. 		

Thank you for choosing this product.

This User Manual contains important safety information and instructions on the operation and maintenance of your appliance.

Please take the time to read this User Manual before using your appliance and keep this book for future reference.

Icon	Type	Meaning
	WARNING	Serious injury or death risk
	RISK OF ELECTRIC SHOCK	Dangerous voltage risk
	FIRE	Warning; Risk of fire / flammable materials
	CAUTION	Injury or property damage risk
	IMPORTANT / NOTE	Operating the system correctly

CONTENTS

1.SAFETY INSTRUCTIONS.....	4
1.1 General Safety Warnings	4
1.2 Installation Warnings	7
1.3 During Use	7
1.4 During Cleaning and Maintenance	9
2.INSTALLATION AND PREPARATION FOR USE.....	10
2.1 Instructions for the Installer	10
2.2 Electrical Connection and Safety.....	11
2.3 Anti-tilting kit	12
2.4 Adjusting the feet	12
3.PRODUCT FEATURES.....	13
4.USE OF PRODUCT	14
4.1 Hob controls	14
4.2 Oven Controls.....	15
4.3 Cooking table.....	15
4.5 Accessories	15
5.CLEANING AND MAINTENANCE.....	16
5.1 Cleaning	16
5.2 Maintenance	18
6.TROUBLESHOOTING&TRANSPORT	19
6.1 Troubleshooting.....	19
6.2 Transport	19



1. SAFETY INSTRUCTIONS

- Carefully read all instructions before using your appliance and keep them in a convenient place for reference when necessary.
- This manual has been prepared for more than one model therefore your appliance may not have some of the features described within. For this reason, it is important to pay particular attention to any figures whilst reading the operating manual.

1.1 GENERAL SAFETY WARNINGS

- This appliance can be used by children aged from 8 years and above and by persons with reduced physical, sensory or mental capabilities or lack of experience and knowledge if they have been given supervision or instruction concerning use of the appliance in a safe way and understand the hazards involved. Children should not play with the appliance. Cleaning and user maintenance should not be made by children without supervision.

 **WARNING:** The appliance and its accessible parts become hot during use. Care should be taken to avoid touching heating elements. Keep children less than 8 years of age away unless they are continually supervised.

  **WARNING:** Unattended cooking on a hob with fat or oil can be dangerous and may result in fire. NEVER try to extinguish such a fire with water, but switch off the appliance and cover the flame with a lid or a fire blanket.

 **CAUTION:** The cooking process has to be supervised. A short term cooking process has to be supervised continuously

 **WARNING:** Danger of fire: Do not store items on the cooking surfaces.

 **WARNING:** If the surface is cracked, switch off the appliance to avoid the possibility of electric shock.

- For models which incorporate a hob lid, clean any spillages off the lid before use and allow the cooker to cool before closing the lid.
- Do not operate the appliance with an external timer or separate remote-control system.

 **WARNING:** To prevent the appliance tipping, the stabilising brackets must be installed. (For detailed information refer to the anti-tilting kit set guide.)

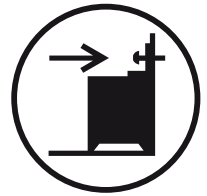

- During use the appliance will get hot. Care should be taken to avoid touching heating elements inside the oven.
- Handles may become hot after a short period of time during use.
- Do not use harsh abrasive cleaners or scourers to clean oven surfaces. They can scratch the surfaces which may result in shattering of the door glass or damage to surfaces.
- Do not use steam cleaners to clean the appliance.

 **WARNING:** To avoid the possibility of electric shocks, make sure that the appliance is switched off before replacing the lamp.

 **CAUTION:** Accessible parts may be hot when cooking or grilling. Keep young children away from the appliance when it is in use.

- Your appliance is produced in accordance with all

applicable local and international standards and regulations.

- Maintenance and repair work should only be carried out by authorised service technicians. Installation and repair work that is carried out by unauthorised technicians may be dangerous. Do not alter or modify the specifications of the appliance in any way. Inappropriate hob guards can cause accidents.
- Before connecting your appliance, make sure that the local distribution conditions (nature of the gas and gas pressure or electricity voltage and frequency) and the specifications of the appliance are compatible. The specifications for this appliance are stated on the label.

 **CAUTION:** This appliance is designed only for cooking food and is intended for indoor domestic household use only. It should not be used for any other purpose or in any other application, such as for non-domestic use, in a commercial environment or for heating a room.

- Do not use the oven door handles to lift or move the appliance.
- All possible measures have been taken to ensure your safety. Since the glass may break, care should be taken while cleaning to avoid scratching. Avoid hitting or knocking the glass with accessories.
- Make sure that the supply cord is not trapped or damaged during installation. If the supply cord is damaged, it must be replaced by the manufacturer, its service agent or similarly qualified persons in order to prevent a hazard.
- Do not let children climb on the oven door or sit on it while it is open.
- Please keep children and animals away from this

appliance.

1.2 INSTALLATION WARNINGS

- Do not operate the appliance before it is fully installed.
- The appliance must be installed by an authorised technician. The manufacturer is not responsible for any damage that might be caused by incorrect placement and installation by unauthorised people.
- When the appliance is unpacked, make sure that it has not been damaged during transportation. In the case of a defect, do not use the appliance and contact a qualified service agent immediately. The materials used for packaging (nylon, staplers, styrofoam, etc.) may be harmful to children and they should be collected and removed immediately.
- Protect your appliance from the atmosphere. Do not expose it to sun, rain, snow, dust or excessive humidity.
- Materials around the appliance (i.e. cabinets) must be able to withstand a minimum temperature of 100°C.
- The appliance must not be installed behind a decorative door, in order to avoid overheating.

1.3 DURING USE

- When you first use your oven you may notice a slight smell. This is perfectly normal and is caused by the insulation materials on the heater elements. We suggest that, before using your oven for the first time, you leave it empty and set it at maximum temperature for 45 minutes. Make sure that the environment in which the product is installed is well ventilated.

- Take care when opening the oven door during or after cooking. The hot steam from the oven may cause burns.
- Do not put flammable or combustible materials in or near the appliance when it is operating.
- Always use oven gloves to remove and replace food in the oven.
- Under no circumstances should the oven be lined with aluminium foil as overheating may occur.
- Do not place dishes or baking trays directly onto the base of the oven whilst cooking. The base becomes very hot and damage may be caused to the product.



Do not leave the cooker unattended when cooking with solid or liquid oils. They may catch fire under extreme heating conditions. Never pour water on to flames that are caused by oil, instead switch the cooker off and cover the pan with its lid or a fire blanket.

- Always position pans over the centre of the cooking zone, and turn the handles to a safe position so they cannot be knocked.
- If the product will not be used for a long period of time, turn the main control switch off. Turn the gas valve off when gas appliances are not in use.
- Make sure the appliance control knobs are always in the “0” (stop) position when the appliance is not in use.
- The trays incline when pulled out. Take care not to spill or drop hot food when removing it from the oven.
- Do not place anything on the oven door when it is open. This could unbalance the oven or damage the door.

- Do not place heavy or flammable items (e.g. nylon, plastic bags, paper, cloth, etc.) into the drawer. This includes cookware with plastic accessories (e.g. handles).

 **CAUTION:** The inside surface of the storage compartment may get hot when the appliance is in use. Avoid touching the inside surface.

- Do not hang towels, dishcloths or clothes from the appliance or its handles.

1.4 DURING CLEANING AND MAINTENANCE

- Make sure that your appliance is turned off at the mains before carrying out any cleaning or maintenance operations.
 - Do not remove the control knobs to clean the control panel.
 - To maintain the efficiency and safety of your appliance, we recommend you always use original spare parts and to call our authorised service agents when needed.
- CE Declaration of conformity**

 We declare that our products meet the applicable European Directives, Decisions and Regulations and the requirements listed in the standards referenced.

This appliance has been designed to be used only for home cooking. Any other use (such as heating a room) is improper and dangerous.

 The operating instructions apply to several models. You may notice differences between these instructions and your model.

2. INSTALLATION AND PREPARATION FOR USE

WARNING : This appliance must be installed by an authorised service person or qualified technician, according to the instructions in this guide and in compliance with the current local regulations.

- Incorrect installation may cause harm and damage, for which the manufacturer accepts no responsibility and the warranty will not be valid.
- Prior to installation, ensure that the local distribution conditions (electricity voltage and frequency and/or nature of the gas and gas pressure) and the adjustments of the appliance are compatible. The adjustment conditions for this appliance are stated on the label.
- The laws, ordinances, directives and standards in force in the country of use are to be followed (safety regulations, proper recycling in accordance with the regulations, etc.).

2.1 INSTRUCTIONS FOR THE INSTALLER

General instructions

- After removing the packaging material from the appliance and its accessories, ensure that the appliance is not damaged. If you suspect any damage, do not use it and contact an authorised service person or qualified technician immediately.
- Make sure that there are no flammable or combustible materials in the close vicinity, such as curtains, oil, cloth etc. which may catch fire.
- The worktop and furniture surrounding the appliance must be made of materials resistant to temperatures above 100°C.
- The appliance should not be installed directly above a dishwasher, fridge, freezer, washing machine or clothes dryer.
- The appliance can be placed close to other furniture on condition that, in the area where the appliance is set up, the furniture's height does not exceed the height of the cooktop.

Installation of the Cooker

- If the kitchen furniture is higher than the cooktop, the kitchen furniture must be at least 10 cm away from the sides of appliance for air circulation.
- If a cooker hood or cupboard is to be installed above the appliance, the safety distance between cooktop and any cupboard/cooker hood should be as shown below.

A (mm) Cupboard	420
B (mm) Cooker Hood	650/700
C (mm)	Product Width
D (mm)	50

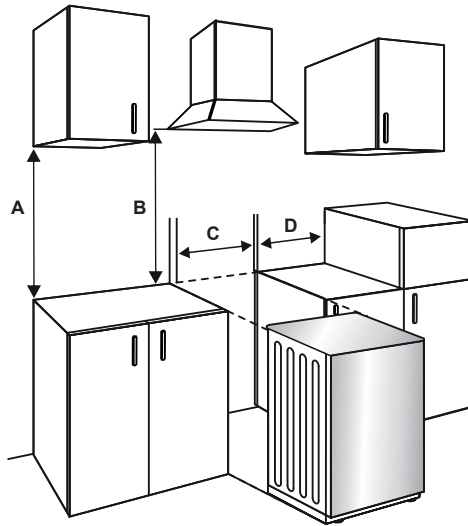

2.2 ELECTRICAL CONNECTION AND SAFETY

WARNING: The electrical connection of this appliance should be carried out by an authorised service person or qualified electrician, according to the instructions in this guide and in compliance with the current local regulations.

WARNING: THE APPLIANCE MUST BE EARTHED.

- Before connecting the appliance to the power supply, the voltage rating of the appliance (stamped on the appliance identification plate) must be checked for correspondence to the available mains supply voltage, and the mains electric wiring should be capable of handling the appliance's power rating (also indicated on the identification plate).
- During installation, please ensure that isolated cables are used. An incorrect connection could damage your appliance. If the mains cable is damaged and needs to be replaced this should be done by a qualified personnel.
- Do not use adaptors, multiple sockets and/or extension leads.
- The supply cord should be kept away from hot parts of the appliance and must not be bent or compressed. Otherwise the cord may be damaged, causing a short circuit.
- If the appliance is not connected to the mains with a plug, a all-pole disconnector (with at least 3 mm contact spacing) must be used in order to meet the safety regulations.
- The appliance is designed for a power supply of 220-240 V~.380-415 3N~. If your supply is different, contact the authorized service personnel or qualified electrician.
- The power cable (H05VV-F) must be long enough to be connected to the appliance.
- The fused switch must be easily accessible once the appliance has been installed.
- Ensure all connections are adequately tightened.
- Fix the supply cable in the cable clamp and then close the cover.
- The terminal box connection is placed on the terminal box.

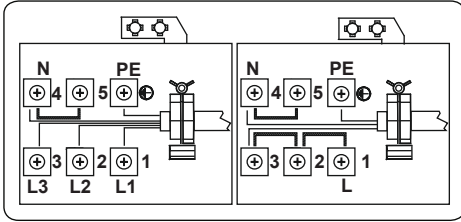

2.3 ANTI-TILTING KIT

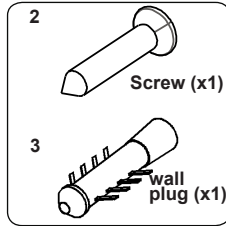

The document bag contains an anti-tilting kit. Loosely attach the anti-tilting bracket (1) to the wall using the screw (2) and wall plug (3), following the measurements shown in the figure and table below. Adjust the height of the anti-tilting bracket so that it lines up with the slot on the cooker and tighten the screw. Push the appliance towards the wall making sure that the anti-tilting bracket is inserted into the slot on the rear of the appliance.

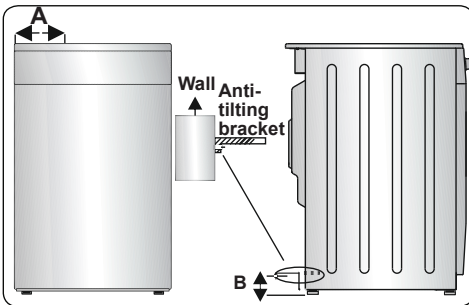

Product Dimensions (Width X Depth X Height) (Cm)	A (mm)	B (mm)
60x60x90 (Double Oven)	297.5	52
50x60x90 (Double Oven)	247.5	52
90x60x85	430	107
60x60x90	309.5	112
60x60x85	309.5	64
50x60x90	247.5	112
50x60x85	247.5	64
50x50x90	247.5	112
50x50x85	247.5	64

2.4 ADJUSTING THE FEET

Your product stands on four adjustable feet. For safe operation, it is important that your appliance is correctly balanced. Make sure the appliance is level prior to cooking. To increase the height of the appliance, turn the feet anti-clockwise. To decrease the height of the appliance, turn the feet clockwise.

It is possible to raise the height of the appliance up to 30 mm by adjusting the feet. The appliance is heavy and we recommend that a minimum of 2 people lift it. Never drag the appliance.

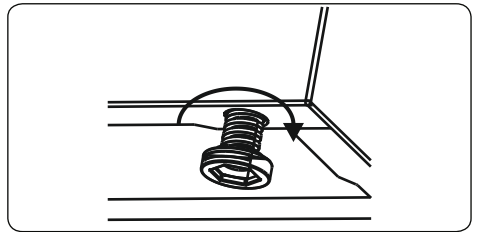

3. PRODUCT FEATURES



Important: Specifications for the product vary and the appearance of your appliance may differ from that shown in the figures below.

List of Components

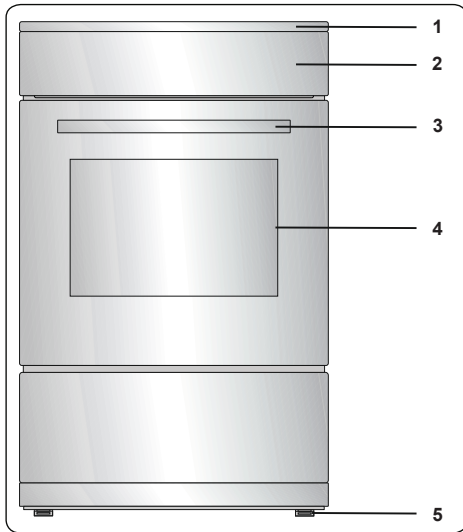

1. Cooktop
2. Control Panel
3. Oven Door Handle
4. Oven Door
5. Adjustable Feet

Control Panel

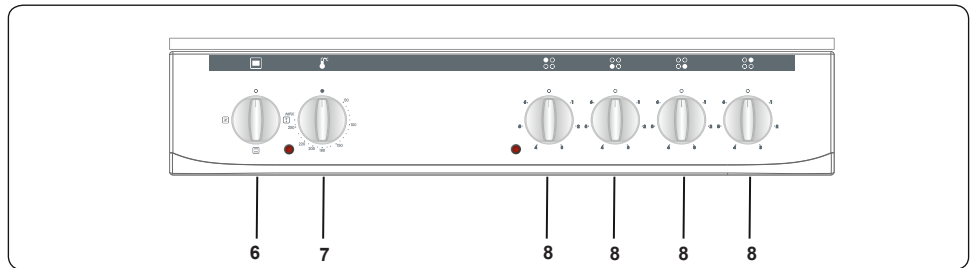

6. Oven Function Control Knob
7. Oven Thermostat Knob
8. Hob Control Knob

4. USE OF PRODUCT

4.1 HOB CONTROLS

Ceramic Heater

The ceramic heater is controlled by a 6 position knob.

The ceramic heater is operated by turning the control knob to the required setting. Near each control knob is a symbol which indicates the heater that is controlled by that knob. The on/off light on the control panel will show if any of the ceramic heaters are in use.

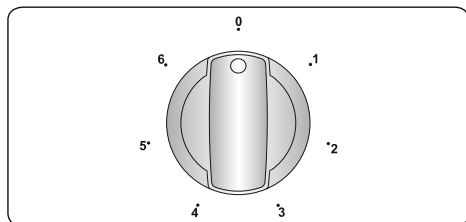

Knob Position	Function
0	Off position
1	Keep warm position
2-3	Heating position at low heat
4-5-6	Cooking, roasting and boiling position

 **Important:** The knob rotation direction may differ according to the product specification.

Dual and Oval Heaters (if available)

Dual and oval heaters have two heating zones. To activate the outer zone of a dual/oval heater, turn the knob to the ☉ position. Both outer zones will switch on.

To deactivate the outer zone of a dual/oval heater, turn the knob to the 'Off' position. Both outer zones will switch off.

Residual Heat Indicator (if available)

After using the hob there will be heat stored in the vitroceramic glass called residual heat. If the residual heat level is greater than +60°C, the residual heat indicator will be active for the cooking zone which is above this temperature.

If the power supply to the hob is disconnected while the residual heat indicator is on, the warning light will flash when the power is reconnected. The display will flash until the residual heat has

decreased or until one of the cooking zones is activated.

Hints and Tips

 **Important:** When ceramic heaters are operated in higher heat settings, the heated areas may be seen switching on and off. This is due to a safety device which prevents the glass from overheating. This is normal at high temperatures, causing no damage to the hob and little delay in cooking times.

WARNING:

- Never operate the hob without pans on the cooking zone.
- Use only flat saucepans with a sufficiently thick base.
- Make sure the bottom of the pan is dry before placing it on the hob.
- While the cooking zone is in operation, it is important to ensure that the pan is centred correctly above the zone.
- In order to conserve energy, never use a pan with a different diameter to the hotplate being used.

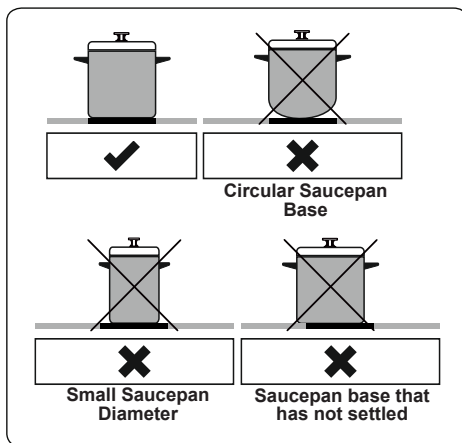

- Do not use pans with rough bottoms since these can scratch the glass ceramic surface.
- If possible, always place lids on the pans.
- The temperature of accessible parts may become high while the appliance is operating. Keep children and animals

well away from the hob during operation and until it has fully cooled after operation.

- If you notice a crack on the cooktop, it must be switched off immediately and replaced by authorised service personnel.

4.2 OVEN CONTROLS

Oven function control knob

Turn the knob to the corresponding symbol of the desired cooking function. For the details of different functions see 'Oven Functions'.

Oven thermostat knob

After selecting a cooking function, turn this knob to set the desired temperature. The oven thermostat light will illuminate whenever the thermostat is in operation to heat up the oven or maintain the temperature.

Oven Functions

* The functions of your oven may be different due to the model of your product.



Defrost Function: The oven's warning lights will switch on and the fan will start to operate. To use the defrost function, place your frozen food in the oven

on a shelf in the third slot from the bottom. It is recommended that you place an oven tray under the defrosting food to catch the water accumulated due to melting ice. This function will not cook or bake your food, it will only help to defrost it.



Static Cooking Function: The oven's thermostat and warning lights will switch on, and the lower and upper heating elements will start operating. The

static cooking function emits heat, ensuring even cooking of food. This is ideal for making pastries, cakes, baked pasta, lasagne and pizza. Preheating the oven for 10 minutes is recommended and it is best to use only one shelf at a time in this function.



Fan Function: The oven's thermostat and warning lights will switch on, and the

upper and lower heating elements and fan will start operating. This function is good for baking pastry. Cooking is carried out by the lower and upper heating elements within the oven and by the fan, which provides air circulation, giving a slightly grilled effect to the food. It is recommended that you preheat the oven for about 10 minutes.

4.3 COOKING TABLE

Function	Dishes			
Static	Puff Pastry	1 - 2	170-190	35-45
	Cake	1 - 2	170-190	30-40
	Cookie	1 - 2	170-190	30-40
	Stew	2	175-200	40-50
	Chicken	1 - 2	200	45-60
Fan	Puff Pastry	1 - 2	170-190	25-35
	Cake	1 - 2 - 3	150-170	25-35
	Cookie	1 - 2 - 3	150-170	25-35
	Stew	2	175-200	40-50
	Chicken	1 - 2	200	45-60

4.4

4.5 ACCESSORIES

The Flap Drawer

Your appliance includes a drawer for storing accessories such as trays, shelves, grids, or small pots and pans.



WARNING: The inner surface of the drawer may become hot during use.

Do not store any food, plastic or flammable materials in the drawer.

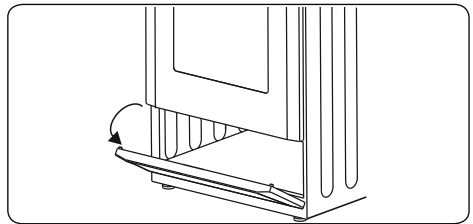

The Shallow Tray

The shallow tray is best used for baking pastries.

Put the tray into any rack and push it to the end to make sure it is correctly placed.

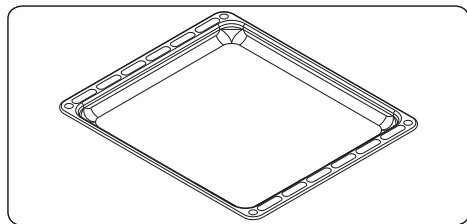

The Wire Grid

The wire grid is best used for grilling or for processing food in oven-friendly containers.

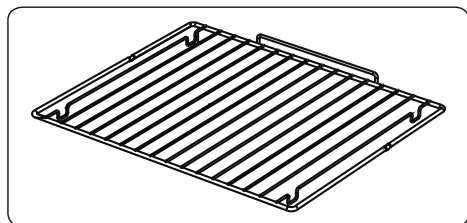

WARNING

Place the grid to any corresponding rack in the oven cavity correctly and push it to the end.

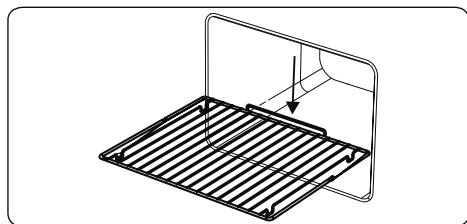

5. CLEANING AND MAINTENANCE

5.1 CLEANING

 **WARNING:** Switch off the appliance and allow it to cool before cleaning is to be carried out.

General Instructions

- Check whether the cleaning materials are appropriate and recommended by the manufacturer before use on your appliance.
- Use cream cleaners or liquid cleaners which do not contain particles. Do not use caustic (corrosive) creams, abrasive

cleaning powders, rough wire wool or hard tools as they may damage the cooker surfaces.

 Do not use cleaners that contain particles, as they may scratch the glass, enamelled and/or painted parts of your appliance.

- Should any liquids overflow, clean them immediately to avoid parts becoming damaged.

 Do not use steam cleaners for cleaning any part of the appliance.

Cleaning the Inside of the Oven

- The inside of enamelled ovens are best cleaned while the oven is warm.
- Wipe the oven with a soft cloth soaked in soapy water after each use. Then, wipe the oven over again with a wet cloth and dry it.
- You may need to use a liquid cleaning material occasionally to completely clean the oven.

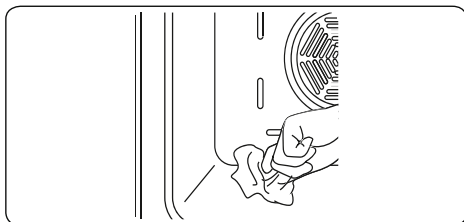

Cleaning the Ceramic Glass

Ceramic glass can hold heavy utensils but may be broken if it is hit with a sharp object.

 **WARNING :** Ceramic Cooktops - if the surface is cracked, to avoid the possibility of an electric shock, switch off the appliance and call for service.

- Use a cream or liquid cleaner to clean the vitroc ceramic glass. Then, rinse and dry the glass thoroughly with a dry cloth.

 Do not use cleaning materials meant for steel as they may damage the glass.

- If substances with a low melting point are used in the cookware's base or coatings, they can damage the glass-ceramic cooktop. If plastic, tin foil, sugar or sugary foods have fallen on the hot

glass-ceramic cooktop, please scrape it off the hot surface as quickly and as safely as possible. If these substances melt, they can damage the glass-ceramic cooktop. When you cook very sugary items like jam, apply a layer of a suitable protective agent beforehand if it is possible.

- Dust on the surface must be cleaned with a wet cloth.
- Any changes in colour to the ceramic glass will not affect the structure or durability of the ceramic and is not due to a change in the material.

Colour changes to the ceramic glass may be for a number of reasons:

1. Spilt food has not been cleaned off the surface.
2. Using incorrect dishes on the hob will erode the surface.
3. Using the wrong cleaning materials.

Cleaning the Glass Parts

- Clean the glass parts of your appliance on a regular basis.
- Use a glass cleaner to clean the inside and outside of the glass parts. Then, rinse and dry them thoroughly with a dry cloth.

Cleaning the Enamelled Parts

- Clean the enamelled parts of your appliance on a regular basis.
- Wipe the enamelled parts with a soft cloth soaked in soapy water. Then, wipe them over again with a wet cloth and dry them.



Do not clean the enamelled parts while they are still hot from cooking.



Do not leave vinegar, coffee, milk, salt, water, lemon or tomato juice on the enamel for a long time.

Cleaning the Stainless Steel Parts (if available)

- Clean the stainless steel parts of your appliance on a regular basis.
- Wipe the stainless steel parts with a soft cloth soaked in only water. Then, dry them thoroughly with a dry cloth.



Do not clean the stainless steel parts while they are still hot from cooking.



Do not leave vinegar, coffee, milk, salt, water, lemon or tomato juice on the

stainless steel for a long time.

Cleaning Painted Surfaces (if available)

- Spots of tomato, tomato paste, ketchup, lemon, oil derivatives, milk, sugary foods, sugary drinks and coffee should be cleaned with a cloth dipped in warm water immediately. If these stains are not cleaned and allowed to dry on the surfaces they are on, they should NOT be rubbed with hard objects (pointed objects, steel and plastic scouring wires, surface-damaging dish sponge) or cleaning agents containing high levels of alcohol, stain removers, degreasers, surface abrasive chemicals. Otherwise, corrosion may occur on the powder painted surfaces, and stains may occur. The manufacturer will not be held responsible for any damage caused by the use of inappropriate cleaning products or methods.

Removal of the Oven Door

Before cleaning the oven door glass, you must remove the oven door, as shown below.

1. Open the oven door.

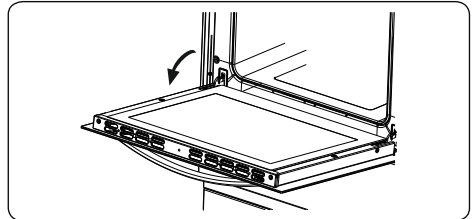

2. Open the locking catch (a) (with the aid of a screwdriver) up to the end position.

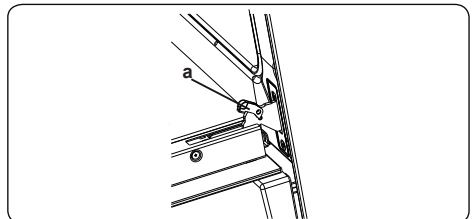

3. Close the door until it almost reaches the fully closed position and remove the door by pulling it towards you.

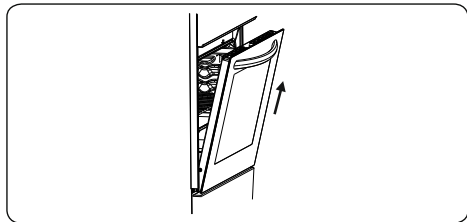

5.2 MAINTENANCE

! **WARNING:** The maintenance of this appliance should be carried out by an authorised service person or qualified technician only.

Changing the Oven Lamp

! **WARNING:** Switch off the appliance and allow it to cool before cleaning your appliance.

- Remove the glass lens, then remove the bulb.
- Insert the new bulb (resistant to 300 °C) to replace the bulb that you removed (230 V, 15-25 Watt, Type E14).
- Replace the glass lens, and your oven is ready for use.
- The product contains a light source of energy efficiency class G.
- Light source can not be replaced by end user. After sales service is needed.
- The included light source is not intended for use in other applications.

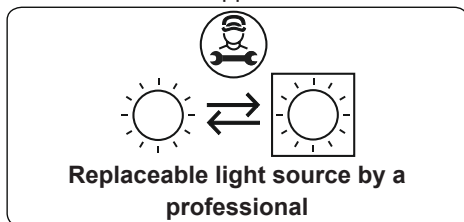

! The lamp is designed specifically for use in household cooking appliances. It is not suitable for household room illumination.

6. TROUBLESHOOTING&TRANSPORT

6.1 TROUBLESHOOTING



If you still have a problem with your appliance after checking these basic troubleshooting steps, please contact an authorised service person or qualified technician.

Problem	Possible Cause	Solution
The hob or cooking zones cannot be switched on.	There is no power supply.	Check the household fuse for the appliance. Check whether there is a power cut by trying other electronic appliances.
Oven does not switch on.	Power is switched off.	Check whether there is power supplied. Also check that other kitchen appliances are working.
No heat or oven does not warm up.	Oven temperature control is incorrectly set. Oven door has been left open.	Check that the oven temperature control knob is set correctly.
Cooking is uneven within the oven.	Oven shelves are incorrectly positioned.	Check that the recommended temperatures and shelf positions are being used. Do not frequently open the door unless you are cooking things that need to be turned. If you open the door often, the interior temperature will be lower and this may affect the results of your cooking.
Oven light (if available) does not operate.	Lamp has failed. Electrical supply is disconnected or switched off.	Replace lamp according to the instructions. Make sure the electrical supply is switched on at the wall socket outlet.
The oven fan (if available) is noisy.	Oven shelves are vibrating.	Check that the oven is level. Check that the shelves and any bake ware are not vibrating or in contact with the oven back panel.

6.2 TRANSPORT

If you need to transport the product, use the original product packaging and carry it using its original case. Follow the transport signs on the packaging. Tape all independent parts to the product to prevent damaging the product during transport.

If you do not have the original packaging, prepare a carriage box so that the appliance, especially the external surfaces of the product, is protected against external threats.



Ovaj dokument je originalno proizveden i objavljen od strane proizvođača, brenda Union, i preuzet je sa njihove zvanične stranice. S obzirom na ovu činjenicu, Tehnoteka ističe da ne preuzima odgovornost za tačnost, celovitost ili pouzdanost informacija, podataka, mišljenja, saveta ili izjava sadržanih u ovom dokumentu.

Napominjemo da Tehnoteka nema ovlašćenje da izvrši bilo kakve izmene ili dopune na ovom dokumentu, stoga nismo odgovorni za eventualne greške, propuste ili netačnosti koje se mogu naći unutar njega. Tehnoteka ne odgovara za štetu nanесenu korisnicima pri upotrebi netačnih podataka. Ukoliko imate dodatna pitanja o proizvodu, ljubazno vas molimo da kontaktirate direktno proizvođača kako biste dobili sve detaljne informacije.

Za najnovije informacije o ceni, dostupnim akcijama i tehničkim karakteristikama proizvoda koji se pominje u ovom dokumentu, molimo posetite našu stranicu klikom na sledeći link:

<https://tehnoteka.rs/p/union-elektricni-sporet-w-600-akcija-cena/>