

Uputstvo za upotrebu

AENO panelni radijator AGH0002S beli

A E N O

Tehnoteka je online destinacija za upoređivanje cena i karakteristika bele tehnike, potrošačke elektronike i IT uređaja kod trgovinskih lanaca i internet prodavnica u Srbiji. Naša stranica vam omogućava da istražite najnovije informacije, detaljne karakteristike i konkurentne cene proizvoda.

Posetite nas i uživajte u ekskluzivnom iskustvu pametne kupovine klikom na link:

<https://tehnoteka.rs/p/aeno-panelni-radijator-agh0002s-beli-akcija-cena/>

A E N O



reddot winner 2023
smart product



AENO™ Premium Eco Smart Heater Installation and Operation Manual

Models: AGH0001S (-IT, -CH, -UK, -SA), AGH0002S (-IT, -CH, -UK, -SA), AGH0003S (-IT, -CH, -UK, -SA), AGH0004S (-IT, -CH, -UK, -SA), AGH0005S (-IT, -CH, -UK, -SA)

(including the above models with "-A" ending)

Introduction

AENO™ heater is designed for heating residential and office spaces.

The present Manual contains a detailed description of the device, as well as instructions for its installation and operation.

Copyrights

Copyright of ©ASBISc Enterprises PLC. All rights reserved.

The AENO™ trademark is owned by ASBIS GROUP OF COMPANIES (hereinafter referred to as the ASBIS). All other similar trademarks and names, as well as logos and other symbols are the property of their respective owners*.

All materials under AENO™ tradename contained therein are protected in accordance with international and local laws including Acts on Copyrights and related rights.

Any reproduction, copying, publication, as well as further distribution or public display of material contained in the present document (whether in full or in part) shall not be allowed until an appropriate permission of the copyright owner is obtained.

Any unauthorized usage of materials contained herein may lead to civil liability and criminal prosecution in accordance with applicable laws.

Any eventual mentioning of other company names and equipment in the present document is made solely for the purpose of clarifying and describing the device operation and shall not infringe on the third party's intellectual property rights.

* Google Play and Google Home are trademarks of Google Inc.; App Store is the registered trademarks of Apple Inc.; Yandex is the registered trademark of YANDEX LLC.; Amazon Alexa is the registered trademark of Amazon Technologies, Inc.

Responsibility and Technical Support

This document was prepared in accordance with all necessary legal requirements and contains detailed and complete information on operation and maintenance of the device. The information is current as of the date indicated in this document. Strict adherence to the instructions in this manual will ensure correct, safe and reliable operation of the device.

Both this manual and the Quick Start Guide are an integral part of the device and should always be available to the user for reference.

ASBIS reserves the right to modify the device and make corrections or changes to this document without prior notice of the user, and shall not be responsible for any potential negative consequences which may arise from the use of an outdated version of the document, as well as for any possible technical and/or typographical errors, either omitted or accidental, or any related damage that may result from the document transfer or the use of the devices.

In case of any discrepancies between language versions of this document, the Russian version of this User Manual shall prevail.

ASBIS shall make no guarantee with respect to any data contained herein including but not limited to the device merchantability and fitness for a particular purpose.

If you have any technical questions, please contact your local ASBIS representative or the technical support department at aeno.com. The most common issues are described in Section 7 (Troubleshooting) of this document.

Please visit aeno.com/documents to download the latest version of this manual.

User information including personal data is protected from unauthorized access and disclosure in accordance with GDPR requirements. You can read the Privacy Policy at aeno.com/privacy-policy.

Conformance to Standards



The device is CE certified and complies with requirements of the following Directives of the European Union:

- 2014/35/EU Low Voltage Directive;
- 2004/30/EU Electromagnetic Compatibility Directive;
- 2014/53/EU Radio Equipment Directive;
- 2009/125/EU Ecodesign Directive.

Tested by TUV NORD in accordance with Directive 2014/35/EU.



The device complies with the UKCA marking requirements for selling the device in the UK



The device has passed all procedures of assessments established in Technical Regulations of the Customs Union and conforms with standards of the Customs Union



The device complies with the requirements of Restriction of the Use of Certain Hazardous Substances (RoHS) in Electronic and Electrical Equipment (2011/65/EU Directive) including requirements of 2015/863/EU Directive



The national conformity mark of the Ukraine indicating that the device meets requirements of all applicable technical regulations



The crossed-out trash can symbol is used to label electrical and electronic equipment, and indicates its separate collection.

The symbol is given in accordance with the Directive 2012/19/EU on Waste Electrical and Electronic Equipment (WEEE) and indicates that this equipment requires separate collection at the end of its life and must be disposed of separately from unsorted household waste.

To protect the environment and human health, please dispose of used electrical and electronic equipment according to approved safe disposal guidelines

	AT	BA	BE	BG	CH	CZ	CY	DE	DK	EE	ES
	FI	FR	GR	HR	HU	IE	IT	KZ	LT	LV	LU
	MT	NL	NO	PL	PT	RO	RS	SE	SK	SL	UK

Simplified Declaration of Conformity

ASBISc hereby declares that the device described in the present document complies with Directive 2014/53/EU. The full text of the Declaration of Conformity can be found at the following address: aeno.com/userfiles/files/Certificates/CE/Heater.pdf.

Limitations and Warnings

Prior to installation and operation of the device, the User shall carefully read and understand information contained herein.

WARNING!

Do not cover the heater to avoid overheating.

WARNING!

Do not install the heater directly under a plug socket.

WARNING!

Do not use the heater if the glass panels are damaged.

ATTENTION!

The warnings, precautions, and instructions contained in this document may not contain every possible hazardous situation. Use common sense when using the device.

Warning symbols and icons



Hot surface. The risk of burns in the case of contact with heated surfaces. Do not touch heating panel until completely cooled down and do not allow the power cable to contact the heating panel



To avoid overheating, do not cover the device or dry clothes on it



The device is intended for indoor use only

IP44

Degree of protection of the device casing that is protection against the ingress of solid objects larger than 1 mm in size, as well as drops and splashes falling from any angle



General warning icon



The device is Class II for protection against electric shock (double insulation)



Do not repair the device on your own as this may result in electric shock or other injury and will void the manufacturer's warranty



Do not expose the device to liquids



The eco-label symbol on the package indicating its recyclability



Recyclable corrugated cardboard packaging



No moving parts in the design of the device prevents the formation of dust



Indication that the device may be broken or damaged if not handled carefully



Indication that the device must be protected from moisture



Toxic substances are not available in the materials from which the device is made



Function of maintaining the set temperature (for remote control)



The device is certified according to the standards applicable in the countries of sale



Packaging is RoHS & REACH compliant and contains no prohibited materials



Innovative design



Producer of raw materials for packaging was certified by the Forest Stewardship Council (FSC™)



Producer of raw materials for making packaging confirms responsible forest management

Safety Operation Rules

1. Please read these instructions carefully. The device shall be installed and used as described in this manual only. Any other use not specified therein may cause fire and other hazards, as well as injury to persons.
2. The device is intended for operation in a room with an ambient temperature of 0 °C... +40 °C.
3. The device is not intended for use in explosive, commercial, industrial or agricultural areas and facilities – it may only be used in residential areas as an additional source of heating.
4. During operation of the device, its power cord plug shall always fit tightly into the outlet, otherwise it may lead to overheating of the outlet.
5. Keep children and pets away from the area of installation of the Eco Smart Heater, as contact with the device in operation may result in burns.
6. The device may only be operated when it is properly mounted on brackets or special legs as supplied within the scope of delivery.
7. The included hooks and dowels are designed to mount the unit on a reinforced concrete wall only. When installing on another type of wall, you should choose the appropriate fasteners that are suitable for both the wall and the device weight of more than 10 kg. The manufacturer shall not be liable for any damage resulting from the use of unsuitable fasteners.
8. The installation area shall be level, i.e. without any bends or warps (flat vertical or horizontal surface). If the device is in the wrong position when connected to the source of power, it will emit short beeps.
9. Do not bend the device or otherwise use force for wall installation using screws.
10. When moving the device, you may only hold it by brackets on its back. Do not move the device by the glass panel while it is switched on or hot.
11. If the device is connected to the mains, it is strongly recommended to ensure quick and easy way to disconnect it from the source of power.
12. **Do not mount the device directly under or on top of an electrical socket!**
13. **Do not allow the power cable to come into contact with the heating panel!**
14. To avoid supply network overloading and the risk of fire, do not use an extension cord to connect the device to the power source, or connect the device to the mains socket along with other household appliances.
15. Do not touch the heating panel during operation of the device.
16. The power cord must not touch the heat-radiant panel. Do not cover the power cord with rugs, runners, or similar coverings, or run it under furniture or appliances, or where you can fall over it.
17. Do not use the device in the case of damage or cracks, or any signs of damage to any other parts thereof, e.g. the power cable.

18. If the power cable is damaged, it may only be replaced by an authorized service center or other authorized party.
19. Do not drop, throw, disassemble or attempt to repair the device on your own. Stop using the device, it is has fallen.
20. Do not expose the device to direct sunlight or moisture, oils, chemical or other organic liquids, or vibrations.
21. Do not use the device in a combustible, explosive and/or dusty environment, as well as in areas where corrosion of its materials is possible.
22. Never place the heater in areas where it could fall into a bathtub or other container of water.
23. Do not dry clothes or any other items with the device, and do not place it less than 1 meter away from any fabrics, decorative objects or other flammable objects. **WARNING!** Violation of these recommendations is at the user's risk, and the manufacturer shall not be liable for any damages resulting from this violation.
24. The device shall be operated at least 1.5 meters away from people and animals.
25. **Do not operate the device on carpets and heated floors!**
26. If the device is not used (heating mode switched off) for a long period of time, it shall be disconnected from the source of power.
27. To avoid an unpleasant "burnt" smell, it is recommended to keep the device clean and free of dust accumulation.
28. To clean the device, use a water-dampened cotton cloth followed by a dry streak-free cloth cleaning. Do not clean the device until it is switched off and de-energized. Do not use cleaning agents or detergents to clean the device.
29. The device is not intended for use by children under 12 years, or by persons of limited physical, sensory or mental capabilities who have no adequate experience or knowledge in using the device, unless they are supervised or instructed by a person responsible for their safety.
30. Do not use the device in areas with people who are unable to leave the room on their own or who are not under the constant supervision of a person responsible for their safety.

WARNING!

Any damage to the device as a result overturning or falling will void the manufacturer's warranty.

For any issues on installation, configuration or operation of AENO devices, please contact our technical support team at support@aeno.com or fill out the form at aeno.com/service-and-warranty

Table of Contents

Introduction.....	3
Copyrights	3
Responsibility and Technical Support.....	4
Conformance to Standards.....	5
Simplified Declaration of Conformity	6
Limitations and Warnings	6
Table of Contents.....	10
1 General Description and Specifications.....	12
1.1 General Purpose	12
1.2 AGH0001S-AGH0002S Model Appearance	13
1.3 AGH0003S-AGH0005S Model Appearance	15
1.4 Button Functions and Indication	17
1.5 Venting Hole	18
1.6 Types of Electrical Outlets and Plugs.....	19
1.7 Technical Specifications.....	20
1.8 Scope of Delivery	21
1.9 Packaging and Labeling	24
1.9.1 Labeling Rules and the Date of Manufacture.....	24
1.10 Space Heating Technologies.....	25
2 Installation and Operation.....	27
2.1 First Installation and Setup.....	28
2.1.1 Unpacking and Preparing for Installation/Mounting.....	29
2.1.2 Preparing the Installation area	29
2.1.3 Floor Installation (Option 1).....	30
2.1.4 Horizontal Wall Mounting (Option 2).....	33
2.1.5 Vertical Wall Mounting (Option 3).....	36
2.1.6 Wall Mounting with 4 Hooks (Additional Fixation).....	39
2.1.7 Hardwiring Option	40
2.1.8 Ceiling Mounting	40
2.2 Initial Power On.....	41
2.3 Manual Control.....	42
2.3.1 Instructions for AGH0001S-AGH0002S Models.....	42
2.3.2 Instructions for AGH0003S-AGH0005S Models.....	43
2.4 Remote Control via the AENO App.....	44
2.4.1 App Installation.....	44
2.4.2 Registering a New Account.....	44
2.4.3 Logging into an Existing Account.....	45
2.4.4 Eco Smart Heater Activation Process	45
2.4.5 Control Panel of the Eco Heater	50

2.4.6 Operating Mode Selection.....	50
2.4.7 Setting the Heater Schedule.....	51
2.4.8 Setting the Countdown Timer.....	53
2.4.9 Energy and Power Statistics	53
2.4.10 Changing Settings.....	54
2.4.11 Additional Settings	55
2.4.12 Scenarios and Automations.....	58
2.5 Child Lock Mode	63
2.6 Adjusting and Turning Off the Buttons LEDs.....	64
2.7 Remote Control Via Voice Assistants	64
3 Maintenance and Repair	65
4 Warranty Obligations.....	66
4.1 AENO™ Service Centers	67
4.2 Warranty Service Procedure	67
4.3 Limitation of Liability	67
5 Storage, Transportation and Disposal of Devices	69
6 Other Information.....	71
7 Troubleshooting	72
8 Glossary.....	74

Figures and Tables

Figure 1 – Appearance (AGH0001S-AGH0002S)	13
Figure 2 – Buttons, ports and indicators (AGH0001S-AGH0002S).....	14
Figure 3 – Appearance (AGH0003S-AGH0005S).....	15
Figure 4 – Buttons, ports and indicators (AGH0003S-AGH0005S).....	16
Figure 5 – Package contents.....	23
Figure 5 – Examples of heater installation*	28
Figure 6 – Mounting on legs (on the floor).....	30
Figure 7 – Installation of the brackets.....	34
Figure 8 – Preparing of the wall (horizontal mounting).....	35
Figure 9 – Preparing the wall (vertical mounting)	37
Figure 10 – Vertical installation (wall mounting).....	38
Table 1 – Power button functions.....	17
Table 2 – Power button LED indication.....	17
Table 3 – Additional button functions (AGH0003S-AGH0005S)	18
Table 4 – Basic Technical Specifications.....	20
Table 5 – Typical problems and solutions.....	72

1 General Description and Specifications

1.1 General Purpose

The AENO™ heater is an electric heating device with a combined heat output designed for primary, supplementary and local heating of domestic and other premises (apartments, offices, trade enterprises, gyms, educational institutions, catering enterprises, etc.).

Key benefits of the heater AENO™ are as follows:

- Combined infrared and convection heating;
- Connection via Wi-Fi (2.4 GHz);
- Low power consumption;
- Automatic maintenance of desired temperature in the room;
- Ability to set the maximum temperature of the heating panel;
- Electronic thermostat and tilting sensor;
- Large heat-emitting surface area;
- Possibility of leg installation, as well as horizontal or vertical wall mounting;
- Option to mount the device on the ceiling (It is available only after connecting the device to the mobile app);
- Low dust content in the air due to lower convection (thermal movement of air volumes);
- Remote control via a mobile app or voice assistants, as well as manual control;
- Noiseless operation;
- Comfortable microclimate in the room;
- Installation of legs and brackets without tools;
- Elegant glass surface;
- The use of non-toxic materials in production;
- Minimum size of the control unit and matching accessories with the color of the heating panel;
- Winner of the two prestigious Red Dot Design Awards.

Here and further below, any reference to AGH0001S-AGH0002S models means all configurations of such two models, and AGH0003S-AGH0005S means all configurations of such three models (See par. 1.9.1 below).

1.2 AGH0001S-AGH0002S Model Appearance



Figure 1 – Appearance (AGH0001S-AGH0002S)

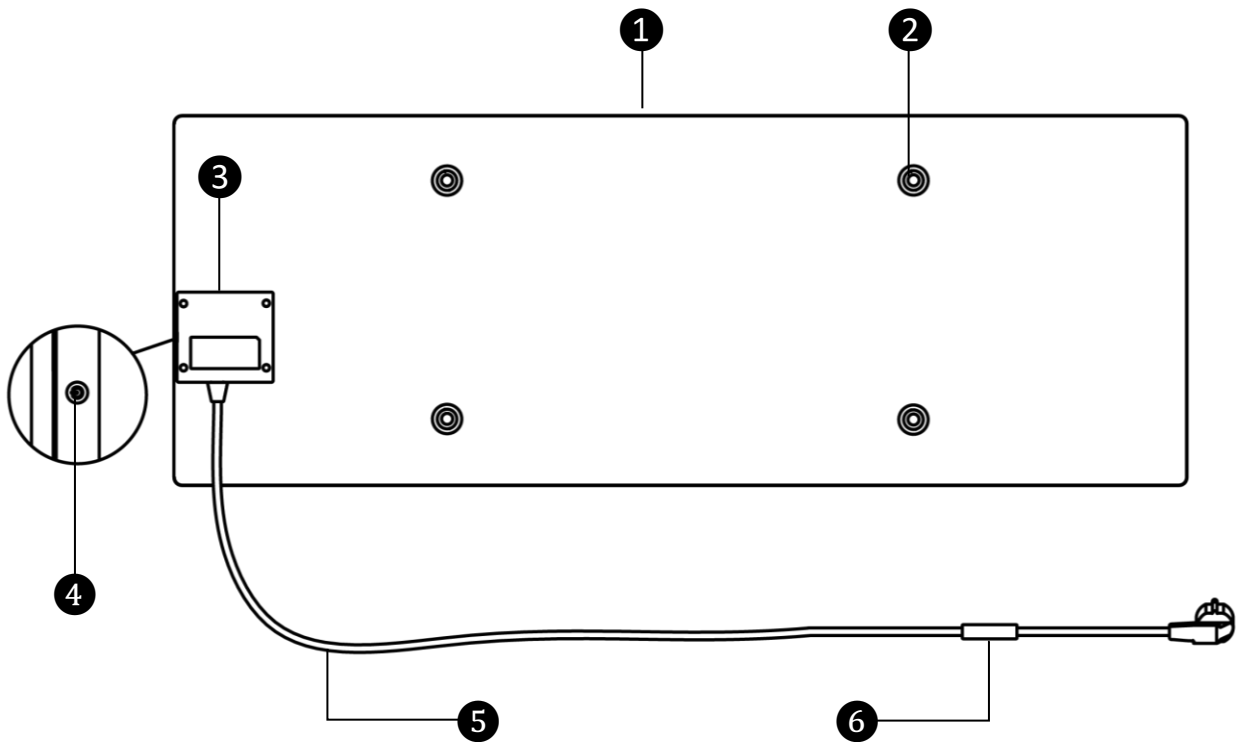

Figure 2 – Buttons, ports and indicators (AGH0001S-AGH0002S)

1	Heating panel of the device that is emitting heat to warm the room
2	Hole in the panel for a mounting bolt for screwing legs or wall brackets
3	Electronic module for the heater control which includes a signaling component (piezo siren) to audibly notify users of the device statuses
4	LED button for switch the heating mode on and off
5	Power cable to connect the heater to the mains socket
6	Sensor that measures the ambient air temperature and ensures accuracy when maintaining the required heating temperature

1.3 AGH0003S-AGH0005S Model Appearance



Figure 3 – Appearance (AGH0003S-AGH0005S)

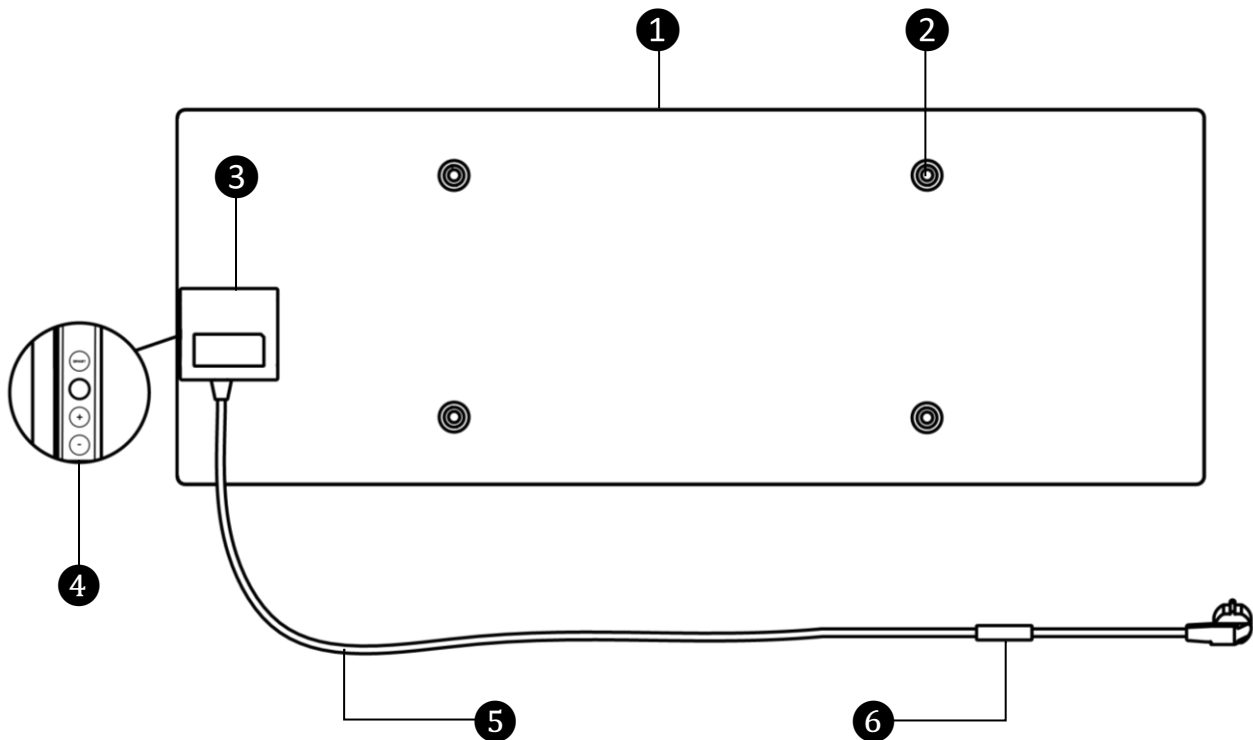
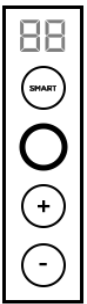

Figure 4 – Buttons, ports and indicators (AGH0003S-AGH0005S)

1	Heating panel of the device that is emitting heat to warm the room
2	Hole in the panel for a mounting bolt for screwing legs or wall brackets
3	Electronic module for the heater control which includes a signaling component (piezo siren) to audibly notify users of the device statuses
4	<div style="display: flex; align-items: center;">  <div> <p>Control panel consisting of the following buttons (from top to bottom):</p> <ul style="list-style-type: none"> • LED display; • SMART mode button; • Power button; • Temperature increase button; • Temperature decrease button. </div> </div>
5	Power cable to connect the heater to the mains socket
6	Sensor that measures the ambient air temperature and ensures accuracy when maintaining the required heating temperature

1.4 Button Functions and Indication

Table 1 – Power button functions

Action	Description
Press and hold the power button for no more than 3 seconds	Switching the device from Off to On mode and vice versa
Press and hold the power button for more than 3 seconds	Resetting the fault condition (blinking red) and switching to the Off mode
Press and hold the power button for 4 to 10 seconds	Switching to activation mode in the AENO mobile app
Press and hold the power button for more than 10 seconds	Factory reset
Press the power button 5 times in 4 seconds	Manual disabling of the Child Lock mode

Table 2 – Power button LED indication

Color	Status	Description
Blue	On	The device is connected to the mains and activated in the mobile app, but the heating mode is switched off
	Flickering	The device is connected to the mains, but not activated in the mobile app, and heating mode is switched off
Green	On	The device is connected to the mains and activated in the mobile app, and the heating mode is switched on
	Flickering	The device is connected to the mains, but not activated in the mobile app, and heating mode is switched on
Purple	Blinking fast	The device is connected to the mains, and the process of activation in the mobile app was started
Red	Blinking	The device is connected to the mains, but an error has occurred (Incorrect orientation, safety mechanism actuation, etc.)
	Blinking fast (3 times)	Factory reset process was initiated

Color	Status	Description
Yellow	On	The device is connected to the mains, and the temperature maintenance mode is on (for remote control via the mobile app only)
	Off	The device is not connected to the mains, or a power failure occurred

Blinking means that the LED is on for 500 ms, and then is off for 500 ms.

Blinking fast means that the LED is on for 100 ms, and then is off for 100 ms.

Flickering means that the LED is on for 3,000 ms, and then is off for 300 ms.

Table 3 – Additional button functions (AGH0003S-AGH0005S)

Button	Action	Description
SMART mode button	Single press	SMART mode enabling or disabling
Temperature increase button	Single press	Increase the desired room temperature by 1 °C
Temperature decrease button	Single press	Decrease the desired room temperature by 1 °C

1.5 Venting Hole

The venting hole in the heater body is required to ensure proper air circulation and is not a defect in the device.

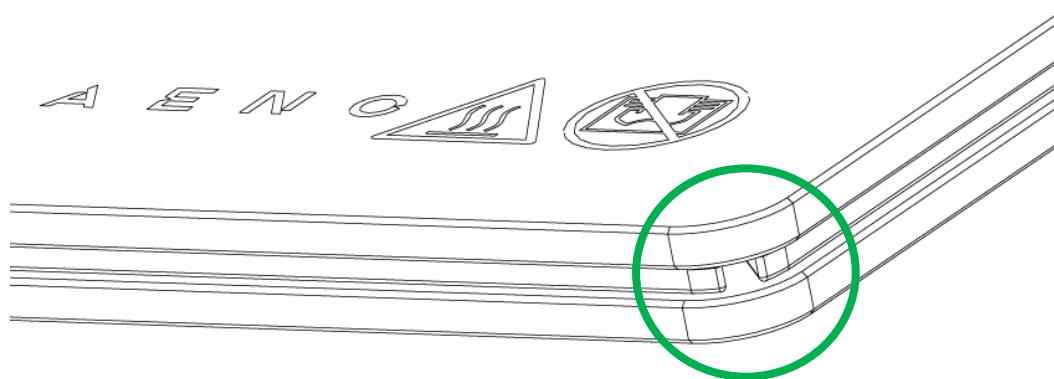





Its location may differ for some models of heaters.

WARNING!

It is forbidden to block the venting hole of the device.

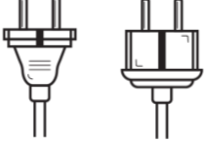
1.6 Types of Electrical Outlets and Plugs

Since electrical outlet standards may vary from country to country, there are several versions of the AENO™ heater plugs depending on the country of sale.

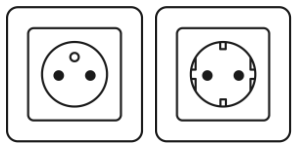
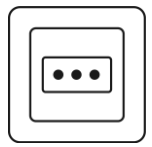
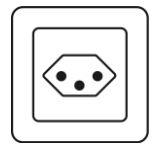
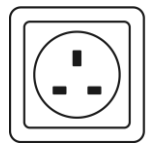
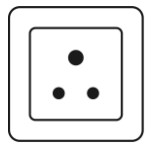
(without ending)	-IT	-CH	-UK	-SA
Plug type E/F: 	Plug type L: 	Plug type J: 	Plug type G: 	Plug type M: 
For E, F outlets: 	For L outlets: 	For J outlets: 	For G outlets: 	For M outlets: 
Voltage: 230 V, Frequency: 50 Hz				

Before using the device, please make sure that the power cord plug is compatible with the user's electrical outlet.

If for any reason, the user purchased the device with an incompatible plug, then a suitable adapter must be used for connecting it to the mains (not included in the delivery).

NOTE

Advice on purchasing the required adapter can be obtained from any electrical store, or from our technical support service at support@aeno.com

Also, before using the device, please make sure that the power plug does not fall out of the user's electrical outlet and is also securely fixed in it.

ATTENTION!

Do not use the device if the power plug is not firmly seated in the outlet, as this may cause the outlet to overheat, and risk a fire may occur.

ATTENTION!

Questions and/or issues with electrical outlets should only be handled by a qualified electrician. Do not use excessive force when inserting the plug into the outlet, and do not attempt to repair/modify the outlet or the plug on your own.

1.7 Technical Specifications

Table 4 – Basic Technical Specifications

Parameter	Value
Model	AGH0001S – AGH0005S (See sub-par. 1.9.1 below)
Communication Standard	Wi-Fi (IEEE 802.11b/g/n), <20 dBm (~100 mW))
Operating frequency	2,400-2,483.5 GHz
Integration	Google Assistant, Amazon Alexa
Server	Cloud
Type of heater	Micathermic, double-sided
Heating types	Infrared radiation – 75 % Convection – 25 %
IR angle	Up to 300° (depending on installation area)
IR wavelength	95-100 μm
Room area	30 m ² max (depends on the room insulation)
Allowable temperature adjustment range for the heating panel	60 °C to +120 °C
Power	Power supply voltage: 220V to 230 V (AC), 50 Hz Permissible voltage range: 180-253 V (AC) Rated current: 3.0 A (no more than 0.01 A in standby mode) Rated power: 700 W (for AGH0001S-AGH0002S models) 760 W (for AGH0003S-AGH0005S models) (not more than 2 W in standby mode)
Types of protection	Current protection: 6.3 A Voltage protection: 260 V Panel temperature protection: +135 °C
Protection Class	IP44

Parameter	Value
Electronic gyroscope	Tip-over shutdown
Operating temperature	0 °C to +40 °C
Operating humidity	up to 75 % RH (without condensation)
Storage temperature	-20 °C to +70 °C
Storage humidity	up to 75 % RH (without condensation)
Installation options	On a flat horizontal surface (horizontal floor installation, ceiling mounting). On a flat vertical surface (horizontal or vertical wall mounting). Designed for indoor installation only.
Case Material	Heating plate: tempered glass Control unit: PC plastic
Color	Glossy White Pearl Black Noble Gray
Dimensions (L × W × H)	1000×165×417 mm (floor installation) 1000×62×365 mm (wall mounting)
Net Weight	8.7 kg (with accessories)
Warranty period	3 years
Service life	3 years
Certificates	CE, EAC, RoHS
International Red Dot Design Award (AGH0001S-AGH0002S)	List of awards: 1. Heating and air conditioning technologies. 2. Smart product

1.8 Scope of Delivery

The AENO™ heater comes with the following devices and accessories:

1. Premium Eco Smart Heater AENO™ – 1 pc.
2. Legs for floor installation – 2 pcs.

3. Brackets for wall mounting
(assembled with the heater, or separately) – 2 pcs.
4. Mounting kit, namely:
mounting bolts – 4 pcs.
hooks – 4 pcs.
dowels – 4 pcs.
5. Template for drilling holes in the wall – 1 pc.
6. Quick Start Guide – 1 pc.
7. Warranty Card – 1 pc.



1 – Heater

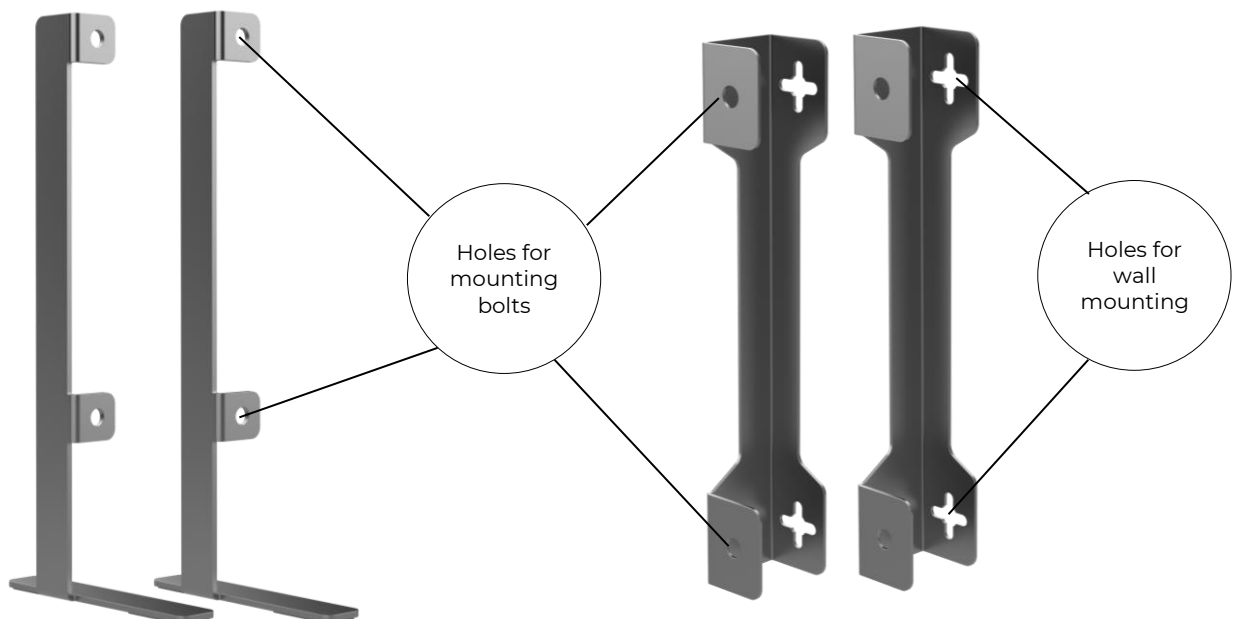

2 – Leg for floor installation*



3 – Bracket for wall mounting*

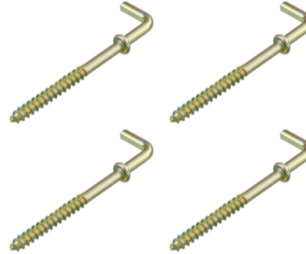

4(a) – Mounting bolts*

4(b) – Screws*

4(c) – Dowels*

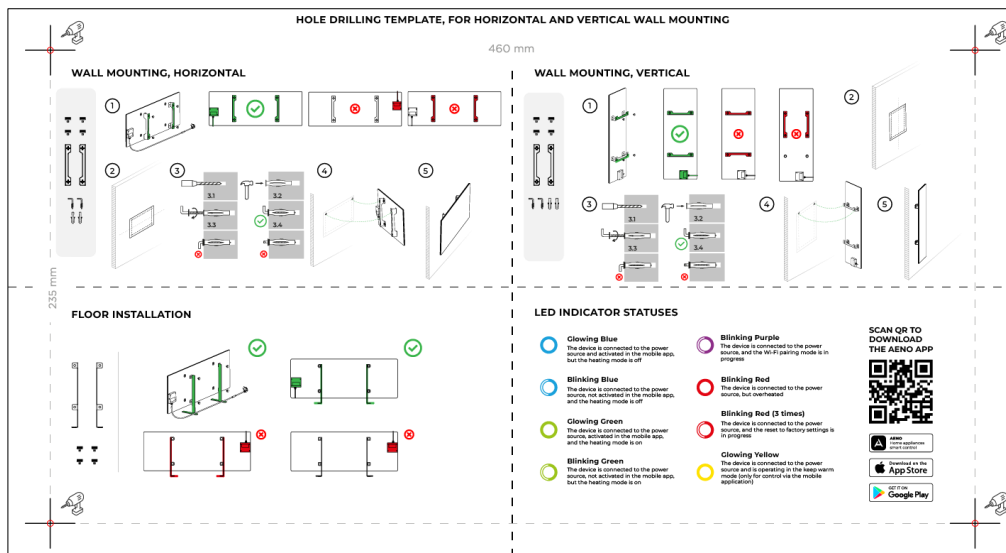

5 – Template for drilling holes in the wall

Figure 5 – Package contents

* The images of accessories are for illustrative purposes only.

1.9 Packaging and Labeling

The AENO™ heater is supplied in an individual carton package of 107×43×9,1 cm (L×W×H) containing the full name and marking of the device, the list of accessories provided and basic technical specifications thereof, as well as the date of manufacture and information about the Manufacturer of devices.

Weight of the carton:

- Net weight: 8.7 kg;
- Gross weight: 10.9 kg.

1.9.1 Labeling Rules and the Date of Manufacture

The date of manufacture is indicated on a sticker on the individual packaging and is also encoded in the serial number specified on the box and the device body.

The serial number is formed as follows:

NNNNNNYWWXXXXX,

where

NNNNNN is internal alphanumeric device model identifier (for example, "AGN101"),

Y is the numeric identifier of the year of production, starting from 2020 (e.g., "2" stands for 2022),

WW is a numeric identifier of the production week (for example, "10" is the tenth week of the specified calendar year),

XXXXX is a numeric identifier of the serial number of the manufactured device.

Thus, the date of manufacture is encoded in the three characters of the serial number (seventh through ninth in order).

In this case, the configuration features of the device are encoded in the model designation.

The model name of the device is formed as follows:

A GH 0001 S -IT -A

Identifier for selling the device at the online marketplace (it does not affect any functionality)

Features of the power cord plug:

IT = plug type L
CH = plug type J
UK = plug type G
SA = plug type M

If there is no marking, the device is equipped with a standard plug type E/F

The possibility of remote control:

S = Smart device activated via the AENO app

If there is no marking, the device is operated manually only

Model number of the AENO™ devices:

0001, 0003 – white color of the device
0002, 0004 – black color of the device
0005 – gray color of the device

Device type:

GH = glass heater

Brand name of the device:

A = AENO™ device

1.10 Space Heating Technologies

Since this device is a micathermic heater, it uses both infrared radiation and convection to heat the room. The proportion of infrared heating is 3 times higher than convection. The advantages of using heaters with infrared & convection heating are as follows:

- Warmth is felt almost immediately because the human body absorbs the infrared rays emitted by the device;
- Convection heating occurs only through contact of air with the device heating panel, as well as with objects and walls heated by infrared radiation;

- It is allowed to use the device in a room with high ceilings, as infrared radiation does not cause movement and accumulation of warm air masses under the ceiling;
- There is no rapid loss of all heat in case of a draught or opening the door, because it is not the air that is heated, but objects and walls;
- The microclimate in the room remains comfortable, because the infrared rays do not heat up and therefore do not dry out the air, as well as do not burn oxygen and do not lead to evaporation of moisture;
- Indoor air movement is kept to a minimum due to a small proportion of convection, which makes it possible to use the heater for extended periods of time in children's rooms.

Nevertheless, in order to achieve the best and fastest heating of the room, the following recommendations should be followed:

- The heater shall be installed in areas with no obstacles to infrared rays, so that the room is heated evenly;
- When using the SMART mode in the mobile app, the desired room temperature shall be set correctly (the heating will automatically turn off when the desired room temperature is reached, so if you still feel uncomfortable in the room after the heater is turned off, please increase the desired temperature).

2 Installation and Operation

Before installation, the User shall select one of the following possible locations and for the device:

- On a flat and stable horizontal surface for installation on legs;
- on a flat non-tilted vertical surface for mounting on brackets.

The User shall also make sure that the selected location meets the following requirements:

- Availability of a power source at the place where the heater is installed;
- Acceptable location of the electrical outlet and the power cable (see Limitations and Warnings);
- Ambient temperature is above 0 °C.

WARNING!

It is strongly recommended that the Eco Smart Heater is installed out of the reach of children and pets, as contact with the device in operation may result in burns. Do not use the Eco Smart Heater on carpets or near curtains or upholstered furniture.

NOTE

It is not recommended to install the device in areas with a high level of noise and a high-frequency interference. Reinforced concrete floors may reduce the distance of wireless signal transmission.

See below possible installation locations for the Eco Smart Heater.

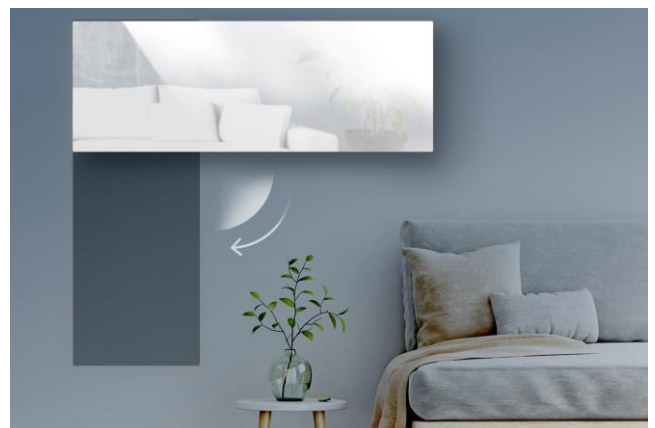



Figure 6 – Examples of heater installation*

* The images are for illustrative purposes only

WARNING!

Vertical orientation of the heater is only possible when mounted on the wall. In this case, you should also consider the length of the power cable and the distance to the electrical outlet, as well as the position of the control unit where the power button is located (inconvenient orientation of the power button may interfere with manual control of the heater).

2.1 First Installation and Setup

To ensure proper installation and proper operation of the heater, the following steps must be followed:

1. Unpack the device, install it in the desired location and connect it to the source of power supply with the power cable.
2. If necessary, activate the device in the mobile app.

IMPORTANT!

After the first activation in the mobile app, the process of updating the heater firmware can be started (the user will receive a corresponding notification). **Do not unplug the device from the mains until the update process is completed!** Also, do not disconnect the device from the mains for **5 minutes** after resetting to factory settings.

2.1.1 Unpacking and Preparing for Installation/Mounting

1. Unpack the heater and accessories carefully.
2. Place the device on a clean horizontal surface with the heating panel facing down.

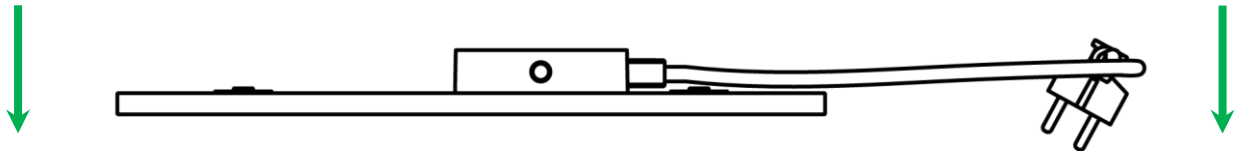

NOTE

It is recommended to place the device on a clean cloth surface.

3. Wipe both sides of the heating panel with a damp cloth soaked in a little water, then with a dry cloth that does not leave streaks. Make sure that there are no traces of dust and dirt on the device.
4. Prepare the installation area and install the heater according to the most suitable option (See below).

2.1.2 Preparing the Installation area

For floor installation:

1. Only horizontal orientation is allowed when the heater is mounted on legs (See Figure 1).
2. All types of fabrics, decorations and other flammable objects including rugs and carpets must be kept at least 1 meter away from heater installation area.

For wall mounting:

WARNING!

Hooks and dowels supplied with the heater are designed to mount it on a reinforced concrete wall only. When installing on a different type of wall you should choose the appropriate fasteners.

1. The heater can be mounted horizontally or vertically on the wall (on 2 or 4 hooks).
2. All types of fabrics, decorations and other flammable objects including rugs and carpets must be kept at least 1 meter away from heater installation area.
3. To drill holes in the wall, please use the special template supplied with the heater.

2.1.3 Floor Installation (Option 1)

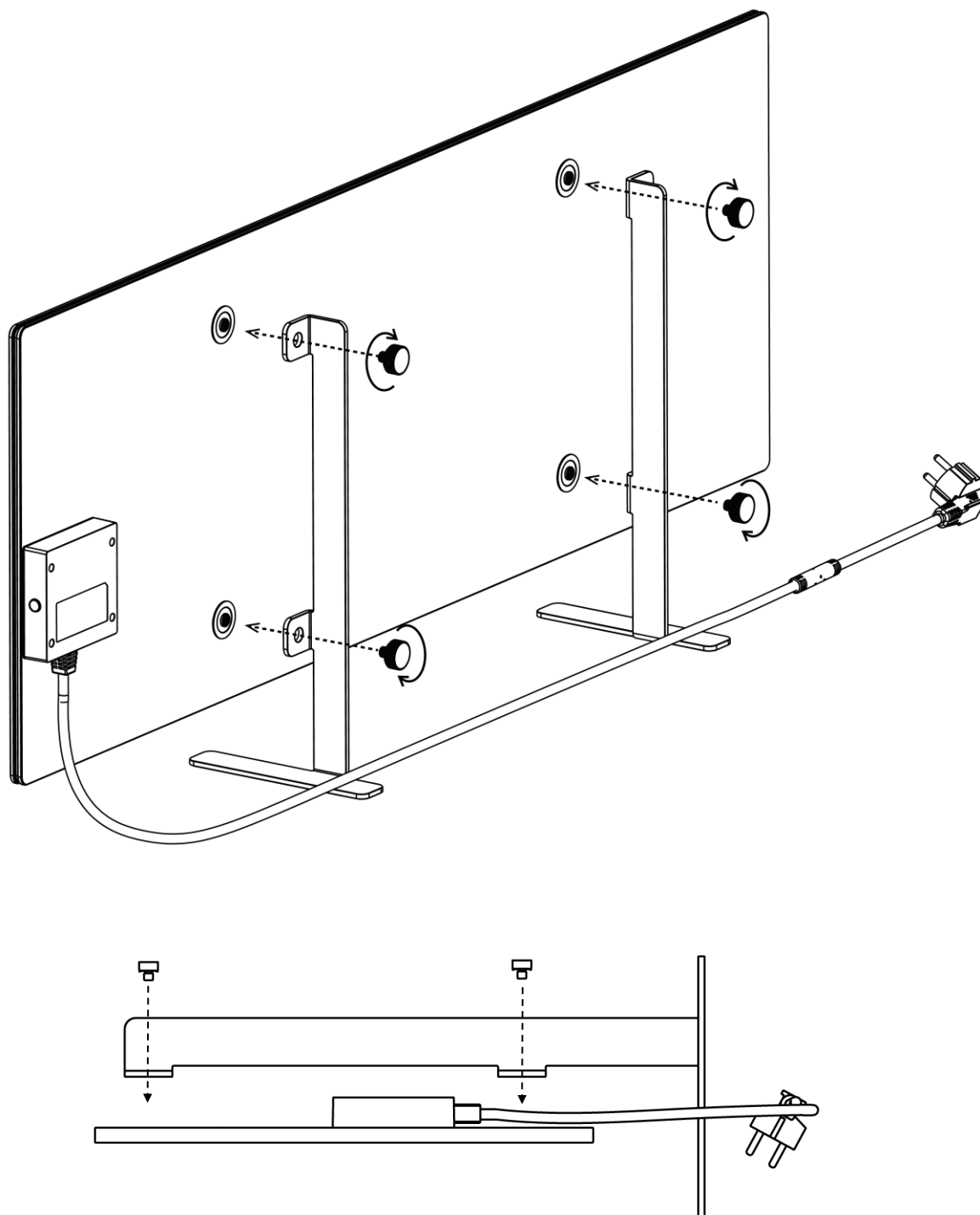
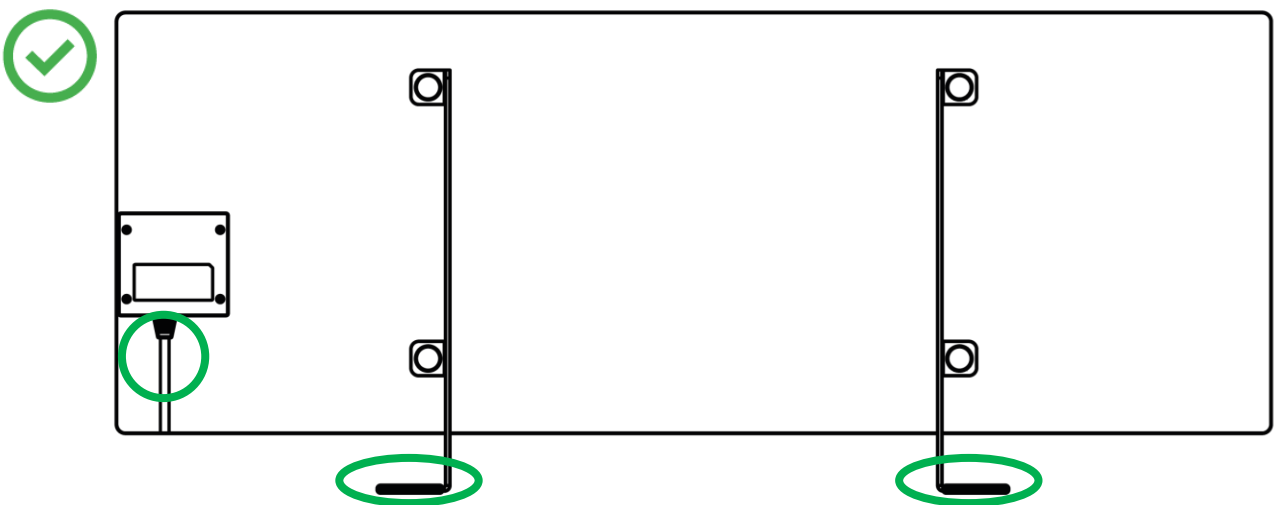

Figure 7 – Mounting on legs (on the floor)

1. Screw the two metal legs to the heating panel with the mounting bolts (See Figure above).

NOTE

During installation, make sure that the mounting bolts are tightened securely and that **legs are correctly oriented** relative to the device body (i.e. the inlet of the power cable to the control unit shall be from below).



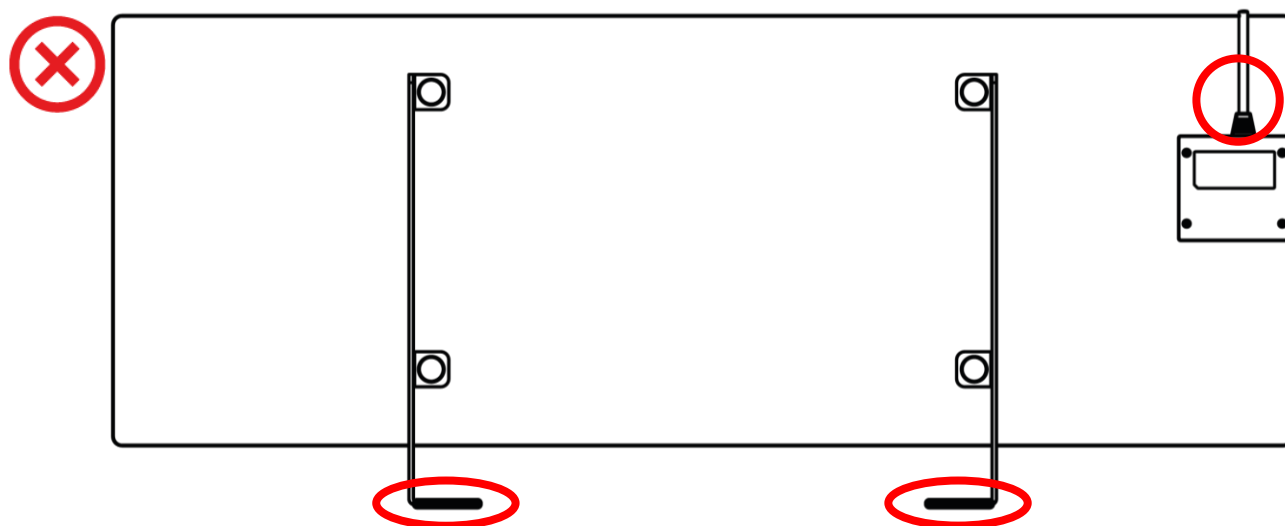
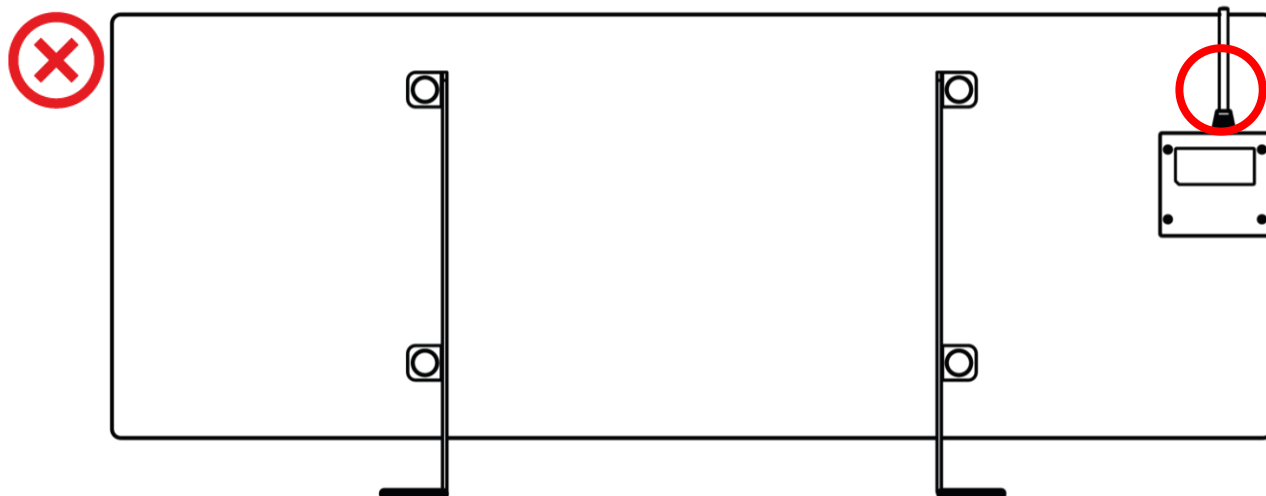

2.1.4 Horizontal Wall Mounting (Option 2)

1. Select the desired orientation of the heater on the wall (horizontally).
2. Screw mounting brackets to the rear surface of the panel correctly.

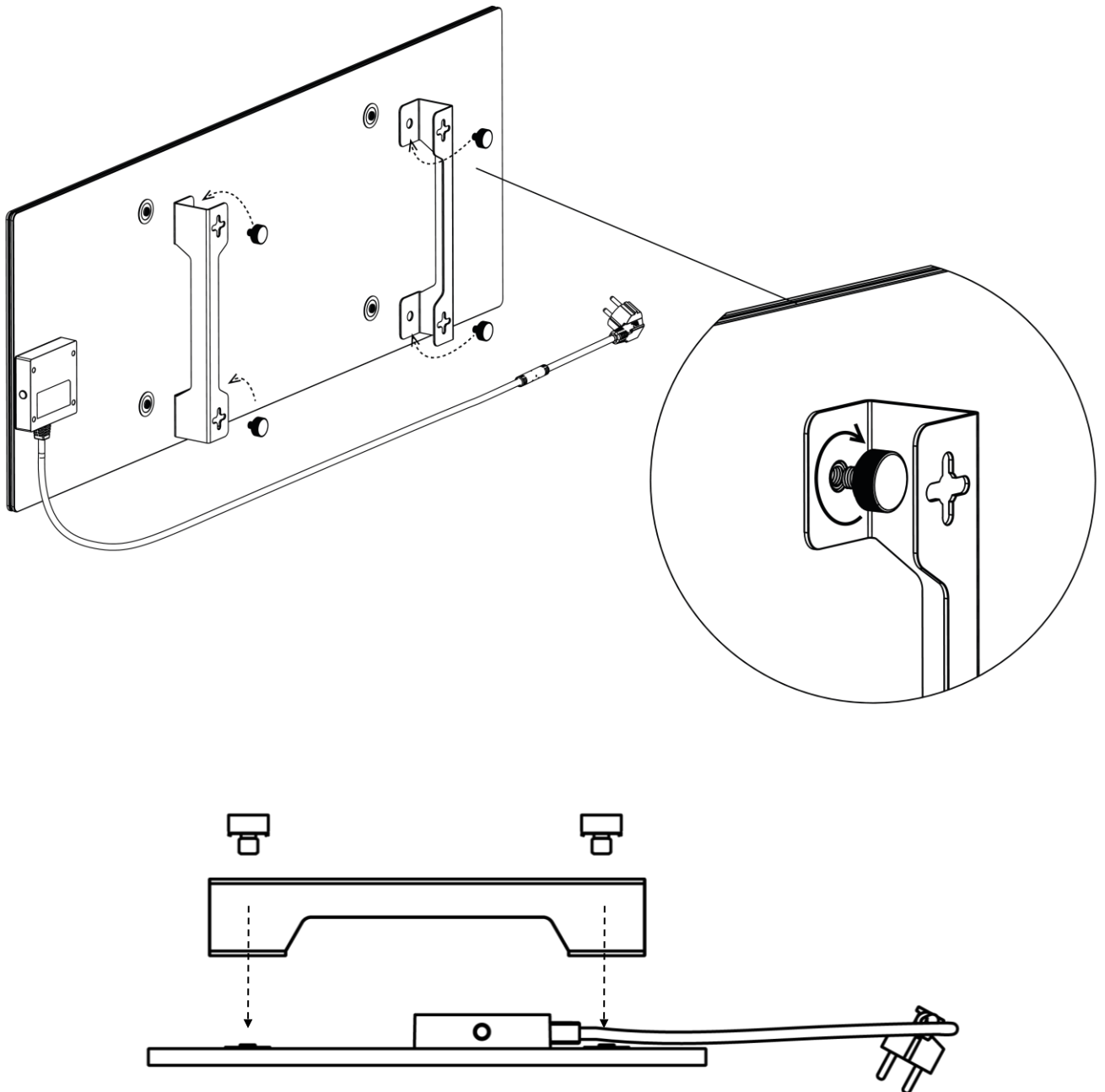

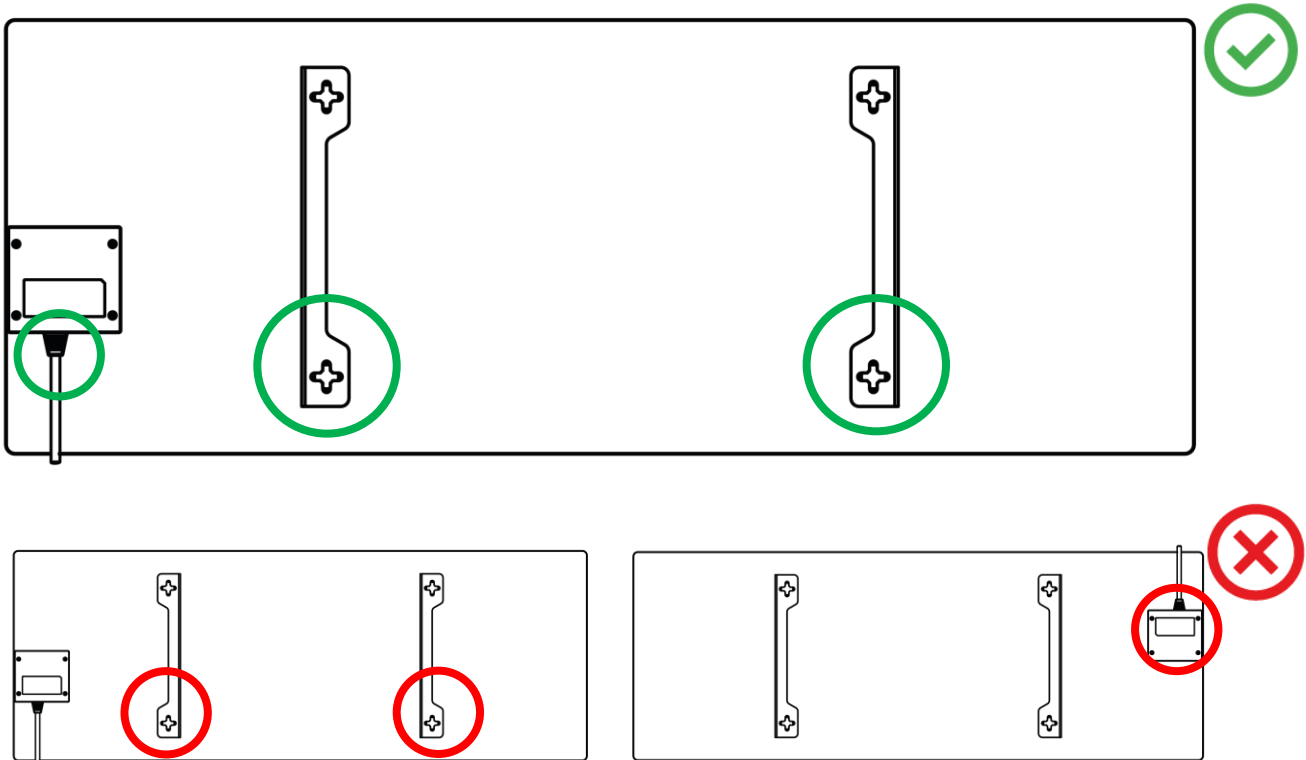
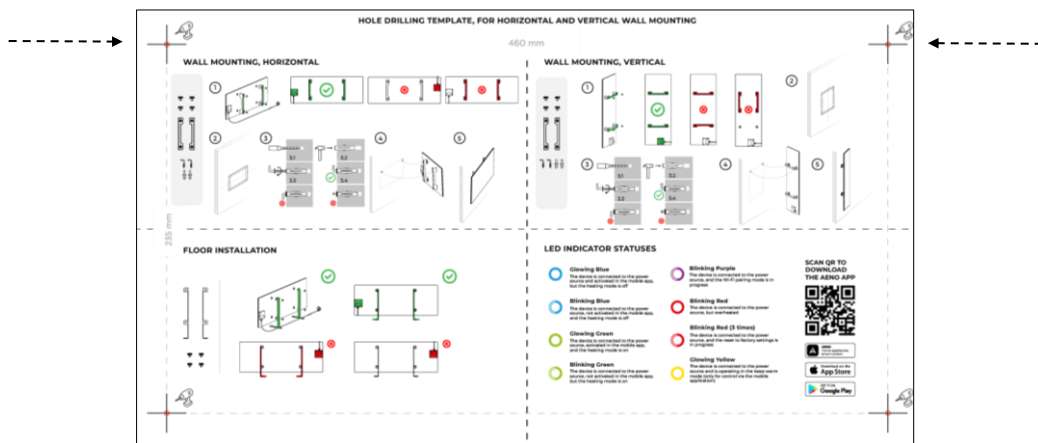
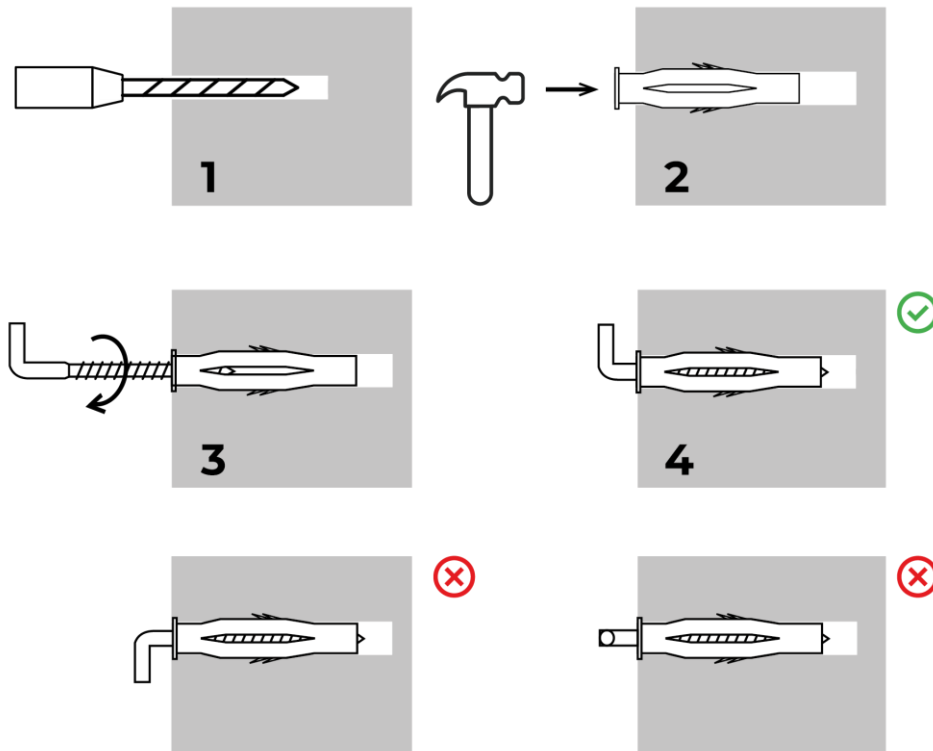

Figure 8 – Installation of the brackets

3. Drill 2 holes in the wall using the special paper template supplied with the device, and then screw in the hooks.



Horizontal orientation of the template



The process of screwing in the hooks

Figure 9 – Preparing of the wall (horizontal mounting)

4. Carefully hang the heater on both hooks at a time.

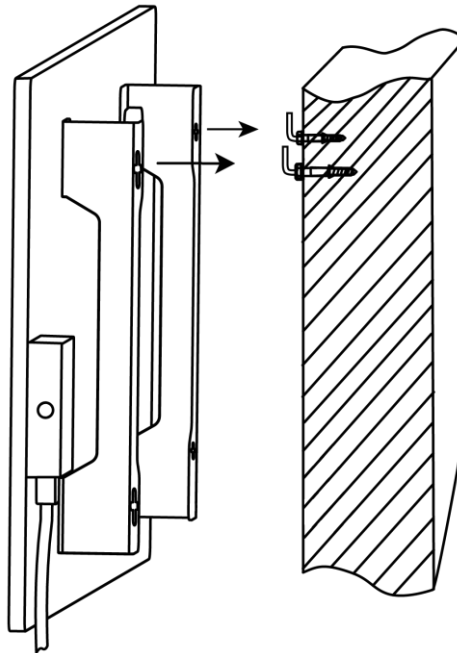

5. Check that the device is securely fixed.

NOTE

During mounting, make sure that the hooks are securely tightened and oriented strictly vertically.

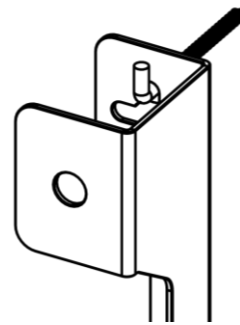
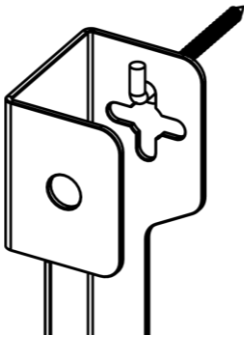

2.1.5 Vertical Wall Mounting (Option 3)

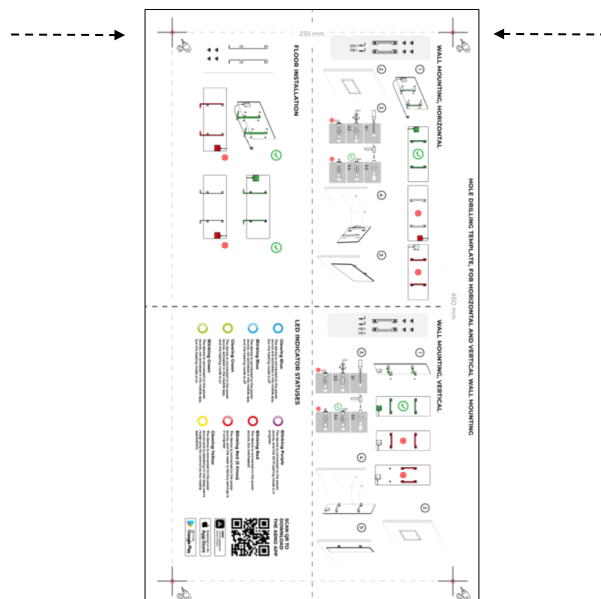

Vertical orientation of the template

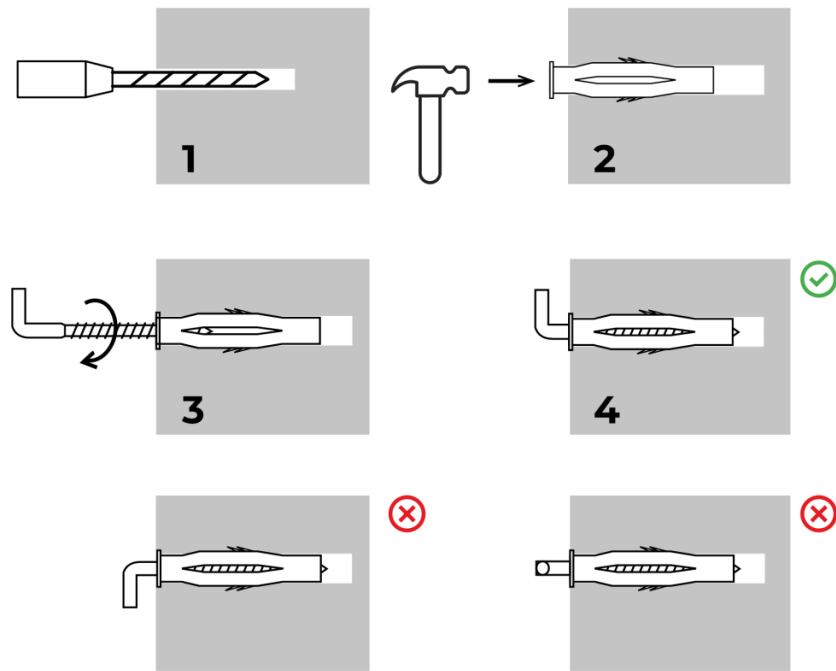

The process of screwing in the hooks

Figure 10 – Preparing the wall (vertical mounting)

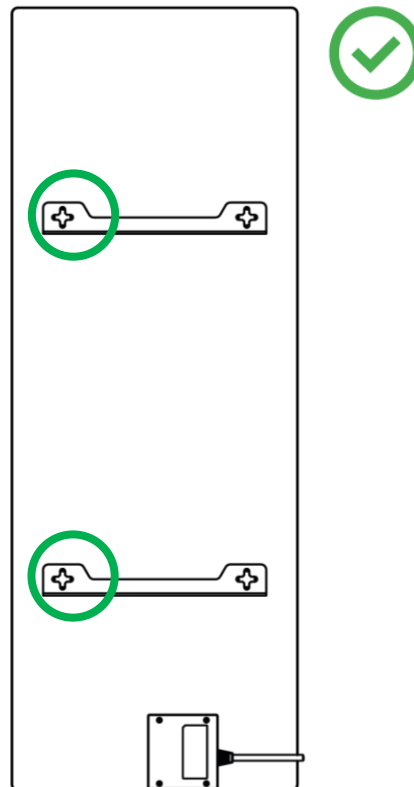

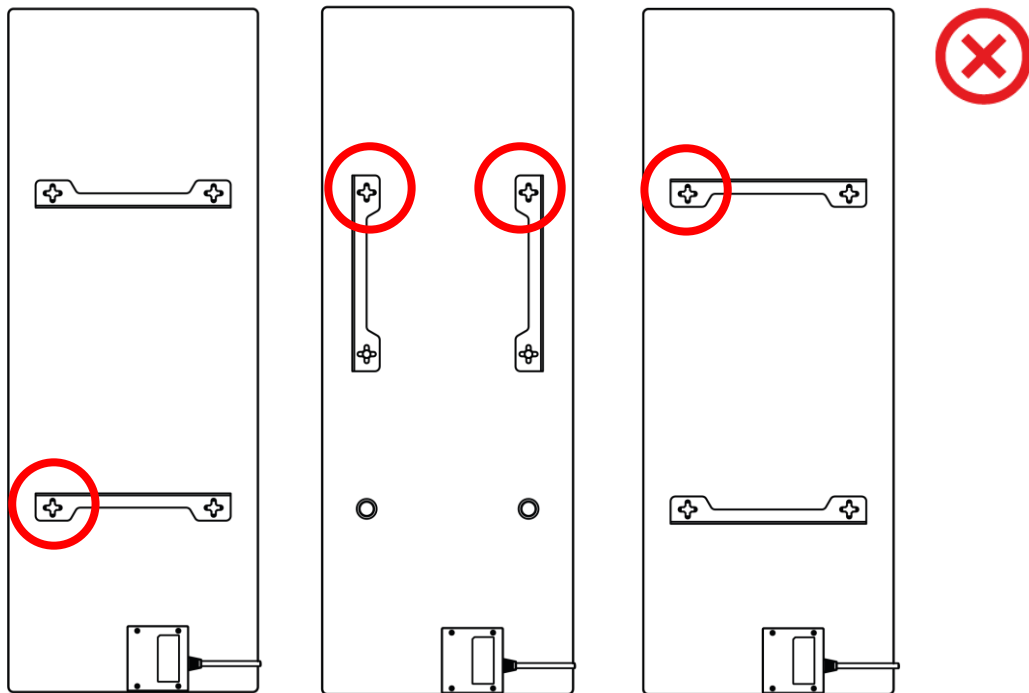

Figure 11 – Vertical installation (wall mounting)

NOTE

The option of mounting the heater with the control unit being on top is acceptable, if the device is installed at a low height and when the location of the electrical outlet does not prevent the heater from being quickly de-energized, as well as if the power cable does not contact the heating panel.

NOTE

During mounting, make sure that the hooks are securely tightened and oriented strictly vertically.

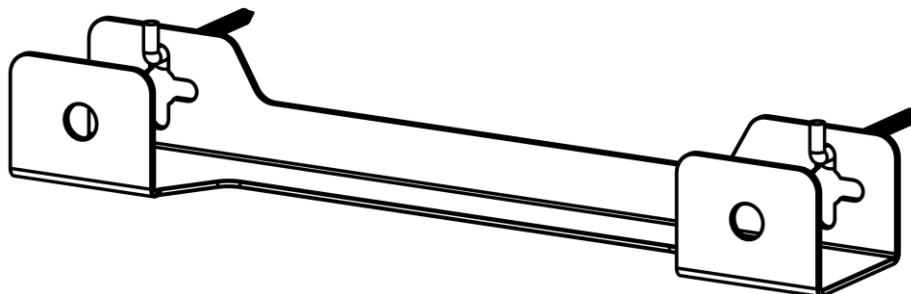

2.1.6 Wall Mounting with 4 Hooks (Additional Fixation)

When mounting on 4 hooks, you need to drill 4 holes in the wall with a template.

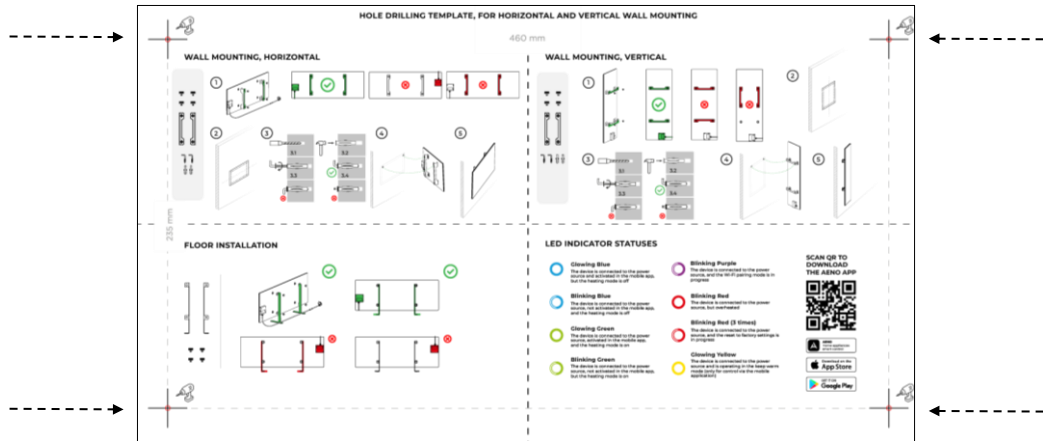

Then follow the instructions for assembling the heater as outlined in par. 2.1.4 or par. 2.1.5 above.

Hang the device on 4 hooks at a time.

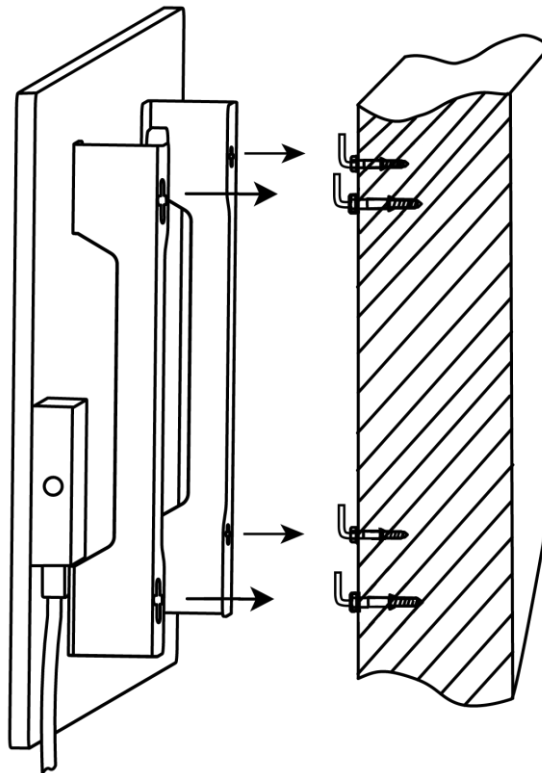

2.1.7 Hardwiring Option

If you decide to mount the heater into the wall in such a way as to hide its power cable or to embed the device in the wall, then you should understand and agree to the following:

- The manufacturer's warranty for the device shall become void;
- The manufacturer shall not be liable for possible changes in functionality or poor operation of the device;
- Any installation operations must only be carried out by qualified installers only who have sufficient knowledge and skills to carry out correct and safe hardwiring of the heater;
- When cutting the power cable, it is not allowed to cut off the temperature sensor;

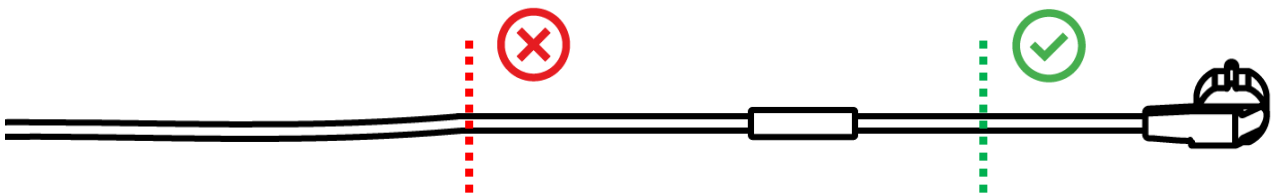

- The device must be installed in such a way as to provide its adequate ventilation and location of the temperature sensor unhidden, i.e. exposed to the room air.

2.1.8 Ceiling Mounting

If you decide to mount the heater on the ceiling, then you should understand and agree to the following:

- Any installation operations must only be carried out by qualified installers only who have sufficient knowledge and skills to carry out correct and safe mounting of the heater on the ceiling;
- The manufacturer shall not be liable for possible installation errors, including but not limited to the use of unsuitable fasteners, as well as for any loss or damage resulting from improper installation work;
- The power cable must not come into contact with the heating surface;
- The device must be installed in such a way as to provide its adequate ventilation and location of the temperature sensor unhidden, i.e. exposed to the room air.

The process of the ceiling mounting shall include the following steps:

1. Powering on the heater (See par. 2.2 below).
2. Activation of the heater in the mobile app (See par. 2.4 below).
3. Enabling the ceiling installation mode in the heater settings (See par. 2.4.10 below).

ATTENTION!

The “Ceiling Mount” setting must always be enabled in the user account (heater control panel) to ensure proper operation of the device on the ceiling.

4. Disconnection of the heater from the mains.
5. Mounting the heater on the ceiling (this step should only be performed by a qualified installer).
6. Powering on the heater again.

NOTE

If the heater is reset to factory settings for any reason, the “Ceiling Mount” setting must be enabled again, or otherwise proper operation of the device cannot be guaranteed.

2.2 Initial Power On

To turn the heater on, you should plug it into an electrical outlet using the power cable and press the power button (See Table 1).

NOTE

By default, the heater will be in a pairing mode for 3 minutes after the first power on. After that, the device will be switched to the standby mode (heating off mode).

Next, you should select one of the ways to control the device:

1. Manual control.
2. Remote control via the mobile app.
3. Remote control via voice assistants.

2.3 Manual Control

2.3.1 Instructions for AGH0001S-AGH0002S Models

The heater may be manually controlled with a single power button located on the control unit of the device.



1. Press and hold the power button for no more than 3 seconds to turn it on for heating.
2. To stop heating, press and hold the power button again for no more than 3 seconds, and the device will be switched to the standby mode.

NOTE

See Table 1 above for more information on the functions of the power button. Please unplug the power cable from the electrical outlet in order to de-energize the heater completely.

2.3.2 Instructions for AGH0003S-AGH0005S Models

The heater may be manually controlled with four buttons located on the control unit of the device.



1. Press and hold the power button for no more than 3 seconds to turn it on for heating.
2. To stop heating, press and hold the power button again for no more than 3 seconds, and the device will be switched to the standby mode.
3. To set the desired room temperature, activate the SMART mode by pressing the corresponding button, and then use the "+" and/or "-" button to set the desired value that will be displayed on the LED display.

NOTE

See Table 1 and Table 3 above for more information on the button functions. Please unplug the power cable from the electrical outlet in order to de-energize the heater completely.

2.4 Remote Control via the AENO App

2.4.1 App Installation

- Connect your smartphone to the Internet (2.4 GHz) and download the free AENO mobile app from Google Play or the App Store.
- Register a new account or log in to an existing account.

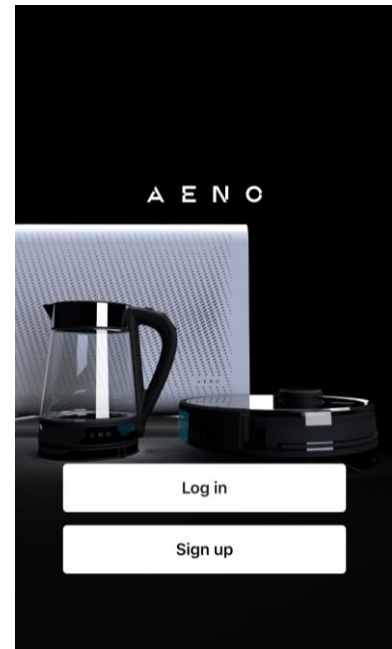

2.4.2 Registering a New Account

- Launch the AENO app and tap the “Sign Up” button.
- Accept the terms of the user agreement and the Privacy Policy.
- Fill out the following information:
 - Select your country of residence;
 - Enter your email address.
- Tap “Get verification code”.
- An email with the registration verification code will be sent to the specified email address. Please enter this code in a special screen of the mobile app.

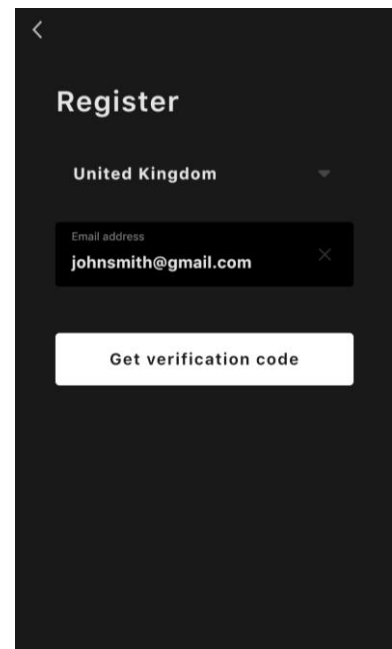
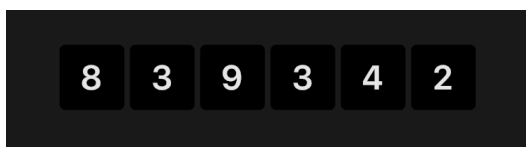

If you don't receive the verification code to your email, it is recommended that you do the following:

- Make sure you entered the correct email address.
- Check your Spam folder if the email is not in your Inbox.
- Try registering an account with a different email address if your firewall has blocked the email.

If none of the above tips are helpful, please contact our support team via the contact form on **aeno.com**. In the request, please provide your email address and the timestamp of your registration.

- After the verification code is successfully entered, you should set a password (6 to 20 characters including at least one letter and one number) and tap "Done". Confirm consent to access the data. If you refuse, some of the data associated with the use of the product will be unavailable for you.
- Confirm your consent to receive notifications and promotional applications. You will not receive notifications from the app, if you opt out.
- Tap the button to switch to the app.

2.4.3 Logging into an Existing Account

- Select your country of residence.
- Enter your email address.
- Enter your password and tap the "Log in" button.

If necessary, you may recover your password by tapping the "Forgot your password?" text. An email with instructions on changing your password will be sent to the email address linked to your user account.

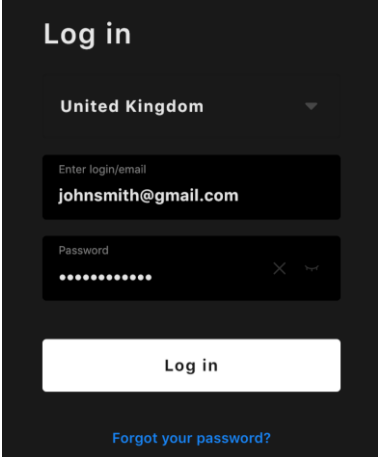

2.4.4 Eco Smart Heater Activation Process

There are several options for activating the heater in the AENO mobile app:

- Initial activation with automatic detection;
- Further activation in the Auto search mode;
- Further activation in the Manual mode.

Initial activation with automatic detection

NOTE

This method can be used to activate the device in the app upon its connection to the mains outlet for the first time.

1. After logging into your account, tap the “+” icon in the “Home” tab.

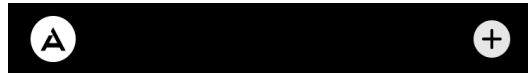

2. Wait till the image of the heater appears in the pop-up window and tap “Add”.

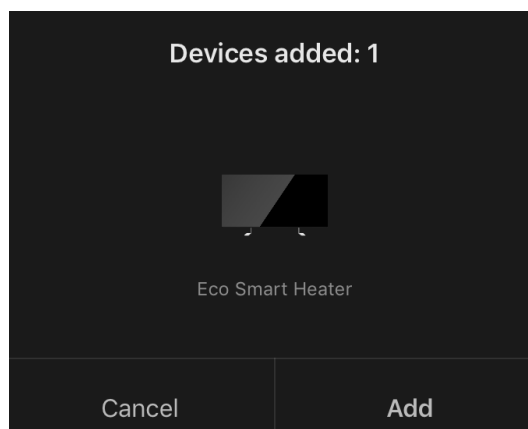

3. Enter the Wi-Fi network password to which the device will be connected (you can choose another network if it is of 2.4 GHz).

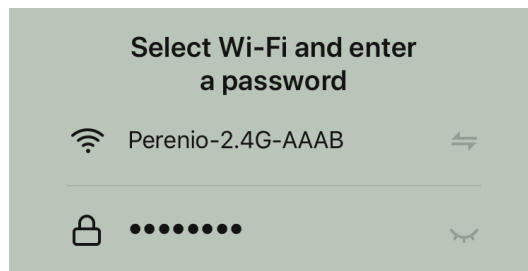

4. Wait for the device to be connected to the app and tap “Next”.

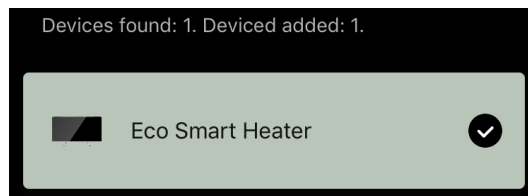

5. Specify the desired name for the heater and select the room of installation from the list. After that, tap “Done”.

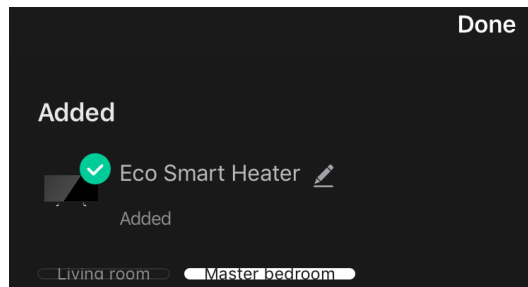

Further activation in the Auto search mode

NOTE

This method can be used in all cases where the heater is in the pairing mode.

1. After logging into your account, tap the “+” icon in the “Home” tab.



2. Select the Auto Search tab at the top of the screen.



3. Provide the AENO app with all requested accesses.
4. Wait for the heater to be detected and tap the “Next” button.

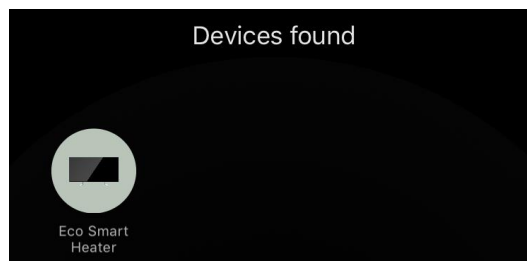

5. Enter the Wi-Fi network password to which the device will be connected (you can choose another network if it is of 2.4 GHz).

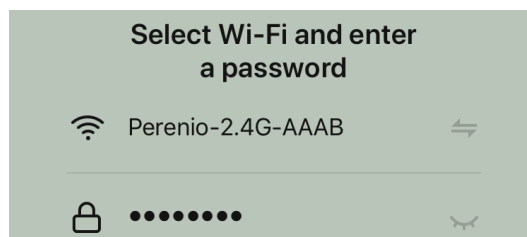

6. Wait for the device to be connected to the app and tap “Next”.

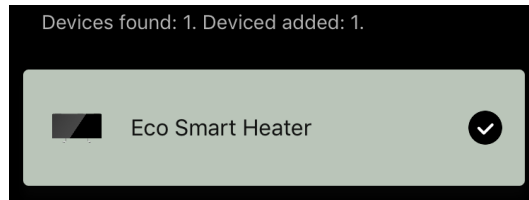

7. Specify the desired name for the heater and select the room of installation from the list. After that, tap "Done".

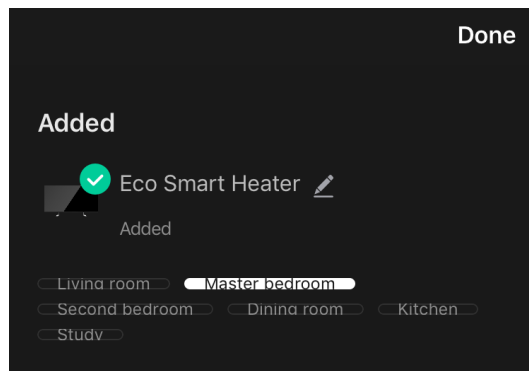

Further activation in the Manual mode

NOTE

This method can be used in all cases where the heater is in the pairing mode and when it was not automatically detected via other activation methods.

1. After logging into your account, tap the "+" icon in the "Home" tab.



2. Select the "Manually" tab at the top of the screen and then the "Heater" category.

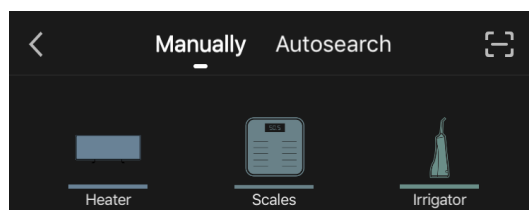

3. Turn on the heater by pressing its power button once. The LED indicator light will turn green.
4. Then press and hold the power button until the LED starts blinking purple.
5. On the screen with the connection instructions, confirm that the indicator is blinking purple and tap "Next".

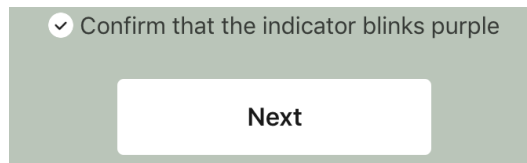

6. Wait for the heater to be detected and tap on the "+" icon next to its name.

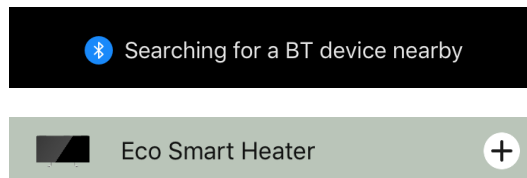

7. Enter the Wi-Fi network password to which the device will be connected (you can choose another network if it is of 2.4 GHz).

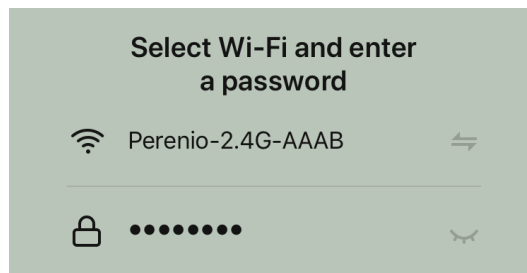

8. Wait for the device to be connected to the app and tap "Next".

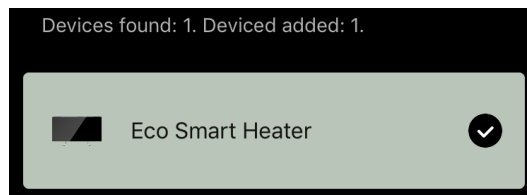

9. Specify the desired name for the heater and select the room of installation from the list. After that, tap "Done".

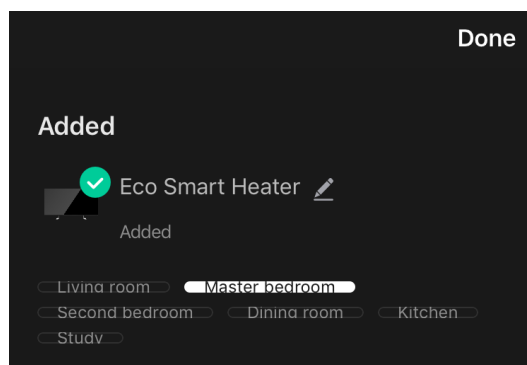

2.4.5 Control Panel of the Eco Heater

The heater's control panel is displayed if you tap on its image in the list of connected devices in the "Home" tab.

In the control panel the user can:

- View the current room temperature;
- Set the desired room temperature;
- Turn the device on and off and select its operating mode;
- Set timers and view power consumption statistics;
- Change the settings.

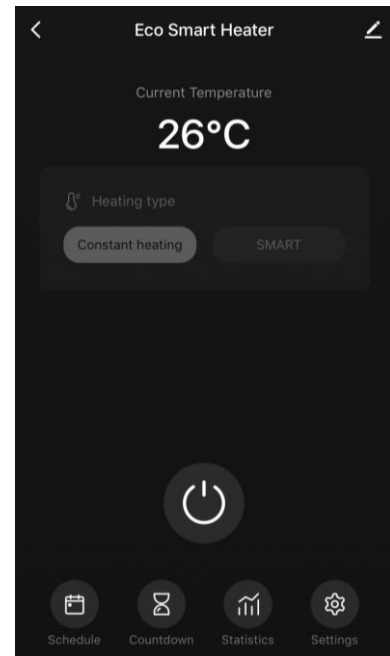

2.4.6 Operating Mode Selection

There are two modes of operation available in the heater's control panel:

- Constant heating, where the heater is switched on and off manually by the user, and the temperature of the room heating cannot be adjusted;
- SMART, where the room temperature is controlled by a built-in sensor. The set value is maintained without the user, i.e. the heating element is switched on or off as needed.

NOTE

The default setting after the heater is activated in the app for the first time is manual operation.

You can select the operating mode only after turning on the heater. You can turn it on manually or from the control panel by pressing the power button .

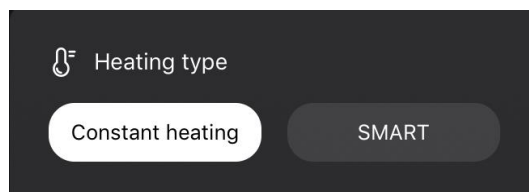

SMART mode settings

The SMART mode allows you to set the desired room heating temperature from 0 to 40 °C.



NOTE

If the set temperature is lower than the current room temperature, the device will be switched to the standby mode, i.e. the heating will be turned off.

The step for changing the desired temperature value is 1°C.

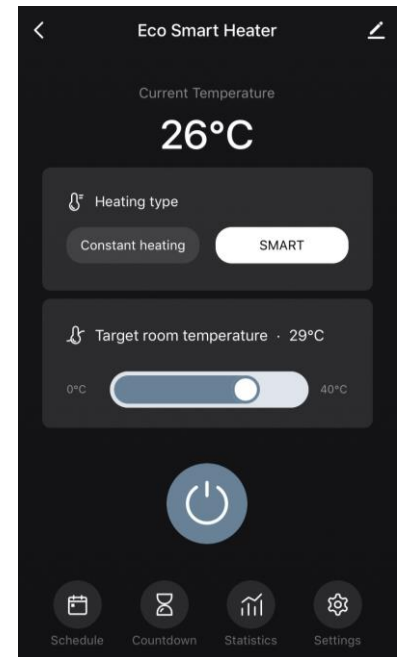

2.4.7 Setting the Heater Schedule

To operate the heater on a schedule, you should tap the “Schedule” tab in the control panel of the device.

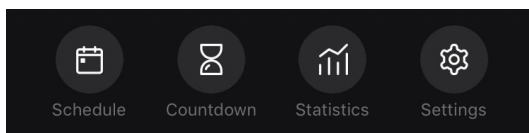

Next, tap on the “Add” button.

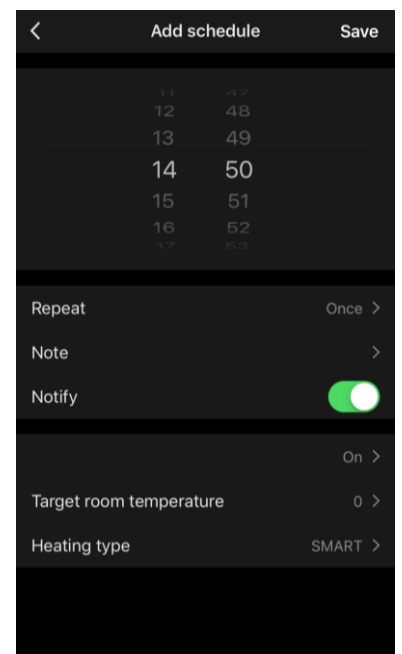
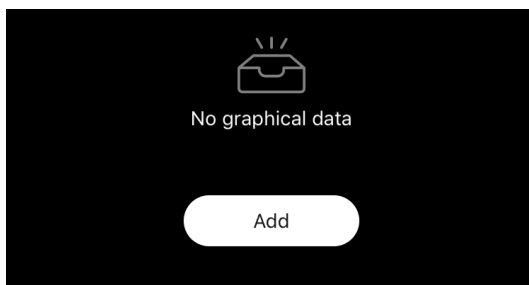

The following settings are available:

- Start time,



- Repetition by day of the week,

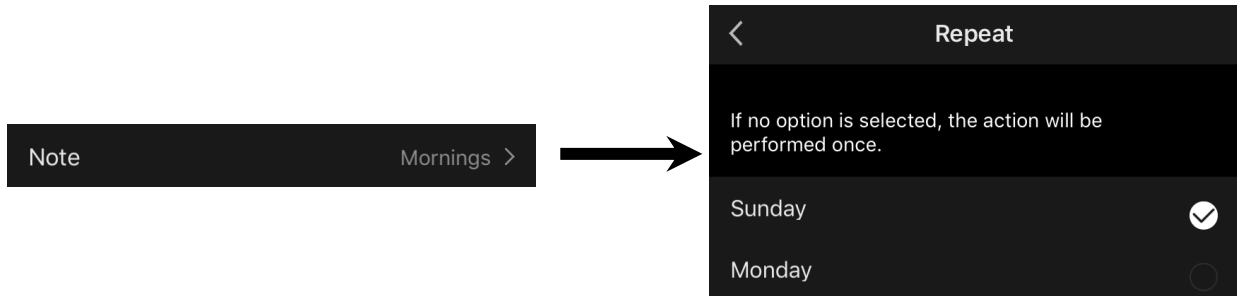

- Entering a user note that will be displayed in the list of schedules and push notifications,

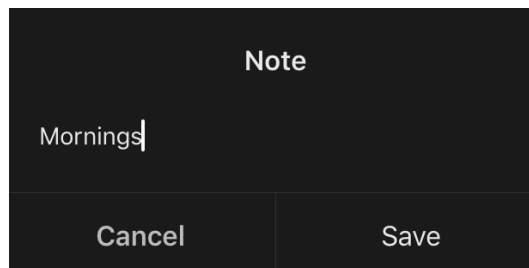

- Option to receive push notifications when this event starts,



- Action to be triggered by time (switching the heater on or off),

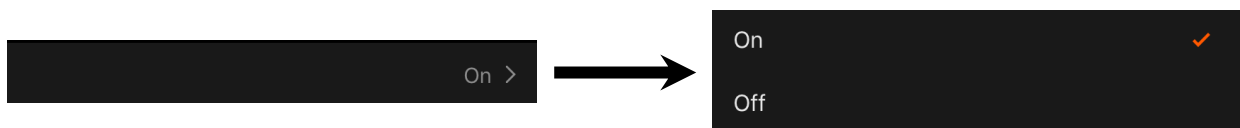

- The desired room temperature for the schedule for turning the heater on,

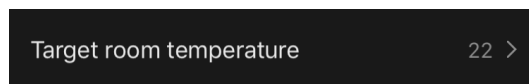

- The type of heating for the schedule for turning the heater on.

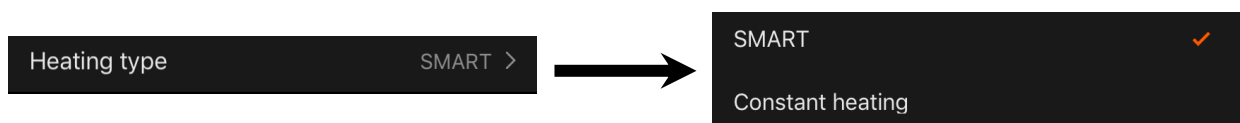

2.4.8 Setting the Countdown Timer

The countdown timer allows the device to be turned off automatically after a specified interval of twenty-four (24) hours.

The time step is 1 hour.

To set the countdown timer, tap the “Timer” tab in the control panel of the heater.

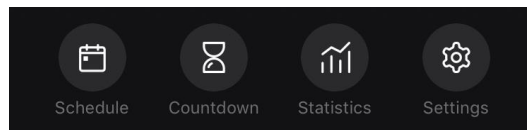

The timer is considered activated when a check mark is placed next to the value of the time interval after which the heater will turn off. Tap “Done” to save the timer settings.

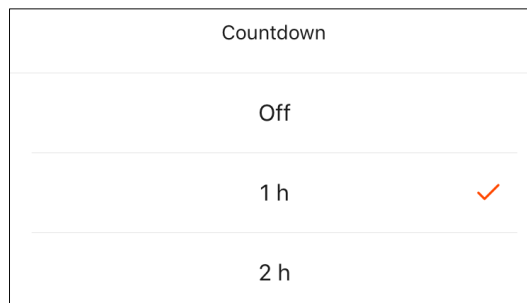

The time when the device is turned off will be displayed in the control panel.



2.4.9 Energy and Power Statistics

In the Statistics section, you can view the following information:

- Current power consumption and consumed energy of the heater;

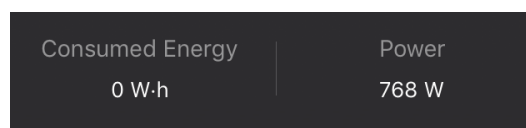

- Energy consumption and power statistics diagrams for the day or the month;

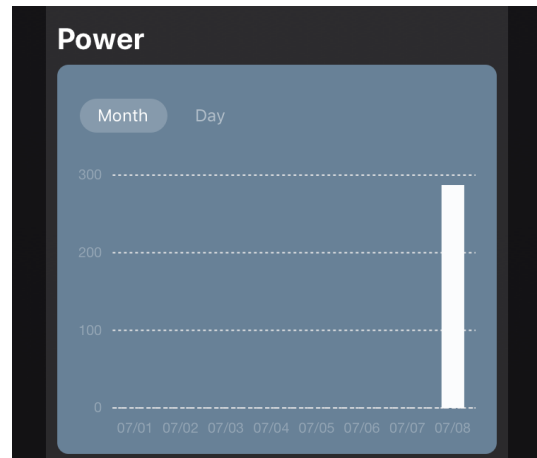
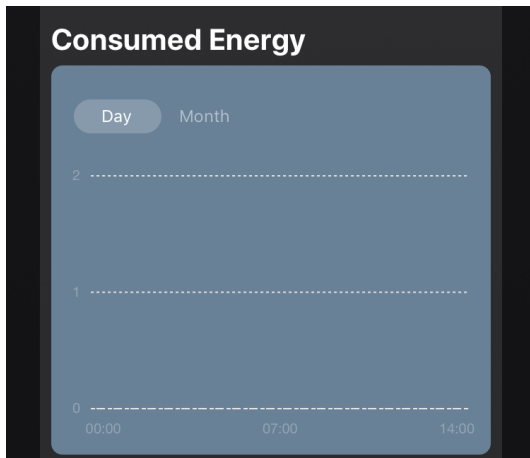

- The list of heater statuses by days with timestamp of the event.



2.4.10 Changing Settings

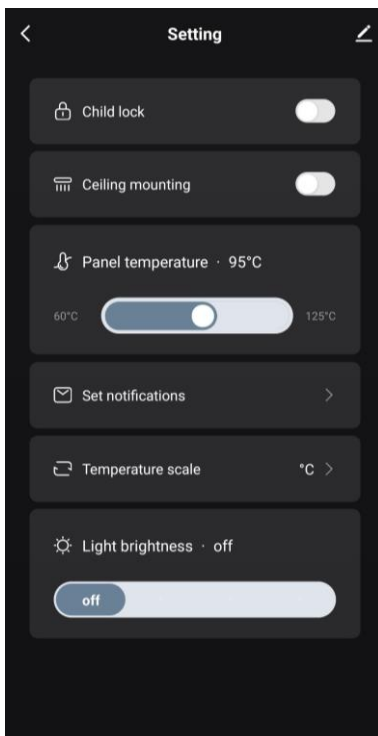

In the “Settings” tab of the heater control panel, the user can perform the following actions:

- Activate the Child Lock mode. When activated, the heater will not respond to pressing a physical button, and all control may be done through the app only;
- Activate the function required to install and operate the heater on the ceiling;
- Set the desired heating temperature of the panel;
- Customize notifications;

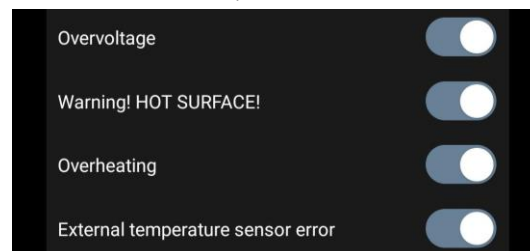

- Choose a temperature scale;
- Adjust the brightness level of buttons or turn it off.

2.4.11 Additional Settings

To open the additional settings screen, tap the  icon in the upper right corner of the device control panel.



In the additional settings panel, you can perform the following:

- Change the screen saver, name and the room of installation of the device (tap  next to the heater name);
- About the device: View reference information about the device operation;
- Scenarios and automations: View scenarios where the device is involved;
- Third-party services: Integrate the account with Alexa and Google Assistant services for voice control of devices;
- Notify when the device goes offline: Enable or disable push notifications;
- Shared access: Provide access to device control to another account, for example, for family members;
- Create group: Unite devices to manage them as a single group;
- Help & Support: Get information about the most common problems and how to solve them;
- Add to home screen: Add a device shortcut to your smartphone's home screen for quick access to the device control panel;
- Checking the network: Launch scanning the Wi-Fi network, its signal strength and network connection status;
- Update device: Check and install the latest updates for the device or activate the automatic update;
- Delete device: Remove the device from the mobile app.

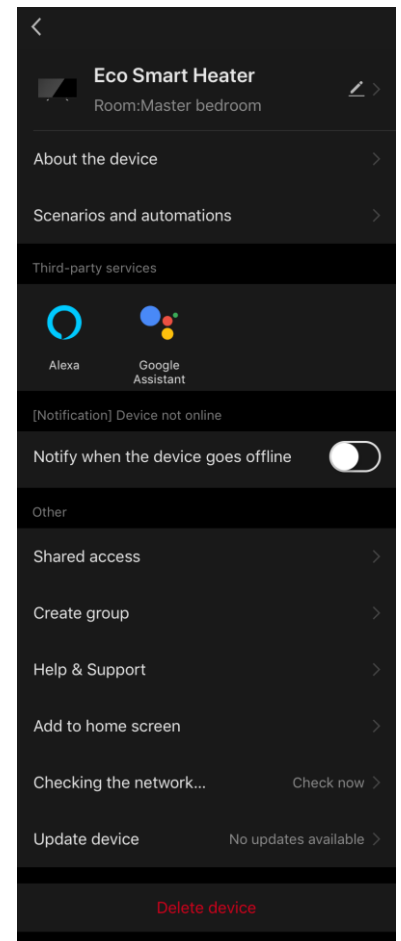

Shared Access

In the AENO app, a device can only be connected to one account. However, the user may share this device with other users.

Through sharing, other users can control the device, change modes and operation settings, but cannot set or modify device data, create scenarios, or remove devices from the application.

To share your device, open to the additional settings menu and tap “Shared access”.

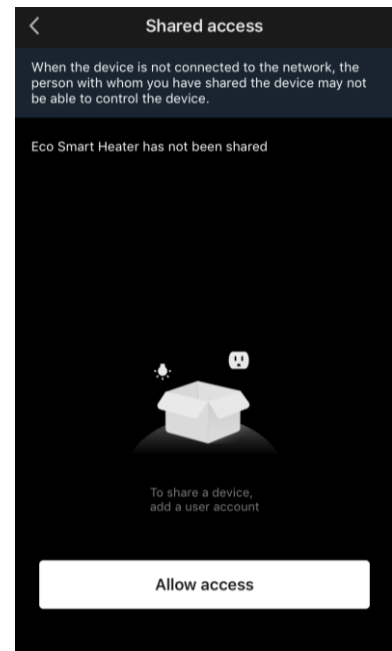

Tap “Allow Access” and tap “Share with the account AENO”.

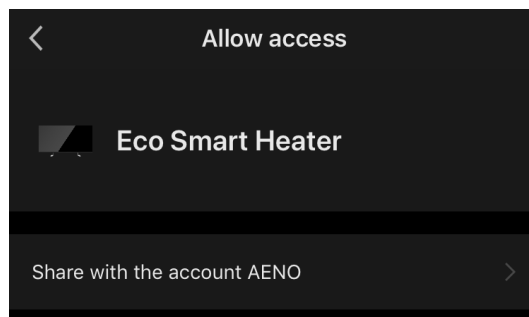

Select the country of residence and the e-mail address of the user you want to share access with. Tap “Done”.

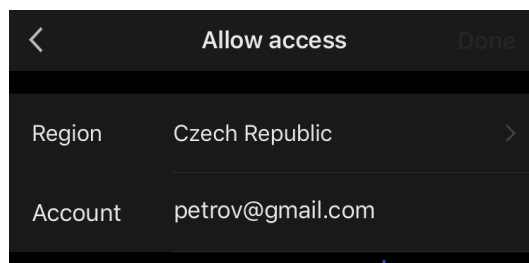

In the “Shared access” section, tap “Allow Access” again, and then tap the icon of the desired user. The corresponding notification will appear that access has been successfully granted.

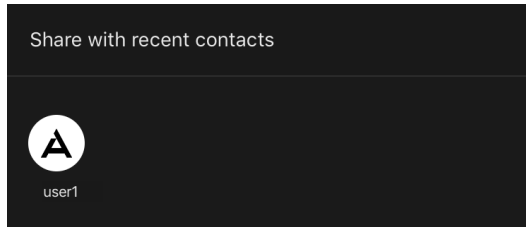

Information about the user will be displayed in the “Shared access” section.

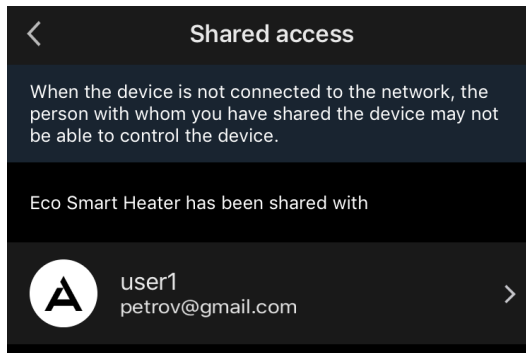

Tap on the line with the added account in this section to set the validity period for the access or to cancel sharing.

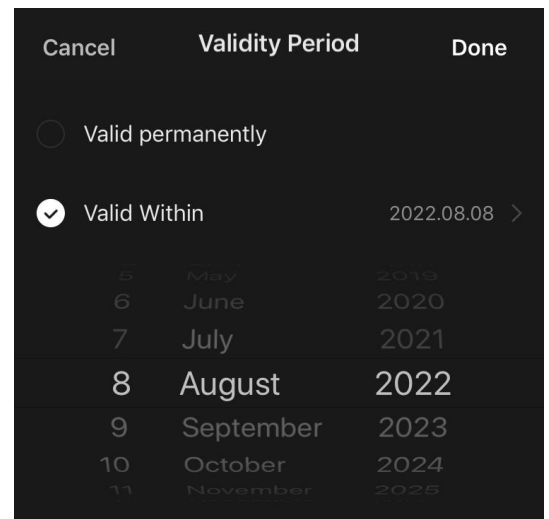
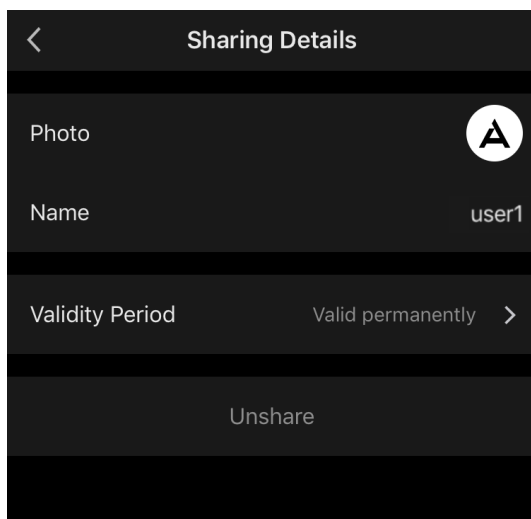

This device will appear in the granted access section of the “Home” tab in this user account.

Create Group

From the AENO app, you can manage individual devices or groups of devices. To group devices, tap “Create group” and select the desired heaters from the list. Then, tap “Save”.

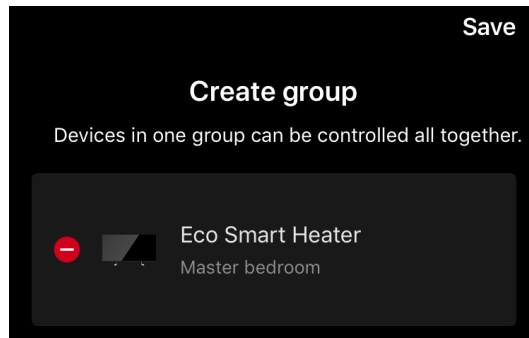

NOTE

Only devices of the same type can be grouped.

Then, set the desired name for the group and tap “Save”. The created group is displayed in the “Home” tab.

NOTE

For more information on the AENO app functionality, see the corresponding complete user manual available for downloading at aeno.com.

2.4.12 Scenarios and Automations

In the “Scenarios” tab, the user can select conditions for automation and/or create and manually run scenario.

Automation is an event that starts automatically and is triggered every time the conditions specified in it are met.

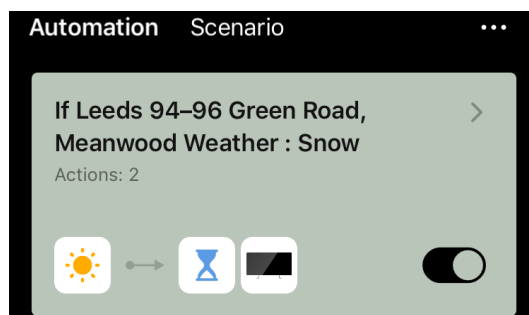

NOTE

In other words, it is an automatic scenario.

Scenario is an event that is triggered manually at the user’s request and is executed once if the conditions specified in it are met.

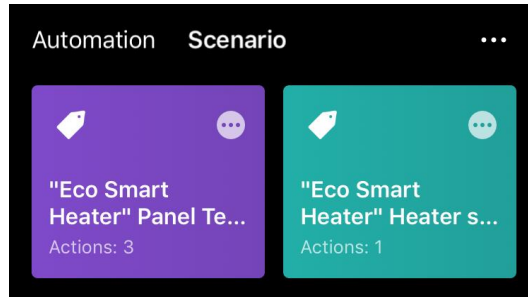

NOTE

In other words, it’s a manual scenario.

Automation (creating an automatic scenario)

- Tap the “Scenarios” tab and then tap “+”.
- Select one of the conditions launch an automatic scenario.

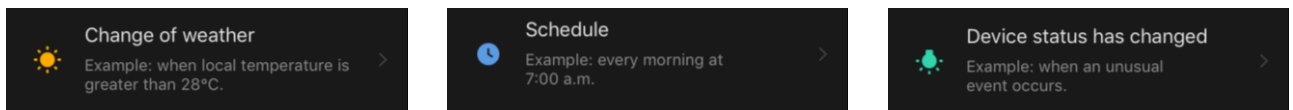

Change of weather: The scenario will run when the weather conditions match the parameter selected by the user. For example, when it gets wet.

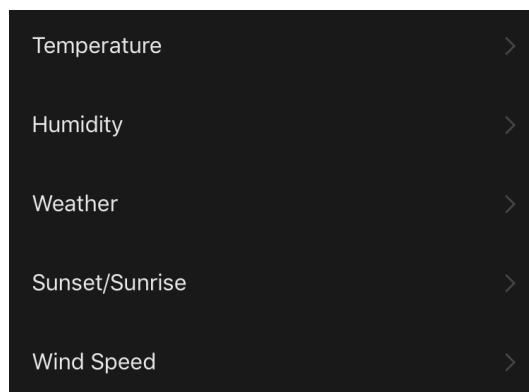

NOTE

In order to start the automation correctly, it is necessary to specify the exact address of the place where you want to read the weather conditions.

Schedule: The scenario will run at a specific time. Here you can also set the days of the week to repeat this scenario.

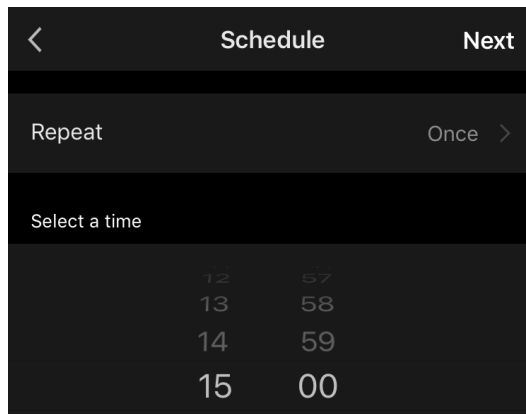

Device status: The scenario will run when the selected event occurs. For example, when the room temperature drops to 19°C or when the heater's power consumption limit set by the user is exceeded.

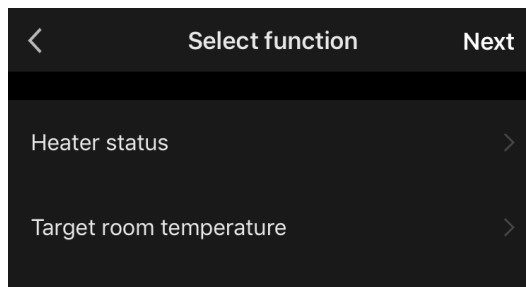

- Tap “Next” at the top of the screen.

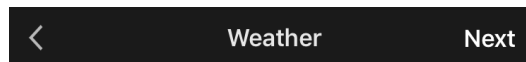

- Select one of the actions that will occur when selected condition appears:

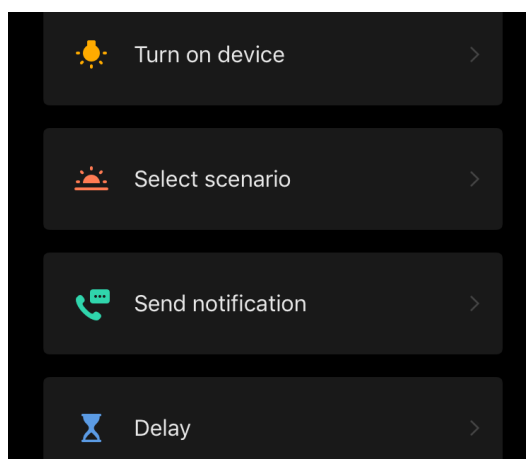

Device status: The selected event will occur. For example, the heating type will be changed or the panel heating temperature will increase to 100 °C.

Select scenario: Previously created scenario or automation will run.

Send notification: The user will receive a notification via the message center.

Delay: The time delay will be set before the next action is triggered. In this case, it is necessary to add one more action after the specified delay.

- Tap “Next” at the top of the screen.
- If necessary, add an additional condition and/or action by tapping “+” in the corresponding block.

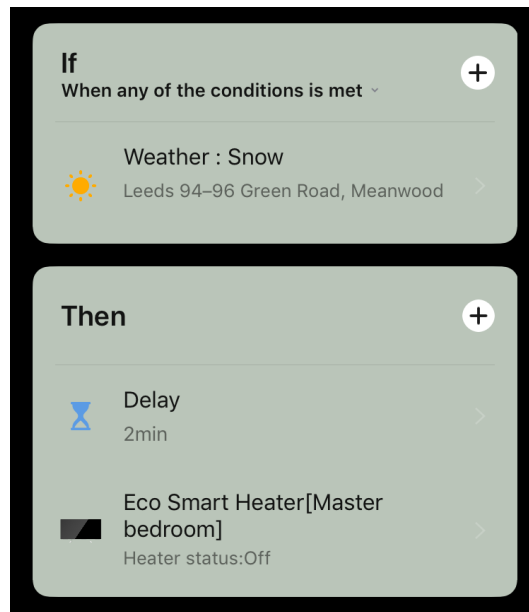

- Tap “Save”.
- Enable the created automation, if necessary.

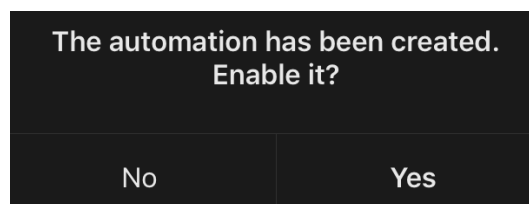

- It can also be activated later in the “Automation” section.

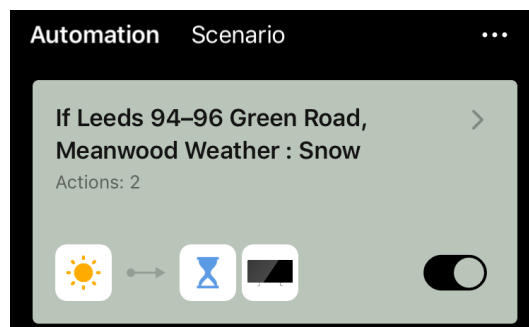

Scenario (creating a manual scenario)

- Tap the “Scenarios” tab and then tap “+”.
- Select the “Execute scenario” condition.

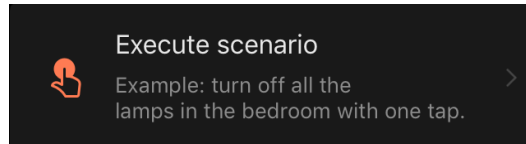

- Select one of the actions that shall be performed after you run the scenario:

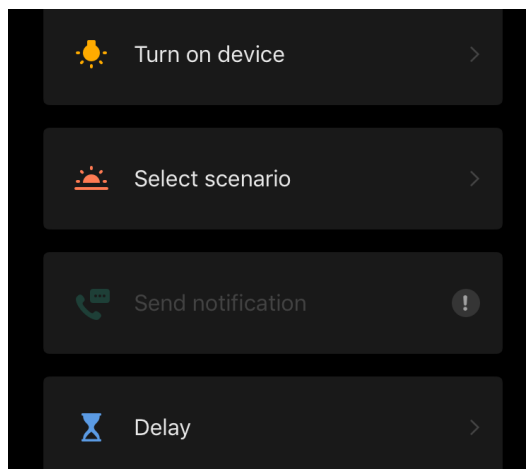

Device status: The selected event will occur. For example, the heating type will be changed or the panel heating temperature will increase to 100 °C.

Select scenario: Previously created scenario or automation will run.

Delay: The time delay will be set before the next action is triggered. In this case, it is necessary to add one more action after the specified delay.

- Tap “Next” at the top of the screen.
- If necessary, add an additional condition and/or action by tapping “+” in the corresponding block.

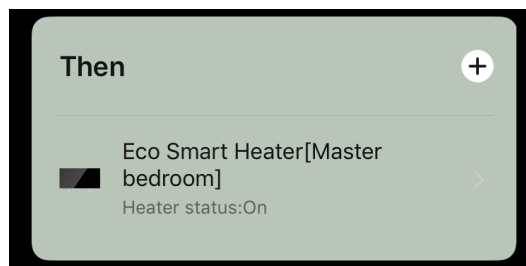

- Tap “Save”.

- The created scenario will be displayed in the “Scenario” section.

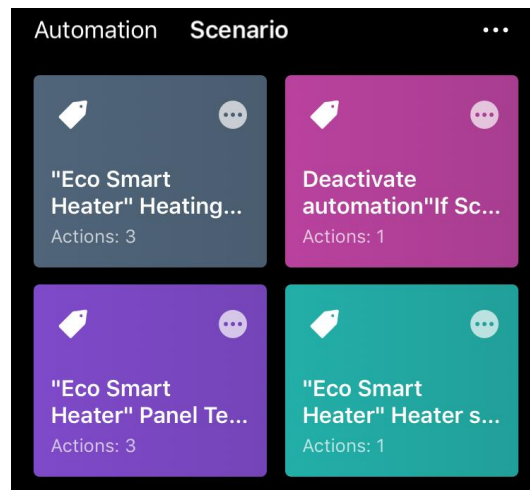

To run the scenario, you should tap its image in the list.

To make changes to the created script, tap “•••”.

2.5 Child Lock Mode

The Child Lock mode means locking the power button of the device via the mobile app.

NOTE

This mode can only be activated remotely after connecting the device via the mobile app.

If the mode is activated, the heater will beep every time its power button is pressed. The button itself will be locked.

There are two following ways to disable the Child Lock mode:

1. Remotely via the AENO app.
2. Manually by pressing the power button 5 times within 4 seconds.

2.6 Adjusting and Turning Off the Buttons LEDs

The brightness level of the LED of the buttons on the device control panel can be adjusted via the mobile application.

The following brightness adjustment options are available:

Level of Brightness	Intensity of Light
Maximum	100%
Middle	50%
Low (default value)	30%
Off	0%

2.7 Remote Control Via Voice Assistants

To control the heater via the Google Assistant or Amazon Alexa app, it must first be activated in the AENO app.

Detailed instructions for managing the heater with voice assistants are available for downloading from the respective manufacturers of these services.

3 Maintenance and Repair

The AENO™ heater does not require special maintenance in the normal course of operation. However, in order to maintain the proper state and stable operation of the device it is recommended to perform the following actions from time to time:

- Follow rules of safe operation of the device;
- Clean the device casing from dirt and dust from time to time (at least once per the heating season);
- Check for updates of the mobile app (If auto update is not enabled);
- Repair mechanical damages to devices (in Service Centers).

The AENO™ heater repairs shall be carried out in Service Centers.

In the case of warranty repairs or replacement, the User shall provide the Seller with the sales receipt and the purchased device.

For details on the replacement and repairs of the AENO™ heater, please contact your local Company representative or the Tech Support Department at aeno.com.

4 Warranty Obligations

The service life of the device is three (3) years. The manufacturer's warranty for this product is three (3) years from the date of retail sale. The manufacturer's warranty on accessories is three (3) years from the date of retail sale.

You may have other rights under the laws of your country that govern the sale of consumer goods. This limited warranty does not affect such rights.

The manufacturer guarantees proper functioning of all materials, components and assembly of AENO™ products provided that the rules of operation set forth in the user manual of the device are followed during the warranty period.

For warranty replacement, the device must be returned to the retailer, along with the receipt verifying the purchase.

The following are not considered defects:

- the smell of new plastic or rubber emitted by the device during the first days of operation;
- change of color shade, gloss of equipment parts during operation;
- noises (not exceeding the sanitary norms) related to the principles of operation of the individual components, namely:
 - fans;
 - water valves;
 - electrical relays;
 - electric motors;
 - belts;
 - compressors;
- noises caused by natural wear and tear (aging) of materials, namely:
 - crackling during heating/cooling;
 - creaks;
 - minor knocking of moving mechanisms;
- the need to replace consumables and wear parts that have become unusable as a result of their natural wear and tear.

4.1 AENO™ Service Centers

For a list of cities where the manufacturer's service is available, visit aeno.com.

4.2 Warranty Service Procedure

If you discover a suspected fault or defect in the device, you should contact an authorized service centre before the warranty period expires and provide the following information:

1. A device with an alleged fault or defect.
2. Original document confirming the purchase.

In the absence of an authorized service centre, the customer should contact the store where the device was purchased.

Warranty service does not cover:

- the adjustments, setting, cleaning and other care of the product as specified in this user manual;
- the replacement of consumables (batteries, filters, light bulbs, dust bags, etc.) as specified in this document.

4.3 Limitation of Liability

Products with manufacturing defects are subject to warranty service during the warranty period. In this case, the warranty period is extended for a period equal to the duration of the repair.

AENO™ products are not eligible for free warranty service if the following damages or defects are found:

- damage caused by force majeure, accidents, negligence, intentional or careless actions (omissions) of the buyer or third parties;
- damage caused by the effects of other objects, including but not limited to exposure to moisture, dampness, extreme temperatures, or environmental conditions (or if they change drastically), corrosion, oxidation, ingress of food or liquid and exposure to chemicals, animals, insects, and their products of vital activity;

- if the device (accessories, components) has been opened (the seals are broken), altered or repaired by anyone other than an authorized service centre, or with unauthorized replacement parts;
- defects or damage caused by improper use, misuse, including use contrary to the operating instructions;
- defects caused by normal wear and tear, including bags, cases, battery packs, or user manuals;
- if the serial number (factory stickers), manufacturing date or model name on the device have been removed, erased, damaged, altered or is illegible in any way;
- in case of violation of the rules and conditions of operation, as well as the installation of the device, set forth in the operating manual;
- cracks and scratches as well as other defects resulting from transportation, operation by the purchaser or negligent handling on his part;
- mechanical damage that occurs after the device has been transferred to the user, including damage caused by sharp objects, bending, crushing, dropping, etc;
- damage caused by non-compliance with standards for parameters of power, telecommunications, cable networks and external factors.

This limited warranty is the exclusive and sole warranty provided and is in lieu of any other express or implied warranties. The manufacturer makes no warranty, either express or implied, beyond the description contained herein, including an implied warranty of merchantability and fitness for a particular purpose. It remains at the discretion of the purchaser to use a faulty, defective and unacceptable device. The manufacturer shall not be liable for damages to other property due to any defects in the device, loss of use of the device, loss of time, or for any special, incidental, indirect or consequential damages, punitive damages and losses, including but not limited to commercial damages, loss of profits, loss of profits, loss of confidential or other information, loss of business or operational interruption due to the device being found to be defective, defective or deficient

NOTE

The manufacturer does not produce equipment for the field of "vital tasks". Devices for "vital tasks" include life support systems, medical equipment, implant-related medical devices, commercial transportation, nuclear equipment or systems, and any other application where equipment failure could result in personal injury or death, or property damage.

5 Storage, Transportation and Disposal of Devices

The device is not intended for use in areas exposed to hazardous and harmful factors.

Long-term storage is only permitted in the original packaging in dark, dry, clean, and well-ventilated enclosed areas. To prevent damage to the glass heating element, it is recommended to store the device in one layer, either vertically or horizontally.

In accordance with the Waste Electrical and Electronic Equipment (WEEE)* regulations, all electrical and electronic products must be collected separately at the end of their service life, and cannot be disposed of together with unsorted household waste.

Parts of worn out devices must be separated and sorted by the material type. In this way, every user can contribute to reuse, recycling and other forms of recovery of waste electrical and electronic equipment. Proper collection, recycling, and disposal of such devices will help avoid potential environmental and health impacts from the harmful substances they contain.

To dispose of the device, it must be returned to the point of sale, or to a local waste collection and recycling company recommended by the state or local authorities. Disposal is carried out in accordance with the applicable laws and regulations of the respective country.

For more details on how to properly dispose of your used device, please contact your device supplier, your waste disposal service or the local authorities responsible for waste disposal.

NOTE.

The User must comply with the temperature and humidity conditions of storage and transportation specified in the Table of technical specifications of the present Installation and Operation Manual.

* Waste Electrical and Electronic Equipment, or WEEE, means used electrical or electronic equipment, including all components, assemblies, consumables that are part of the equipment at the time it is taken out of service (including supplied batteries (if any), components containing mercury, etc.).

The device may be shipped by any kind of covered vehicles (by rail, or road or in sealed heated airplane compartments, etc.) in accordance with the requirements of current regulatory documents applicable to fragile goods sensitive to moisture.

The device and its accessories shall be kept in original packaging during transportation.

Similar conditions shall apply to the device storage at the Seller's warehouse.

If you need to move the assembled device, you should hold it by legs for floor installation.

Do not dispose of the device together with unsorted municipal waste as this would be harmful to the environment.

For the device disposal purposes, it shall be returned to the point of sale or to the local processing center.

For detailed information on recycling of the present device, please contact your waste management company.

6 Other Information

Information about the manufacturer

Name	ASBISc Enterprises PLC
Address	Iapetou 1, Agios Athanasios, 4101 Limassol, Cyprus
Contact info	Tel.: +357-25857090 asbis.com

Information about the importing company

Name	ASBISc Enterprises PLC
Address	Iapetou 1, Agios Athanasios, 4101 Limassol, Cyprus
Contact info	Тел.: +357-25857090 asbis.com

Quality Claims Acceptance and Warranty Service Company

The list of such companies is updated from time to time, so the latest data is posted on the aeno.com website in the “Service and Warranty” Section.

Info on Certificates and Declarations

Certificates	Certificate of conformity TUV NORD 2207604707E/L22/87020 as of August 22, 2022 Type Examination Certificate # UA.TR.130.0853-22 as of 02.09.2022
Declarations	CE Declaration of Conformity as of August 17, 2022 RoHS Declaration of Conformity as of August 17, 2022 UKCA Declaration of Conformity as of July 18, 2022 Declaration of Conformity LVD, EMC, RED # 310820020001 as of August 31, 2022 Declaration of Conformity with the Technical Regulations of Ukraine as of August 31, 2022
Other	Report TUV NORD 2207604707E/45045/TR/22

7 Troubleshooting

The table below shows typical errors and problems that may occur while using the device and possible solutions.

Table 5 – Typical problems and solutions

#	Problem	Possible Reasons	Solution
1	The heater does not turn on	The electric outlet is de-energized or defective; Damage to the power cable or plug	Check the mains voltage or make sure the outlet, the mains plug or the cable is in a good operating condition
2	The heater does not heat when turned on	The desired temperature is set incorrectly	Increase the desired temperature above the current room temperature
3	The heater does not respond to commands from the app	Network connection interrupted	Reconnect the device and the smartphone to the Wi-Fi hotspot
4	The heater does not respond to pushing the power button, and an audible beep sounds when it is pressed	Child lock mode is on	Turn off the mode via the app or manually by pressing the power button 5 times in 4 seconds
5	During operation, the heater beeps and the power button is blinking red	Heater tipping, i.e. panel is tilted for more than 45° from its vertical position	Return the heater to the upright position
6	The power button of the heater blinks red	Panel overheating or the mains voltage surge Panel or room temperature sensor error	Press the power button 5 times for 4 seconds
7	The heater does not warm the room well	The area of the room exceeds 30 m ² , or the	Change the location of the device or improve

#	Problem	Possible Reasons	Solution
		level of thermal insulation of the room is not sufficient	the level of thermal insulation of the room
8	The heater consumes considerably more than 160Wh	The device is used in manual mode, or the panel temperature is too high	Enable SMART mode via the mobile app and set the temperature of the heating panel to 60 °C
9	Receival of notifications from the device about excessive voltage	Power surges	Contact a service provider or contact a qualified electrician to troubleshoot wiring problems

8 Glossary

Amazon Alexa	A virtual assistant that supports voice communication and control of smart home devices
IoT	The Internet of Things is a system of Internet-connected devices able to collect and exchange data coming from built-in services
IP44	The degree of protection, which indicates that the device is only protected against occasional splashes (Small amounts of moisture). It allows the devices to be used primarily in rooms with a high level of humidity. The device with IP44 is not intended for outdoor use, as it is not protected against rain, snow or large amounts of dust
WEEE	Waste Electrical and Electronic Equipment means used electrical or electronic equipment, including all components, subassemblies, consumables that are part of the equipment at the time it is taken out of service (including supplied batteries/rechargeable batteries (if any), components containing mercury, etc.)

A E N O

SEASONAL

Ovaj dokument je originalno proizveden i objavljen od strane proizvođača, brenda AENO, i preuzet je sa njihove zvanične stranice. S obzirom na ovu činjenicu, Tehnoteka ističe da ne preuzima odgovornost za tačnost, celovitost ili pouzdanost informacija, podataka, mišljenja, saveta ili izjava sadržanih u ovom dokumentu.

Napominjemo da Tehnoteka nema ovlašćenje da izvrši bilo kakve izmene ili dopune na ovom dokumentu, stoga nismo odgovorni za eventualne greške, propuste ili netačnosti koje se mogu naći unutar njega. Tehnoteka ne odgovara za štetu nanесenu korisnicima pri upotrebi netačnih podataka. Ukoliko imate dodatna pitanja o proizvodu, ljubazno vas molimo da kontaktirate direktno proizvođača kako biste dobili sve detaljne informacije.

Za najnovije informacije o ceni, dostupnim akcijama i tehničkim karakteristikama proizvoda koji se pominje u ovom dokumentu, molimo posetite našu stranicu klikom na sledeći link:

<https://tehnoteka.rs/p/aeno-panelni-radijator-agh0002s-beli-akcija-cena/>