

Uputstvo za upotrebu

TEFAL friteza na vruć vazduh EY111B15

Tefal[®]



Tehnoteka je online destinacija za upoređivanje cena i karakteristika bele tehnike, potrošačke elektronike i IT uređaja kod trgovinskih lanaca i internet prodavnica u Srbiji. Naša stranica vam omogućava da istražite najnovije informacije, detaljne karakteristike i konkurentne cene proizvoda.

Posetite nas i uživajte u ekskluzivnom iskustvu pametne kupovine klikom na link:

<https://tehnoteka.rs/p/tefal-friteza-na-vruc-vazduh-ey111b15-akcija-cena/>



ULTRA FRY

www.tefal.com

www.moulinex.com

www.arno.com.br

www.imusa.com.co

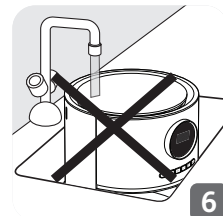
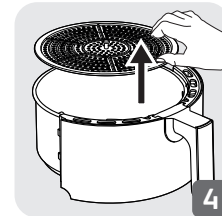
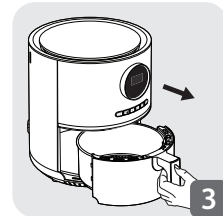
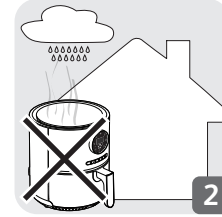
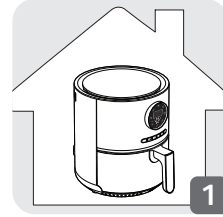
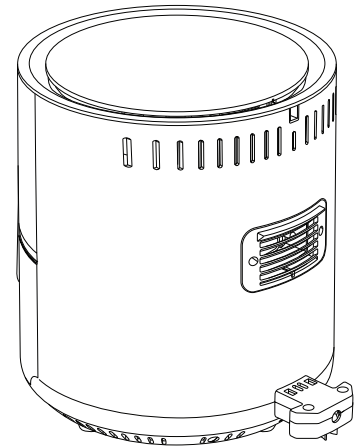



MAX 800 g



9



10



11

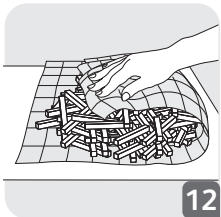

12



13



14

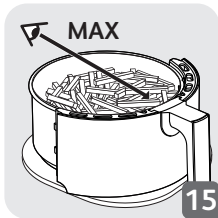

15



16



MAX 800 g



17



18

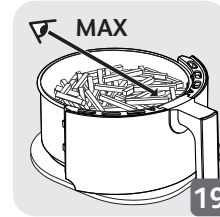







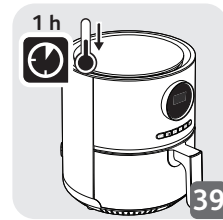
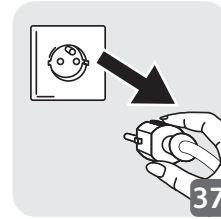
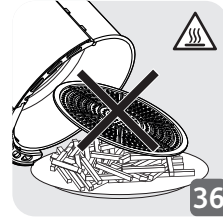
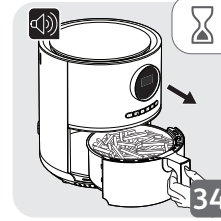
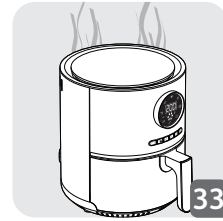
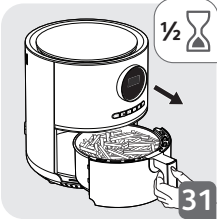
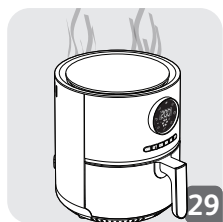
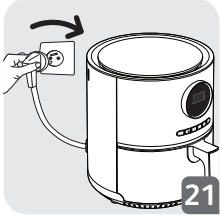

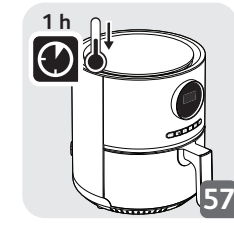
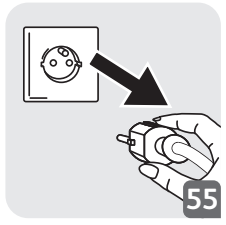
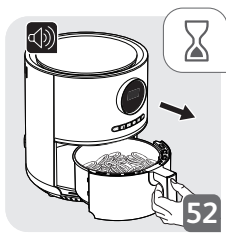
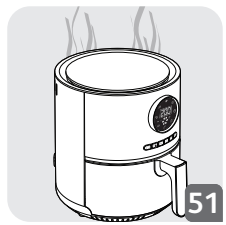
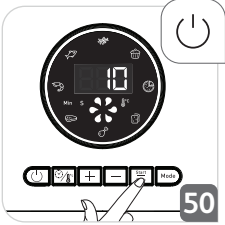
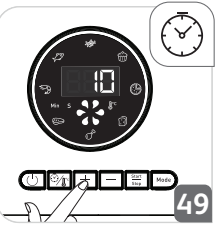
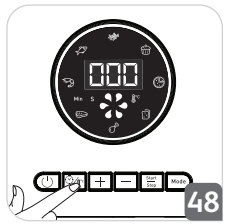
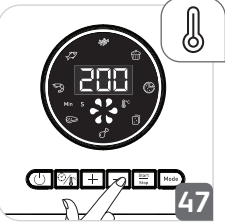
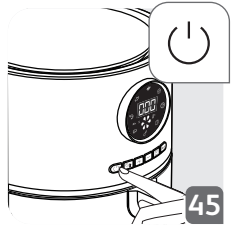
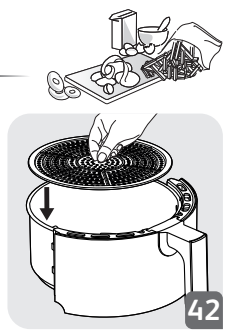
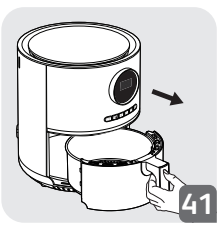
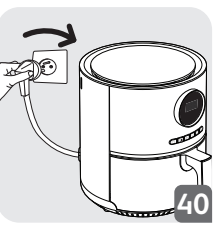

























19



20





						
	300 g - 800 g	15 - 25 min	200°C	✓		
	300 g - 800 g	22 - 27 min	200°C	✓		
	300 g - 800 g	22 - 32 min	200°C	✓		
	300 g - 700 g	16 - 20 min	200°C	✓		
	100 g - 500 g	12 - 20 min	180°C			
	1000 g	60 min	180°C			
	100 g - 600 g	7 - 15 min	180°C	✓		
	100 g - 500 g	8 - 12 min	180°C	✓		
	200g	8 - 10 min	200°C	✓		
	400 g	15 min	200°C			
	350 g	15 - 17 min	140°C			
	12 pieces	8 min	180°C			
	7 pieces	16 - 20 min	160°C			
	2 pieces	4 - 5 min	180°C			

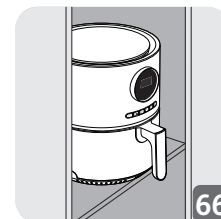
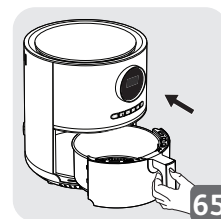
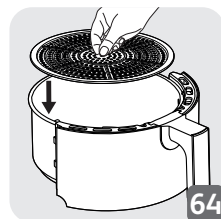
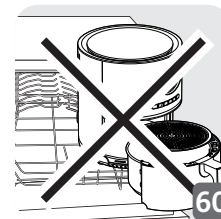
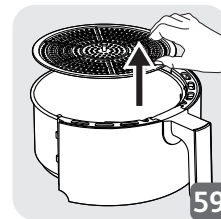
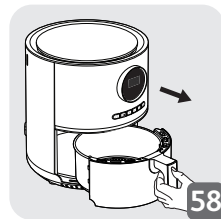

7



66

Ovaj dokument je originalno proizveden i objavljen od strane proizvođača, brenda Tefal, i preuzet je sa njihove zvanične stranice. S obzirom na ovu činjenicu, Tehnoteka ističe da ne preuzima odgovornost za tačnost, celovitost ili pouzdanost informacija, podataka, mišljenja, saveta ili izjava sadržanih u ovom dokumentu.

Napominjemo da Tehnoteka nema ovlašćenje da izvrši bilo kakve izmene ili dopune na ovom dokumentu, stoga nismo odgovorni za eventualne greške, propuste ili netačnosti koje se mogu naći unutar njega. Tehnoteka ne odgovara za štetu nanесenu korisnicima pri upotrebi netačnih podataka. Ukoliko imate dodatna pitanja o proizvodu, ljubazno vas molimo da kontaktirate direktno proizvođača kako biste dobili sve detaljne informacije.

Za najnovije informacije o ceni, dostupnim akcijama i tehničkim karakteristikama proizvoda koji se pominje u ovom dokumentu, molimo posetite našu stranicu klikom na sledeći link:

<https://tehnoteka.rs/p/tefal-friteza-na-vruc-vazduh-ey111b15-akcija-cena/>