

## Uputstvo za upotrebu (EN)

TCL QLED televizor 43C735

# TCL



Tehnoteka je online destinacija za upoređivanje cena i karakteristika bele tehnike, potrošačke elektronike i IT uređaja kod trgovinskih lanaca i internet prodavnica u Srbiji. Naša stranica vam omogućava da istražite najnovije informacije, detaljne karakteristike i konkurentne cene proizvoda.

Posetite nas i uživajte u ekskluzivnom iskustvu pametne kupovine klikom na link:

<https://tehnoteka.rs/p/tcl-qled-televizor-43c735-akcija-cena/>



## Safety

Ensure that your domestic mains supply voltage matches the voltage indicated on the identification sticker located at the back of your set. Where the mains plug, AC inlet or an appliance coupler is used as disconnect device, it shall remain readily operable.

On certain models, the light indicator is located at the side of the TV set. The absence of a light indication at the front does not mean that the TV set is fully disconnected from the mains. To disconnect the TV set completely, the mains plug must be pulled out.

The TV set's components are sensitive to heat. The **maximum ambient temperature** should not exceed **35° Celsius**. Do not cover the vents at the back or sides of the TV set. Leave sufficient space around it to allow adequate ventilation. Install the appliance away from any source of heat (fireplace, etc.) or appliances creating strong magnetic or electric fields.

**Moisture** in rooms where the set is installed should not exceed **75%** humidity. Moving the set from a cold place to a warm one can cause condensation on the screen (and on some components inside the TV set). Let the condensation evaporate before switching the TV set on again.

The  or **POWER**/ button on the TV set or the  button on the remote control can be used to switch it on and put it into standby mode. If you are **not going to be watching the TV for a lengthy period of time**, switch it off completely by removing the plug from the mains power socket.

During **thunderstorms**, we recommend that you disconnect the TV set from the mains and aerial so that it is not affected by electrical or electromagnetic surges that could damage it. For this reason, keep the **mains and aerial sockets** accessible so they can be **disconnected**, if necessary.

**Unplug** the TV set immediately if you notice it giving off a **smell of burning** or **smoke**. You must never, under any circumstances, open the TV set yourself, as you run the risk of an **electric shock** in doing so.

## WARNINGS

This appliance is intended for domestic household use only and should not be used for any other application, such as for non-domestic use or in a commercial environment.

If the external flexible cable or cord of this product is damaged, it shall be replaced by the manufacturer or his service agent or a similar qualified person in order to avoid a hazard.

Leave more than 10cm clearance around the television to allow adequate ventilation. The ventilation should not be impeded by covering the ventilation openings with items, such as newspapers,

table-cloths, curtains, etc.

The apparatus shall not be exposed to dripping or splashing and no objects filled with liquids, such as vases shall be placed on the apparatus.

Batteries (battery pack or batteries installed) shall not be exposed to excessive heat such as sunshine, fire or the like.

To reduce the risk of fire or electric shock, do not expose this apparatus to rain or moisture.

A television set may fall, causing serious personal injury or death. Many injuries, particularly to children, can be avoided by taking simple precautions such as:

- ALWAYS use cabinets or stands or mounting methods recommended by the manufacturer of the television set.
- ALWAYS use furniture that can safely support the television set.
- ALWAYS ensure the television set is not overhanging the edge of the supporting furniture.
- ALWAYS educate children about the dangers of climbing on furniture to reach the television set or its controls.
- ALWAYS route cords and cables connected to your television so they cannot be tripped over, pulled or grabbed.
- NEVER place a television set in an unstable location.
- NEVER place the television set on tall furniture (for example, cupboards or bookcases) without anchoring both the furniture and the television set to a suitable support.
- NEVER place the television set on cloth or other materials that may be located between the television set and supporting furniture.
- NEVER place items that might tempt children to climb, such as toys and remote controls, on the top of the television or furniture on which the television is placed.

If the existing television set is going to be retained and relocated, the same considerations as above should be applied.

Equipment with this symbol is a Class II or double insulated electrical appliance. It has been designed in such a way that it does not require a safety connection to electrical earth.



Equipment without this symbol is a Class I electrical appliance. It shall be connected to a mains socket outlet with a protective earthing connection.



To prevent the spread of fire, keep candles or other open flames away from this product at all times.



This symbol indicates that high voltage is present inside. It is dangerous to make any kind of contact with any internal part of this product.



This symbol indicates that the fuse may be in the neutral, and that the mains shall be disconnected to de-energize the phase conductors.

To prevent injury, this apparatus must be securely attached to the floor/wall in accordance with the installation instructions.

To reduce the risk of RF exposure, the use distance of this apparatus should be at least 100cm.

If an outside antenna or cable system is connected to the product, be sure the antenna or cable system is grounded by a skilled person so as to provide some protection against voltage surges and built-up static charges.

### TV screen

The TV screen used in this product is made of glass. Therefore, it can break when the product is dropped or impacted upon by other objects.

The TV screen is a very high technology product, giving you finely detailed pictures. Occasionally, a few nonactive pixels may appear on the screen as a fixed point of blue, green or red. This does not affect the performance of your product.

### Care

Use a glass-cleaning product to clean the screen and a soft cloth and mild detergent to clean the rest of the set.

**Important:** Using strong detergents, alcohol-based and abrasive products may damage the screen.

Dust the vents at the back and sides regularly. Using solvents, abrasive or alcohol-based products could damage the TV set. If an object or liquid enters the appliance, unplug it immediately and have it checked by an authorized engineer. Never open the appliance yourself since this may put you at risk or damage the appliance.

### ESD regulation

This apparatus meets ESD performance criteria. In case the apparatus does not recover in Ethernet connection mode or USB playing mode due to electrostatic discharge, user intervention is required.

### Bluetooth function notice

Bluetooth® technology (if available in your TV) uses 2.4GHz frequency thus close proximity to Wi-Fi access points, routers or microwave ovens might interfere with Bluetooth audio streaming. If you face

interruptions in audio reception, you should restart your Bluetooth device to find frequency with less interferences and if you continue to face issues you should move closer to TV or increase space between TV and source of interferences.

Bluetooth declaration ID: D056959

### Hanging the TV set on the wall

**Warning: This operation requires at least two people depending on your TV dimension.**

To ensure a safe installation, observe the following safety notes:

- Check that the wall can support the weight of the TV set and wall mount assembly.
- Follow the mounting instructions provided with the wall mount. For certain models, make sure to screw the hexagonal VESA wall mounting screw bosses (and screws) provided with the set into the nuts for the wall mount at the back of your set before your wall mounting.
- The TV set must be installed on a vertical wall.
- Make sure to use only screws suitable for the material of the wall.
- Make sure that the TV set cables are placed so that there is no danger of tripping over them.

All other safety instructions about our TV sets are also applicable here.

### Multi product user manual

The features described in this manual are common to most models. Some features may not be available on your TV and/or your TV may include features that are not described in this user manual. The illustrations in this manual may differ from the actual product. Please refer to the actual product.

### Device update

Typically, some devices are updated quarterly, but not always so specific. Some devices, especially those that went on sale more than three years ago, will only be updated if a critical vulnerability is found and fixed.

**Information for Users on Disposal of Old Equipment and Batteries****[European Union]**

Products

These symbols indicate that the electrical and electronic equipment and the battery with this symbol should not be disposed of as general household waste at their end-of-life. Instead, the products should be handed over to the applicable collection points for the recycling of electrical and electronic equipment as well as batteries for proper treatment, recovery and recycling in accordance with your national legislation and the Directive 2012/19/EU, 2006/66/EC and 2008/12/EC.

**Pb**  
Battery

**Notice:**  
The sign Pb below the symbol for batteries indicates that this battery contains lead.

By disposing of these products correctly, you will help to conserve natural resources and will help to prevent potential negative effects on the environment and human health which could otherwise be caused by inappropriate waste handling of these products.

For more information about collection points and recycling of these products, please contact your local municipal office, your household waste disposal service or the shop where you purchased the product.

Penalties may be applicable for incorrect disposal of this waste, in accordance with national legislation.

**[Business users]**

If you wish to dispose of this product, please contact your supplier and check the terms and conditions of the purchase contract.

**[Other Countries outside the European Union]**

These symbols are only valid in the European Union. If you wish to dispose of these items, please do so in accordance with applicable national legislation or other rules in your country for the treatment of old electrical equipment and batteries.

**Dear Customer,**

Hereby, TCL declares that this device is in compliance with Directive 2014/53/EU. The full text of the EU declaration of conformity is available at the following internet address: [www.tcl.com](http://www.tcl.com)

The EU declaration of conformity can be downloaded directly at [www.tcl.eu/eu/doc/XXXXXXXXX](http://www.tcl.eu/eu/doc/XXXXXXXXX) \*

\* Please replace «XXXXXXXXX» by the exact model name.

*Figures and illustrations in this User Manual are provided for reference only and may differ from actual product appearance. Product design and specifications may be changed without notice.*

Important information .....	1
<b>Chapter 1 - Connections</b>	
Connect the power and antenna .....	5
Connect Blu-ray Disc player, HD game console, HD camcorder, headphones, CI module .....	5
Connect to the Internet .....	6

## Chapter 2 - Getting started

Exclusive Remote control .....	7
Installing batteries .....	7
Additional remote control .....	8
Installing batteries .....	8
Switch the TV on and off .....	9
Initial setup .....	9

## Chapter 3 - Basic TV operations

Remote control buttons .....	10
Accessing channels .....	10
Watching connected devices .....	10
Adjusting volume .....	10
Accessing Smart TV homepage .....	10
Using Settings menu .....	10

## Chapter 4 - Using more of your TV

Installing channels .....	11
Common interface .....	11
Using the common interface module .....	11
Accessing common interface services .....	11
Using subtitles .....	11
Turning on/off subtitles .....	11
Enabling subtitle languages on digital TV channels .....	11
Selecting a subtitle type on digital TV channels .....	12
Using Teletext .....	12
Selecting decoding page language .....	12
Digital Teletext language .....	12
Consumer Electronic Control (CEC) .....	12
Enabling or disabling CEC .....	12
Using Auto power on .....	12
Using Auto standby .....	12
HbbTV .....	12
HbbTV access .....	12
HbbTV deactivation .....	13

Using EPG (Electronic Programme Guide) .....	13
Bluetooth function .....	13
Quick start function .....	13
Networked waking up .....	13
Reset to factory default settings .....	14
Using the hands-free TV voice control .....	14

## Chapter 5 - Other information

Password in Parental Control .....	15
Troubleshooting .....	15

# Chapter 1 - Connections

## Connect the power and antenna

To switch on TV after connecting power cord, press  $\text{\textcircled{P}}$  or **POWER/**.

Notes:

- Position of power socket varies according to TV model.
- Disconnect the power cord before connecting devices.

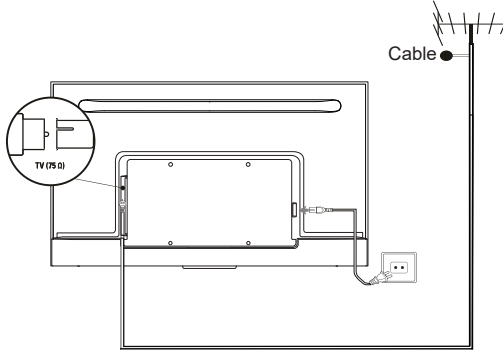

## Connect Blu-ray Disc player, HD game console, HD camcorder, headphones, CI module

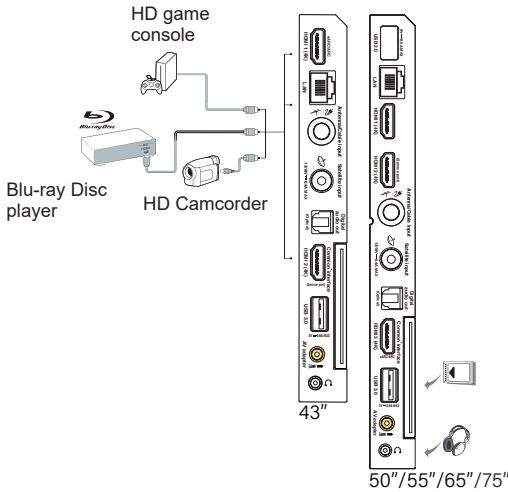

## Connect to the Internet

*Note: The following instructions are just the usual ways to connect your TV to the wired or wireless network. The connection method may be different depending on your actual network configuration. If you have any questions about your home network, please refer to your Internet service provider.*

### Wired connection

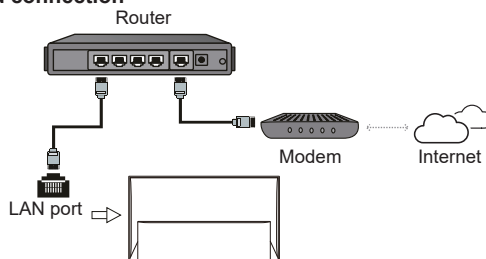

### Wireless connection

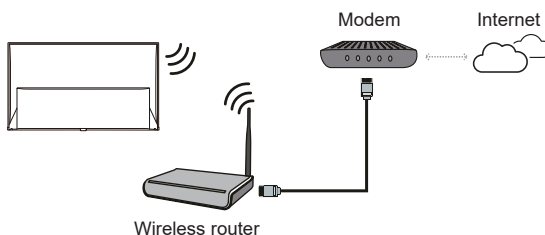

### Network settings:

1. Press **Home** on the remote control to display the Smart TV homepage.
2. Press **Up/Down/Left/Right** to move the cursor to **Settings** on the right top of the screen and press **OK** to enter the **Settings** menu.
3. Press **Up/Down** to select **Network and Internet**, press **OK** to enter the submenu and follow the on-screen guidance to set up your network.

### Notes:

- Your TV might not have all connectors visible on diagram above. Number of USB and HDMI ports may vary according to TV model.
- Button and connector locations may vary according to TV model.
- USB connectors are for data input from USB drives and for connecting other relevant USB devices where applicable.
- All USB devices have to be directly connected to TV set without cable extenders. In case extender is required, maximum 50cm length is recommended. Longer extenders should have ferrite beads.
- ARC (Audio Return Channel) function is only supported on the HDMI port identified with ARC. To use ARC function, please turn on **CEC** function first as described in the **CEC** section.
- It is recommended to use high quality and well shielded HDMI cables to avoid possible interferences.
- Please use headphones with 3.5mm TRS connector. Excessive sound pressure from headphones can cause hearing loss.

## Exclusive Remote control

Most of your television's functions are available via the menus that appear on the screen. The remote control supplied with your set can be used to navigate through the menus and to configure all the general settings.



- To switch the sound off and back on.
- Standby / quit standby.
- Add an entity to Watchlist. (Available only in Google TV mode.)
- Press the **Google Assistant** button on your remote to talk to the Google Assistant. (Available only in Google TV mode and when the network connection is normal.)
- To display the dashboard menu.
- Circular D-Pad** Navigation direction buttons.
- OK** To confirm an entry or selection. (Available to display the channel list in TV mode.)
- To return to the previous menu or quit an App.
- To access the Smart TV homepage.
- To access the Electronic Programme Guide (only available for digital channels).
- To select input source.
- To control the volume.
- P+/P-** To change channels.
- To display the Quick Settings panel. Or to perform the corresponding function as indicated on screen.
- To display the quick panel.
- To pop up the virtual remote control keyboard when available.
- To open TCL home on screen.
- NETFLIX** To access Netflix if available.
- prime video** To access Prime video if available.
- Guard** To access Safety Guard if available.
- Media** To access Media Player if available.
- Youtube** To access YouTube if available.
- TCL CHANNEL** To access TCL Channel.

### Notes:

- This remote control is available only for selected models. The remote control type may be changed without notice.
- Certain function may be accessed from the virtual remote control keyboard only, please press button on the remote to display it and operate accordingly.
- The App buttons may differ depending on the model. The App button is used for accessing the corresponding App.
- Follow the on-screen guide to pair the remote control with the TV when pressing the **Google Assistant** button for the first time.
- Google TV is the name of this device's software experience and a trademark of Google LLC.
- The Google Assistant is not available in certain languages and countries.

### Installing batteries

1. Push to open the back cover as illustrated.
2. Insert two AAA batteries according to the polarities marked on the batteries case.
3. Replace the back cover as illustrated.

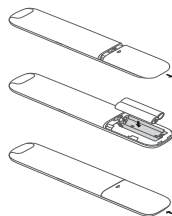

Note: The remote control type may be changed without notice.



## Additional remote control



To switch the sound off and back on.

Standby / quit standby.

**Numeric buttons** To enter channel numbers or a digit.

To access TCL Channel.

**LIST** Add an entity to Watchlist. (Available only in Google TV mode.)

To control the volume.

To display programme information, if available.

To display the dashboard menu.

To change channels.

To access the Smart TV homepage.

To display the Quick Settings panel. Or to perform the corresponding function as indicated on screen.

Navigation direction buttons.

**OK** To confirm an entry or selection.

To return to the previous menu or quit an App.

To select input source.

**EXIT** To exit the on-screen menu.

**LANG** To select an audio language available for selected digital TV programme.

**GUIDE** To toggle the Electronic Programme Guide on or off (only available for digital channels).

**TEXT** To toggle Teletext on or off.

**SUBT.** To select a subtitle language available for selected digital TV programme.

**Colour buttons** To select tasks or Teletext pages; to be used for HbbTV function.

To start fast reverse.

To pause playback.

To start fast forward.

**ZOOM** To select the screen mode.

*Note: You are recommended to use the full screen mode.*

*Do not use the display mode with black bars on both sides of the picture (such as 4:3) for a long time; otherwise the TV screen may be damaged permanently.*

To start playback.

To stop playback.

**NETFLIX** To access Netflix if available.

**prime video** To access Prime video if available.

### Installing batteries

1. Push to open the back cover as illustrated.
2. Insert two AAA batteries according to the polarities marked on the battery case.
3. Replace the back cover as illustrated.

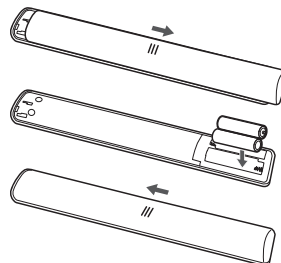

**Important:**

Batteries shall not be exposed to excessive heat such as sunshine, fire or the like. Remove batteries when the remote control is not to be used for a long time. Batteries left in equipment may cause damage through deterioration and corrosive leakage, invalidating the guarantee.

To protect the environment use local recycling facilities for battery disposal. Dispose of used batteries according to the instructions.



**CAUTION:** Risk of explosion if batteries are replaced by an incorrect type. Replace only with the same or equivalent type recommended by the equipment manufacturer.

If the batteries in your remote control are run down, you can use the button on your TV set.

You can turn on the TV from standby mode by pressing the  button on your TV set.

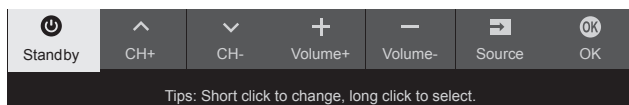



While the TV is on, the multi-function menu appears by pressing the  button on your TV set. For more information about how to use the multi-function menu, please refer to the figure below.



- Press the  button to move the highlight to the next function selection.
- Press and hold the  button for more than 2 seconds to confirm your selection.

*Note: Please refer to the Quick Start Guide to find the  button on your TV set.*

## Switch the TV on and off

1. When the power cord is connected, the TV will be turned on directly or be in standby mode. If the TV is in standby mode, press the  or **POWER**/ button on the set or the  button on the remote control to turn it on.
2. To put the TV into standby mode, press the  button on the remote control. The TV set remains powered up, but with low energy consumption.
3. To switch the TV off, unplug the mains plug from the mains outlet.

*Note: In order to save energy and protect environment, certain models are designed with a relay switch. It is normal phenomenon if you hear the sound of the relay when you turn on or off the TV set.*

## Initial setup

The first time you switch the set on, the **Welcome** screen appears, which guides you through the initial setup process. Follow the on-screen instructions to finish the initial setup process such as selecting the language, connecting to the network, scanning channels, and more. During each step, either make a choice or skip the step. If you skip a step, you can perform the setup later from the settings menu.

*Note: If the channel search retrieved only the analogue channels it could be caused by poor broadcasting and therefore is not covered by manufacturer warranty. Manufacturers cannot be held responsible for lack of or poor broadcasting in some areas.*

## Chapter 3 - Basic TV operations

### Remote control buttons

Here are the navigation direction buttons and the **OK** button on the remote control that you may use frequently.





### Accessing channels

**Using the Navigation Direction buttons:** press **▲/▼** on the remote control to scroll through the channels.

**Using the OK button:** press the **OK** button to display the channel list and press **▲/▼/◀/▶** and **OK** to select channels.

**Using the P+/P- buttons:** press the **P+/P-** buttons on the remote control to scroll through the channels.

**Using the  button:** press  to display the virtual remote control keyboard, then you can use the numeric buttons, or the **List** button to operate accordingly.

### Watching connected devices

Press  on the remote control to display the source list. Press **▲/▼** to select TV or other input sources and press **OK** to confirm.

### Adjusting volume

**Volume control:** press the **+/-** buttons on the remote control to increase or decrease the volume.

**Sound mute:** press the  button to temporarily mute the sound. Press this button again or the **+/-** button to restore the sound.

### Accessing Smart TV homepage

Allows you to enjoy Internet Applications (Apps) and specially adapted Internet websites, and perform system settings for your TV. You can make controlling with the TV remote control.

#### WARNING:

- Configure the network settings before using Smart TV applications.
- Slow responses and/or interruptions may occur, depending on your network conditions.
- If you experience a problem using an application, please contact the content provider.
- According to circumstances of the content provider, an application's updates or the application itself may be discontinued.

- Depending on your country's regulations, some applications may have limited service or not be supported.
- Changes in application content may be made without prior notice by the service provider.

1. Press  on the remote control to display the Smart TV homepage.
2. Press **▲/▼/◀/▶** and **OK** to enter the desired Apps, functions or settings.
3. Press **←** to return to the homepage.

*Note: Since the connection with Internet takes time, it's recommended that you wait a few minutes to use the Smart TV feature after activation of TV from standby.*

### Using Settings menu

Allows you to adjust TV settings, such as picture and sound.

1. Press  on the remote control to display the dashboard menu.
2. Select **Settings** and press **OK** to enter the settings menu.
3. In submenus, press **▲/▼** to select menu options, then press **OK/▶** to enter the option list, or the corresponding submenu, or press **OK** to toggle on or off, or press **◀/▶** to adjust the setting.
4. Press **←** to return to the previous menu.

*Note: Setting **LED motion clear** on will make fast moving images clearer by controlling the **LED backlight**, but the picture will be darker and more flickering than with **LED motion clear off**.*

## Installing channels

This section describes how to search and store channels automatically. This may be done in any of the cases below:

- you have skipped the channel installation step in the initial setup;
- you are prompted that there are no channels in TV mode;
- you want to update your channels.

1. In TV mode, press **⚙** on the remote control and select **Settings > Channels and inputs > Channel > Channel scan**. Press **OK/▶** to enter.
2. The TV installs and arranges channels according to your country or region. Press **▲/▼** to select **Country/Region**, and press **OK/▶** to enter. Enter the default password 1234 or your own password in case you have changed the password in the **System > Lock** menu. Press **▲/▼** to select your country or region and press **OK** to confirm.
3. Press **▲/▼** to select **Automatic search** and press **OK/▶** to enter.
4. Press **▲/▼** to select **Tuner mode** and press **◀/▶** to select **Cable, Antenna or Satellite**.  
(Note: **Satellite** option is available only in selected models.)
5. Press **▲/▼** to select other options to configure.
6. After configuration is completed, press **▼** to select **Search** and press **OK** to start scanning channels.
7. The channel search may take a few minutes. After the automatic search, channels are arranged in a preset order. If you want to edit the channel list, press **⚙** on the remote control, select **Settings > Channels and inputs > Channel > Channel organizer** and press **OK** to enter.

## Common interface

Encrypted digital TV channels can be decoded with a common interface module and a card provided by a digital TV service operator.

The common interface module may enable several digital services, depending on the operator and services you choose (for example, pay TV). Contact your digital TV service operator for more information about services and terms.

### Using the common interface module

**WARNING: Switch off your TV before inserting a common interface module. Be sure to follow the instructions described below. Wrong insertion of a common interface module may damage both the module and your TV.**

1. Following the directions printed on the common interface module, gently insert the module into the common interface slot on the TV.
2. Push the module in as far as it will go.
3. Turn on the TV and wait for the common interface function to be activated. This may take several minutes.

*Note: Do not remove the common interface module from the slot. Removing the module will deactivate the digital services.*

### Accessing common interface services

After inserting and activating the common interface module, press **⚙** on the remote control, select **Settings > Channels and inputs > Channel > Common interface** and press **OK/▶** to enter.

This menu option is only available if the common interface module is correctly inserted and activated. On-screen applications and content are provided by your digital TV service operator.

## Using subtitles

You can enable subtitles for each TV channel. Subtitles are broadcast via Teletext or DVB-T/DVB-C/DVB-S/DVB-T2/DVB-S2 digital broadcasts. With digital broadcasts, you have the additional option of selecting a preferred subtitle language.

### Turning on/off subtitles

1. Press **⚙** on the remote control, select **Settings > Channels and inputs > Channel > Subtitle** and press **OK/▶** to enter.
2. Select the **Subtitle** option, and press **OK** to toggle between on or off.
3. Press **←** to return to the previous menu.

### Enabling subtitle languages on digital TV channels

1. Press **⚙** on the remote control, select **Settings > Channels and inputs > Channel > Subtitle > Digital subtitle language 1st** and press **OK/▶** to enter.
2. Press **▲/▼** to select a subtitle language as your preferred language and press **OK** to confirm.
3. Press **▲/▼** to select **Digital subtitle language 2nd** and press **OK/▶** to enter.
4. Press **▲/▼** to select a secondary subtitle language and press **OK** to confirm.
5. Press **←** to return to the previous menu.

### Selecting a subtitle type on digital TV channels

1. Press **⚙** on the remote control, select **Settings > Channels and inputs > Channel > Subtitle > Subtitle type** and press **OK/▶** to enter.
2. Press **▲/▼** to select a subtitle type and press **OK** to confirm. You can select **Hearing impaired** to display the hearing impaired subtitles with your selected language.
3. Press **←** to return to the previous menu.

## Using Teletext

### Selecting decoding page language

1. Press **⚙** on the remote control, select **Settings > Channels and inputs > Channel > Teletext > Decoding page language** and press **OK/▶** to enter.
2. Press **▲/▼** to select a proper type of language in which Teletext will display and press **OK** to confirm.
3. Press **←** to return to the previous menu.

### Digital Teletext language

On digital TV channels, depending on the broadcaster, you may be able to enjoy a service with multiple initial Teletext pages in different languages. This function allows you to select an available language as primary language, which relates to different initial Teletext pages.

1. Press **⚙** on the remote control, select **Settings > Channels and inputs > Channel > Teletext > Digital teletext language** and press **OK/▶** to enter.
2. Press **▲/▼** to select a language and press **OK** to confirm.
3. Press **←** to return to the previous menu.

## Consumer Electronic Control (CEC)

Use this function to search for CEC devices connected to the HDMI sockets in your TV and enable one-touch play and one-touch standby between CEC devices.

### Enabling or disabling CEC

1. Press **⚙** on the remote control, select **Settings > Channels and inputs > Inputs > Consumer Electronic Control (CEC)** and press **OK/▶** to enter.
2. Select the **HDMI control** option, and press **OK** to toggle between on or off.
3. Press **←** to return to the previous menu.

### Using Auto power on

Enables the TV to automatically power on when you power on a CEC device (e.g. DVD) with the device's remote. Press **OK** to turn it on to enable this function.

### Using Auto standby

Enables all CEC devices to automatically go to the standby mode when you turn off the TV with the TV remote. Press **OK** to turn it on to enable this function.

*Note: The CEC functions depend on the devices connected and it is possible that some devices may not interoperate correctly when connected to this TV. The user manual or the manufacturer of the problematic devices should be consulted for further information.*

## HbbTV

HbbTV (Hybrid broadcast broadband TV) is a service offered by certain broadcasters and available only on some digital TV channels. HbbTV delivers interactive television over broadband Internet. These interactive features are added to and enrich the normal digital programmes, and include services such as digital teletext, electronic programme guide, games, voting, specific information related to the current programme, interactive advertising, information magazines, catch-up TV, etc.

To use HbbTV please ensure your TV is connected to Internet and HbbTV is switched on.

*Notes:*

- *HbbTV services are broadcast- or country-dependent and may be unavailable in your area.*
- *You cannot download files to your TV with HbbTV function.*
- *Application provider or broadcasting related conditions may cause an HbbTV application to be unavailable momentarily.*
- *To access HbbTV applications you must connect your TV to the Internet via a broadband link. HbbTV applications may not work correctly in case of network related issues.*

### HbbTV access

1. Press **⚙** on the remote control, select **Settings > System > HbbTV settings** and press **OK/▶** to enter.
2. Select the **HbbTV** option, and press **OK** to turn it on.
3. When you tune to a digital TV channel that offers HbbTV, this will be signalled to you by an on-screen indication (generally a red button, but other colour buttons may also be used). Press the indicated colour button to open the interactive pages.

4. Use ▲/▼/◀/▶ and the colour buttons to navigate through the HbbTV pages and press **OK** to confirm.

### HbbTV deactivation

To avoid disturbances that may be caused by HbbTV broadcasting tests, you can turn off the HbbTV function:

1. Press **⚙** on the remote control, select **Settings > System > HbbTV settings** and press **OK/▶** to enter.
2. Select the **HbbTV** option, and press **OK** to turn it off to disable it.

## Using EPG (Electronic Programme Guide)

EPG is an on-screen guide that displays scheduled digital TV programmes. You can navigate, select and view programmes.

1. Press **⚙** on the remote control, select **Settings > Channels and inputs > Channel > EPG** and press **OK** to enter, or press **⏏** on the remote control (*if available*), the **Programme Guide** menu will appear, which allows you to get information about the current or next programme playing on each channel. Navigate through the different programmes using the ▲/▼/◀/▶ buttons on the remote control.
2. Use the related buttons shown at the bottom of the screen to view EPG.
  - **Watch now** or **More**: Press **OK** to watch the selected channel or view more information about the selected programme.
  - **Programme filter**: Press **☰** to display programme filter for digital TV programmes.
  - **Custom schedule**: Press **📅** on the remote control, select the red icon and press **OK** to set a schedule.
  - **Select date**: Press **📅** on the remote control, select the green icon and press **OK** to select date.
  - **Schedule list**: Press **📅** on the remote control, select the yellow icon and press **OK** to view your schedule list.
3. Press **←** to return to the previous menu.

## Bluetooth function

(\* not available for some models)

Bluetooth® is a wireless technology standard for exchanging data over short distance between Bluetooth devices. You can connect Bluetooth audio device, mouse or keyboard via the TV.

1. Press **⚙** on the remote control, select **Settings > Remotes and accessories** and press **OK/▶** to enter.
2. Select **Add accessory** and press **OK** to enter. The TV will search nearby Bluetooth devices automatically. Select an available device, press **OK** and follow the guides on the screen to connect it.

*Note: Bluetooth technology (if available in your TV) uses 2.4GHz frequency thus close proximity to Wi-Fi access points, routers or microwave ovens might interfere with Bluetooth audio streaming. If you face interruptions in audio reception, you should restart your Bluetooth device to find frequency with less interferences and if you continue to face issues you should move closer to TV or increase space between TV and source of interferences.*

The Bluetooth® word mark and logos are registered trademarks owned by Bluetooth SIG, Inc. and any use of such marks by TTE Corporation is under license. Other trademarks and trade names are those of their respective owners.

## Quick start function

It enables you to turn on your TV faster from standby mode than turning this function off, but it will also increase standby power consumption.

1. Press **⚙** on the remote control, select **Settings > System > Power and energy > Quick start** and press **OK/▶** to enter.
2. Select the **Quick start** option and press **OK** to toggle between on and off.
3. Press **←** to return to the previous menu.

## Networked waking up

This function allows you to turn on your TV from standby mode via a network. To use this function, please make sure:

1. Your TV is connected to an effective wireless home network;
2. The desired controller, such as a smartphone, is connected to the same wireless network as your TV;
3. An App which supports networked waking up function, such as Youtube, has been installed into the controller;
4. In Google TV mode, press **⚙** on the remote control, select **Settings > Network and Internet > Networked standby** and press **OK** to turn it on.

When the TV is in networked standby mode, you can use the App to wake up the TV remotely.

**Notes:**

- This feature is disabled if you press and hold the  button on the remote control and confirm to shut the TV down.
- Before using the feature of networked waking up, make sure the **Quick start** function is enabled.
- This function may not be available for certain models.
- This feature is only available in Google TV mode.

**energy** menu to enjoy hands-free voice control in TV standby mode.

- Standby power consumption will increase because the built-in MIC is always listening when the Google Assistant or voice control with the built-in MIC is enabled.
- This feature is only available in Google TV mode.

## Reset to factory default settings

Allows you to reset the TV to factory default settings.

1. Press  on the remote control, select **Settings > System > About > Reset > Factory reset > Delete everything** and press **OK** to confirm.
2. Use the numeric buttons on the remote control to enter the password 1234 or your own password in case you have changed it.
3. Select **OK** and press **OK** to confirm.
4. The **Welcome** screen appears. Follow the instructions in the section **Initial setup**.

## Using the hands-free TV voice control

Before using the hands-free TV voice control, connect the TV to the network and make sure it can access the Google website first. Then follow the steps below to access.

1. Turn the built-in MIC switch (Please refer to the Quick Start Guide to find the MIC switch on your TV set) to on before using this function.
2. Press  on the remote control and follow the on-screen guide to finish pairing the remote control with the TV.
3. Select "Yes, I'm in".
4. Say "OK Google" or "Hey Google" to activate it.

**Notes:**

- This hands-free TV voice control is only available for selected models. For details, please refer to your local dealer.
- A quiet surrounding is required for better function when using it. The recommended distance for using the hands-free TV voice control is within 2 meters in front of it.
- Turn the built-in MIC switch to off if you are not going to use it.
- The availability of hands-free TV voice control depends on your region/country/language.
- Turn on both **Quick start** and **Screenless service** in the **Settings > System > Power and**

## Password in Parental Control

- The default password is 1234. You can change it to a new one.
- The super password is 0423. If you forget your code, enter the super password to override any existing codes.

## Troubleshooting

Please check the following list before requesting service.

### There is no picture or sound.

- Make sure the power cord is properly inserted in the power outlet.
- Make sure the source type is set correctly.
- Make sure the antenna is properly connected.
- Make sure the volume is not set to minimum or the sound is not set to mute.
- Make sure the headphones are not connected.
- The TV may be receiving a signal other than from TV broadcasting stations.

### Picture is not clear.

- Make sure the antenna cable is properly connected.
- Consider whether your TV signal is being properly received.
- Poor picture quality can occur due to a VHS camera, camcorder, or other peripheral being connected at the same time. Switch off one of the other peripherals.
- The 'ghost' or double image may be caused by obstruction to the antenna due to high-rise buildings or hills. Using a highly directional antenna may improve the picture quality.
- The horizontal dotted lines shown on the pictures may be caused by electrical interference, e.g., hair dryer, nearby neon lights, etc. Turn off or remove these.

### Picture is too dark, too light or tinted.

- Check the colour adjustment.
- Check the brightness setting.
- Check the sharpness function.

### Remote control does not work.

- Check the batteries of the remote control.
- Make sure the remote sensor window on the TV front is not under strong fluorescent lighting.
- Try to clean the remote sensor window on the TV front with a soft cloth.

If the above suggestions do not solve your technical issue, please refer to the warranty card for service information.

## Operating Conditions

Temperature 5°C - 35°C (41°F - 95°F)  
Humidity 20 - 75% (non-condensing)

## Storage Conditions

Temperature -15°C - 45°C (5°F - 113°F)  
Humidity 10 - 90% (non-condensing)

## Radio Information

- Bluetooth® transmitter frequency range: 2402 - 2480MHz
  - Bluetooth® transmitter power: 6dBm (+/-4dB)
  - 2.4G Wi-Fi transmitter frequency range: 2412 - 2472MHz
  - 2.4G Wi-Fi transmitter power: 14dBm (+/-2dB)
  - 5G Wi-Fi transmitter frequency range:
    - Band 1: 5180-5240MHz
    - Band 4: 5745-5825MHz
  - 5G Wi-Fi transmitter power: 14dBm (+/-2dB)
  - DVB-T/T2/C tuner frequency range: 50.5 - 858MHz
  - DVB-S/S2 tuner frequency range: 950 - 2150MHz
- \* In all EU member states, operation of 5180 - 5240MHz is restricted to indoor use only.

	BE	BG	CZ	DK	DE	EE	IE
	EL	ES	FR	HR	IT	CY	LV
	LT	LU	HU	MT	NL	AT	PL
	PT	RO	SI	SK	FI	SE	UK

## OSS Notice

This product uses the GPL (Version 2 and 3) and LGPL (version 2.1) and MPL (version 1.1).

To send inquiries and requests for questions regarding open source, contact nearest TCL office.

This product uses some software programs which are distributed under the Independent JPEG Group.

This product uses some software programs which are distributed under the libpng Project.

This product uses some software programs which are distributed under the Freetype Project.

This product uses some software programs which are distributed under the zlib Project.

This product uses some software programs (libxml2, curl, expat, c-areas) which are distributed under the MIT.

This product uses CyberLink for C which is distributed under the Open Source Project.

This product uses openssl, xerces which is distributed under the Apache License Project.

GPL software: Linux Kernel, glib, libiconv, gcc libgcc, gcc libstdc++, u-Boot loader, ffmpeg, util-linux-ng, e2fsprogs, wget, iptables



LGPL software: DFB (DirectFB), gstreamer, gst-plugins-base, gst-plugins-good, gst-plugins-bad, gst-plugins-ugly, gst-ffmpeg, glibc, wpa\_supplicant  
 BSD software: webp, mng, uriparser  
 GNU software: dosfstools

### **[Legal Statement] of TCL - manufacturer of this TV set**

Due to the various capabilities of products featuring the SmartTV - Services, as well as limitations in the available content, certain features, applications, and services may not be available on all devices or in all territories. Some features on SmartTV may also require additional peripheral devices or membership fees that are sold separately. Please visit our website for more information on specific device information and content availability. The services and availability of content through SmartTV are subject to change from time to time without prior notice.

All content and services accessible through this device belong to third parties and are protected by copyright, patent, trademark and/or other intellectual property laws. Such content and services are provided solely for your personal noncommercial use. You may not use any content or services in a manner that has not been authorized by the content owner or service provider. Without limiting the foregoing, unless expressly authorized by the applicable content owner or service provider, you may not modify, copy, republish, upload, post, transmit, translate, sell, create derivative works, exploit, or distribute in any manner or medium any content or services displayed through this device.

YOU EXPRESSLY ACKNOWLEDGE AND AGREE THAT USE OF THE DEVICE IS AT YOUR SOLE RISK AND THAT THE ENTIRE RISK AS TO SATISFACTORY QUALITY, PERFORMANCE AND ACCURACY IS WITH YOU. THE DEVICE AND ALL THIRD PARTY CONTENT AND SERVICES ARE PROVIDED "AS IS" WITHOUT WARRANTY OF ANY KIND, EITHER EXPRESS OR IMPLIED. TCL EXPRESSLY DISCLAIMS ALL WARRANTIES AND CONDITIONS WITH RESPECT TO THE DEVICE AND ANY CONTENT AND SERVICES, EITHER EXPRESS OR IMPLIED, INCLUDING BUT NOT LIMITED TO, WARRANTIES OF MERCHANTABILITY, OF SATISFACTORY QUALITY, FITNESS FOR A PARTICULAR PURPOSE, OF ACCURACY, OF QUIET ENJOYMENT, AND NON-INFRINGEMENT OF THIRD PARTY RIGHTS. TCL DOES NOT GUARANTEE THE ACCURACY, VALIDITY, TIMELINESS, LEGALITY, OR COMPLETENESS OF ANY CONTENT OR SERVICE MADE AVAILABLE THROUGH THIS DEVICE AND DOES NOT

WARRANT THAT THE DEVICE, CONTENT OR SERVICES WILL MEET YOUR REQUIREMENTS, OR THAT OPERATION OF THE DEVICE OR SERVICES WILL BE UNINTERRUPTED OR ERROR-FREE. UNDER NO CIRCUMSTANCES, INCLUDING NEGLIGENCE, SHALL TCL BE LIABLE, WHETHER IN CONTRACT OR TORT, FOR ANY DIRECT, INDIRECT, INCIDENTAL, SPECIAL OR CONSEQUENTIAL DAMAGES, ATTORNEY FEES, EXPENSES, OR ANY OTHER DAMAGES ARISING OUT OF, OR IN CONNECTION WITH, ANY INFORMATION CONTAINED IN, OR AS A RESULT OF THE USE OF THE DEVICE, OR ANY CONTENT OR SERVICE ACCESSED BY YOU OR ANY THIRD PARTY, EVEN IF ADVISED OF THE POSSIBILITY OF SUCH DAMAGES.

Third party services may be changed, suspended, removed, terminated or interrupted, or access may be disabled at any time, without notice, and TCL makes no representation or warranty that any content or service will remain available for any period of time. Content and services are transmitted by third parties by means of networks and transmission facilities over which TCL has no control. Without limiting the generality of this disclaimer, TCL expressly disclaims any responsibility or liability for any change, interruption, disabling, removal of or suspension of any content or service made available through this device. TCL may impose limits on the use of or access to certain services or content, in any case and without notice or liability. TCL is neither responsible nor liable for customer service related to the content and services. Any question or request for service relating to the content or services should be made directly to the respective content and service providers.

Ovaj dokument je originalno proizveden i objavljen od strane proizvođača, brenda TCL, i preuzet je sa njihove zvanične stranice. S obzirom na ovu činjenicu, Tehnoteka ističe da ne preuzima odgovornost za tačnost, celovitost ili pouzdanost informacija, podataka, mišljenja, saveta ili izjava sadržanih u ovom dokumentu.

Napominjemo da Tehnoteka nema ovlašćenje da izvrši bilo kakve izmene ili dopune na ovom dokumentu, stoga nismo odgovorni za eventualne greške, propuste ili netačnosti koje se mogu naći unutar njega. Tehnoteka ne odgovara za štetu nanесenu korisnicima pri upotrebi netačnih podataka. Ukoliko imate dodatna pitanja o proizvodu, ljubazno vas molimo da kontaktirate direktno proizvođača kako biste dobili sve detaljne informacije.

Za najnovije informacije o ceni, dostupnim akcijama i tehničkim karakteristikama proizvoda koji se pominje u ovom dokumentu, molimo posetite našu stranicu klikom na sledeći link:

<https://tehnoteka.rs/p/tcl-qled-televizor-43c735-akcija-cena/>