

## Uputstvo za upotrebu

FOX televizor 32DTV230E



Tehnoteka je online destinacija za upoređivanje cena i karakteristika bele tehnike, potrošačke elektronike i IT uređaja kod trgovinskih lanaca i internet prodavnica u Srbiji. Naša stranica vam omogućava da istražite najnovije informacije, detaljne karakteristike i konkurentne cene proizvoda.

Posetite nas i uživajte u ekskluzivnom iskustvu pametne kupovine klikom na link:

<https://tehnoteka.rs/p/fox-televizor-32dtv230e-akcija-cena/>

# 包装通知单

图纸编号 65-EUZ100-H575

客户名称 福布斯

订单号 2207-0029

客户牌子 FOX

CPU 512-Z1(EU)

送至部门: 彩电工程部 \_\_\_\_\_ 生产计划部 \_\_\_\_\_ 销售中心 \_\_\_\_\_

采购中心 \_\_\_\_\_ 彩电物料部 \_\_\_\_\_ 彩电生产部 \_\_\_\_\_ 质量中心 \_\_\_\_\_

主题: 说明书

说明: A5规格, 英俄合订本。

材质: 封面封底105g铜版纸彩色印刷, 内页70g双胶纸单色印刷。



制图:

美工审核:

美工批准:

结构审核:

电子审核:

DQA审核:



## UPUTSTVO ZA UPOTREBU

### LED TELEVIZORI

Model: 32DTV230E

**HDMI**<sup>™</sup>  
HIGH-DEFINITION MULTIMEDIA INTERFACE

Hvala Vam što ste kupili ovaj uređaj.

FOX LED televizori prepoznaju se po odličnim tehničkim karakteristikama, kao i modernom, funkcionalnom i elegantnom dizajnu. Osim toga konstantna unapređenja u vidu postprodajne

podrške, izuzetno efikasna i rasprostranjena servisna mreža čine da se ponosni vlasnici FOX televizora mogu osećati sigurno.

Napravili ste pravi izbor.



U nastavku slede uputstva za upotrebu. Nisu komplikovana, ali ih se morate pridržavati.

SR

## VAŽNA BEZBEDONOSNA UPUTSTVA

### UPOZORENJE

KAKO BISTE SPREČILI POŽAR ILI ELEKTRIČNI UDAR NEMOJTE KORISTITI PRODUŽNI KABL, DUPLI UTIKAČ ILI DRUGE DODATKE NA UTIČNICI OSIM ONIH KOJI BI MOGLI DA SPREČE IZAZIVANJE STRUJNOG UDARA. KAKO BISTE SPREČILI POŽAR ILI ELEKTRIČNI UDAR NE IZLAŽITE OVAJ UREĐAJ VLAZI ILI KIŠI.

 <p>Ovaj simbol munje u jednakokraničnom trouglu upozorava korisnike na prisustvo opasnog i ne izolovanog napona unutar kućišta proizvoda koji može biti dovoljan da stvori rizik STRUJNOG UDARA</p>	<p><b>CAUTION</b></p> <p>RISK OF ELECTRIC SHOCK DO NOT OPEN</p> <p>Upozorenje: Da biste smanjili rizik od strujnog udara nemojte skidati poklopac (ili zadnju stranu). Unutra nema delova koje korisnik može sam da zameni. Za obavljanje servisa zatražite pomoć kvalifikovanog osoblja.</p>	 <p>Znak uzvika unutar jednakokraničnog trougla u ovom uputstvu upozorava korisnika na prisustvo važnih instrukcija za rad i održavanje (servisiranje) uređaja.</p>
---	---	--

Ovaj aparat ne treba izlagati vodi, a predmete ispunjene tečnošću poput vaza ne treba da budu postavljeni na i oko uređaja.

### OPREZ

Postoji opasnost od eksplozije ako se baterija nepropisno zameni. Zamenite postojeću sa samo odgovarajućom vrstom baterije. Nemojte izlagati bateriju direktnoj sunčevoj svetlosti ili bilo kojem drugom izvoru toplote. Obezbedite pravilno odlaganje istrošenih baterija. Ostavite lako dostupnim mesto gde je utikač ili nastavak za prekid napajanja. Da biste smanjili rizik od strujnog udara, ne obavljajte bilo kakvo servisiranje osim onih koje se pominju u ovom uputstvu.

### VAŽNE INFORMACIJE

Ako televizor nije postavljen na dovoljno stabilnom mestu, može postojati potencijalna opasnost od pada. Mnoge povrede, posebno dečije, mogu se izbeći primenom jednostavnih mera opreza kao što su:  
Korišćenje elemenata ili stalaka koje je preporučio proizvođač televizora.  
Korišćenje samo onog nameštaja koji može sigurno izdržati uređaj.  
Obezbeđivanje uređaja tako da ne prelazi ivicu nameštaja.  
Nemojte postavljati TV na visok nameštaj (na primer, ormare ili police) bez prethodnog pričvršćivanja kako nameštaja tako i uređaja na odgovarajuću površinu.  
Ne pokrivajte televizor krpom i ne stavljajte drugi materijal između televizora i nameštaja na kom on stoji.



#### Sigurna instalacija

Koristite pojas za fiksiranje televizora kako bi sprečili uređaj od pada unapred.



1. **Pročitajte uputstva**- Sve napomene o sigurnosti i načinu rada treba pročitati pre uključivanja aparata.
2. **Sačuvajte uputstva** – Uputstva za sigurnost i uputstvo za upotrebu treba da se sačuvaju za buduće potrebe.
3. **Imajte u vidu Upozorenja** – Treba se pridržavati svih upozorenja na aparatu i svih uputstava za upotrebu.
4. **Pratite uputstva**- Treba pratiti sva uputstva.

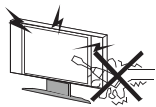

5. **Voda i vlažnost** – Aparat ne treba koristiti u blizini vode.
  6. **Nosač i postolje** – Aparat treba koristiti samo sa nosačem ili postoljem koje preporučuje proizvođač
  7. **Montaža na zid ili plafon** – Aparat treba da se montira na zid ili plafon samo po preporuci proizvođača.
  8. **Ventilacija** – Aparat treba da bude dobro postavljen, tako da lokacija ili pozicija aparata ne ometaju njegovo provetravanje.
  9. **Toplota** – Ovaj aparat treba postaviti dalje od izvora toplote kao što su radijatori i peći.
  10. **Napajanje** - Aparat treba povezati samo na napajanje kao što je opisano u uputstvima za upotrebu ili onako kako je naznačeno na uređaju.
  11. **Uzemljenje ili polarizacija** – Treba preduzeti mere predostrožnosti.
  12. **Zaštita kabla za napajanje** – Naponski kabl treba da bude usmeren tako da je malo verovatno da se može gaziti, priklješiti stvarima na njemu i njegovom kraju.
  13. **Čišćenje** – Aparat bi trebalo čistiti samo po preporuci proizvođača.
  14. Napajanje spoljne antene treba da se nalazi daleko od dalekovoda.
  15. **Uzemljenje spoljne antene** – Ako je spoljna antena povezana na prijemnik, antenski sistem mora biti uzemljen kako bi se obezbedila zaštita od naponskog i izvornog statičkog elektriciteta.
  16. **Kada ga dugo ne koristite** – napajanje uređaja trebalo bi da bude isključeno iz utičnice kada se ne koristi duži vremenski period.
  17. **Upad predmeta i tečnosti** – Treba paziti da predmeti ne upadnu, a tečnost ne prospe u kućište kroz otvore.
  18. **Kada je potreban servis** – Aparat treba da servisira kvalifikovano servisno osoblje kada su:
    - Kabal za struju ili utikač oštećeni.
    - Kada predmeti upadnu ili kada se tečnost prolje po uređaju
    - Kada je aparat izložen kiši
    - Kada aparat ne radi normalno ili pokazuje značajnu promenu u radu.
  19. Ventilacioni otvori ne bi trebalo da budu pokriveni predmetima, kao sto su novine, tkanine, zavese itd.
  20. Izvore otvorenog plamena, kao sto su upaljene sveće, ne bi trebalo da stoje na aparatu
  21. Aparat će biti povezan sa mrežnom utičnicom sa zaštitnim uzemljenjem. Utičnica ili nastavak za prekid napajanja trebaju da budu lako dostupni.
-

**UPOZORENJE**

Visok napon se koristi u napajanju ovog uređaja. Ne uklanjajte zadnji poklopac. Obratite se kvalifikovanoj osobi za obavljanje servisa.

**UPOZORENJE**

Da biste sprečili požar ili strujni udar, nemojte izlagati uređaj kiši ili vlazi.

**UPOZORENJE**

Nemojte ispuštati i gurati predmete u kućište TV-a ili u otvore. Nikada nemojte prosipati tečnost na TV prijemnik.

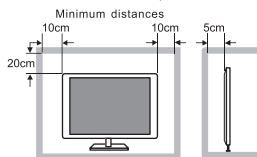
**OPREZ**

Ako televizor treba da se ugradi u zatvoreni odeljak ili na sličan način, morate se pridržavati dela uputstva o minimalnim udaljenostima. Toplota može smanjiti životni vek televizora, a takođe može biti povećan rizik od požara.

**OPREZ**

Nikada nemojte da stanete ili se oslonite ili gurnete uređaj ili stalak na kom se uređaj nalazi. Treba obratiti posebnu pažnju na decu.

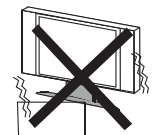
**OPREZ**

Ne stavljajte glavnu jedinicu na nestabilno postolje, policu ili sto. Usled pada može doći do ozbiljne povrede lica ili štete na televizoru.

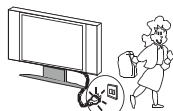
**OPREZ**

Kada se proizvod ne koristi duži vremenski period, preporučljivo je da isključite mrežni kabl iz utičnice .

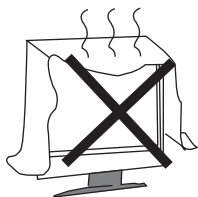
**OPREZ**

Izbegavajte izlaganje glavne jedinice direktnom suncu i drugim izvorima toplote. Ne postavljajte televizor na druge proizvode koji emituju toplotu. Na primer: Video uređaj, audio pojačala. Ne blokiraj otvore za ventilaciju u zadnjem poklopcu. Ventilacija je od suštinskog značaja za sprečavanje električnih kvarova. Ne stavljajte kabl za napajanje ispod glavne jedinice.

**OPREZ**

Panel (ekran) koji se koristi u ovom proizvodu napravljen je od stakla. Može se slomiti padom uređaja ili nasilnim udarcem. Pojedinci treba oprezno da rade sa razbijenim staklom ekrana.



- Postavite TV na stabilnu, ravnu površinu, ostavljajući najmanje 10 cm oko njega i 30 cm između vrha seta i zida ili ormarića. Da biste sprečili da se televizor prevrne kada ga gurnete, postavite ga blizu zida. Umesto da držite gornju stranu televizora kada ga okrećete, trebalo bi da držite donju stranu.

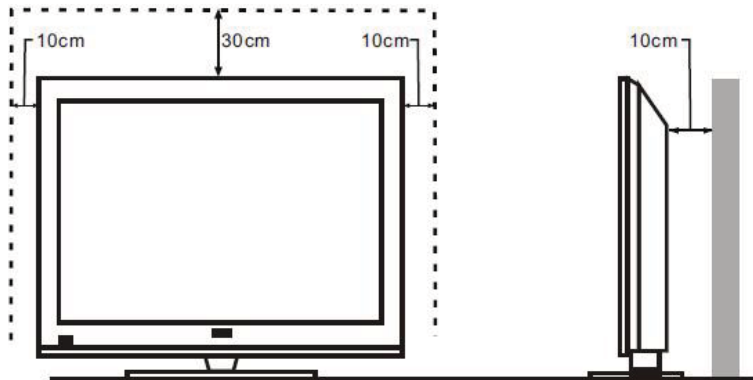

- Izbegavajte rukovanje televizorom samo jednom rukom kada ga podižete; umesto toga, koristite dve ruke.

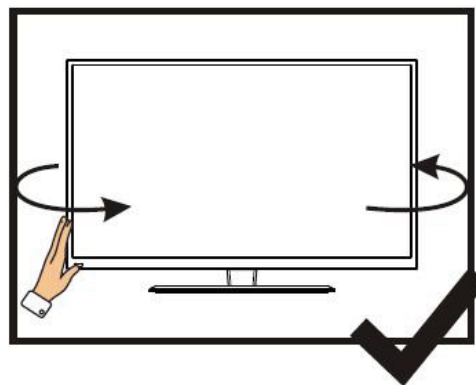
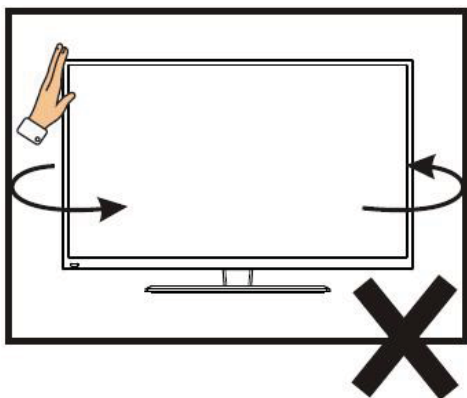

- Izbegavajte rukovanje televizorom samo jednom rukom kada ga podižete; umesto toga, koristite dve ruke.

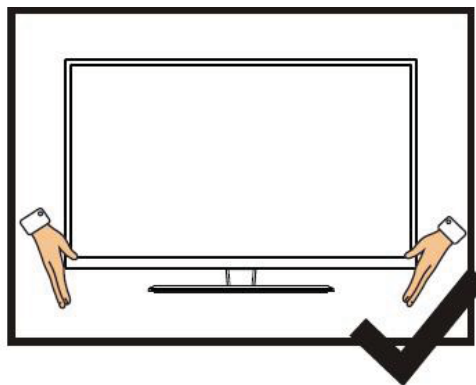
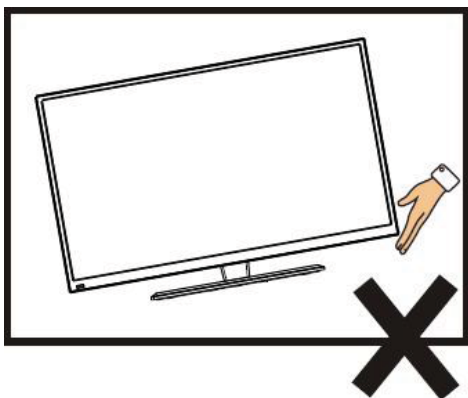

## SADRŽAJ

1. Priključivanje i priprema TV-a .....	2
1.1 Dodatna oprema .....	2
1.2 Instalacija postolja .....	2
1.3 Tasteri i interfejsi .....	3
1.4 Daljinsko upravljanje .....	4
1.5 Instalacija baterija .....	5
2. Osnovna operacija .....	5
2.1 Uključivanje/isključivanje (opciono) .....	5
2.2 Podešavanje režima pripravnosti .....	5
2.3 zbor režima unosa .....	6
2.4 Meni Funkcije .....	6
2.5 Multimedija .....	11
3. Tehnička specifikacija .....	15
4. Podržani režimi signala .....	16
5. Jednostavno otklanjanje poteškoća .....	17



# FOX LED TV

---

## 1 Priključivanje i priprema TV-a

### 1.1 Dodatna oprema

- ✧ Uputstvo za korišćenje
- ✧ Daljinsko upravljanje
- ✧ Baterija (UM-4/R03P/AAA)
- ✧ Komplet za montiranje na zid (unapred montiran) (opciono)

### 1.2 Instalacija postolja

(Molimo pogledajte stvarni objekat za detalje o fizičkoj strukturi.)

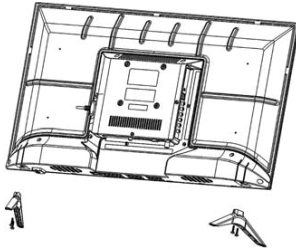

- 1) Postavite TV na mekanu tkaninu ili meke jastuke na sto tako da prednja ploča bude okrenuta nadole.
- 2) Stavite postolje u donju utičnicu televizora.
- 3) Zašrafite utičnice sa zavrtnjima na mestu, a zatim ih zategnite.

# FOX LED TV

## 1.3 Tasteri i interfejsi

Stvarne stavke se koriste kao standard u dizajnu i specifikaciji.

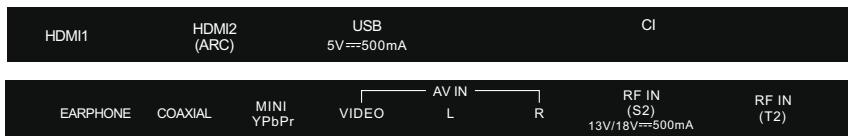
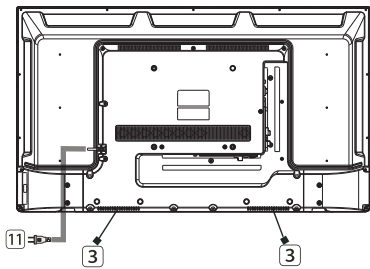
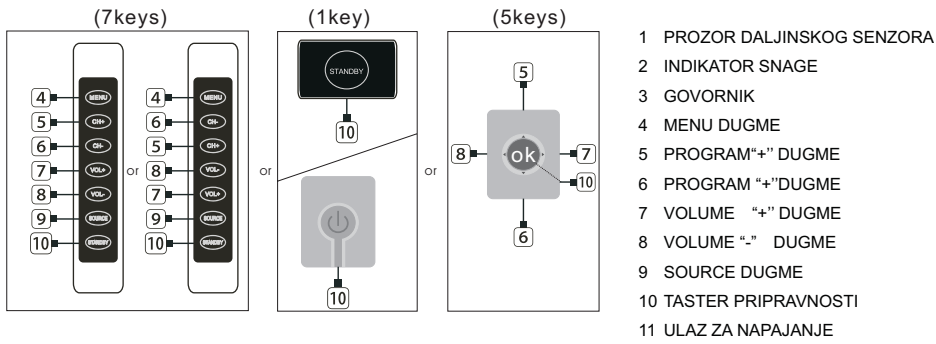
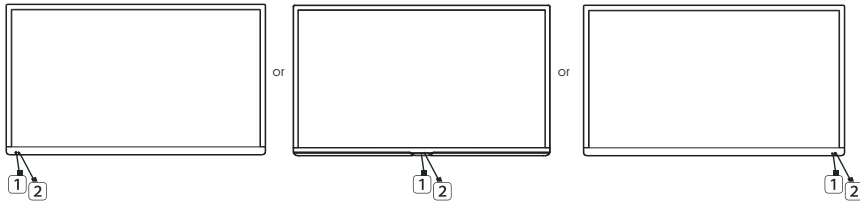

# FOX LED TV

## 1.4 Daljinski upravljač

(Ovde je samo skica, molim vas ljubazno prevladajte)

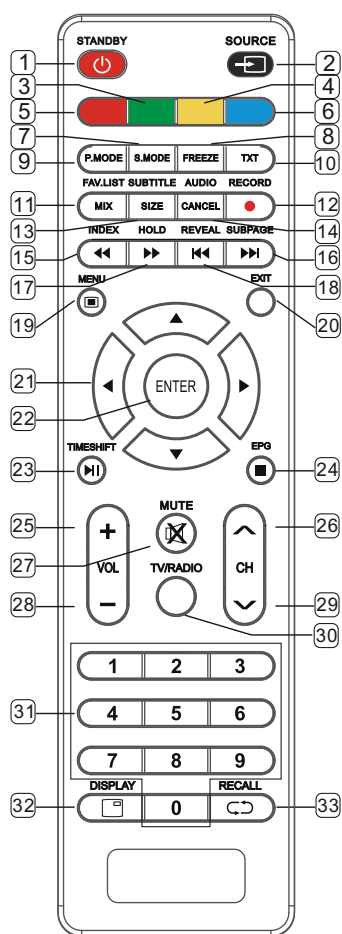

1. STANDBBY ( ): Uključivanje i isključivanje stanja pripravnosti.
2. SOURCE: Izaberite izvor signala.
3. GREEN: Pristupite zelenoj stavci ili stranici.
4. YELLOW: Pristupite žutoj stavci ili stranici.
5. RED: Pristupite crvenoj stavci ili stranici.
6. BLUE: Pristupite plavoj stavci ili stranici.
7. S.MODE: Izaberite režim zvuka.
8. FREEZE: Zamrzni sliku.
9. P.MODE: Izbor režima slike.
10. TXT: Unesite ili izađite iz teleteksta.
11. FAV.LIST: Lista omiljenih kanala.  
Or MIX (under TXT): postavljanje prozirnosti.
12. RECORD: DTV režim zapisuj USB disk sa podacima.
13. SUBTITLE: DTV režim bira režim titla.  
Or SIZE (under TXT): podešavanje veličine karaktera.
14. AUDIO: Izaberite TV audio režim.  
Or SIZE (under TXT): otkažite TXT na ekranu.
15. INDEX: Prikažite indeks stranicu.  
MEDIA mode: Brzo unazad.
16. SUBPAGE: Uđite u režim podstranice.  
MEDIA mode: Sledeći
17. HOLD: Držite trenutnu stranicu.  
MEDIA mode: Brzo unapred.
18. REVEAL: Otkrijte skrivene informacije.  
MEDIA Mode: Prethodna.
19. MENU: Unošenje ili izlazak iz menija.
20. EXIT: Izađite iz menija ili operacije.
21. key: Izbor stavke menija.
22. ENTER: Potvrdite ili unesite.
23. TIMESHIFT: Pomeranje vremena u DTV režimu.  
MEDIA mode: Pritisnite jednom da biste pauzirali, pritisnite ponovo da biste se repromatisali.
24. EPG: Ulazak ili izlaz iz EPG-a (vodič za elektronski program)  
MEDIA mode: Zaustavite reprodukciju i vratite se na listu datoteka.
25. VOL+: Povećajte jačinu zvuka.
26. CH^: Izaberite kanal unapred.
27. MUTE: Utišajte zvuk.
28. VOL-: Smanjite jačinu zvuka.
29. CHv: Izaberite kanal unazad.
30. TV/RADIO: Izaberite TV ili radio režim.
31. 0-9: Ponovo pritisnite dugmad da biste izabrali kanal.
32. DISPLAY: Prikažite informacije o trenutnom videu i zvuku.
33. RECALL: Vratite se na prethodni kanal.

## 1.5 Instalacija baterija

(Molim vas da prevladate, ovo je samo skica.)



- 1 Zadnji poklopac daljinskog upravljača treba da bude otvoren.
- 2 Stavite dve 7# (AAA) 1.5V baterije u sistem.  
Uverite se da su baterije pravilno polarizovane.
- 3 Pokrijte zadnji poklopac.

Izvadite baterije iz daljinskog upravljača ako ga neko vreme nije koristio.

Izvršite sledeće provere ako daljinski upravljač ne funkcioniše ispravno.

- Proverite da li je TV u programu.
- Proverite da li je polaritet baterija odgovarajući.
- Proverite da li baterije nisu iscrpljene.
- Uverite se da je napajanje u ispravnom stanju ili da je kabl za napajanje pravilno povezan.
- Uverite se da u blizini nema neobičnih neonskih ili fluorescentnih svetla.

## 2 Osnovna operacija

### 2.1 Uključivanje/isključivanje (opciono)

- Povežite kabl za napajanje sa **AC ulazni**. Utaknite kabl za napajanje u odgovarajuću utičnicu.
- Pritisnite **Prekidač** da uključite TV, zatim pritisnite **Napajanje** dugme za uključivanje jedinice.
- Pritisnite **Prekidač** ponovo da isključite TV.

Beleška: Nemojte odmah ponovo da otvarate prekidač za napajanje nakon što isključite TV; umesto toga, sačekajte jedan minut pre nego što ponovo otvorite prekidač za napajanje.

### 2.2 Podešavanje režima pripravnosti

- Pritisnite (⏻) dugme da biste uključili jedinicu.
- Pritisnite (⏻) dugme ponovo da vratite ekran u režim pripravnosti. Indikator napajanja svetli crveno.
- Uverite se da vaš TV nije ostavljen u režimu pripravnosti duži vremenski period.

### 2.3 Izbor režima unosa

Ovaj set sadrži više modova izvora signala; pritiskajte dugme **Source** više puta da biste izabrali izvor signala.

# FOX LED TV

---

## 2.3 Izbor režima unosa

Ovaj set sadrži više modova izvora signala; pritisnite dugme **SOURCE** više puta da biste izabrali izvor signala.

## 2.4 Meni Funkcije

Funkcija slike u glavnom meniju biće opisana u ovom poglavlju.

### Meni SLIKA



#### Režim slike

Pritisnite **▲/▼** dugme da biste izabrali Režim slike, zatim pritisnite dugme **ENTER** da biste ušli i pritisnite **▲/▼** dugme da izaberete.

#### Osvetljenje

Pritisnite **▲/▼** dugme da biste izabrali Osvetljenje, zatim pritisnite dugme **ENTER** da biste ušli i pritisnite **◀/▶** dugme za podešavanje. Zatim pritisnite dugme **MENU** da se vratite direktno na prethodni meni.

#### Kontrast

Pritisnite **▲/▼** dugme da biste izabrali Kontrast, zatim pritisnite dugme **ENTER** da biste ušli i pritisnite **◀/▶** dugme za podešavanje. Zatim pritisnite dugme **MENU** da se vratite direktno na prethodni meni.

#### Oštrina

Pritisnite **▲/▼** dugme da biste izabrali Oštrina, zatim pritisnite dugme **ENTER** da biste ušli i pritisnite **◀/▶** dugme za podešavanje. Zatim pritisnite dugme **MENU** da se vratite direktno na prethodni meni.

#### Boja

Pritisnite **▲/▼** dugme da biste izabrali Boja, zatim pritisnite dugme **ENTER** da biste ušli i pritisnite **◀/▶** dugme za podešavanje. Zatim pritisnite dugme **MENU** da se vratite direktno na prethodni meni.

#### Nijansa

Pritisnite **▲/▼** dugme da biste izabrali Nijansa, zatim pritisnite dugme **ENTER** da biste ušli i pritisnite **◀/▶** dugme za podešavanje. Zatim pritisnite dugme **MENU** da se vratite direktno na prethodni meni.

#### Temperatura boje

Pritisnite **▲/▼** dugme da biste izabrali **Temperatura boj**, zatim pritisnite dugme **ENTER** da biste ušli i pritisnite **◀/▶** dugme da izaberete.

#### Proporcija širine i visine

Pritisnite **▲/▼** dugme da biste izabrali **Proporcija širine i visine**, zatim pritisnite dugme **ENTER** da biste ušli i pritisnite **◀/▶** dugme da izaberete.

#### Smanjenje buke

Pritisnite **▲/▼** dugme da biste izabrali **Smanjenje buke**, zatim pritisnite dugme **ENTER** da biste ušli i pritisnite **◀/▶** dugme da izaberete.

## Meni Zvuka



### Režim zvuka

Pritisnite **▲/▼** dugme da biste izabrali **Režim zvuka**, zatim pritisnite dugme **ENTER** da biste ušli. I onda pritisnite **◀/▶** dugme da izaberete.

### Bas

Pritisnite **▲/▼** dugme da biste izabrali Bas, zatim pritisnite dugme **ENTER** ili **▶** da biste ušli i pritisnite **◀/▶** dugme za podešavanje. Podešava se samo u korisničkom režimu. Zatim pritisnite dugme **MENU** da se vratite direktno na prethodni meni.

### Visoki tonovi

Pritisnite **▲/▼** dugme da biste izabrali **Visoki tonovi**, zatim pritisnite dugme **ENTER** da biste ušli i pritisnite **◀/▶** dugme za podešavanje. Podešava se samo u korisničkom režimu. Zatim pritisnite dugme **MENU** da se vratite direktno na prethodni meni.

### Balans

Pritisnite **▲/▼** dugme da biste izabrali Balans, zatim pritisnite dugme **ENTER** da biste ušli i pritisnite **◀/▶** dugme za podešavanje. Zatim pritisnite dugme **MENU** da se vratite direktno na prethodni meni.

### Okružiti

Pritisnite **▲/▼** dugme da biste izabrali **Okružiti**, zatim pritisnite dugme **ENTER** da biste ušli i pritisnite **◀/▶** dugme da izaberete **UKLJUČENO** ili **ISKLJUČENO**.

### AVL

Pritisnite **▲/▼** dugme da biste izabrali **AVL**, zatim pritisnite dugme **ENTER** da biste ušli i pritisnite **◀/▶** dugme za podešavanje.

### SPDIF

Pritisnite **▲/▼** dugme da biste izabrali **SPDIF**, zatim pritisnite dugme **ENTER** da biste ušli i pritisnite **◀/▶** dugme da izaberete.

### Audio opis

Pritisnite **▲/▼** dugme da biste izabrali **Audio opis**, zatim pritisnite dugme **ENTER** da biste ušli i pritisnite **▶** dugme da biste ušli u podmeni.

# FOX LED TV

---

## Meni kanala



### Upravljanje kanalima

Pritisnite ▲/▼ dugme da biste izabrali **Upravljanje kanalima**, zatim pritisnite dugme **ENTER** da biste preimenovali kanal koji ste izabrali.

### Omiljeno upravljanje

Pritisnite ▲/▼ dugme da biste izabrali **Omiljeno upravljanje**, zatim pritisnite dugme **ENTER** do menija za upravljanje omiljenim.

### TV veza

Pritisnite ▲/▼ dugme da biste izabrali **TV veza**, zatim pritisnite dugme **ENTER** da izaberete tip povezivanja na TV koji koristite.

### Automatsko podešavanje

Pritisnite ▲/▼ dugme da biste izabrali **Automatsko podešavanje**, zatim pritisnite dugme **ENTER** da biste ušli.

### DTV Ručna Pretraga

Pritisnite ▲/▼ dugme da biste izabrali **DTV Ručna Pretraga**, zatim pritisnite dugme **ENTER** da započnete skeniranje.

### ATV Ručna Pretraga

Pritisnite ▲/▼ dugme da biste izabrali **ATV Ručna Pretraga**, zatim pritisnite dugme **ENTER** da započnete skeniranje ATV kanala.

### LCN Uključen/Isključen

Pritisnite ▲/▼ dugme da biste izabrali **LCN Uključen/Isključen**, zatim pritisnite dugme **ENTER** da biste uključili ili isključili LCN.

## Meni odlika



### Zaključati

Da biste otvorili podmeni sa lozinkom "0000", pritisnite dugme ▲/▼ da biste izabrali **Lock**, i zatim pritisnite dugme **ENTER**.

### Jezik

Pritisnite ▲/▼ dugme da biste izabrali **Jezik**, zatim pritisnite dugme **ENTER** ili ► da biste ušli u podmeni. Zatim pritisnite ▲/▼ dugme da biste izabrali, zatim pritisnite **ENTER** ili ► dugme da biste potvrdili.

### Spavaj Tajmer

Pritisnite ▲/▼ dugme da biste izabrali **Spavaj Tajmer**, zatim pritisnite dugme **ENTER** da biste ušli i pritisnite ▲/▼ dugme da izaberete.

### Automatsko isključivanje

Pritisnite ▲/▼ dugme da biste izabrali **Automatsko isključivanje**, zatim pritisnite dugme **ENTER** da biste ušli u podmeni.

Zatim pritisnite ▲/▼ da biste izabrali isključeno, 1 sat ,2 sata, 4 sata, a zatim pritisnite **ENTER** da biste potvrdili. (Kada je priključen PC signal).

### Oslabljen sluh

Pritisnite ▲/▼ dugme da biste izabrali **Oslabljen sluh**, zatim pritisnite dugme **ENTER** da biste ušli i pritisnite ▲/▼ da biste izabrali isključeno ili uključeno.

### CI informacije

Pritisnite ▲/▼ dugme da biste izabrali **CI informacije**, zatim pritisnite dugme **ENTER** da biste prikazali informacije o CI slotu.

### PVR/Vremenski Pomeraj

Pritisnite ▲/▼ dugme da biste izabrali **PVR/Vremenski Pomeraj**, zatim pritisnite dugme **ENTER** da biste otvorili podmeni.



## Meni za podešavanje



### OSD Tajmer

Pritisnite ▲/▼ dugme da biste izabrali **OSD Tajmer**, zatim pritisnite dugme **ENTER** ili ► da izaberete.

### Plavi ekran

Pritisnite ▲/▼ dugme da biste izabrali **Plavi ekran**, zatim pritisnite dugme **ENTER** ili ► da izaberete uključeno ili isključeno.

### Kućni Režim

Pritisnite ▲/▼ dugme da biste izabrali **Kućni Režim**, i zatim pritisnite ◀/▶ dugme da izaberete Početna ili Prodavnica, zatim pritisnite dugme **ENTER** da biste potvrdili.

### Resetujte TV podešavanja

Pritisnite ▲/▼ dugme da biste izabrali **Resetujte TV podešavanja**, i zatim pritisnite **ENTER** da biste ušli u podmeni, i unesite lozinku ako je uređaj zaključan pre nego što brzo prilagodite podrazumevana podešavanja televizora.

### Verzija

Pritisnite ▲/▼ dugme da biste izabrali **Verzija**, i zatim pritisnite **ENTER** da biste ušli u podmeni, nakon toga možete pogledati verziju softvera televizora.

## 2.5 Multimedija

### 1. Foto

#### 1.1 Uvod u funkciju

Pritisnite dugme "DESNO" / "LEVO" da biste izabrali stavku "FOTO" u glavnom meniju multimedije, i zatim pritisnite "ENTER".



Operacija sa ključem









- 1) RED: Izbrišite fokusiranu fasciklu/datoteku.
- 2) GREEN: Dodaj/izbriši sve datoteke sa fotografijama na listu za reprodukciju.
- 3) ENTER: Dodaj/izbriši istaknute datoteke na listu za reprodukciju.
- 4) CH+/-: Stranica gore/Stranica dole.
- 5) PLAY: Pustite datoteke na listi za reprodukciju.

#### 1.1.1 Ponovite Pusti

Da biste započeli ponavljanje pusti, pritisnite dugme "PLAY".



Operacija sa ključem

- 1)  Da biste započeli reprodukciju fotografija u režimu projekcije slajdova, isto da pritisnete dugme "PLAY" na daljinskom upravljaču.
- 2)  Da biste pauzirali video datoteku, isto da pritisnete dugme "PAUZA" na daljinskom upravljaču.
- 3)  Da biste zaustavili slajd prezentaciju i vratili se u pretraživač datoteka, isto da pritisnete dugme "ZAUSTAVITI" na daljinskom upravljaču.
- 4)  Da biste direktno reprodukovali prethodnu ili sledeću datoteku, isto da pritisnete dugme "|<<" / ">>|" na daljinskom upravljaču.
- 5)  Da biste rotirali igranje slike (0 °, 90 °, 180 °, 270°).
- 6)  Da biste zumiranje igranje slike.
- 7)  Za prikaz informacija o trenutnoj datoteci, isto da pritisnete dugme "INFO" na daljinskom upravljaču.
- 8)  Da biste ušli u meni "Podešavanje fotografije", uključujući "Režim ponavljanja", "Muzika u pozadini", "Izvor muzike", "Vreme slajdova", "Efekat".
- 9)  Da biste ušli u meni liste reprodukcije.

## 2. Muzika

### 2.1 Uvod u funkciju

Pritisnite dugme "DESNO" / "LEVO" da biste izabrali stavku "MUZIKA" u glavnom meniju multimedije, i zatim pritisnite dugme "ENTER" da biste pristupili muzičkoj stranici, kao što je prikazano:



Operacija sa ključem









- 1) RED: Izbrišite fokusiranu fasciklu/datoteku.
- 2) GREEN: Dodaj/izbriši sve datoteke sa muzika na listu za reprodukciju.
- 3) ENTER: Dodaj/izbriši istaknute datoteke na listu za reprodukciju.
- 4) CH+/-: Stranica gore/Stranica dole.
- 5) PLAY: Pustite datoteke na listi za reprodukciju.

#### 2.1.1 Ponovite Pusti

Da biste započeli ponavljanje pusti, pritisnite dugme "PLAY".



Operacija sa ključem

- 1)  Da biste započeli reprodukciju datoteke ili nastavili pauziranu datoteku, isto da pritisnete dugme "PLAY" na daljinskom upravljaču.
- 2)  Da biste pauzirali video datoteku, isto da pritisnete dugme "PAUZA" na daljinskom upravljaču.
- 3)  Da biste zaustavili reprodukciju datoteke, isto da pritisnete dugme "ZAUSTAVITI" na daljinskom upravljaču.
- 4)  Da biste brzo reprodukovali unazad ili unapred, isto da pritisnete dugme "|<<" / ">>|" na daljinskom upravljaču. Brzina se može promeniti na dva puta, četiri puta, osam puta i šesnaest puta, a na ekranu se prikazuje kao "X2, X4, X8, X16".
- 5)  Da biste direktno reprodukovali prethodnu ili sledeću datoteku, isto da pritisnete dugme "|<<" / ">>|" na daljinskom upravljaču..
- 6)  Da biste promenili režim ponavljanja, uključujući režime "Ponovi 1", "Ponovi sve", "Ponovi Dir" i "Nasumično".
- 7)  Da biste promenili prozor između "Informacije" i "Lista za reprodukciju".
- 8)  Za zatvaranje panela samo u režimu "MUZIKA", a zatim se svako dugme na daljinskom upravljaču može koristiti da se otvori, isto tako da se pritisne "BLUE" dugme na daljinskom upravljaču.

# FOX LED TV

## 3. Film

Pritisnite dugme "DESNO" / "LEVO" da biste izabrali stavku "FILM" u glavnom meniju multimedije, i zatim pritisnite dugme "ENTER" da biste pristupili film stranici, kao što je prikazano:



Operacija sa ključem

- 1) RED: Izbrišite fokusiranu fasciklu/datoteku.
- 2) GREEN: Dodaj/izbriši sve datoteke sa film na listu za reprodukciju.
- 3) ENTER: Dodaj/izbriši istaknute datoteke na listu za reprodukciju.
- 4) CH+/-: Stranica gore/Stranica dole.
- 5) PLAY: Pustite datoteke na listi za reprodukciju.

### 3.1 Ponovite Pusti

Da biste započeli ponavljanje pusti, pritisnite dugme "PLAY".



Operacija sa ključem

- 1) Da biste započeli reprodukciju datoteke ili nastavili pauziranu datoteku, isto da pritisnete dugme "PLAY" na daljinskom upravljaču.
- 2) Da biste pauzirali video datoteku, isto da pritisnete dugme "PAUZA" na daljinskom upravljaču.
- 3) Da biste zaustavili reprodukciju datoteke i vratili se na interfejs pretraživača datoteka, isto da pritisnete dugme "ZAUSTAVITI" na daljinskom upravljaču.
- 4) Da biste brzo reprodukovali unazad ili unapred, isto da pritisnete dugme "|<<" / ">>|" na daljinskom upravljaču. Brzina se može promeniti na dva puta, četiri puta, osam puta i šesnaest puta, a na ekranu se prikazuje kao "X2, X4, X8, X16".
- 5) Da biste direktno reprodukovali prethodnu ili sledeću datoteku, isto da pritisnete dugme "|<<<" / ">>>|" na daljinskom upravljaču..
- 7) Da biste ušli u spori režim. Brzina se može promeniti na 1/2, 1/4, 1/8, 1/16, a na ekranu se prikazuje kao "X1/2, X1/4, X1/8, X1/16".
- 7) Da biste ušli u korak režim.
- 8) Prvi pritisak postavlja tačku A, drugi pritisak postavlja tačku B, a zatim reprodukujte uzastopno između A i B da biste podesili AB ponavljanje.
- 9) Da biste ušli u meni liste reprodukcije.
- 10) Za prikaz informacija o trenutnoj datoteci, isto da pritisnete dugme "INFO" na daljinskom upravljaču.
- 11) Da biste ušli u meni "Podešavanje filma", uključujući "Programi", "Podnaslov", "Audio", "Režim ponavljanja".
- 12) Korisnik može direktno da unese vreme u koje želi da počne da bi ušao u funkciju "GO TO".

## 4. e-Knjiga

### 4.1 Podržani format

Podržana je samo e-knjiga u formatu txt.

### 4.2 Uvod u funkciju

Pritisnite dugme "DESNO" / "LEVO" da biste izabrali stavku "e-Knjiga" u glavnom meniju multimedije, i zatim pritisnite dugme "ENTER" da biste pristupili e-knjiga stranici, kao što je prikazano:



Operacija sa ključem

- 1) RED: Izbrišite fokusiranu fasciklu/datoteku.
- 2) GREEN: Dodaj/izbriši sve datoteke sa tekst na listu za reprodukciju.
- 3) ENTER: Dodaj/izbriši istaknute datoteke na listu za reprodukciju.
- 4) CH+/-: Stranica gore/Stranica dole.
- 5) PLAY: Pustite datoteke na listi za reprodukciju.

#### 4.2.1 Ponovite Pusti

Da biste započeli ponavljanje pusti, pritisnite dugme "PLAY".

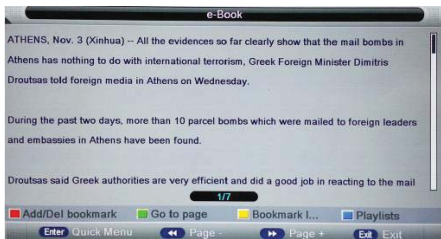

Operacija sa ključem

"RED"	Da biste dodali/izbrisali obeleživač.
"GREEN"	Da direktno unesete broj stranice.
"YELLOW"	Da biste ušli na stranicu "Bookmark list".
"BLUE"	Da biste ušli na stranicu "Play list".
"<<" / ">>"	Da biste uradili stranicu nadole/nagore.
"EXIT"	Da biste zatvorili datoteku i vratili se u pretraživač datoteka.

## 3. Tehnička specifikacija

Model proizvoda	32DTV230E	
Veličina ekrana	32" dijagonala	
Proporcija širine i visine	16:9	
Napajanje	AC 100-240V~,50/60Hz	
Potrošnja struje	60W	
TV sistem	PAL B/G D/K I,SECAM B/G D/K DVB-T/T2/C/S/S2 (opcija s/s2) (DVB-C signal je odsutan u nekim zemljama ili regionima.)	
Audio izlazna snaga (interna)	8Wx2	
Ulazni terminal	Antenski ulaz	x 2 (S2 opcija)
	USB ulazni	x 1
	HDMI ulazni	x 2
	VGA ulazni	NE
	PC AUDIO ulazni	NE
	Audio ulazni ( L/R)	x 1
	Video ulazni	x 1
	YPbPr ulazni	x 1(mini)
	RJ45 ulazni	NE
	Ulazni CI kartice	x 1
	SCART ulazni/izlazni	NE
	DC ulazni (12V)	NE
Izlazni terminal	Slušalica	x 1
	Audio linijski izlazni (L/R)	NE
	Video izlazni	NE
	Optički	NE
	Koaksijalni izlazni	x 1
Radna temperatura	0°C~40°C	
Radna vlažnost	20% ~ 80% Bez kondenzacije	

*Beleška: Gore navedene karakteristike su podložne promeni bez upozorenja u cilju poboljšanja kvaliteta*

## 4. Podržani režimi signala

### A. PbPr Režim

Rezolucija	Horizontalna frekvencija (Khz)	Vertikalna frekvencija (Hz)
480i	15.734	59.94
480p(720x480)	31.468	59.94
576i	15.625	50.00
576p(720x576)	31.25	50.00
720p(1280x720)	37.50	50.00
	45.00	60.00
1080i	28.13	50.00
	33.75	60.00
1080P(1920x1080)	67.50	60.00
	56.25	50.00

### B. HDMI režim

Rezolucija	Horizontalna frekvencija (Khz)	Vertikalna frekvencija (Hz)
480p	31.468	59.94
576p	31.25	50.00
720P	45.00	60.00
1080i	33.75	60.00
1080P(1920x1080)	67.50	60.00

- Poruka upozorenja će se pojaviti na ekranu ako je signal koji ekran prima izvan dozvoljenog opsega.

-Na ekranu možete proveriti format ulaznog signala.

## 5 Jednostavno otklanjanje poteškoća

Ako ekran pokvari ili se njegove performanse drastično promene, proverite ekran u skladu sa smernicama u nastavku. Ne zaboravite da pregledate periferne uređaje kako biste identifikovali koren problema.

Simptom	Rešenje
Napajanje se ne može aktivirati. (Indikator napajanja ne svetli.)	-Potvrdite da su oba kraja kabla za napajanje pravilno umetnuta u utičnicu i da li je zidna utičnica funkcionalna.
Prikazuje se poruka Nema ulaznog signala.	- Proverite da li je signalna linija ispravno povezana. -Potvrdite da su relevantni periferni uređaji uključeni. -Uverite se da izabrani izbor ulaza odgovara ulaznom signalu.
Daljinski upravljač ne radi ispravno.	-Proverite da baterije nisu istrošene. (Koristite novu bateriju.) -Potvrdite da daljinski upravljač radi u svom dometu. - Uverite se da je daljinski upravljač usmeren ka prozoru daljinskog upravljača ekrana. - Uverite se da nema prepreka između daljinskog upravljača i njegovog prozora.
Na ekranu se nalaze trepćuće tačke ili pruge.	- Uverite se da nema emisija (auto, VN žice ili neonske sijalice) ili drugih potencijalnih izvora smetnji.
Boja ili kvalitet slike se pogoršavaju.	- Proverite da li su sva video podešavanja, kao što su osvetljenost, kontrast i boja, pravilno podešena. -Za dodatne informacije o video postavkama, pogledajte OSD funkcije poglavlja 2.
Položaj i veličina ekrana su netačni.	-Potvrdite da su pozicija i veličina ekrana na odgovarajući način.
Slika ili boja su netačne.	- Proverite da li je signalna linija ispravno povezana. -Kada ste povezani sa računarom, možete da promenite rezoluciju računara da biste dobili odgovarajuću sliku. Disparitet u izlaznom signalu računara može uticati na prikaz slike.
Prikažite poruku upozorenja.	- Proverite da li je ulazna linija signala na odgovarajući način obezbeđena. -Izaberite odgovarajući ulazni signal. -Pogledajte Podržani režimi signala u poglavlju 4 za dodatne





# USER MANUAL

## LED Television Model: 32DTV230E

Thank you for purchasing this device.

FOX LED televisions are known for their great performance, as for modern, functional and elegant design. Besides that, we constantly improve our customer support, we have highly efficient and wide network of services, that make our proud customers feel safe.

You made a right choice.

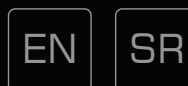

Now it's time for instructions, they are not complicated, but you have to follow them.



## IMPORTANT SAFETY INSTRUCTIONS

### WARNING

- TO PREVENT FIRE OR SHOCK HAZARD, DO NOT USE AN EXTENSION CORD, RECEPTACLE OR OTHER OUTLET UNLESS THE BLADES CAN BE TO PREVENT BLADE EXPOSURE.
- TO PREVENT FIRE OR SHOCK HAZARD, DO NOT EXPOSE THIS APPLIANCE TO RAIN OR MOISTURE.

 <p>This lightning flash with arrowhead symbol in an equilateral triangle alerts users to the presence of uninsulated dangerous voltage within the products enclosure that may be of sufficient magnitude to constitute a risk of electric shock.</p>	<p><b>CAUTION</b></p> <p><b>RISK OF ELECTRIC SHOCK</b> <b>DO NOT OPEN</b></p> <p>Warning: To reduce the risk of electric shock, do not remove cover (or back). No user serviceable parts inside. Refer servicing to qualified service personnel.</p>	 <p>The exclamation mark within an equilateral triangle alerts users to the presence of important operating and maintenance (servicing) instructions in the literature accompanying the appliance.</p>
--	--	---

This appliance should not be exposed to water and no object filled with liquid such as a vase should be placed on the unit.

### CAUTION

- Danger of explosion if batteries are incorrectly replaced.
- Replace with only equivalent type of battery.
- Do not expose battery to direct sunlight or any other source of heat.
- Ensure proper disposal of used batteries.
- Where the MAINS plug or an appliance coupler is used as the disconnect device, the disconnect device shall remain readily operable.
- To reduce the risk of electric shock, do not perform any servicing other than what is mentioned in the operating manual.
- There are no user-serviceable parts inside the TV; do not open the TV casing.

### IMPORTANT INFORMATION

If a television is not positioned in a sufficiently stable location, it can be potentially hazardous due to falling. Many injuries, particularly to children, can be avoided by taking simple precautions such as:

- Using cabinets or stands recommended by the manufacturer of the television.
- Only using furniture that can safely support the television.
- Ensuring the television is not overhanging the edge of the supporting furniture.
- Not placing the television on tall furniture (for example, cupboards or bookcases) without anchoring both the furniture and the television to a suitable support.
- Not standing the televisions on cloth or other materials placed between the television and supporting furniture.
- Educating children about the dangers of climbing on furniture to reach the television or its controls.



#### Safe installation

Use the belt fixing the television to facilitate restraining the television from toping forward.



1. **Read Instructions** - All the safety and operating instructions should be read before the appliance is operated.
2. **Retain Instructions** - The safety and operating instructions should be retained for future reference.
3. **Heed Warnings** - All warnings on the appliance and in the operating instructions should be adhered to.
4. **Follow Instructions** - All operating instructions should be followed.



5. **Water and Moisture** - The appliance should not be used near water.
  6. **Cart and Stands** - The appliance should only be used with a cart or stand that is recommended by the manufacturer.
  7. **Wall or Ceiling Mounting** - The appliance should be mounted to a wall or ceiling only as recommended by the manufacturer.
  8. **Ventilation** - The appliance should be well situated so that its location or position does not interfere with its proper ventilation.
  9. **Heat** - This appliance should be placed away from heat sources such as radiators, heat registers and stoves.
  10. **Power Sources** - The appliance should only be connected to a power supply as described in the operating instructions or as marked on the appliance.
  11. **Grounding or Polarization** - Precautions should be taken.
  12. **Power Cord Protection** - Power supply cord should be routed so that it is not likely to be walked on, pinched by items placed upon it against the cord and its end.
  13. **Cleaning** - The appliance should be cleaned only as recommended by the manufacturer.
  14. **Power Line** - An outdoor antenna should be located away from power lines.
  15. **Outdoor Antenna Grounding** - If an outside antenna is connected to the receiver, the antenna system must be grounded so as to provide against voltages and built-up static charges.
  16. **Non-use Periods** - The power cord of the appliance should be unplugged from the outlet when left unused for a long period of time.
  17. **Object and Liquid Entry** - Care should be taken so that objects did not fall, and liquids are not spilled into the enclosure through openings.
  18. **Conditions requiring Service** - The appliance should be serviced by qualified service personnel when:
    - The power-supply cord or the plug has been damaged.
    - Objects have fallen on or liquid has been spilled into the appliance.
    - The appliance has been exposed to rain.
    - The appliance does not appear to operate normally or exhibits a marked change in performance.
  19. The ventilation should not be impeded by covering the ventilation opening with items, such as newspapers, table-cloths, curtains, etc.  
No naked flame sources, such as lighted candles, should be placed on the apparatus.  
The apparatus shall be connected to mains socket outlet with a protective earthing connection.  
The appliance coupler regard as disconnection device, the disconnect device shall remain readily operable.
-

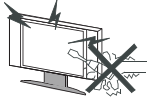

**Warning**

High voltages are used in the operating of this product. Do not remove the back cover of the cabinet. Refer servicing to qualified service personnel.

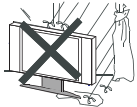

**Warning**

To prevent fire or electrical shock hazard, do not expose the main unit to rain or moisture.



**Warning**

Do not drop or push objects into television cabinet slots or openings. Never spill any kind of liquid on the television receiver.

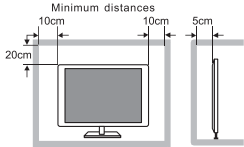

**Caution**

If the television is to be built into a compartment or similarly enclosed, the minimum distances must be maintained. Heat built up can reduce the service life of your television, and can also be dangerous.



**Caution**

Never stand on, lean on, push suddenly the product or its stand. You should pay special attention to children.

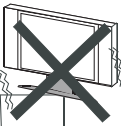

**Caution**

Do not place the main unit on an unstable cart stand, shelf or table. Serious injury to an individual, and damage to the television, may result should it fall.



**Caution**

When the product is not used for an extended period of time, it is advisable to disconnect the AC power cord from the AC outlet.

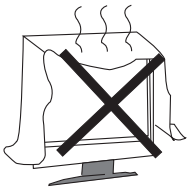

**Caution**

Avoid exposing the main unit to direct sunlight and other sources of heat. Do not position television receiver directly on other products which give off heat. E.g. Video cassette players, audio amplifiers. Do not block the ventilation holes in the back cover. Ventilation is essential to prevent electrical failure. Do not squash power supply cord under the main unit.



**Caution**

The panel used in this product is made of glass. It can break when the product is dropped or applied with force. Individuals should execute caution when dealing with broken glass should the panel break.



- Place the TV on a firm and flat surface, leaving a space of at least 10cm around the set and 30cm from the top of the set to the wall or cabinet. Ensure the TV is positioned close to the wall to avoid it falling when pushed.

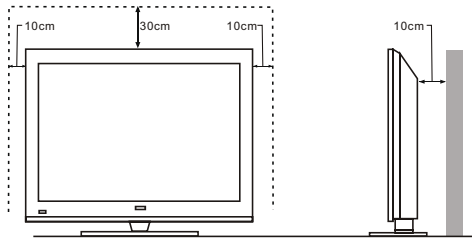

- When you turning the TV set, do not hold the top side of the TV set, you should hold the bottom side.

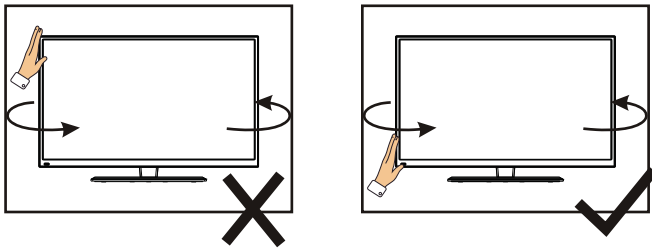

- When you lifting the TV set, do not use one hand to handle it, you should lift the TV set by two hands.

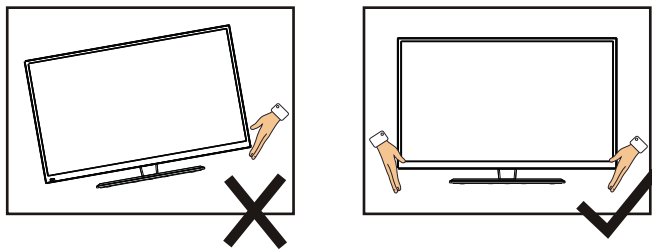

---

# CONTENTS

1. Connection and Preparation of TV.....	2
1.1 Accessories .....	2
1.2 Installation of Stand.....	2
1.3 Keys and Interfaces.....	3
1.4 Remote Control.....	4
1.5 Installation of Batteries.....	5
2. Basic Operation.....	5
2.1 Power ON/OFF(Optional).....	5
2.2 Setting of Standby Mode.....	5
2.3 Selection of Input Mode.....	6
2.4 Menu Functions.....	6
2.5 Multimedia .....	11
3. Technical Specification.....	15
4. Supported Signal Modes.....	16
5. Simple Troubleshooting .....	17

---

# 1. Connection and Preparation of TV

## 1.1 Accessories

- \* User Manual
- \* Remote Control
- \* Battery(UM-4/R03P/AAA)
- \* Wall Mount Kit (Pre-assembled)(Optional)

## 1.2 Installation of Stand

(For the physical structure, please refer to the real object)

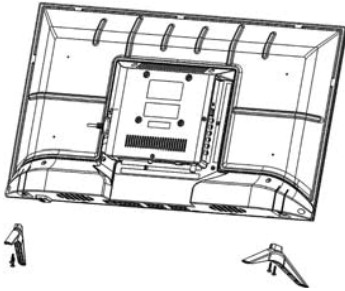

- ① Place the TV with the front panel facing downwards on the soft cloth or soft pads on a desk.
- ② Insert the stand into the bottom socket of the TV.
- ③ Insert the screws into the sockets and tighten them.

### 1.3 Keys and Interfaces

The design and specification takes actual products as the standard

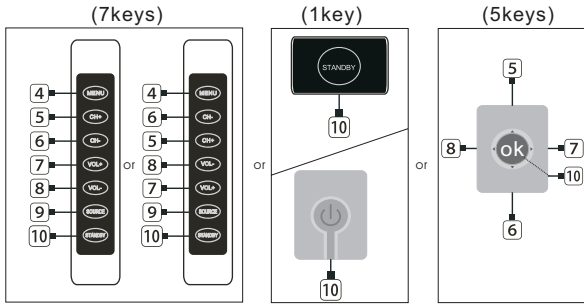
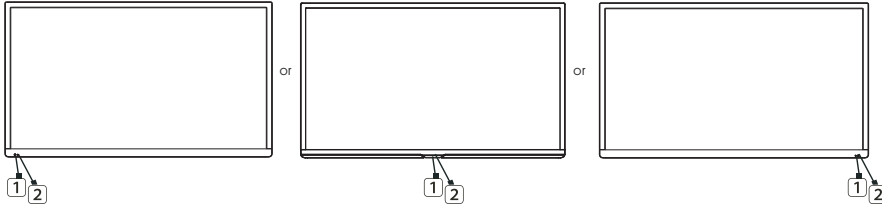

- 1. REMOTE SENSOR WINDOW
- 2. POWER INDICATOR
- 3. SPEAKER
- 4. MENU KEY
- 5. PROGRAM “+” KEY
- 6. PROGRAM “-” KEY
- 7. VOLUME “+” KEY
- 8. VOLUME “-” KEY
- 9. SOURCE KEY
- 10. STANDBYKEY
- 11. POWERPLUG INPUT

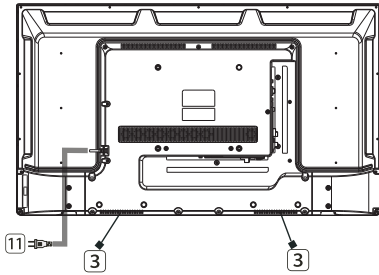

HDMI1	HDMI2 (ARC)	USB 5V==500mA	CI
EARPHONE	COAXIAL	MINI YPbPr	VIDEO
			AV IN L R
			RF IN (S2) 13V/18V==500mA
			RF IN (T2)



## 1.4 Remote Control

(Here is only the sketch, please in kind prevail)

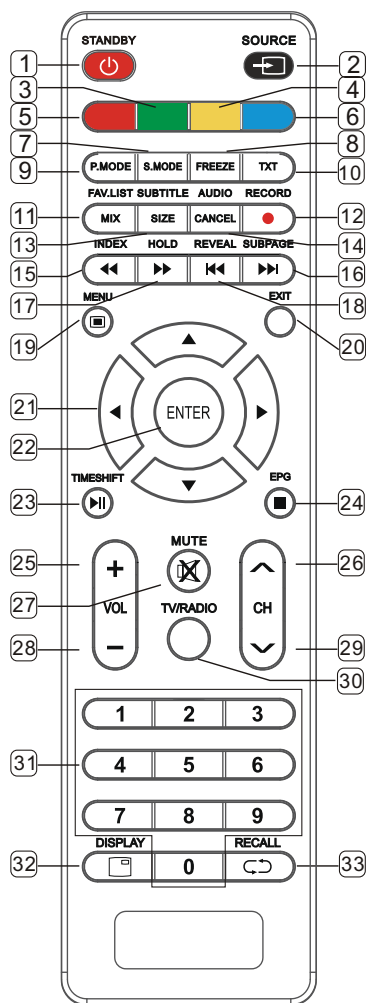

1. STANDBY(⏻) : Standby turn on and off.
2. SOURCE(📺) : Select the signal source.
3. GREEN: Access the green item or page.
4. YELLOW: Access the yellow item or page.
5. RED: Access the red item or page.
6. BLUE: Access the blue item or page.
7. S.MODE: Select the sound mode.
8. FREEZE : Freeze the picture.
- 9 P.MODE: Select the picture Mode.
10. TXT: Enter or exit teletext.
11. FAV.LIST: Favorite channel list.  
Or MIX (under TXT): setting transparency.
12. RECORD: DTV mode record data USB disk.
13. SUBTITLE: DTV mode select subtitle mode.  
Or SIZE (under TXT): setting sizes of the character.
14. AUDIO: Select TV audio mode.  
Or CANCEL (under TXT): cancel the TXT on screen.
15. INDEX: Display the index page.  
MEDIA mode: ◀◀ Fast Backward
16. SUBPAGE: Enter the sub page mode.  
MEDIA mode: ▶▶ Next
17. HOLD: Hold the current page.  
MEDIA mode: ▶▶ Fast Forward
18. REVEAL: Reveal the hidden information.  
MEDIA Mode: ◀◀ Previous.
19. MENU : Enter or exit menu.
20. EXIT : Exit menu or operation.
21. ▲, ▼, ◀, ▶ key: The menu item selection.
22. ENTER: Confirm or enter.
23. TIMESHIFT: DTV mode time shift.  
MEDIA mode: ▶▶ Press one time to pause, press again to playback.
24. EPG: Enter or exit EPG(Electronic Program .Guide)  
MEDIA mode: ■ Stop the playback and return to file list.
25. VOL+: Increase the volume.
26. CH^: Select the channel forward.
27. MUTE: Mute sound.
28. VOL-: Decrease the volume.
29. CHv : Select the channel backward.
30. TV/RADIO: Select the TV or Radio mode.
31. 0~9 : Continue to press the keys to select a channel.
32. DISPLAY : Display the information of current video and audio.
33. RECALL: Return to previous channel.

---

## 1.5 Installation of Batteries

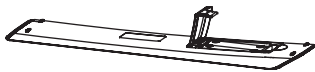

1. Open the back lid of the remote control.

2. Install two 7#(AAA)1.5V batteries.  
Ensure the correct polarity of the batteries.

3. Cover the back lid.

Please take out of the batteries from the remote control for long time of no use.



If the remote control doesn't work properly,

please carry out the following checks.

- Check the TV is turned on.
- Check the polarity of the batteries are correct.
- Check the batteries are not drained.
- Check the power supply is normal or the power cord is correctly connected.
- Check there are no special fluorescent light or neon light around.





## 2. Basic Operation

### 2.1 Power ON/OFF(Optional)

- Connect the power cord to the **AC input**. Insert the power cord into the appropriate socket.
- Press the **Power switch** to switch on the TV, then press **Power** button to turn on the unit.
- Press the **Power switch** again to switch off the TV.

Note: After switch off the TV, please don't immediately re-open the power switch ,should be delayed one minute more to re-open the power switch.

### 2.2 Setting of Standby Mode

- Press (  ) button to turn on the unit.
- Press (  ) button again to return the display to standby mode. The power indicator turns red.
- Be sure not to set your TV in standby mode for a long period of time.

---

## 2.3 Selection of Input Mode

This set has different signal source modes, you may continue to press the **SOURCE** button to select a signal source.

## 2.4 Menu Functions

This chapter will describe the function of Picture in main menu.

### PICTURE Menu



#### Picture Mode

Press **▲/▼** button to select Picture Mode, then press **ENTER** button to enter and press **▲/▼** button to select.

#### Brightness

Press **▲/▼** button to select Brightness, then press **ENTER** button to enter and press **◀/▶** button to adjust. Then press **MENU** button to return back the previous menu directly.

#### Contrast

Press **▲/▼** button to select Contrast, then press **ENTER** button to enter and press **◀/▶** button to adjust. Then press **MENU** button to return back the previous menu directly.

#### Sharpness

Press **▲/▼** button to select Sharpness, then press **ENTER** button to enter and press **◀/▶** button to adjust. Then press **MENU** button to return back the previous menu directly.

#### Colour

Press **▲/▼** button to select Colour, then press **ENTER** button to enter and press **◀/▶** button to adjust. Then press **MENU** button to return back the previous menu directly.

#### Tint

Press **▲/▼** button to select Tint, then press **ENTER** button to enter and press **◀/▶** button to adjust. Then press **MENU** button to return back the previous menu directly.

#### Colour Temperature

Press **▲/▼** button to select **Colour Temperature**, then press **ENTER** button to enter and **◀/▶** button to select.

#### Aspect Ratio

Press **▲/▼** button to select **Aspect Ratio**, then press **ENTER** button to enter and **◀/▶** button to select.

#### Noise Reduction

Press **▲/▼** button to select **Noise Reduction**, then press **ENTER** button to enter and **◀/▶** button to select.

---

## Sound Menu



### Sound mode

Press ▲/▼ button to select **Sound mode**, and then press **ENTER** button to enter. And then press ◀/▶ button to select.

### Bass

Press ▲/▼ button to select **Bass**, then press **ENTER** or ▶ button to enter and press ◀/▶ button to adjust. It can only be adjusted under user mode. Then press **MENU** button to return back the previous menu directly.

### Treble

Press ▲/▼ button to select **Treble**, then press **ENTER** button to enter and press ◀/▶ button to adjust. It can only be adjusted under user mode. Then press **MENU** button to return back the previous menu directly.

### Balance

Press ▲/▼ button to select **Balance**, then press **ENTER** button to enter and press ◀/▶ button to adjust. Then press **MENU** button to return back the previous menu directly.

### Surround

Press ▲/▼ button to select **Surround**, and then press **ENTER** button to enter and press ◀/▶ button to select ON or OFF.

### AVL

Press ▲/▼ button to select **AVL**, and then press **ENTER** button to enter and press ◀/▶ button to select ON or OFF.

### SPDIF

Press ▲/▼ button to select **SPDIF**, and then press **ENTER** button to enter and press ◀/▶ button to select.

### Audio Description

Press ▲/▼ button to select **Audio Description**, and then press **ENTER** button to enter and press ▶ button to enter the sub-menu.

---

## Channel Menu



### Channel Management

Press ▲/▼ button to select **Channel Management**, and then press **ENTER** button to rename the channel selected.

### Favorite Management

Press ▲/▼ button to select **Favorite Management**, and then press **ENTER** button to the Favorite Management menu.

### TV Connection

Press ▲/▼ button to select **TV Connection**, and then press **ENTER** button to select which the TV connect type you use.

### Auto Tuning

Press ▲/▼ button to select **Auto Tuning**, and then press **ENTER** button to enter

### DTV Manual Search

Press ▲/▼ button to select **DTV Manual Search**, and then press **ENTER** button to start the scan.

### ATV Manual Search

Press ▲/▼ button to select **ATV Manual Search**, and then press **ENTER** button to start the scan the ATV channels.

### LCN On/Off

Press ▲/▼ button to select **LCN On/Off**, and then press **ENTER** button to set LCN to on or off.

---

## Feature Menu



### Lock

Press ▲/▼ button to select **Lock**, then press **ENTER** button to enter the sub menu with the password "0000":

### Language

Press ▲/▼ button to select **Language**, then press **ENTER** or ► button to enter the sub menu, then press ▲/▼ button to select, then press **ENTER** or ► button to confirm.

### Sleep Timer

Press ▲/▼ button to select **Sleep Timer**, then press **ENTER** button to enter and press ▲/▼ button to select.

### Auto Power Off

Press ▲/▼ button to select **Auto Power Off**, then press **ENTER** to enter the sub menu, Then Press ▲/▼ to select off, 1 hour, 2 hours, 4 hours then press **ENTER** to confirm. (When the PC signal is connected).

### Hearing Impaired

Press ▲/▼ button to select **Hearing Impaired**, then press **ENTER** button to enter and press ▲/▼ button to select off or on.

### CI Info

Press ▲/▼ button to select **CI info**, then press **ENTER** button to display the CI slot Information.

### PVR/TimeShift

Press ▲/▼ button to select **PVR/TimeShift**, then press **ENTER** button to open the sub-menu.

---

## Setup Menu



### OSD Timer

Press ▲/▼ button to select **OSD Timer**, and then Press **ENTER** or ► button to select.

### Blue Screen

Press ▲/▼ button to select **Blue Screen**, and then Press **ENTER** or ► button to select on or off.

### Home Mode

Press ▲/▼ button to select **Home Mode**, and then Press ◀/▶ button to select Home or Store, then press **ENTER** button to confirm.

### Reset TV Setting

Press ▲/▼ button to select **Reset TV Setting**, and then Press then press **ENTER** button to enter the sub menu, enter the password if locked, and then you can quickly make some basic settings of the TV.

### Version

Press ▲/▼ button to select **Version**, and then press **ENTER** to enter the sub menu, you can check the software version this TV.

---

## 2.5 Multimedia

### 1. Photo

#### 1.1 Function Introduction

Highlight the "PHOTO" item in multimedia mainmenu by press "RIGHT" / "LEFT" key, then press "ENTER"



#### Key Operation









- 1) RED: Delete the focused folder/file.
- 2) GREEN: Add/Del all photo files to play list.
- 3) ENTER: Add/Del highlight files to play list.
- 4) CH+/-: Page up/Page down.
- 5) PLAY: Play the files in play list.

#### 1.1.1 Playback

Press "PLAY" key to start playback.



#### Key Operation

- 1) : Same as "PLAY" key on remote, to start playing pictures in slide show mode
- 2) : Same as "PAUSE" key on remote, to pause the playing file
- 3) : Same as "STOP" key on remote, to stop sliding show, and return to the file browser
- 4) : Same as "|<<" / ">>|" key on remote, to play the previous or next file directly
- 5) : To rotate the playing picture(0 °、90 °、180 °、270°).
- 6) : To zoom the playing picture.
- 7) : Same as "INFO" key on remote, to display the information of the current file.
- 8) : To enter "Photo Setup" menu, including "Repeat Mode", "Background Music", "Music Source", "Slide Time", "Effect".
- 9) : To enter the play list menu.



## 2. Music

### 2.1 Function Introduction

Highlight the "MUSIC" item in multimedia mainmenu by press "RIGHT" / "LEFT" key, then press "ENTER"

key enter music page, as follow:



#### Key Operation









- 1) RED: Delete the focused folder/file.
- 2) GREEN: Add/Del all music files to play list.
- 3) ENTER: Add/Del highlight files to play list.
- 4) CH+/-: Page up/Page down.
- 5) PLAY: Play the files in play list.

#### 2.1.1 Playback

Press "PLAY" key to start playback.



#### Key Operation

- 1) : Same as "PLAY" key on remote, to start playing file, or resume the paused file.
- 2) : Same as "PAUSE" key on remote, to pause the playing file
- 3) : Same as "STOP" key on remote, to stop the playing file.
- 4) : Same as "<<" / ">>" key on remote, to play fast backward or forward. The speed can switch to twice, four times, eight times and sixteen times, and displayed with "X2, X4, X8, X16" on screen.
- 5) : Same as "|<<" / ">>|" key on remote, to play the previous or next file directly.
- 6) : To switch the repeat mode, including "Repeat 1", "Repeat All", "Repeat Dir" and "Random" modes.
- 7) : To switch the window between "Information" and "Play List".
- 8) : Same as "BLUE" key on remote, to close the panel only in "MUSIC" mode, and then it can be opened by every key on remote.

### 3.Movie

Highlight the "MOVIE" item in multimedia main menu by press "RIGHT" / "LEFT" key, then press "ENTER" key enter movie page, as follow:



#### Key Operation

- 1) RED: Delete the focused folder/file.
- 2) GREEN: Add/Del all movie files to play list.
- 3) ENTER: Add/Del highlight files to play list.
- 4) CH+/-: Page up/Page down.
- 5) PLAY: Play the files in play list.

### 3.1 Playback

Press "PLAY" key to start playback.



#### Key Operation

- 1) : Same as "PLAY" key on remote, to start playing file, or resume the paused file.
- 2) : Same as "PAUSE" key on remote, to pause the playing file
- 3) : Same as "STOP" key on remote, to stop the playing file, and return to the file browser interface.
- 4) : Same as "<<" / ">>" key on remote, to play fast backward or forward. The speed can switch to twice, four times, eight times and sixteen times, and displayed with "X2", "X4", "X8", "X16" on screen
- 5) : Same as "|<<" / ">>|" key on remote, to play the previous or next file directly.
- 6) : To enter slow mode. The speed can switch to 1/2, 1/4, 1/8, 1/16, and displayed with "X1/2", "X1/4", "X1/8", "X1/16" on screen.
- 7) : To enter step mode.
- 8) : To set AB repeat, the first press sets A point, and the second press sets B point, and then play between A and B repeatedly.
- 9) : To enter the play list menu.
- 10) : Same as "INFO" key on remote, to display the information of the current file.
- 11) : To enter "Movie Setup" menu, including "Program", "Subtitle", "Audio", "Repeat Mode".
- 12) : To enter "GO TO" function, user can input the time he want to start directly.

---

## 4. eBook

### 4.1 Format Supported

Only txt format eBook is supported.

### 4.2 Function Introduction

Highlight the "eBook" item in multimedia main menu by press "RIGHT" / "LEFT" key, then press "ENTER" key enter eBook page, as follow:



#### Key Operation

- 1) RED: Delete the focused folder/file.
- 2) GREEN: Add/Del all txt files to play list.
- 3) ENTER: Add/Del highlight files to play list.
- 4) CH+/-: Page up/Page down.
- 5) PLAY: Play the files in play list.

#### 4.2.1 Playback

Press "PLAY" key to start playback

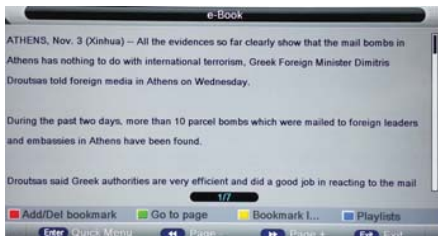

#### Key Operation

- "RED" To add/del bookmark.
- "GREEN" To input the page number directly.
- "YELLOW" To enter the "Bookmark list" page.
- "BLUE" To enter the "Play list" page.
- "<<" / ">>" To page down/page up.
- "EXIT" To close the file and return to the file browser.

### 3. Technical Specification

Product Model	32DTV230E	
Screen Size	32" diagonal	
Aspect Ratio	16:9	
Power Supply	AC 100-240V~,50/60Hz	
Power Consumption	60W	
TV System	PAL B/G/D/K I,SECAM B/G D/K DVB-T/T2/C/S/S2(s/s2 option) (There is no DVB-C signal in some Countries or Areas.)	
Audio Output Power (Internal)	8Wx2	
Input Terminal	Antenna Input	x 2 (S2 option)
	USB Input	x 1
	HDMI Input	x 2
	VGA Input	NO
	PC AUDIO Input	NO
	Audio Input (L/R)	x 1
	Video Input	x 1
	YPbPr Input	x 1(mini)
	RJ45 Input	NO
	CI card In	x 1
	SCART In/Output	NO
	DC In (12V)	NO
Output Terminal	Earphone	x 1
	Audio Line Out(L/R)	NO
	Video Output	NO
	Optical	NO
	Coaxial out	x 1
Working Temperature	0°C~40°C	
Working Humidity	20% ~ 80% Non-condensing	

*Note:the specification shown above may change without notice for quality improvement.*

---

## 4. Supported Signal Modes

### A.YPbPr Mode

Resolution	Horizontal Frequency (Khz)	Vertical Frequency (Hz)
480i	15.734	59.94
480p(720x480)	31.468	59.94
576i	15.625	50.00
576p(720x576)	31.25	50.00
720p(1280x720)	37.50	50.00
	45.00	60.00
1080i	28.13	50.00
	33.75	60.00
1080P(1920x1080)	67.50	60.00
	56.25	50.00

### B.HDMI Mode

Resolution	Horizontal Frequency (Khz)	Vertical Frequency (Hz)
480p	31.468	59.94
576p	31.25	50.00
720P	45.00	60.00
1080i	33.75	60.00
1080P(1920x1080)	67.50	60.00

*-When the signal received by the Display exceeds the allowed range, a warning message will appear on the screen.*

*-You can confirm the input signal format onscreen.*

---

## 5. Simple Troubleshooting

If the display fails or the performance changes dramatically, check the Display in accordance with the following instructions. Remember to check the peripherals to pinpoint the source of the failure.

Symptom	Solution
Power cannot be turned on.(Power indicator does not light.)	-Check that both ends of the power cable are plugged into the socket appropriately and the wall socket is operational.
No Input Signal message appears.	-Check that the signal line is connected properly. -Check that the power of the relevant peripherals is turned on. -Check that the Input option that has been selected matches with the input signal.
The remote control does not function properly.	-Check the batteries are not drained.(Use new batteries.) -Check that the remote control is within the operating range. -Check that the remote control is pointed to the remote control window on the display. -Check that there are no obstacles between the remote control and the remote control window.
Flashing spots or stripes appear on the screen.	-Check that there are no emission (Car, HV cable or Neon lamp) or other possible interference sources.
Image colour or quality deteriorates.	-Check that all the video settings are adjusted appropriately, such as brightness, contrast, colour etc. -For more information about video settings, refer to OSD Functions in Chapter 2.
Screen position and size are incorrect.	-Check that the screen position and size is adjusted appropriately.
Image or colour is incorrect.	-Check that the signal line is connected properly. -When connecting to a PC, you can change the resolution of the PC to acquire the correct image. The discrepancy of the PC output signal may affect the display of the image.
Display warning message.	-Check that the input signal line is properly fixed. -Select the correct input signal. -For more information, refer to Supported Signal Modes in Chapter 4.



Nadamo se da ste pažljivo pročitali uputstva i da ćete ih se pridržavati. Za više informacija o FOX uređajima posetite našu internet stranicu:

**[www.foxelectronics.rs](http://www.foxelectronics.rs)**

Ovaj dokument je originalno proizveden i objavljen od strane proizvođača, brenda FOX, i preuzet je sa njihove zvanične stranice. S obzirom na ovu činjenicu, Tehnoteka ističe da ne preuzima odgovornost za tačnost, celovitost ili pouzdanost informacija, podataka, mišljenja, saveta ili izjava sadržanih u ovom dokumentu.

Napominjemo da Tehnoteka nema ovlašćenje da izvrši bilo kakve izmene ili dopune na ovom dokumentu, stoga nismo odgovorni za eventualne greške, propuste ili netačnosti koje se mogu naći unutar njega. Tehnoteka ne odgovara za štetu nanесenu korisnicima pri upotrebi netačnih podataka. Ukoliko imate dodatna pitanja o proizvodu, ljubazno vas molimo da kontaktirate direktno proizvođača kako biste dobili sve detaljne informacije.

Za najnovije informacije o ceni, dostupnim akcijama i tehničkim karakteristikama proizvoda koji se pominje u ovom dokumentu, molimo posetite našu stranicu klikom na sledeći link:

<https://tehnoteka.rs/p/fox-televizor-32dtv230e-akcija-cena/>