

Informacije o proizvodu

A-DATA SSD 2TB AGAMMIXS11P-2TT-C



Tehnoteka je online destinacija za upoređivanje cena i karakteristika bele tehnike, potrošačke elektronike i IT uređaja kod trgovinskih lanaca i internet prodavnica u Srbiji. Naša stranica vam omogućava da istražite najnovije informacije, detaljne karakteristike i konkurentne cene proizvoda.

Posetite nas i uživajte u ekskluzivnom iskustvu pametne kupovine klikom na link:

<https://tehnoteka.rs/p/a-data-ssd-2tb-agammixs11p-2tt-c-akcija-cena/>



XPG GAMMIX S11 Pro PCIe Gen3x4 M.2 2280

**REMAINS COOL
AT BLAZING
SPEEDS**



XPG GAMMIX S11 Pro PCIe Gen3x4 M.2 2280 Solid State Drive

Employing the extra-fast PCIe Gen3x4 interface and supporting NVMe 1.3, the GAMMIX S11 Pro delivers blazing fast read/write speeds of up to 3500/3000MB per second. What's more, the S11 Pro is encased in a heatsink that reduces the SSD's temperatures by up to 10°C. Equipped with 3D NAND Flash along with SLC Caching, a DRAM Cache Buffer, End-to-End Data Protection, and LDPC ECC technology, it maintains high speeds and data integrity even during intense gaming, rendering, overclocking, and other high-demand applications.

Features

- Ultra-fast PCIe Gen3x4 interface:
R/W speed up to 3500/3000MB/s
- NVMe 1.3 support
- 3D NAND Flash for higher capacity and durability
- Unique heatsink design – makes SSD 10°C cooler
- Advanced LDPC ECC Technology
- SLC Caching and DRAM cache buffer
- E2E Data Protection and RAID Engine
- Compact M.2 2280 form factor – ideal for gaming and high-end desktops

Ordering Information

Capacity	Model Number	EAN Code
256GB	AGAMMIXS11P-256GT-C	4710273770758
512GB	AGAMMIXS11P-512GT-C	4710273770765
1TB	AGAMMIXS11P-1TT-C	4710273770772
2TB	AGAMMIXS11P-2TT-C	4710273773568



Specifications

- Capacities: 256GB / 512GB / 1TB / 2TB
- NAND Flash: 3D NAND
- Interface: PCIe Gen3x4
- Form Factor: M.2 2280
- MTBF: 2,000,000 hours
- Dimensions (L x W x T): 80 x 22 x 6.1mm
- Weight: 11g / 0.38oz
- Power Consumption: 0.33W Active (Typical), 0.14W Slumber (Typical) (*measured by power meter)
- Operating Temperature: 0°C~70°C
- Storage Temperature: -40°C~85°C
- Shock Resistance: 1500G/0.5ms
- Warranty: 5-year limited
- Certifications: RoHS, CE, FCC, BSMI, VCCI, KC, RCM, UKCA, Morocco

Performance

Capacity	Sequential Performance (Up to) ¹		4K Random (Up to) ¹		TBW ²
	Read (MB/s)	Write (MB/s)	Read (IOPS)	Write (IOPS)	
256GB	3,500	1,200	220K	290K	160TB
512GB	3,500	2,300	390K	380K	320TB
1TB	3,500	3,000	390K	380K	640TB
2TB	3,500	3,000	360K	360K	1280TB

¹Performance may vary based on SSD capacity, hardware test platform, test software, operating system and other system variables

²The value is the minimum amount of terabyte written that could be reached.

Schematics

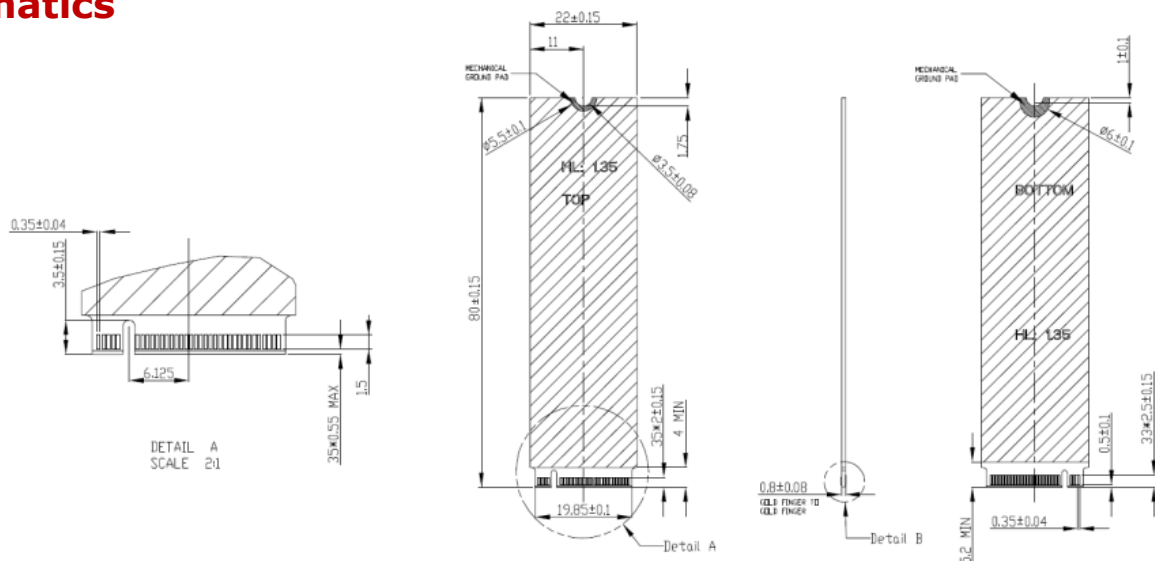

Ovaj dokument je originalno proizveden i objavljen od strane proizvođača, brenda Adata, i preuzet je sa njihove zvanične stranice. S obzirom na ovu činjenicu, Tehnoteka ističe da ne preuzima odgovornost za tačnost, celovitost ili pouzdanost informacija, podataka, mišljenja, saveta ili izjava sadržanih u ovom dokumentu.

Napominjemo da Tehnoteka nema ovlašćenje da izvrši bilo kakve izmene ili dopune na ovom dokumentu, stoga nismo odgovorni za eventualne greške, propuste ili netačnosti koje se mogu naći unutar njega. Tehnoteka ne odgovara za štetu nanесenu korisnicima pri upotrebi netačnih podataka. Ukoliko imate dodatna pitanja o proizvodu, ljubazno vas molimo da kontaktirate direktno proizvođača kako biste dobili sve detaljne informacije.

Za najnovije informacije o ceni, dostupnim akcijama i tehničkim karakteristikama proizvoda koji se pominje u ovom dokumentu, molimo posetite našu stranicu klikom na sledeći link:

<https://tehnoteka.rs/p/a-data-ssd-2tb-agammixs11p-2tt-c-akcija-cena/>