

## Uputstvo za upotrebu

VOX klima SFE18-AA

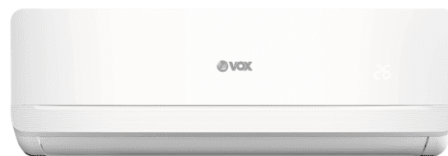

Tehnoteka je online destinacija za upoređivanje cena i karakteristika bele tehnike, potrošačke elektronike i IT uređaja kod trgovinskih lanaca i internet prodavnica u Srbiji. Naša stranica vam omogućava da istražite najnovije informacije, detaljne karakteristike i konkurentne cene proizvoda.

Posetite nas i uživajte u ekskluzivnom iskustvu pametne kupovine klikom na link:

<https://tehnoteka.rs/p/vox-klima-sfe18-aa-akcija-cena/>

# Korisničko uputstvo

Zidni split sistem klima uređaj

---



## Modeli

**SFE09-AA**

**SFE12-AA**

**SFE18-AA**

**SFE24-AA**

**SFG12-SC**

**SFG18-SC**

**SFX09-IO**

**SFX12-IO**

**SFX18-IO**

**SFX24-IO**

Molimo da pažljivo i detaljno pročitate  
ovo uputstvo pre rukovanja sa uređajem!  
Sačuvajte ovo uputstvo za kasniju upotrebu.

# SADRŽAJ

## Upotreba i održavanje

Bezbednosne informacije .....	1
Napomene za upotrebu .....	6
Imena delova.....	8
Čišćenje i održavanje .....	9
Rešavanje problema .....	10

## Postavljanje i servisiranje

Napomene za postavljanje.....	12
Postavljanje unutrašnje jedinice .....	15
Postavljanje spoljne jedinice .....	18
Provera nakon postavljanja i test funkcionisanja .....	21

Napomena: Sve slike u ovom uputstvu su samo šematski prikazi.

# Bezbednosne informacije

Nepravilno postavljanje ili upotreba usled nepoštovanja datih uputstava može da izazove povrede ili štetu osobama, imovini, itd.

Stepen ozbiljnosti klasifikovan je na sledeći način:

## UPOZORENJE !

Ovaj simbol označava mogućnost smrtnog ishoda ili ozbiljne povrede.



## OPOMENA !

Ovaj simbol označava mogućnost povrede ili oštećenja imovine.

## UPOZORENJE !

Ovim uređajem mogu upravljati deca iznad 8 godina i osobe sa smanjenim fizičkim, senzornim ili mentalnim sposobnostima, ili sa nedostatkom iskustva i znanja ukoliko su pod nadzorom ili su im data uputstva za rukovanje uređajem na bezbedan način i ukoliko razumeju opasnost do koje može doći. Deca se ne smeju igrati s uređajem. Čišćenje i održavanje uređaja ne treba poveriti deci bez nadzora. (Samo za klima uređaje sa oznakom CE)

Ovaj uređaj nije namenjen za upotrebu od strane osoba (uključujući decu) sa smanjenim fizičkim, senzornim ili mentalnim sposobnostima, ili nedostatkom iskustva i znanja, osim ukoliko su pod nadzorom ili su ima data uputstva od osobe odgovorne za njihovu bezbednost. Decu treba nadzirati kako biste se uverili da se ne igraju s uređajem. (Osim kod klima uređaja sa oznakom CE)

# Bezbednosne informacije

Klima uređaj mora biti uzemljen. Nepotpuno uzemljenje uređaja može dovesti do elektrošoka.



Ne povežite uzemljenje na uzemljenje gasovoda, vodovoda, gromobrana ili telefona.

Izvucite utikač (ili isključite osigurač) Ukoliko uređaj nećete koristiti duže vreme kako biste osigurali bezbednost.

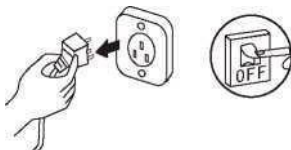

Pre nego što uključite utikač, uverite se da nema prašine na njemu, i da je u potpunosti uključen.



Ukoliko je napojni kabl oštećen, mora biti zamenjen od star ne proizvođača ili ovlašćenog servisera.



Ne izvlačite utikač tokom rada uređaja mokrim rukama.



Može prouzrokovati elektrošok ili požar.

Vodite računa da se daljinski i unutrašnja jedinica ne nakvase previše niti da budu dugo vlažni.



(NE!)

U suprotnom, može dovesti do kratkog spoja ili požara.

Uvek isključite uređaj i napajanje pre bilo kakvog čišćenja i održavanja uređaja.



U suprotnom, može dovesti do kratkog spoja ili oštećenja.

Ne vucite kabal prilikom isključivanja iz utičnice.

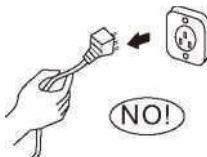

Šteta nastala povlačenjem kabla direktno može prouzrokovati elektrošok.

Nemojte deliti utičnicu sa drugim električnim uređajima.

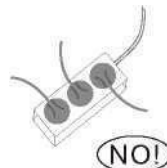

U suprotnom, može dovesti do kratkog spoja ili požara.

# Bezbednosne informacije

Nemojte postavljati uređaj na mestu blizu zapaljivog gasa ili tečnosti. Rastojanje među njima mora biti više od 1m.

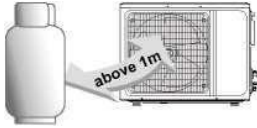

Može dovesti do elektrošoka.

Nemojte koristiti tečnost ili korozivno sredstvo za čišćenje klima uređaja niti posipati vodom ili drugom tečnošću.



Može dovesti do požara ili oštećenja uređaja.

Nemojte pokušavati da sami popravljate klima uređaj.

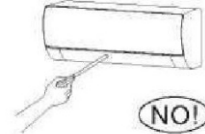

Nepravilna popravka može uzrokovati elektrošok ili požar. Kontaktirajte ovlašćenog servisera za sve vrste popravki.

Nemojte koristiti klima uređaj po olujnom vremenu.

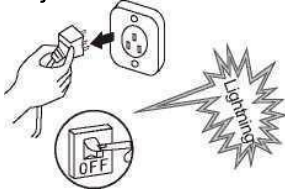

Prekidač treba da bude isključen kako bi sprečili pojavu oštećenja.

Ne stavljajte ruke ili bilo koji drugi predmet u odvodna i dovodna creva.

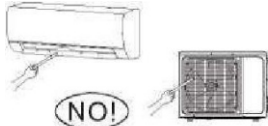

Ovo može dovesti do povrede osobe ili oštećenja uređaja.

Molimo proverite da li je postavljeno Postolje za spoljnu jedinicu dovoljno čvrsto ili ne.

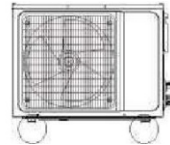

Ukoliko je oštećeno, može dovesti do pada jedinice i uzrokovati povredu.

Nemojte stavljati prepreke u blizini dovoda i odvoda vazduha.

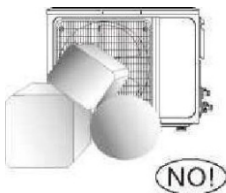

U suprotnom, kapacitet hlađenja ili grejanja će oslabiti, čak može dovesti i do prestanka rada uređaja.

Nemojte dozvoliti da klima uređaj duva u pravcu grejnog tela.



U suprotnom će dovesti do nepotpunog sagorevanja, uzrokujući moguće trovanje.

Osigurač za potrošnju struje mora biti postavljen kako bi se sprečio mogući elektrošok.

Uređaj mora biti instaliran u skladu sa zakonskim propisima za povezivanje strujnog kola.

## Bezbednosne informacije

Ovaj proizvod sadrži fluorovane gasove s efektom staklene bašte.

Curenje rashladnog sredstva doprinosi klimatskim promenama. Rashladno sredstvo sa nižim stepenom grejne snage (GWP) manje doprinosi globalnom zagrevanju nego sredstvo sa višim stepenom grejne snage, ukoliko se otpusti u atmosferu. Ovaj uređaj sadrži rashladno sredstvo sa snagom GPW 2088. To znači da ako 1l ovog rashladnog sredstva treba da se otpusti u atmosferu, uticaj na globalno zagrevanje će biti 2088 puta veće od oslobađanja 1kg CO<sub>2</sub>, za period od preko 100 godina. Nikada ne pokušavajte da sami dirate rashladno kolo ili rastavljate uređaj i uvek tražite pomoć kvalifikovanog servisera.

### UPOZORENJE WEEE

Značenje precrtanog kontejnera za smeće:

Ne odlažite električne uređaje kao nesortirani otpad, koristite odvojene prostorije za sakupljanje.

Kontaktirajte Vašu lokalnu upravu kako biste dobili informacije u vezi sa raspoloživim sistemima za sakupljanje otpada.

Ukoliko se električni otpad odloži na deponiju ili smetlišta, opasne materije mogu da procure u podzemne vode, uđu u lanac ishrane, škodeći zdravlju i blagostanju.

Prilikom zamene starih uređaja novim, prodavac je zakonski obavezan da preuzme stari uređaj i odloži ga bez novčane naknade .



# Bezbednosne informacije

Nemojte dugo držati otvorene prozore i vrata dok je klima uređaj uključen



U suprotnom kapacitet hlađenja ili grejanja će biti oslabljen.

Nemojte izlagati telo hladnom vazduhu na duži period.



To će pogoršati fizičke uslove i uzrokovati zdravstvene probleme.

## MERE OPREZA

Nemojte stajati na spoljašnjoj jedinici niti stavljati teške stvari na nju.

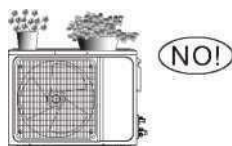

Ovo može prouzrokovati povredu osobe ili dovesti do oštećenja uređaja.

Podesite pogodnu temperaturu.

Preporučuje se da razlika između unutrašnje i spoljašnje temperature ne bude prevelika.

Odgovarajuće korekcije podešavanja temperature mogu sprečiti rasipanje električne energije.

Nemojte koristiti klima uređaj kao što je sušenje veša, čuvanje hrane itd.



Ukoliko Vaš klima uređaj nije opremljen kablom i utikačem, jednopolni prekidač mora biti postavljen u fiksnu instalaciju i razdaljina između kontakata ne sme biti manja od 3.0 mm.

Ukoliko je Vaš uređaj trajno povezan na žičnu konstrukciju, (RCD) uređaj za diferencijaciju struje koji ne prelazi 30 mA treba da se postavi.

Strujno napojno kolo treba da ima zaštitnik za curenje i prekidač čiji kapacitet treba da bude 1.5 puta veći od maksimalne struje.

Što se tiče postavljanja klima uređaja, konsultujte odeljke ispod u ovom uputstvu.



# Napomene za upotrebu

## Uslovi u kojima jedinica ne može normalno da radi

- \* Ukoliko nije u temperaturnom opsegu prikazanom u sledećoj tabeli, klima uređaj može prestati s radom i mogu se pojaviti druge nepravilnosti.

Hlađenje	Spoljašnja	>43 C (Primenjuje se za T1 )
		>52°C (Primenjuje se za T3)
	Unutrašnja	<18 C
Grejanje	Spoljašnja	>24C
		<-7C
	Unutrašnja	>27 C

- \* Kada je temperatura previsoka, klima uređaj može aktivirati uređaj za automatsku zaštitu, tako da će se klima uređaj ugasiti.
- \* Kada je temperatura preniska, uređaj za razmenu toplote klima uređaja se može zamrznuti, što može dovesti do curenja vode ili druge nepravilnosti u radu.
- \* U toku dugog hlađenja i isušivanja relativne vlažnosti preko 80% (vrata i prozori su otvoreni), može se javiti kondenzacija vode ili doći do kapanja vode blizu odvoda vazduha.
- \* T1 i T3 odnose se na standard ISO 5151.

## Napomene za grejanje

- \* Ventilator unutrašnje jedinice neće odmah početi s radom nakon početka grejanja kako bi se izbeglo izduvavanje hladnog vazduha.
- \* Kada je napolju hladno i vlažno, kod spoljašnje jedinice može doći do stvaranja mraza iznad uređaja za menjanje toplote što će ugroziti kapacitet grejanja. Ovo će se, kada klima uređaj počne s radom, otopiti.
- \* Tokom otapanja, klima uređaj će prestati s grejanjem otprilike u periodu 5-12 minuta.
- \* Para može izaći iz spoljašnje jedinice tokom otapanja. Ovo nije nepravilnost, već rezultat brzog otapanja.
- \* Grejanje će se nastaviti kada je otapanje u potpunosti gotovo.

## Napomene za isključivanje

- \* Kada je klima uređaj isključen, glavni kontroler će automatski odlučiti da li da odmah stane s radom ili će raditi još desetak sekundi sa smanjenom frekvencijom i brzinom izduvavanja vazduha.

# Napomene za upotrebu

## Rad u vanrednim slučajevima

- \* Ukoliko je daljinski upravljač izgubljen ili polomljen, koristite dugme za forsirani rad klima uređaja.
- \* Ukoliko ovo dugme pritisnete kada je uređaj ugašen, klima uređaj će početi s radom u automatskom režimu rada.
- \* Ukoliko ovo dugme pritisnete kada je uređaj uključen, klima uređaj će prestati s radom.

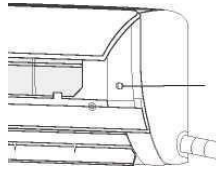

Dugme za forsirani rad

## Podешavanje smera duvanja vazduha

1. Koristite tastere krilca gore-dole i levo-desno na daljinskom upravljaču kako biste podesili smer duvanja vazduha. Za detalje pogledajte uputstvo o korišćenju daljinskog upravljača.
2. Za modele bez mogućnosti duvanja krilaca levo-desno, rebra treba da se pomeraju ručno.

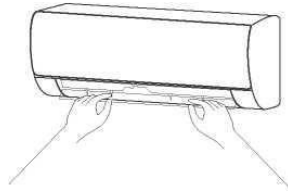

Napomena : Pomerajte krilca pre nego što urađaj počne s radom, jer može doći do povrede Vaših prstiju. Nikada nemojte staviti ruke u dovod ili odvod vazduha u toku rada klima uređaja.

## PAŽNJA

Ukoliko oprema ne zadovoljava tehničke zahteve kompatibilnosti IEC 61000-3-3, sledećeg upozorenja se treba pridržavati.

Pažnja : Ovaj uređaj mora biti povezan samo na napon sa sistemskom impedansom koja ne prelazi vrednost  $Z_{max}$ . Ukoliko je potrebno, molimo da konsultujete Vašeg snabdevača električnom energijom kako biste dobili vrednost sistemske impedanse.

Vrsta proizvoda	Z <sub>max</sub>	Vrsta proizvoda	Z <sub>max</sub>
ASTW-H12L4/#-IQ	0.445	ASTW-(H)18QA2/#R1 -SA	0.331
ASTW-1 2U4/#-AE	0.445	ASTW-20U4/L#-IR	0.07
ASW-H15D3A4/#R1-C5	0.392	ASTW-24G4/#-AE	0.027
ASTW-H18U4/#-IQ	0.128	ASTW-H24C4/#-IQ	0.027
ASTW-1 8U4/#-AE	0.128	ASW-H24F6A4/#R1-C5	0.281
ASW-H18E1A4/#R1-C5	0.422	ASTW-30P4/#-AE	0.026
#=LK700,LF,FLHLI,LM,LN,LR,LU,LS,LD,LP, LQ,L8,LO,LC,LE,LL,ULK700,ULF,ULH,ULM,ULN,ULI,ULS,ULU,ULD,ULP,ULR,ULQ,ULB,ULO,ULC,ULE,ULL,QLK700,QLF,QLH,QLM,QLN,QLI,QLS,QLU,QLD,QLP,QLR,QLQ,QLB,QLO,QLC,QLE,QLLGL,K700,GLF,GLH,GLM,GLN,GU,GLS,GLU,GLD,GLP,GLR,G LQ,GLB,GLO,GLC,GLE,GLL			
ASW-H18E1A4/#R1-RU	0.421	ASW-H24B4/#R1-RU	0.315
ASTW-1 8Q4/#-AE	0.112		
#= FA,FB,FD,FI,FJ,FO,FC,FY,FQ,FM,FR,FF,HH,FVM A			

# Imena delova klima uređaja

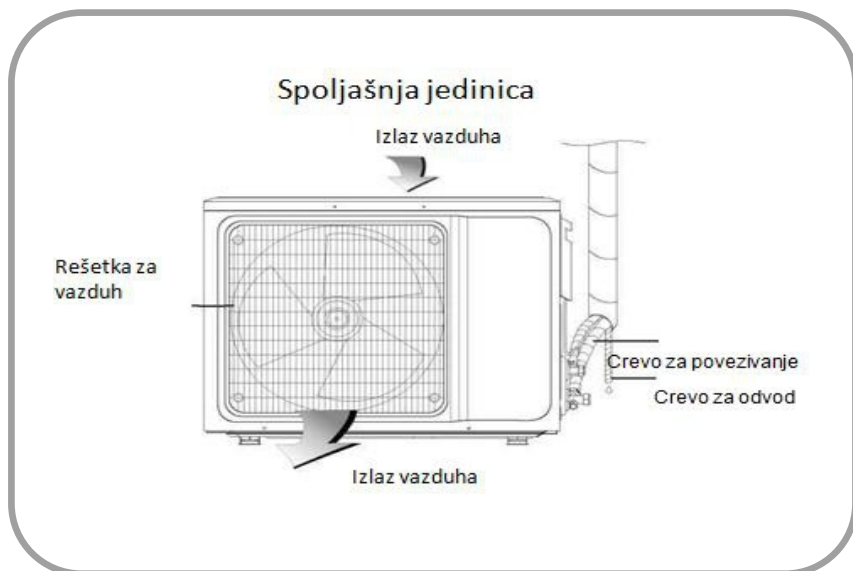
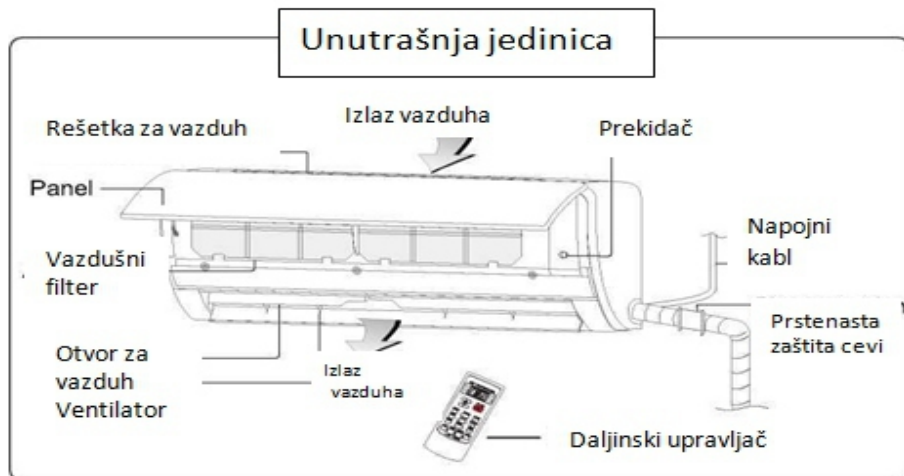

Napomena: Na svim slikama u ovom uputstvu dat je samo šematski prikaz. Stvarni izgled uređaja može se razlikovati.

# Čišćenje i održavanje

## Upozorenje

- Pre čišćenja klima uređaja, on mora biti ugašen i isključen iz zida više od 5 minuta, u suprotnom postoji rizik od elektroškoka.
- Nemojte kvasiti klima uređaj, jer to može prouzrokovati elektrošok. Postarajte se da ni u kom slučaju ne ispirate klima uređaj vodom.
- Isparljive tečnosti kao što su na primer razređivač ili benzin će oštetiti kućište klima uređaja, zato Vas molimo da kućište čistite samo mekov suvom krpom i vlažnom krpom natopljenom neutralnim deterdžentom.
- Tokom upotrebe, vodite računa o redovnom čišćenju filtera, kako biste sprečili gomilanje prašine koja može smanjiti efekte rada uređaja. Ukoliko je u okruženju uređaja dosta prašine, to će povećati broj neophodnih čišćenja uređaja. Nakon uklanjanja filtera, ne dodirujte fini deo unutrašnje jedinice prstom, jer ga možete izgubiti.

## Čišćenje panela

Kada je panel (poklopac) unutrašnje jedinice zaprljan, očistite ga nežno mekom krpom koristeći toplu vodu ispod 45 C, i nemojte pomerati panel tokom čišćenja.

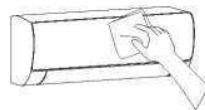

## Čišćenje vazdušnog filtera

- Uklonite vazdušni filter

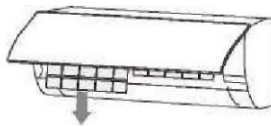
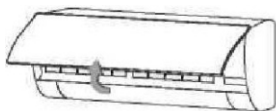

1. Koristite obe ruke da biste otvorili panel držeći u uglo vima na oba kraja panela u smeru strelice.

2. Izvucite vazdušni filter iz ležišta i uklonite ga.

■ Čišćenje vazdušnog filtera

Upotrebite usisivač ili vodom isperite filter, a ukoliko je filter jako zaprljan (na primer masnoćom), čistite ga toplom vodom (ispod 45°C) sa rastvorenim blagim deterdžentom, i ostavite filter da se u hladu osuši napolju.

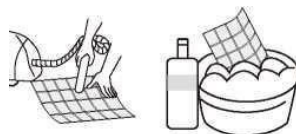

## Očistite vazdušni filter

■ Montirajte filter

1. Postavite osušeni filter u suprotnom smeru od uklanjanja, zatim poklopite i zaključajte ploču.



### Proverite pre upotrebe

1. Proverite da li su otvori za dovod i odvod vazduha odblokirani na jedinicama.
2. Proverite da li dolazi do blokiranja vode u odvodnom crevu, i odmah očistite ukoliko ga ima.
3. Proverite da li je dobro uzemljenje.
4. Proverite da li su baterije postavljene u daljinskom upravljaču, i da li imaju dovoljno snage.
5. Proverite da nije došlo do oštećenja držača za montiranje spoljašnje jedinice, i ukoliko jeste, molimo pozovite ovlašćeni servis.

### Održavanja nakon upotrebe

1. Isključite naponski kabl iz klima uređaja, isključite prekidač i izvadite baterije iz daljinskog upravljača.
2. Očistite filter i telo jedinica.
3. Uklonite prašinu i prljavštinu iz spoljašnje jedinice.
4. Proverite da nije došlo do oštećenja držača za montiranje spoljašnje jedinice, i ukoliko jeste, molimo pozovite ovlašćeni servis.

## Rešavanje problema

### Oprez

\* Nemojte sami popravljati uređaj jer loše održavanje može dovesti do elektroškoka ili požara, Molimo da kontaktirate ovlašćeni servisni centar i prepustite profesionalnom serviseru da vodi brigu o održavanju Vašeg klima uređaja, a provera sledećih stavki pre nego što pozovete za održavanje može uštedeti Vaše vreme i novac.

# Rešavanje problema

## Problem

## Moguće rešenje

Klima uređaj ne radi.	<ul style="list-style-type: none"><li>• Da li je isključena električna energija?</li><li>• Da li je oslabilo povezivanje između žica?</li><li>• Da li je napon previsok ili prenizak?(izmereno od strane ovlašćenog servisera)</li><li>• Da li je podešeno vreme za početak rada?</li><li>• Da li je došlo do spoja uređaja za zaštitu od napona?</li></ul>
-----------------------	---

Daljinski upravljač nije funkcionalan.	<ul style="list-style-type: none"><li>• Da li je daljinski upravljač van efikasne udaljenosti od unutrašnje jedinice?</li><li>• Da li ima prepreka između kontrolora i prijemnika signala?</li><li>• Da li je baterija potrošena?</li></ul>
--	---

Efekat hlađenja/grejanja nije dobar.	<ul style="list-style-type: none"><li>• Da li je pogodna podešena temperatura?</li><li>• Da li je vazdušni filter zaprljan?</li><li>• Da li ima prepreka kod ulaza ili izlaza vazduha?</li><li>• Da li je podešena slaba brzina ventilatora unutrašnje jedinice?</li><li>• Da li ima izvora toplote u Vašoj sobi?</li></ul>
--------------------------------------	---

Unutrašnja jedinica ne radi odmah nakon što je klima uređaj restartovan.	Ukoliko je klima uređaj uključen odmah nakon što je isključen, u cilju zaštite odložiće se početak rada za 3 -5 minuta.
--	---

Oseća se neobičan miris koji izlazi iz uređaja nakon što je uključen.	Sam klima uređaj nema neželjene mirise. Ukoliko se ipak oseća miris, to se može desiti zbog akumuliranja mirisa iz okoline. Molimo očistite vazdušni filter ili aktivirajte funkciju čišćenja.
---	--

Čuje se zvuk tekuće vode tokom rada klima uređaja.	Ponekad se čuje zvuk "pištanja" tekuće vode. Ovo je zvuk protoka rashladnog sredstva, nije kvar.
--	--

Lagani "klik" zvuk se čuje prilikom paljenja ili gašenja uređaja.	Usled temperaturnih promena, radna ploča i ostali delovi će dostići određenu temperaturu uzrokujući zvuk trenja. Ovo je normalno, nije problem.
---	---

Tokom režima hlađenja iz spoljašnje jedinice ponekad izlazi magla.	To je zbog toga što je unutrašnja jedinica veoma brzo ohlađena. Nakon toga uređaj će raditi neko vreme, unutrašnja temperatura i vlažnost će se smanjiti, i magla će nestati.
--	---

Odmah zaustavite sve operacije i isključite dovod struje, i pozovite ovlašćeni servisni centar u sledećim situacijama: ▲ Čuje se prodoran zvuk ili se neprijatan miris emituje tokom rada uređaja. ▲ Napojni kabl i utikač su izuzetno topli. ▲ Slučajno je uređaj ili daljinski upravljač napunjen nečistoćom ili vodom. ▲ Prekidač za vazduh ili zaštitni prekidač se često lomi.	
---	--

# Napomene za postavljanje

## Važne napomene

- Pre instalacije proverite instalatera kod lokalnog ovlašćenog distributera. Ukoliko dođe do kvara, a uređaj je instaliralo lice koje nije ovlašćeno od strane distributera, garancija neće važiti.
- Uređaj mora da bude instaliran od strane ovlašćenog servisa, u skladu sa državnim propisima i prema zahtevima proizvođača.
- Ukoliko želite da promenite lokaciju uređaja, pozovite ovlašćeni servis.

## Zahtevi za postavljanje

- Izbegavajte mesta sa zapaljivim ili eksplozivnim curenjima gasova curenja ili gde postoje veoma agresivni gasovi.
- Izbegavajte mesta sa jakim elektro-magnetnim poljima.
- Izbegavajte bučna mesta.
- Izbegavajte teške prirodne uslove (na primer jake grmljavine, jak vetar, direktnu sunčevu svetlost ili visoke temperature).
- Izbegavajte mesta koja su van domašaja dece.
- Skratite vezu između unutrašnje i spoljašnje jedinice.
- Izaberite gde je lako izvesti servis i popravku i gde je ventilacija dobra.
- Spoljna jedinica ne može da se instalira na bilo koji način koji bi mogao dovesti do zauzimanja prolaza, stepeništa, požarnih stepenica, staze ili bilo koje druge javne površine.
- Spoljašnja jedinica trebalo bi da bude instalirana što dalje od komšijinih vrata i prozora.

## Zahtevi za rad na visini

- Prilikom postavljanja jedinica na 2m ili više iznad nivoa baze, moraju se nositi sigurnosni pojasevi kao i užad dovoljno jaka da se bezbedno pričvrsti na spoljnu jedinicu, kako bi se sprečilo padanje koje bi moglo izazvati telesne povrede ili smrt, kao i materijalnu štetu.

# Napomene za postavljanje

## Zahtevi za montiranje jedinice

- Stalak za montažu mora da ispuni odgovarajuće nacionalne ili industrijske standarde u pogledu snage za zavarivanje i priključivanja oblasti protiv rđanja.
- Stalak za montažu i njegov a nosiva površina mora biti u stanju da izdrže 4 puta više o d težine jedinice, ili 200kg.
- Kod montaže nosača na spoljašnjoj jedinici će biti pričvršćen zavrtanj za proširenje.
- Uverite se da ste osigurali sigurnu instalaciju bez obzira na vrstu zida na kojem je uređaj instaliran, da bi se sprečilo potencijalno kapanja koje bi moglo povrediti ljude.

## Zahtevi za bezbednost od električne energije

- Proverite da li snaga napona, namenjeno strujno kolo za napajanje klima uređaja i prečnik kabla za napajanje ispunjavaju nacionalne zahteve.
- Kada je maksimalna struja klima uređaja  $>16A$ , mora se koristiti prekidač vazduha ili ili uređaj za zaštitu od curenja.
- Normalni radni opseg je 90%-110% lokalnog napona.
- Minimalna udaljenost između klima uređaja i zapaljivih materija je 1.5 m.

## Zahtevi za uzemljenje

- Klima uređaj spada u i vrstu električnih aparata i mora mu se obezbediti pouzdano uzemljenje.
- Nemojte povezivati uzemljenu žicu na cevi za gas, vodovodne cevi, gromobran, telefonske žice ili slabo uzemljena strujna kola.
- Žica za uzemljenje je specijalno dizajnirana i ne može se koristiti u druge svrhe, niti se može učvrstiti običnim šrafovim.



# Napomene za postavljanje

## Ostalo

- Način za povezivanje klima uređaja i naponskog kabla kao i način povezivanja svakog nezavisnog elementa ima šematski prikaz dodat uz uređaj.
- Model i snaga osigurača takođe mora biti odštampana.

## Sadržaj pakovanja unutrašnje jedinice

BR.	NAZIV	KOLIČINA	MERA
1	Unutrašnja jedinica	1	Set
2	Daljinski upravljač	1	Kom
3	Baterije	2	Kom
4	Uputstvo	1	Set
5	Odvodno crevo	1	Kom

## Sadržaj pakovanja spoljašnje jedinice

BR.	NAZIV	KOLIČINA	MERA
1	Spoljašnja jedinica	1	Set
2	Crevo za povezivanje	2	Kom
3	Plastična traka	1	Rolna
4	Zaštitni prsten za crevo	1	Kom
5	Luting (putty)	1	<b>PAKET</b>

NAPOMENA: Svi dodatni delovi si deo trenutno otvorenog pakovanja, te ukoliko ima razlike s Vašim uređajem, molimo za razumevanje.

# Postavljanje unutrašnje jedinice

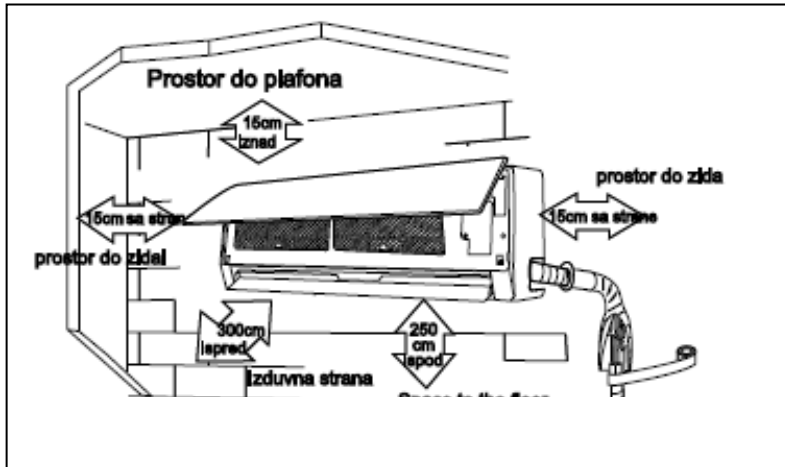

## Postavljanje montažne ploče

1. Zid na kome ćete postaviti unutrašnju jedinicu mora biti čvrst, kako bi sprečio vibracije.
2. Koristiti tip krstastih šrafova kako biste pričvrstili kuke za zid. Uverite se da je montažna ploča dovoljno čvrsta da može da izdrži težinu jedinice.
3. Povucite zakačaljke rukom posle postavljanja da se uverite da su čvrsto vezane za zid.

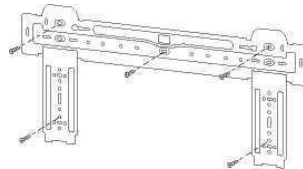

## Bušenje rupa za cevi

1. Napravite rupu uz pomoć električne bušilice ili burgijom na unapred određene pozicije, sa spoljnim nagibom 5 -10
2. Da biste zaštitili cevi i kablove od oštećenja koja prolaze kroz zid, kao i od eventualnih glodara koji se nastanjuju u zidne šupljine, zaštitni prsten se zalemi i zapečati kitom.

Napomena: Rupe su obično debljine  $\phi 60\text{mm}$  –  $\phi 80\text{mm}$ .

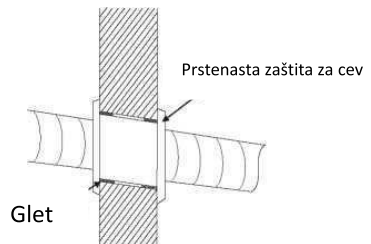

# Postavljanje spoljašnje jedinice

## Rotiranje creva

1. U zavisnosti od položaja jedinice, cevi može biti usmerene bočno sa leve ili desne strane (slika1), ili vertikalno od pozadi (slika 2) (u zavisnosti od dužine cevi unutrašnje jedinice). U slučaju bočnog postavljanja, preseći izlaz na suprotnoj strani
2. Kabal za napajanje može biti postavljen zasebno od creva. Presecite zaštitu i povucite kabl kroz rupu, držeći preostali deo kao zaštitu od glodara.



Fig 1

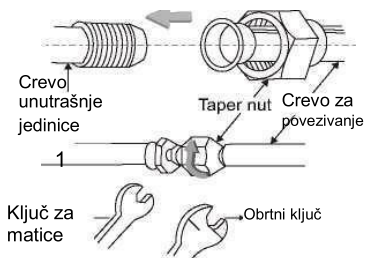

Fig 2

## Povezivanje cevi

1. Uklonite nosače i povucite crevo za unutrašnju jedinicu iz kućišta.
2. Povežite crevo za unutrašnju jedinicu :  
Koristeći ključ za matice i obrtni ključ povežite crevo , smer je prikazan na slici desno. Sila zatezanja je prikazana u tabeli.

Prečnik navoja (mm)	Sila zatezanja (N • m)
0 6 / 0 6 . 3 5	15—25
0 9 . 5 2	35—40
0 1 2 / 0 1 2 . 7	45—60
0 1 5 . 8 8	73—78
0 1 9 . 0 5	85—90



## Obmotajte crevo

1. Koristite izolir traku da spojite delove unutrašnje jedinice i creva za povezivanje, a zatim uz pomoć izolacionog materijala obmotajte creva i zatvorite dobro kako bi se sprečilo stvaranje kondenzata vode na spoju.
2. Povežite izlaz za vodu sa odvodnom cevi, i čvrsto i pravo postavite spojena creva i kablove.
3. Koristite plastične pričvršćivače kako biste obmotali crevo za povezivanje, kablove i odvodno crevo. Pustite da slobodno pada nadole.



# Postavljanje unutrašnje jedinice

## Fiksiranje unutrašnje jedinice

1. Okačite unutrašnju jedinicu na kačaljke, i pomerajte uređaj levo desno da se uverite da su kuke dobro i čvrsto postavljene.
2. Gurnite ka donjoj levoj i gornjoj desnoj strani jedinicu prema kačaljka, dok kuka koja je postavljena ne uradi "klik".

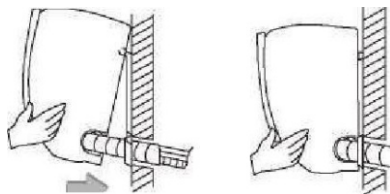

## Prikaz za povezivanje žica

Ukoliko je uz klima uređaj obezbeđen kabl, žično povezivanje je fabrički odrađeno, tako da nema potrebe za povezivanjem.

Ukoliko kabl nije obezbeđen, potrebno je povezivanje prema šematskom prikazu.

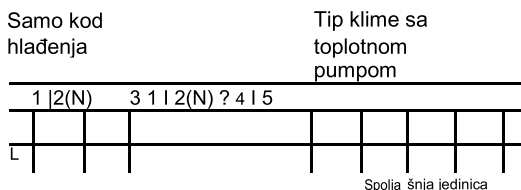

Konektor

Za spoljašnju jedinicu

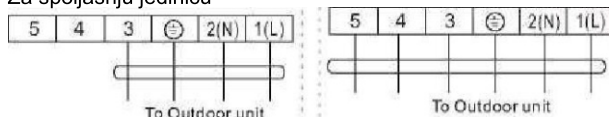

Ukoliko postoji konektor, povežite direktno.

### NAPOMENA:

Ovaj priručnik je obično uključuje režim kablova za različite vrste klima uređaja. Ne možemo isključiti mogućnost da su neki drugi tipovi uređaja isto prikazani na šemi. Šematski prikaz je samo referenca. Ako je uređaj malo drugačiji, pogledajte detaljno šematski prikaz za povezivanje uređaja koji ste kupili.

# Postavljanje spoljašnje jedinice

## Šematski prikaz

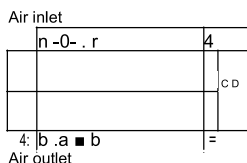
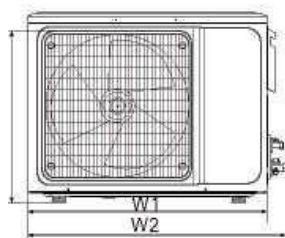
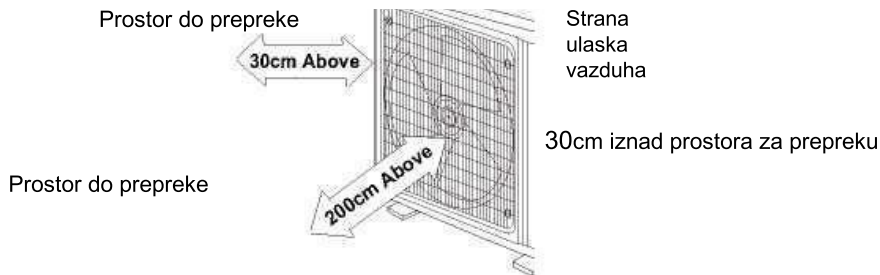

## Postavljanje spoljašnje jedinice

Dimenzije spoljašnje jedinice W1(W2)*H*D (mm)	A (mm)	B (mm)
665(710)x420x280	430	280
600(645)x485x260	400	290
660(710)x500x240	500	260
700(745)x500x255	460	260
730(780)x545x285	540	280
760(810)x545x285	540	280
790(840)x550x290	545	300
800(860)x545x315	545	315
800(850)x590(690)x310	540	325
825(880)x655x310	540	335
900(950)x700x350	630	350
900(950)x795x330	535	350

## Postavljanje creva za povezivanje

Povezivanje spoljašnje jedinice sa crevom za povezivanje:

Dužina creva	Koliko rashladnog sredstva dodati	
Do 5M	Nije potrebno	
5 - 15M	CC*12000Btu	20g/m
	CC*18000Btu	30g/m

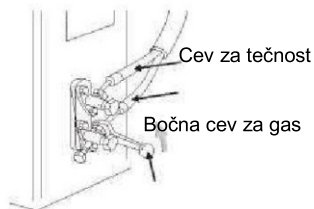

\* Povežite spoljne jedinice sa vezne cevi:

Ciljajte kontra-otvor na veznu cev za kraj ventila, i zategnite konus maticu sa prstima.

Zatim zategnite konus navrtanj sa ključem.

\* Kada produžavate cevi, tako da neće biti dovedeno u pitanje rad i učinak klima uređaja.

Ključ za maticu

# Postavljanje spoljašnje jedinice

## Povezivanje žica

1. Olabavite zavrtnje i uklonite poklopce iz jedinice.
2. Povežite kablove sa odgovarajućim terminalima spoljašnje jedinice (vidi dijagram povezivanja žica), a ako postoje signali vezani za utikač, samo ih ujedinite.
3. Uzemljenje žica: Uklonite vijak za uzemljenje iz električne konzole, pokrite kraj žice za uzemljenje na vijak i zavrnuti ga u uzemljenu rupu.
4. Fiksirajte kabl sa učvršćivačem.
5. Vratite poklopac u prvobitni položaj i pričvrstite ga zavrtnjima.

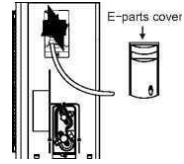

## Prikaz povezivanja žica

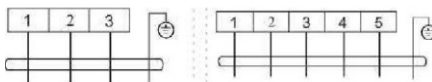
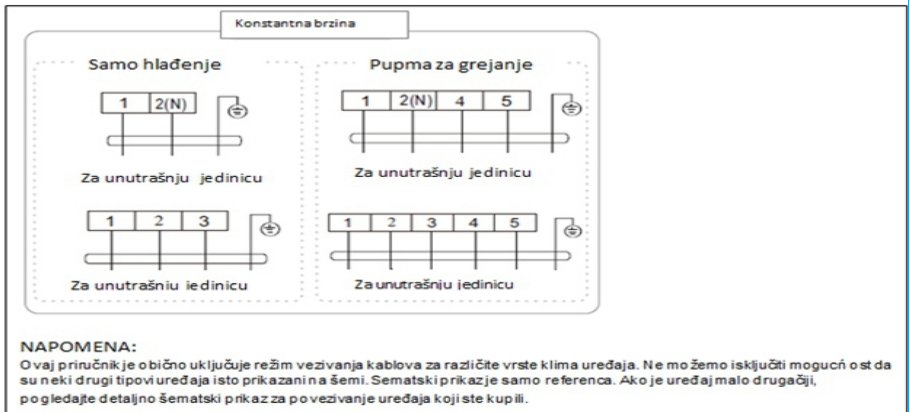

Za unutrašnju jedinicu

### Konektor

Ukoliko postoji konektor vežite direktno.

Za unutrašnju jedinicu

# Postavljanje spoljašnje jedinice

## Izbacivanje vazduha

### ★ Pražnjenje rashladnog sredstva kod spoljašnje jedinice

Nakon što ste povezali creva, nastavite kao što je prikazano.

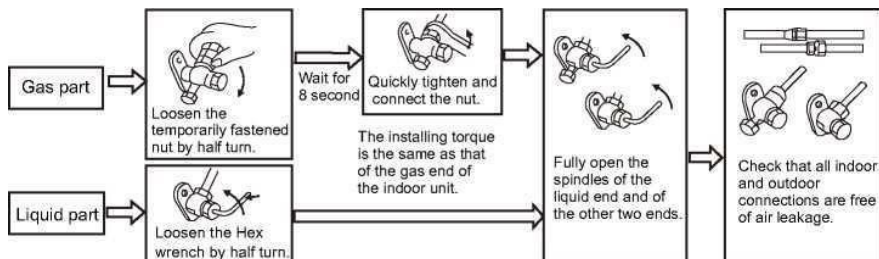

**Deo za gas:** Otpustite napola pričvršćen šraf. Sačekajte 8 sekundi. Brzo zategnite i povežite maticu. Potpuno otvorite ventile na kraju cevi i povežite dvostepenim ventilom. Proverite da na spoljašnjoj i unutrašnjoj jedinici nema ispuštanja vazduha.

**Deo za tečnost:** Otpustite šestougaonim odvijačem napola kao na slici. Potpuno otvorite ventile na kraju cevi i povežite dvostepenim ventilom. Proverite da na spoljašnjoj i unutrašnjoj jedinici nema ispuštanja vazduha.

NB: Okretni moment je isti kao i kod povezivanja cevi za gas.

### ★ Vazdušno čišćenje (evakuacija R410A rashladnog sredstva )

Pre svih radova na klima, skinite poklopac stop ventila (gas i tečnost ventili) i budite sigurni da ga pritegnite posle. (da bi se sprečilo potencijalno curenje vazduha)

1. Da bi se sprečilo curenje vazduha i prospanje zategnite matice kod svih cevi.
2. Povežite ventil, crevo za punjenje, glavni ventil i vakuum pumpu.
3. Potpuno otvorite ručicu i ostavite pumpu da radi najmanje 15 minuta i proverite da li su očitavanja multimetra  $-0.1\text{Mpa}$  ( $-76\text{cmHg}$ ).
4. Nakon nanošenja vakuuma, otvorite ventil heksagonalnim ključem.
5. Proverite da su i otvoreni i zatvoreni konektori su bez curenja.

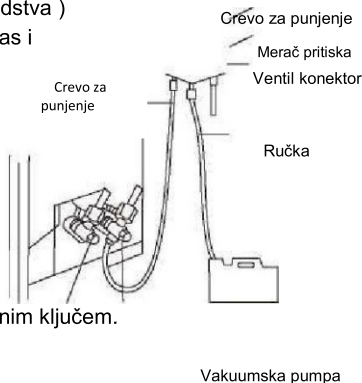

### Spoljni odvod kondenzata (samo za toplotne pumpe)

Za vreme grejanja, kondenzovana i odležana voda bi trebalo da se odvede crevom za odvod kondenzata. Povežite spoljni konektor za odvod kondenzata (otvor  $\Phi 25$ ) na osnovnoj ploči, i crevo za odvod kondenzata, tako da otpadna voda stvorena u Spoljnoj jedinici, može da se sprovede napolje.

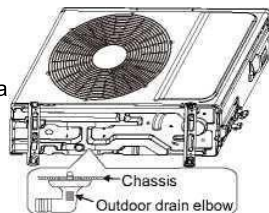

# Provera nakon postavljanja i test funkcionisanja

## Provera nakon postavljanja

### ★ Provera bezbednosni električn energije

1. Proveriti da li napon odgovara.
2. Proveriti da li postoji bilo kakva neispravna veza ili loše priključenje struje, signala i uzemljene žice.
3. Da li su uzemljene žice sigurno i pravilno uzemljene.

### ★ Provera bezbednosti instalacija

1. Da li je instalacija sigurna.
2. Da li voda glatko otiče.
3. Da li su žice i kablovi pravilno postavljeni.
4. Proveriti da slučajno neki deo nije ostao unutar jedinice.

### ★ Testiranje curenja rashladnog sredstva

U zavisnosti od načina instalacije, mogu se primeniti sledeći metodi za utvrđivanje i proveru u delovima kao što su 4 konekcije spoljašnje jedinice kao i jezgara odvodnih ventila i T-ventila:

1. Metod mehurića: Nanesite jednaki sloj spreja ili sapunice na sumnjivo mesto gde bi moglo curiti i pažljivo posmatrajte hoće li doći do mehurića.
2. Metod Instrument: Proveriti curenje dodirujući sondu detektora za curenje u skladu sa uputstvima o sumnjivim tačkama gde može doći do curenja.

## Test funkcionisanja

Prip rema za Test funkcionisanja

- Proverite da li su sve cevi i kablovi dobro povezani.
- Proverite da li su ventili na gasnoj i tečnoj strani potpuno otvoreni.
- Povežite napojni kabl sa utičnicom.
- Stavite baterije u daljinski upravljač.

Koraci testa funkcionisanja

1. Uključite klima uređaj i pritisnite dugme ON/OFF na daljinskom upravljaču da biste pokrenuli uređaj.
2. Izaberite Hlađenje, Grejanje (nije dostupno kod modela koji su samo za hlađenje), SWING i druge načine rada uz pomoć daljinskog upravljača da proverite da li je rad uređaja ispravan.



# Owner's Manual

Split type wall mounted  
air-conditioner

## Models

SFE09-AA  
SFE12-AA  
SFE18-AA  
SFE24-AA  
SFG12-SC  
SFG18-SC  
SFX09-IO  
SFX12-IO  
SFX18-IO  
SFX24-IO

- ※ Please read this owner's manual carefully and thoroughly before operating the unit!
- ※ Take care of this manual for future reference.

## CONTENTS

### Operation and maintenance

Safety Precautions .....	1
Notices for use .....	6
Names of each part .....	8
Clean and care .....	9
Troubleshooting .....	10

### Installation service

Notices for installation .....	12
Install indoor unit .....	15
Install outdoor unit .....	18
Check after installation and test operation .....	21

Note: All the pictures in this manual are just schematic diagrams,  
the actual is the standard.

## Safety Precautions

**Incorrect installation or operation by not following these instructions may cause harm or damage to people, properties, etc.**

**The seriousness is classified by the following indications:**

### **WARNING** ⚠

This symbol indicates the possibility of death or serious injury.

### **CAUTION** ⚠

This symbol indicates the possibility of injury or damage to properties.

### **WARNING** ⚠

**This appliance can be used by children aged from 8 years and above and persons with reduced physical, sensory or mental capabilities or lack of experience and knowledge if they have been given supervision or instruction concerning use of the appliance in a safe way and understand the hazards involved. Children shall not play with the appliance. Cleaning and user maintenance shall not be made by children without supervision.  
(Only for the AC with CE-MARKING)**

**This appliance is not intended for use by persons (including children) with reduced physical, sensory or mental capabilities, or lack of experience and knowledge, unless they have been given supervision or instruction concerning use of the appliance by a person responsible for their safety. Children should be supervised to ensure that they do not play with the appliance.  
(Except for the AC with CE-MARKING)**

### Safety precautions

**The air conditioner must be grounded. Incomplete grounding may result in electric shocks.**



Do not connect the earth wire to the gas pipeline, water pipeline, lightning rod, or telephone earth wire.

**Pull out the plug (or cut off the main power switch) when the unit is not in use for long time so as to ensure safety.**

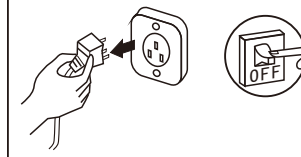

**Before the connector is plugged in, please make sure that there is no dust on it and that it is plugged fully in place.**



**If the power supply cord is damaged, it must be replaced by the manufacture or its service agent or a similar qualified person.**

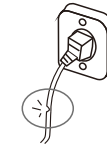

**Don't pull out the power plug during operating or with wet hands.**



It may cause electric shock or fire.

**Take care not let the remote control and the indoor unit watered or being too wet.**

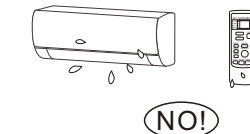

Otherwise, it may cause short circuit even fire.

**Always switch off the device and cut the power supply before performing any maintenance or cleaning.**



Otherwise, it may cause electric shock or damage.

**Don't pull the power cord when pull out the power plug.**

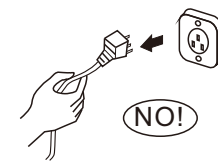

The damage of pulling power cord will cause serious electric shock.

**Don't share the socket with other electric appliance.**

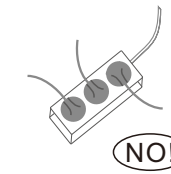

Otherwise, it may cause electric shock even fire.

## Safety Precautions

**Don't install air conditioner in a place where there is flammable gas or liquid. The distance between them should above 1m.**

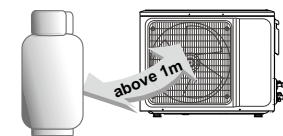

It may cause fire.

**Don't use liquid or corrosive cleaning agent wipe the air conditioner and sprinkle water or other liquid either.**

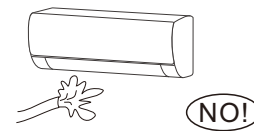

Doing this may cause electric shock or damage to the unit.

**Don't attempt to repair the air conditioner by yourself.**

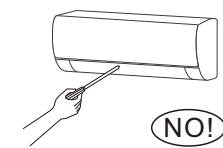

Incorrect repairs may cause electric or fire. Contact a qualified service technician for all service requirement.

**Don't use air conditioner in lightning storm weather.**

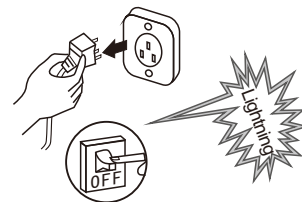

Power supply should be cut in time to prevent the occurrence of danger.

**Don't put hands or any objects into the air inlets or outlets.**

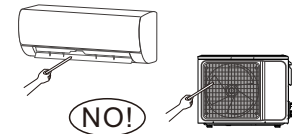

This may cause personal injury or damage to the unit.

**Please note whether the installed stand is firm enough or not.**

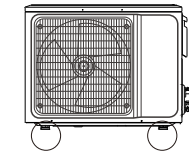

If it is damaged, it may lead to the fall of the unit and cause the injury.

**Don't block air inlet or air outlet.**

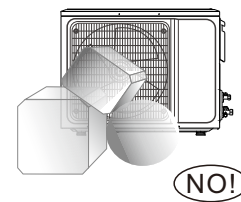

Otherwise, the cooling or heating capacity will be weakened, even cause system stop operating.

**Don't let the air conditioner blow against the heater appliance.**

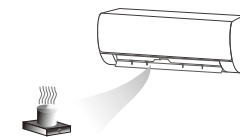

Otherwise it will lead to incomplete combustion, thus causing poisoning.

**An earth leakage breaker with rated capacity must be installed to avoid possible electric shocks.**

**The appliance shall be installed in accordance with national wiring regulations.**

## Safety Precautions

### **This product contains fluorinated greenhouse gases.**

Refrigerant leakage contributes to climate change. Refrigerant with lower global warming potential (GWP) would contribute less to global warming than a refrigerant with higher GWP, if leaked to the atmosphere. This appliance contains a refrigerant fluid with a GWP equal to [2088]. This means that if 1 kg of this refrigerant fluid would be leaked to the atmosphere, the impact on global warming would be [2088] times higher than 1 kg of CO<sub>2</sub>, over a period of 100 years. Never try to interfere with the refrigerant circuit yourself or disassemble the product yourself and always ask a professional.

### **WEEE Warning**

**Meaning of crossed out wheeled dustbin:**  
**Do not dispose of electrical appliances as unsorted municipal waste, use separate collection facilities.**

**Contact your local government for information regarding the collection systems available.**  
**If electrical appliances are disposed of in landfills or dumps, hazardous substances can leak into the groundwater and get into the food chain, damaging your health and well-being.**

**When replacing old appliances with new ones, the retailer is legally obligated to take back your old appliance for disposals at least free of charge.**



## Safety Precautions

### CAUTION

**Don't open the windows and doors for long time when the air conditioner is running.**

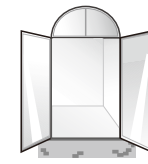

Otherwise, the cooling or heating capacity will be weakened.

**Don't stand on the top of the outdoor unit or place heavy things on it.**

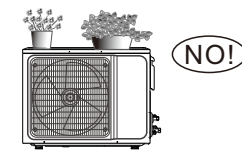

This could cause personal injuries or damage the unit.

**Don't use the air conditioner for other purposes, such as drying clothes, preserving foods, etc.**

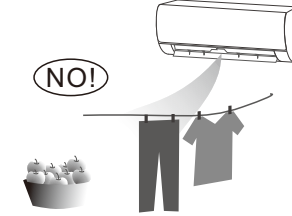

**Don't apply the cold air to the body for a long time.**

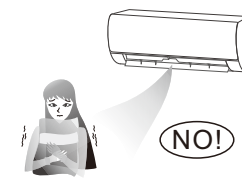

It will deteriorate your physical conditions and cause health problems.

**Set the suitable temperature.**

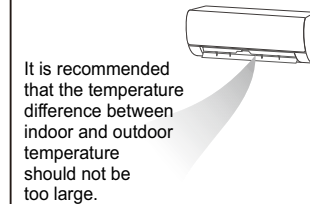

It is recommended that the temperature difference between indoor and outdoor temperature should not be too large.

Appropriate adjustments of the setting temperature can prevent the waste of electricity.

**If your air conditioner is not fitted with a supply cord and a plug, an all-pole switch must be installed in the fixed wiring and the distance between contacts should be no less than 3.0 mm.**

**If your air conditioner is permanently connected to the fixed wiring, a residual current device (RCD) having rated residual operating current not exceeding 30 mA should be installed in the fixed wiring.**

**The power supply circuit should have leakage protector and air switch of which the capacity should be more than 1.5 times of the maximum current.**

**Regarding the installation of the air conditioners, please refer to the below paragraphs in this manual.**

## Notices for use

### The conditions of unit can't normally run

\* Within the temperature range provided in following table, the air conditioner may stop running and other anomalies may arise.

Cooling	Outdoor	>43°C(Apply to T1)
	Indoor	>52°C(Apply to T3)
Heating	Outdoor	<18°C
	Indoor	>24°C <-7°C >27°C

\* When the temperature is too high, the air conditioner may activate the automatic protection device, so that the air conditioner could be shut down.

\* When the temperature is too low, the heat exchanger of the air conditioner may freeze, leading to water leakage or other malfunction.

\* In long-term cooling or dehumidification with a relative humidity of above 80% (doors and windows are open), there may be water condenses or dripping near the air outlet.

\* T1 and T3 refer to ISO 5151.

### Notes for heating

\* The fan of the indoor unit will not start running immediately after the heating is started to avoid blowing out cool air.

\* When it is cold and wet outside, the outdoor unit will develop frost over the heat exchanger which will compromise the heating capacity. This is when the air conditioner will start defrost.

\* During defrost, the air conditioner will stop heating for about 5-12 minutes.

\* Vapor may come out from the outdoor unit during defrost. This is not a malfunction, but a result of fast defrost.

\* Heating will resume after defrost is complete.

### Notes for turning off

\* When the air conditioner is turned off, the main controller will automatically decide whether to stop immediately or after running for dozens of seconds with lower frequency and lower air speed.





### Names of each part

#### Indoor unit

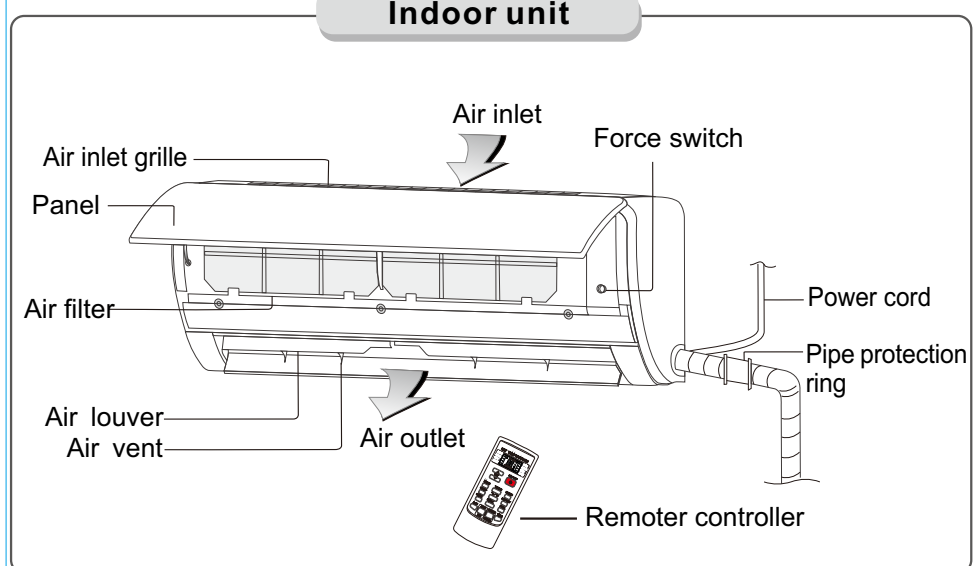

#### Outdoor unit

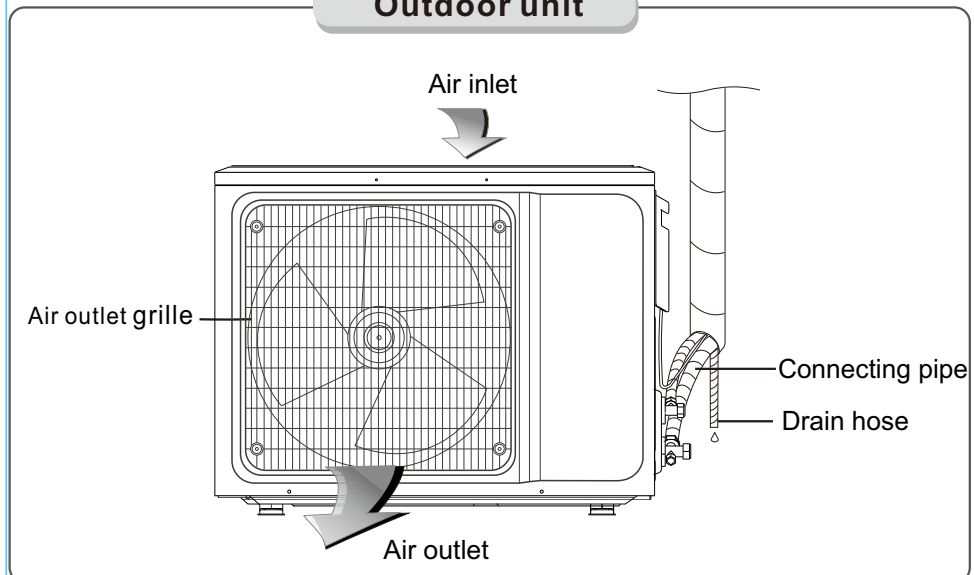

**Note: All the pictures in this manual are just schematic diagrams, the actual is the standard.**

## Clean and care

### Warning

- Before the cleaning of the air conditioner, it must be shut down and the electricity must be cut off for more than 5 minutes, otherwise there might be the risk of electric shocks.
- Do not wet the air conditioner, which can cause an electric shock. Make sure not to rinse the air conditioner with water under any circumstances.
- Volatile liquids such as thinner or gasoline will damage the air conditioner housing, therefore please clean the housing of air conditioner only with soft dry cloth and damp cloth moistened with neutral detergent.
- In the course of the using, pay attention to cleaning the filter regularly, to prevent the covering of dust which may affect the effect. If the service environment of the air conditioner is dusty, correspondingly increase the number of times of cleaning. After removing the filter, do not touch the fin part of the indoor unit with the finger, so as to avoid scratching it.

### Clean the panel

When the panel of the indoor unit is contaminated, clean it gently with a wrung towel using tepid water below 45°C, and do not remove the panel while cleaning.

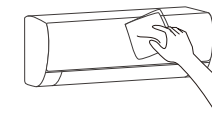

### Clean the air filter

#### ■ Remove the air filter



1. Use both hands to open the panel for an angle from both ends of the panel in accordance with the direction of the arrow.
2. Release the air filter from the slot and remove it.

#### ■ Clean the Air Filter

Use a vacuum cleaner or water to rinse filter, and if the filter is very dirty (for example, with greasy dirt), clean it with warm water (below 45°C) with mild detergent dissolved in, and then put the filter in the shade to dry in the air.

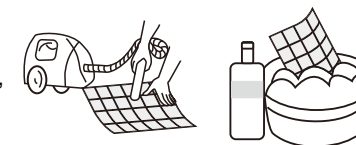

## Clean and care

### Clean the air filter

#### ■ Mount the Filter

1. Reinstall the dried filter in reverse order of removal, then cover and lock the panel.

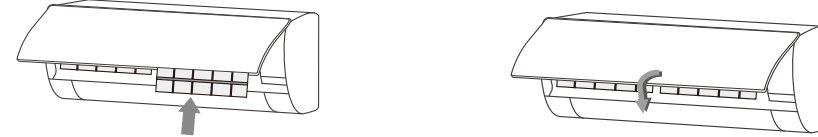

### Check before use

1. Check whether all the air inlets and outlets of the units are unblocked.
2. Check whether there is blocking in the water outlet of the drain pipe, and immediately clean it up if any.
3. Check the ground wire is reliably grounded.
4. Check whether the remote control batteries are installed, and whether the power is sufficient.
5. Check whether there is damage in the mounting bracket of the outdoor unit, and if any, please contact our local service center.

### Maintain after use

1. Cut off the power source of the air conditioner, turn off the circuit breaker and remove the batteries from the remote control.
2. Clean the filter and the unit body.
3. Remove the dust and debris from the outdoor unit.
4. Check whether there is damage in the mounting bracket of the outdoor unit, and if any, please contact our local service center.

## Troubleshooting

### ⚠ Caution

\* Do not repair the air conditioner by yourself as wrong maintenance may cause electric shock or fire, please contact the authorized service center and let the professionals conduct the maintenance, and checking the following items prior to contacting for maintenance can save your time and money.

## Troubleshooting

Phenomenon	Troubleshooting
Air conditioner can not operate at all.	<ul style="list-style-type: none"> <li>• Has the power been shut down?</li> <li>• Is the wiring loose?</li> <li>• Is voltage too high or too low?(measured by professionals)</li> <li>• Does it reach the set time for start up?</li> <li>• Does the circuit protection device trip?</li> </ul>
Remote controller is not available.	<ul style="list-style-type: none"> <li>• Is the remote controller out of effective distance to the indoor unit?</li> <li>• Are there any obstructions between the controller and the signal receptor?</li> <li>• Is the battery exhausted?</li> </ul>
Cooling (Heating) efficiency is not good.	<ul style="list-style-type: none"> <li>• Is the setting temperature suitable?</li> <li>• Are air filter dirty?</li> <li>• Is the air inlet or outlet obstructed?</li> <li>• Is indoor fan speed set at low speed?</li> <li>• Is there any heat source in your room?</li> </ul>
Indoor unit does not operate immediately when the air conditioner is restarted.	If the air conditioner is turned on immediately after it is turned off, the protective delay switch will delay the operation for 3 to 5 minutes.
There is unusual smell blowing from the outlet after operation is started.	The air conditioner itself does not have undesirable odor. If there is odor, it may be due to accumulation of the odor in the environment. Please clean the air filter or activate the cleaning function.
There is sound of running water during the running of air conditioner.	Sometimes the "hissing" sound of running water can be heard. This is the sound of the flow of the refrigerant, not a malfunction.
A slight "click" sound is heard at the of start-up or shut-down.	Due to temperature changes, panel and other parts will swell, causing the sound of friction. This is normal, not a fault.
During the cooling operation, the indoor unit outlet sometimes will blow out mist.	This is because the indoor air is cooled rapidly. After it runs for some time, the indoor temperature and humidity will be reduced and the mist will disappear.
<p><b>⚠ Immediately stop all operations and cut off the power supply , contact our Service center locally in following situations.</b></p> <ul style="list-style-type: none"> <li>▲ Shriill sound is heard or Unpleasant odor is emitted during the operation.</li> <li>▲ There is an abnormal heat in power supply cord and power plug.</li> <li>▲ Accidentally pour impurities or water into the machine or the remote control.</li> <li>▲ Air switch or protection switch often breaks.</li> </ul>	

## Notices for installation

### ⓘ Important Notices

- Before installing, please contact with local authorized maintenance center, if unit is not installed by the authorized maintenance center, the malfunction may not solved, due to discommodious contact.
- The air conditioner must be installed by professionals according to the national wiring rules and this manual.
- To move and install air conditioner to another place, please contact our local special service center.

### Requirements For Installation Position

- Avoid places of inflammable or explosive gas leakage or where there are strongly aggressive gases.
- Avoid places subject to strong artificial electric/magnetic fields.
- Avoid places subject to noise and resonance.
- Avoid severe natural conditions (e.g. heavy lampblack, strong sandy wind, direct sunshine or high temperature heat sources).
- Avoid places within the reach of children.
- Shorten the connection between the indoor and outdoor units.
- Select where it is easy to perform service and repair and where the ventilation good.
- The outdoor unit shall not be installed in any way that could occupy an aisle, stairway, exit, fire escape, catwalk or any other public area.
- The outdoor unit shall be installed as far as possible from the doors and windows of the neighbors as well as the green plants.

### Requirements for operations at raised height

- When carrying out installation at 2m or higher above the base level, safety belts must be worn and ropes of sufficient strength be securely fasten to the outdoor unit, to prevent falling that could cause personal injury or death as well as property loss.

## Notices for installation

### Requirements of the mounting structure

- The mounting rack must meet the relevant national or industrial standards in terms of strength with welding and connection areas rustproofed.
- The mounting rack and its load carry surface shall be able to withstand 4 times or above the weight of the unit, or 200kg, whichever is heavier.
- The mounting rack of the outdoor unit shall be fastened with expansion bolt.
- Ensure the secure installation regardless of what type of wall on which it is installed, to prevent potential dropping that could hurt people.

### Electrical Safety Requirements

- Be sure to use the rated voltage and air conditioners dedicated circuit for the power supply, and the power cord diameter must meet the national requirements.
- When the maximum current of air conditioner is  $\geq 16A$ , it must use the air switch or leakage protection switch equipped with protection devices.
- The normal operating range is 90%-110% of the local rated voltage.
- The minimum clearance between the air conditioner and the combustibles is 1.5 m.

### Grounding Requirements

- The air conditioner is the type I electrical appliance and must ensure a reliable grounding.
- Do not connect the grounding wire to a gas pipe, water pipe, lightning rod, telephone line, or a circuit poorly grounded to the earth.
- The grounding wire is specially designed and shall not be used for other purpose, nor shall it be fastened with a common tapping screw.

## Notices for installation

### Others

- The connection method of the air conditioner and the power cord and the interconnection method of each independent element shall be subject to the wiring diagram affixed to the machine.
- The model and rating value of the fuse shall be subject to the silkscreen on corresponding controller or fuse sleeve.

### Packing list

#### Packing list of the indoor unit

N0.	Name	Quantity	Unit
1	Indoor Unit	1	Set
2	Remote Controller	1	PC
3	Batteries (7#)	2	PC
4	Instructions	1	Set
5	Drain pipe	1	PC

#### Packing list of the outdoor unit

N0.	Name	Quantity	Unit
1	Outdoor Unit	1	Set
2	Connecting pipe	2	PC
3	Plastic Strap	1	ROLL
4	Pipe Protection Ring	1	PC
5	Luting (putty)	1	PACKET

NOTE: All accessories shall be subject to actual packaging material, and if there is any difference, please understand.



## Install indoor unit

### Dimension drawing of indoor unit installation

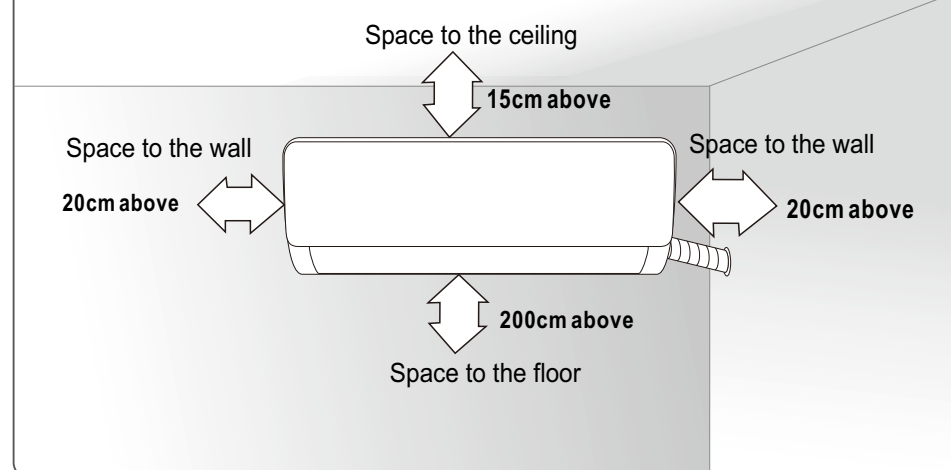

### Mounting plate

1. The wall for installation of the indoor unit shall be hard and firm, so as to prevent vibration.
2. Use the "+" type screw to fasten the peg board, horizontally mount the peg board on the wall, and ensure the lateral horizontal and longitudinal vertical.
3. Pull the peg board by hand after the installation, to confirm whether it is solid.

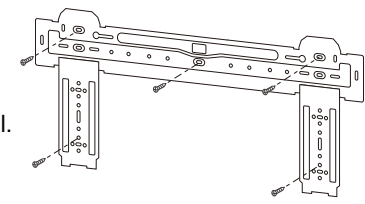

### Wall-through Hole

1. Make a hole with an electric hammer or a water drill at the predetermined position on the wall for piping, which shall slant outwardly by 5°-10°.
2. To protect the piping and the cables from being damaged running through the wall, and from the rodents that may inhabit in the hollow wall, a pipe protecting ring shall be installed and sealed with putty.

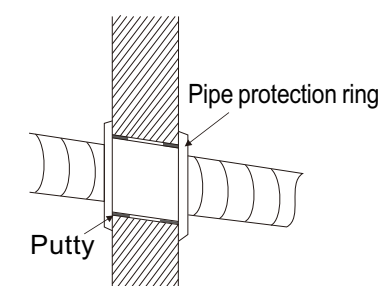

**Note:** Usually, the wall hole is  $\Phi 60\text{mm} \sim \Phi 80\text{mm}$ . Avoid pre-buried power wire and hard wall when making the hole.

## Install indoor unit

### Route of Pipeline

- Depending on the position of the unit, the piping may be routed sideway from the left or the right ( Fig 1 ), or vertically from the back( Fig 2 )(depending on the pipe length of the indoor unit). In the case of sideway routing, cut off the outlet cutting stock of the opposite side.
- The power cord may be routed separately from the piping. Cut off the outlet cutting stock and then run the power cord through the hole, keeping the remaining part as a protection from rodents.

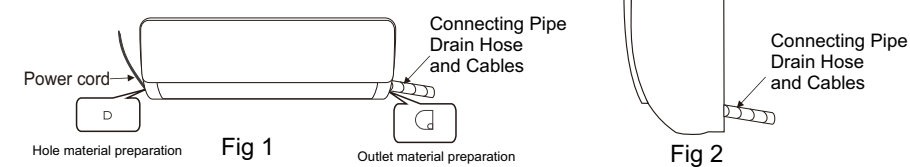

### Drain pipe connection

- Remove the mountings and pull the indoor unit pipe out of the housing.
- Connect the connecting pipe to the indoor unit:  
Aim at the pipe center, tighten the Taper nut with fingers, and then tighten the Taper nut with a torque wrench, and the direction is shown in diagram on the right. The torque used is shown in the following table.

Tightening torque table

The size of pipe(mm)	Torque(N · m)
Φ6/Φ6.35	1.5~2.5
Φ9.52	3.5~4.0
Φ12/Φ12.7	4.5~6.0
Φ15.88	7.3~7.8
Φ19.05	7.5~8.0

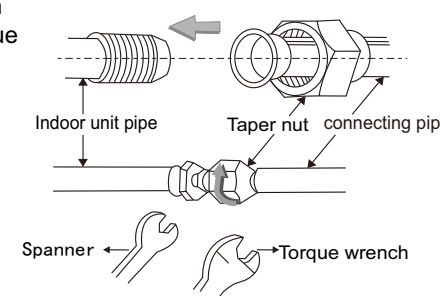

### Wrap the Piping

- Use the insulation sleeve to wrap the joint part the indoor unit and the connection pipe, and then use insulating material to pack and seal insulation pipe, to prevent generation of condensate water on the joint part.
- Connect the water outlet with drain pipes, and make the connection pipe, cables, and the drain hose straight.
- Use plastic cable ties to wrap the connecting pipes, cables and drain hose. Run the pipe sloping downward.

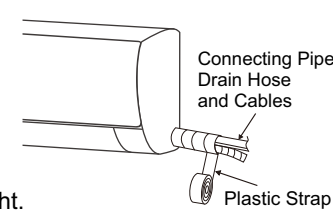

## Install Indoor Unit

### Fixing the Indoor Unit

1. Hang the indoor unit on the peg board, and move the unit from left to right to ensure that the hook is properly positioned in the peg board.
2. Push toward the lower left side and the upper right side of the unit toward the peg board, until the hook is embedded in the slot and makes a "click" sound.

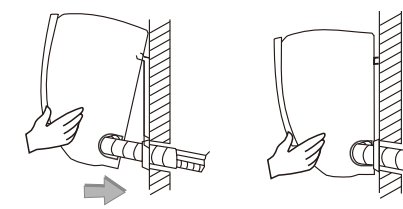

### Wiring diagram

- If your air conditioner is provided with power cable, the wiring of the indoor unit is connected in the factory, there is no need of connection.
- If the power cable is not provided, connection is needed in accordance with the wiring diagram.

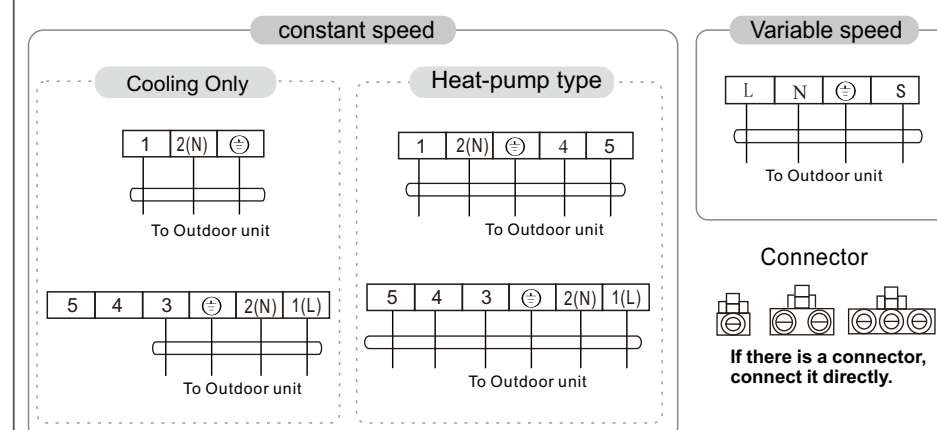

#### NOTE:

- ※ This manual is usually includes the wiring mode for the different kind of A/C. We cannot exclude the possibility that some special type of wiring diagrams are not included.
- ※ The diagram are for reference only. If the entity is difference with this wiring diagram, please refer to the detailed wiring diagram adhered on the unit which you purchased.

## Install outdoor unit

### Dimension drawing of outdoor unit installation

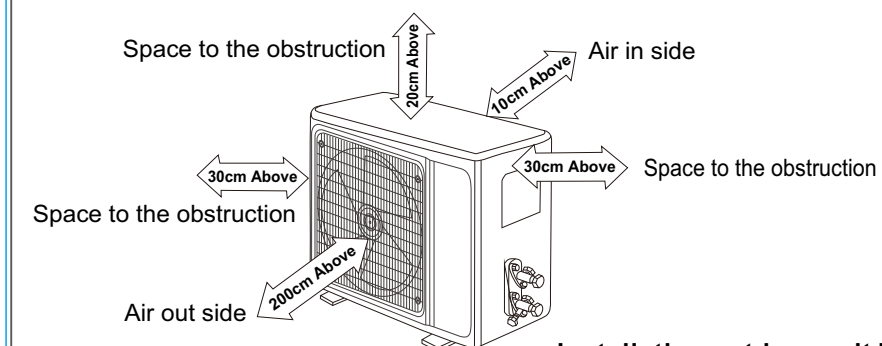

### Installation outdoor unit bolt

Outdoor Unit Size of Shape W1(W2)*H*D (mm)	A (mm)	B (mm)
665(710)×420×280	430	280
600(645)×485×260	400	290
660(710)×500×240	500	260
700(745)×500×255	460	260
730(780)×545×285	540	280
760(810)×545×285	540	280
790(840)×550×290	545	300
800(860)×545×315	545	315
800(850)×590(690)×310	540	325
825(880)×655×310	540	335
900(950)×700×350	630	350
900(950)×795×330	535	350

### Install the connection pipe

Connect the Outdoor Unit with Connecting Pipe:  
Aim the counter-bore of the connecting pipe at the stop valve, and tighten the Taper nut with fingers. Then tighten the Taper nut with a torque wrench.

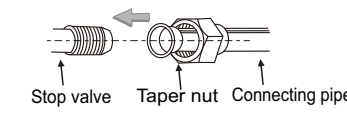

★ When prolonging the piping, extra amount of refrigerant must be added so that the operation and performance of the air conditioner will not be compromised.

Piping length	Amount of refrigerant to be added
≤5M	Not needed
5-15M	CC≤12000Btu 20g/m
	CC≥18000Btu 30g/m

Note: This table is for reference only.

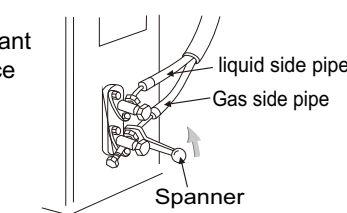

## Install outdoor unit

### Wiring Connection

1. Loosen the screws and remove E-parts cover from the unit.
2. Connect the cables respectively to the corresponding terminals of the terminal board of the outdoor unit (see the wiring diagram), and if there are signals connected to the plug, just conduct butt joint.
3. Ground wire: Remove the grounding screw out of the electric bracket, cover the grounding wire end onto the grounding screw and screw it into the grounding hole.
4. Fix the cable reliably with fasteners (Pressing board).
5. Put the E-parts cover back in its original place and fasten it with screws.

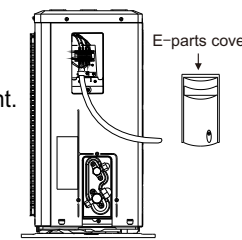

### Wiring diagram

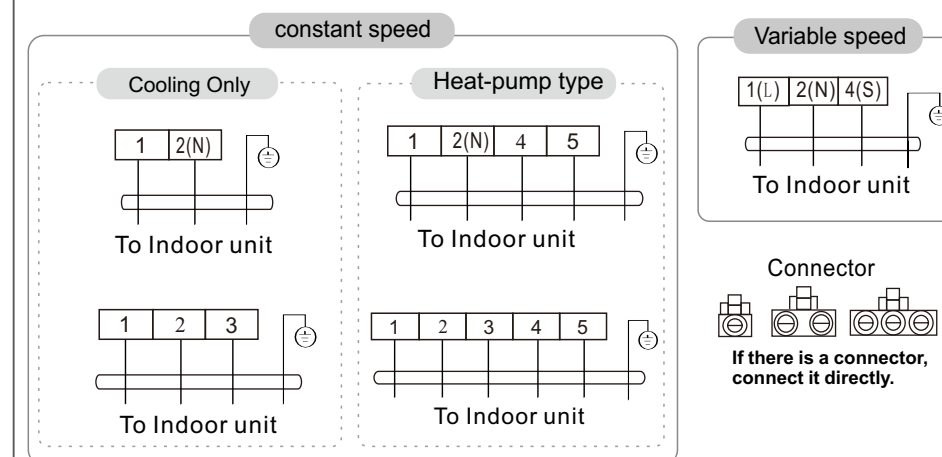

**NOTE:**

- ※ This manual is usually includes the wiring mode for the different kind of A/C. We cannot exclude the possibility that some special type of wiring diagrams are not included.
- ※ The diagram are for reference only. If the entity is difference with this wiring diagram, please refer to the detailed wiring diagram adhered on the unit which you purchased.

## Install outdoor unit

### Expelling the air

#### ★Outdoor unit refrigerant discharging method

After the pipe side connection is complete, proceed as follows.

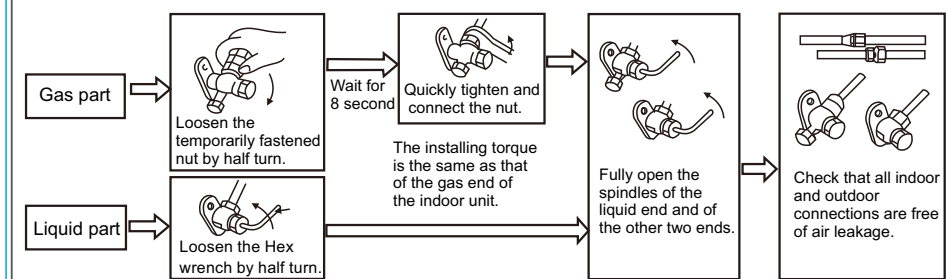

#### ★Vacuum Pumping Method (R410A refrigerant evacuation must use the vacuum pumping method)

Before working on the air conditioner, remove the cover of the stop valve(gas and liquid valves)and be sure to retighten it afterward.(to prevent the potential air leakage)

1. To prevent air leakage and spilling tighten all connecting nut of all flare tubes.
2. Connect the stop valve, charge hose, manifold valve, and vacuum pump.
3. Fully open the handle Lo of the manifold valve and apply vacuum for at least 15 minutes and check that the compound vacuum gauge reads -0.1MPa(-76cmHg).
4. After applying vacuum, fully open the stop valve with a hex wrench.
5. Check that both indoor and outdoor connections are free of air leakage.

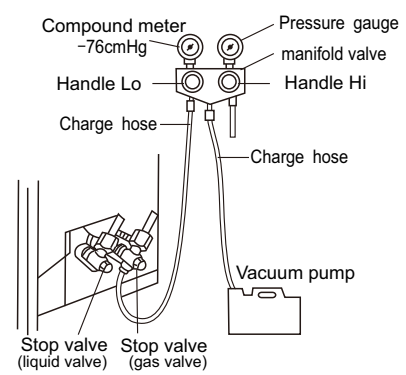

### Outdoor condensation drainage(Heat pump type only)

When the unit is heating, the condensing water and defrosting water can be out reliably through the drain house.

#### Installation:

Install the outdoor drain elbow in  $\Phi 25$  hole on the base plate, and joint the drain hose to the elbow, so that the waste water formed in the outdoor unit can be drained out to a proper plate.

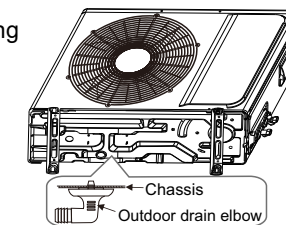

## Check after installation and test operation

### Check after installation

#### ★ Electrical Safety Check

1. If the supply voltage is as required.
2. If there is any faulty or miss connection in each of the power, signal and grounding wires.
3. If the grounding wire of the air conditioner is securely grounded.

#### ★ Installation Safety Check

1. If the installation is secure.
2. If the water drain is smooth.
3. If the wiring and piping are correctly installed.
4. Check that no foreign matter or tools are left inside the unit.

#### ★ Leak test of the refrigerant

Depending on the installation method, the following methods may be used to check for suspect leak, on areas such as the four connections of the outdoor unit and the cores of the cut-off valves and t-valves:

1. Bubble method: Apply of spray a uniform layer of soap water over the suspected leak spot and observe carefully for bubble.
2. Instrument method: Checking for leak by pointing the probe of the leak detector according to the instruction to the suspect points of leak.

### Test Operation

#### Test Operation preparation

- ※Verify that all piping and connection cables are well connected.
- ※Confirm that the valves at the gas side the liquid-side are fully open.
- ※Connect the power cord to an independent power socket.
- ※Install batteries in remote control.

#### Test Operation method

1. Turn on the power and push the ON/OFF switch button of the remote controller to start the air conditioner.
2. Select COOL, HEAT (not available on cool-only models), SWING and other operation modes with the remote controller and see if the operation is ok.





Ovaj dokument je originalno proizveden i objavljen od strane proizvođača, brenda Vox, i preuzet je sa njihove zvanične stranice. S obzirom na ovu činjenicu, Tehnoteka ističe da ne preuzima odgovornost za tačnost, celovitost ili pouzdanost informacija, podataka, mišljenja, saveta ili izjava sadržanih u ovom dokumentu.

Napominjemo da Tehnoteka nema ovlašćenje da izvrši bilo kakve izmene ili dopune na ovom dokumentu, stoga nismo odgovorni za eventualne greške, propuste ili netačnosti koje se mogu naći unutar njega. Tehnoteka ne odgovara za štetu nanесenu korisnicima pri upotrebi netačnih podataka. Ukoliko imate dodatna pitanja o proizvodu, ljubazno vas molimo da kontaktirate direktno proizvođača kako biste dobili sve detaljne informacije.

Za najnovije informacije o ceni, dostupnim akcijama i tehničkim karakteristikama proizvoda koji se pominje u ovom dokumentu, molimo posetite našu stranicu klikom na sledeći link:

<https://tehnoteka.rs/p/vox-klima-sfe18-aa-akcija-cena/>