

## Uputstvo za upotrebu

TEFAL parna stanica SV7111

**Tefal**<sup>®</sup>



Tehnoteka je online destinacija za upoređivanje cena i karakteristika bele tehnike, potrošačke elektronike i IT uređaja kod trgovinskih lanaca i internet prodavnica u Srbiji. Naša stranica vam omogućava da istražite najnovije informacije, detaljne karakteristike i konkurentne cene proizvoda.

Posetite nas i uživajte u ekskluzivnom iskustvu pametne kupovine klikom na link:

<https://tehnoteka.rs/p/tefal-parna-stanica-sv7111-akcija-cena/>

**FR** Veuillez lire attentivement le livret "Consignes de sécurité et d'utilisation" avant la première utilisation / **EN** Please read carefully the "Safety and use instructions" booklet before first use / **DE** Lesen Sie vor dem erstmaligen Gebrauch aufmerksam die Broschüre „Sicherheits- und Bedienungshinweise“ durch. / **NL** Gelieve vóór het eerste gebruik aandachtig het boekje met de veiligheids- en gebruiksvorschriften door te nemen / **ES** Lea detenidamente el libro «Instrucciones de seguridad y de uso» antes de utilizar el aparato por primera vez / **PT** Leia atentamente o manual «Instruções de segurança e utilização» antes da primeira utilização / **IT** Leggere con attenzione il libretto "Norme di sicurezza e d'uso" al primo utilizzo / **DA** Læs hæftet "Sikkerheds- og brugsanvisning" grundigt igennem inden den første ibrugtagning. / **NO** Les nøye heftet "Råd om sikkerhet og bruk" før første gangs bruk / **SV** Var god läs häftet "Säkerhets- och användningsinstruktioner" innan den första användningen. / **FI** Lue turvallisuu- ja käyttöohjevihko huolellisesti ennen ensimmäistä käyttökertaa. / **TR** İlk kullanımdan önce "Güvenlik ve kullanım talimatları" kitapçığını dikkatlice okuyun / **EL** Διαβάστε προσεκτικά το εγχειρίδιο «Οδηγίες ασφαλείας και χρήσης» πριν από την πρώτη χρήση / **PL** Przed pierwszym użyciem proszę uważnie przeczytać broszurę „Zalecenia dotyczące bezpieczeństwa i użytkowania” / **CS** Před prvním použitím si, prosím, pečlivě prostudujte „Bezpečnostní pokyny pro použití” / **SK** Pred prvým použitím si pozorne prečítajte „Bezpečnostné odporúčania a použitie”. / **HU** Az első használat előtt figyelmesen olvassa el a „Biztonsági előírások és használati útmutató” című fejezetet / **SL** Pred prvo uporabo natančno preberite »Navodila za varno uporabo« / **RU** Перед первым использованием внимательно прочитайте инструкцию «Меры безопасности и правила использования». / **UK** Перед першим використанням уважно прочитайте посібник «Правила техніки безпеки та рекомендації щодо використання» / **HR** Molimo da prije prve uporabe pažljivo pročitate priručnik „Sigurnosne upute” / **RO** Înainte de prima utilizare, citiți cu atenție manualul „Instrucțiuni de siguranță și de utilizare” / **ET** Palun lugege enne esimest korda kasutamist hoolikalt ohutus- ja kasutusjuhendit / **LT** Atidžiai perskaitykite knygelę „Saugos ir naudojimo reikalavimai” prieš naudodami įrenginį pirmą kartą / **LV** Pirms izmantotaj ierīci pirmoreiz, lūdzu rūpīgi izlasiet brošūru "Norādījumi par drošību un lietošanu" / **BG** Моля, прочетете внимателно книжката "Препоръки за безопасност и употреба" преди първоначална употреба / **SR** Molimo da pre prve upotrebe pažljivo pročitate knjžicu «Uputstva za bezbednost i upotrebu» / **BS** Molimo da prije prve upotrebe pažljivo pročitate knjžicu «Upute za sigurnost i upotrebu» / **FA** لطفاً دفترچه « دستورالعملهای ایمنی و کاربری » را قبل از اولین کاربری، با دقت بخوانید. / **AR** يرجى قراءة كتيب السلامة وإرشادات الاستعمال بعناية قبل الاستعمال للمرة الأولى / **TH** กรุณาอ่านหนังสือ "คู่มือความปลอดภัยและการใช้งาน" ก่อนการใช้งานครั้งแรก / **ZH** 在第一次使用前请认真阅读此“安全操作规程”手册

Утюги электрические с пароувлажителем торговой марки «TEFAL», модели: SV7110xx, SV7111xx, SV7112xx, SV7120xx, где x – любая цифра от 0 до 9 и/или буква от A до Z, определяющие страну назначения

Изготовлено в Китае для холдинга "GROUPE SEB", France (Groupe SEB, 112 Chemin du Moulin Carron 69130 Ecully, France)  
 Групп SEB, 112 Шмэн дю Мулен Каррон 69130 Экулю Франс  
 Официальный представитель, импортёр - ЗАО "Группа СЕБ-Восток"  
 125171, г. Москва, Ленинградское ш., д. 16А, стр. 3, помещение XII, тел. 8 (495) 213-32-32

Технические характеристики:  
 220-240 В 50-60 Гц 2380-2830 Ватт Класс I

Информация о сертификации:  
 • Сертификат соответствия №ЕАЭС RU C-FR.AГ27.B.00108/19  
 • Срок действия с 25.06.2019 по 24.06.2024  
 • Выдан ОС ООО «ИНТЕРСТАНДАРТ»

Соответствуют требованиям:  
 • ТР ТС 004/2011 «О безопасности низковольтного оборудования», утв. Решением КТС от 16.08.2011 г. №768.  
 • ТР ТС 020/2011 «Электромагнитная совместимость технических средств», утв. Решением КТС от 09.12.2011 г. №879.

Срок службы изделия 2 года с даты продажи в условиях эксплуатации и хранения при температуре от 0°C до 40 °C

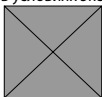

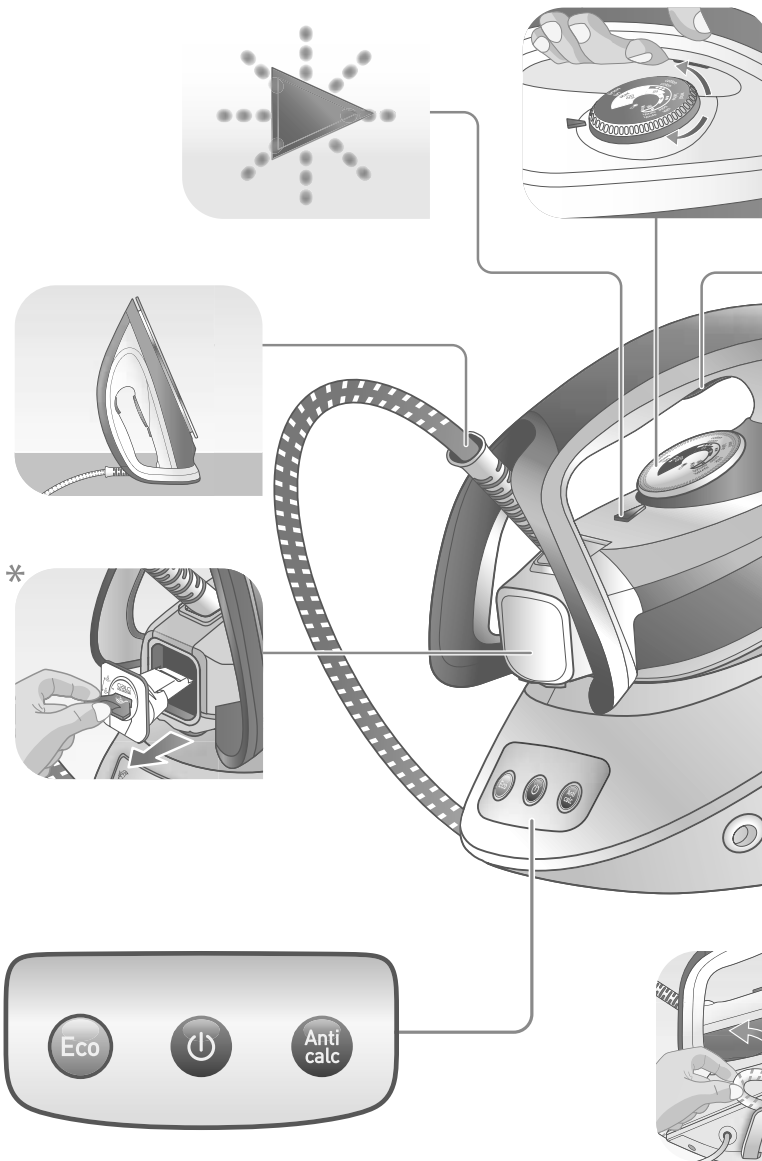

\* **FR** Selon modèle / **EN** Depending on model / **DE** Je nach Modell / **NL** Afhankelijk van het model / **ES** Según el modelo / **IT** Secondo i modelli / **DA** Afhængig af model / **NO** Avhenger av modell / **SV** Beroende på modell / **FI** Mallista riippuen mallista / **PL** W zależności od typu / **CS** Podle modelu / **SK** V závislosti od modelu / **HU** Modelltől függően / **SL** Ovisno o modelu / **UK** Залежно від моделі / **HR** Ovisno o modelu / **RO** Ovisno o modelu / **ET** Sõltuvalt mudelist / **LT** Ovisno o modelu / **BG** в зависимост от модела / **SR** U zavisnosti od modela / **BS** Ovisno o modelu / **FA** بر حسب مدل / **AR** ب حسب النموذج

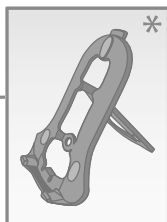
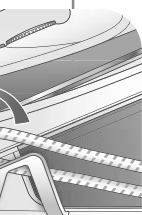
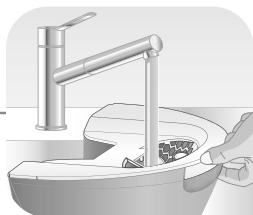
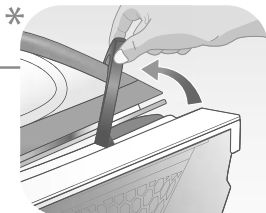
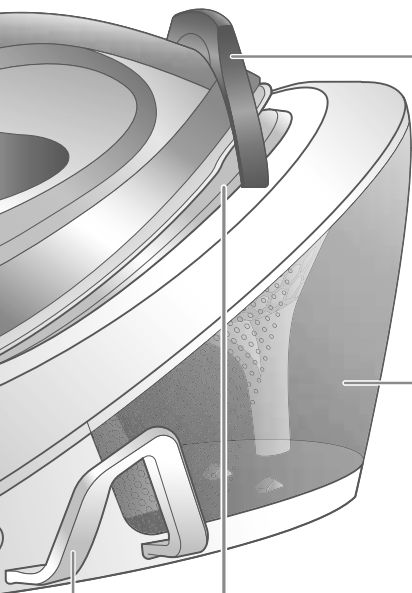
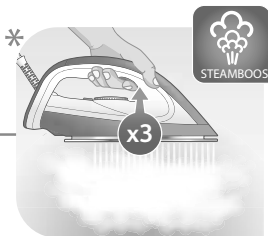

n modelo / **PT** Consoante o modelo /  
 puen / **TR** Modelle göre / **EL** ανάλογα με  
 odvisno od modela / **RU** В зависимости  
 Pagal modelį / **LV** Atbilstoši modelim /  
 حسب / **TH** ตามรุ่น / **ZH** 视型号而定

[www.tefal.com](http://www.tefal.com)



[www.calor.fr](http://www.calor.fr)





1.



[www.tefal.com](http://www.tefal.com)



[www.calor.fr](http://www.calor.fr)



\*

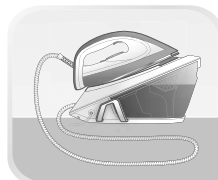
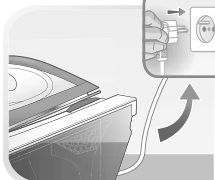
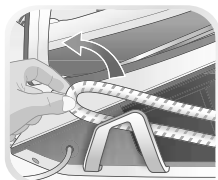
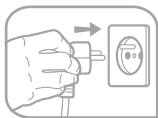
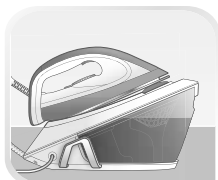
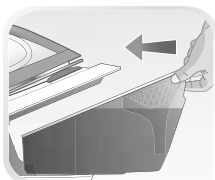
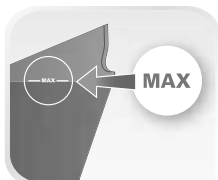
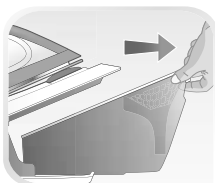
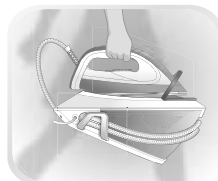
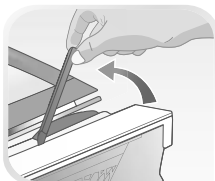
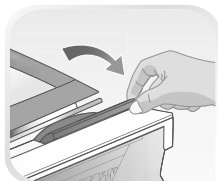

2.

[www.tefal.com](http://www.tefal.com)



[www.calor.fr](http://www.calor.fr)



ON

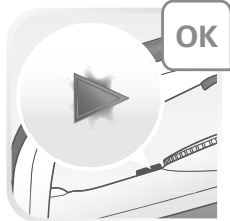
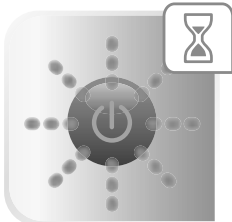
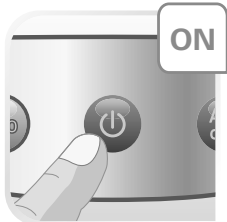

ECO



2.

[www.tefal.com](http://www.tefal.com)



[www.calor.fr](http://www.calor.fr)

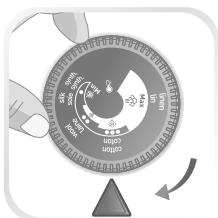
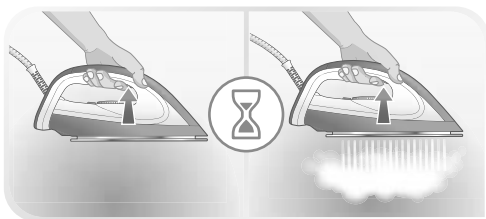



2.



[www.tefal.com](http://www.tefal.com)



[www.calor.fr](http://www.calor.fr)

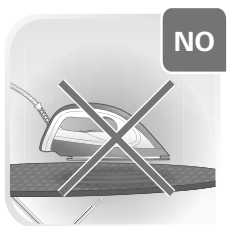
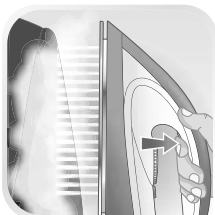
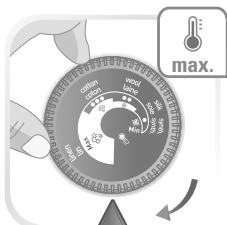

\* \* FR Selon modèle / EN Depending on model / DE Je nach Modell / NL Afhankelijk van het model / ES Según modelo / PT Consoante o modelo / IT Secondo i modelli / DA Afhængig af model / NO Avhenger av modell / SV Beroende på modell / FI Mallista riippuen / TR Modele göre / EL ανάλογα με το μοντέλο / PL W zależności od typu / CS Podle modelu / SK V závislosti od modelu / HU Modelltől függően / SL Odvisno od modela / RU В зависимости от модели / UK Залежно від моделі / HR Ovisno o modelu / RO Ovisno o modelu / ET Sõltuvalt mudelist / LT Pagal modelį / LV Atbilstoši modelim / BG В зависимост от модела / SR U zavisnosti od modela / BS Ovisno o modelu / FA بر حسب مدل / AR حسب الموديل / TH ตามรุ่น / ZH 视型号而定

2.

[www.tefal.com](http://www.tefal.com)



[www.calor.fr](http://www.calor.fr)



**AUTO  
OFF**

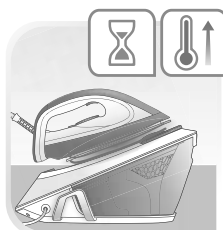
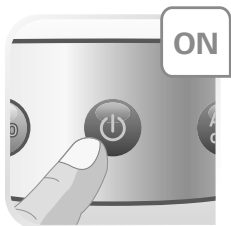
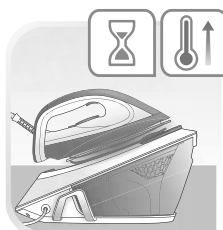
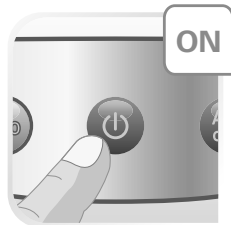
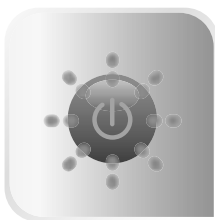

3.



[www.tefal.com](http://www.tefal.com)



[www.calor.fr](http://www.calor.fr)

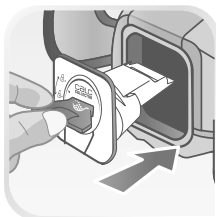
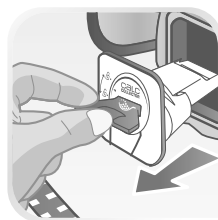
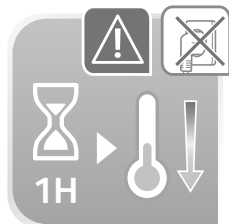
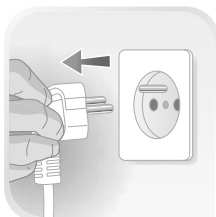
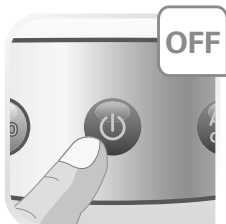

3.

[www.tefal.com](http://www.tefal.com)



[www.calor.fr](http://www.calor.fr)



**ANTI  
CALC**

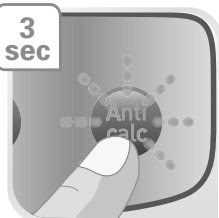
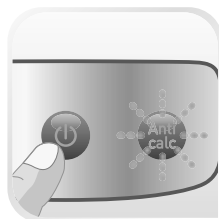
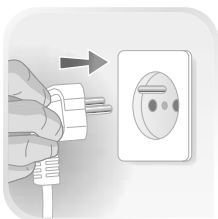
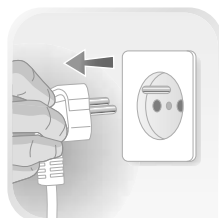
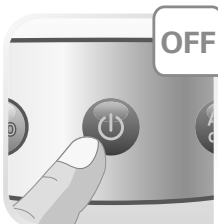



3.

[www.tefal.com](http://www.tefal.com)



[www.calor.fr](http://www.calor.fr)



...

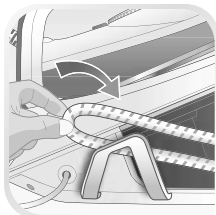
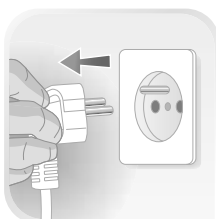
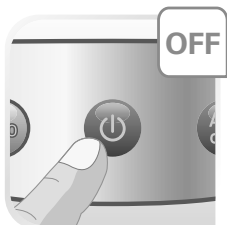
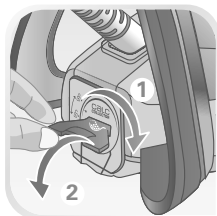

3.

[www.tefal.com](http://www.tefal.com)



[www.calor.fr](http://www.calor.fr)

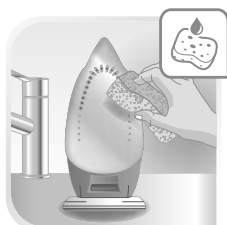
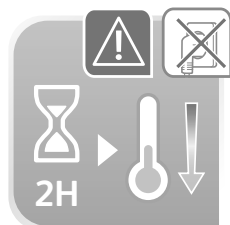
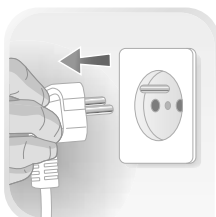
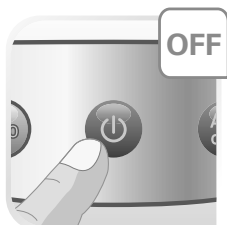

<b>FR</b> Guide de l'utilisateur	<b>HU</b> Használati útmutató
<b>EN</b> User's guide	<b>SL</b> Navodila za uporabnika
<b>DE</b> Bedienungsanleitung	<b>RU</b> Руководство пользователя
<b>NL</b> Gebruiksaanwijzing	<b>UK</b> Посібник користувача
<b>ES</b> Guía del usuario	<b>HR</b> Upute za uporabu
<b>PT</b> Guia del usuario	<b>RO</b> Ghidul utilizatorului
<b>IT</b> Manuale d'uso	<b>ET</b> Kasutusjuhend
<b>DA</b> Brugsvejledning	<b>LT</b> Naudotojo vadovas
<b>NO</b> Bruksanvisning	<b>LV</b> Lietošanas pamācība
<b>SV</b> Användarhandbok	<b>BG</b> Ръководство на потребителя
<b>FI</b> Käyttöopas	<b>SR</b> Korisničko uputstvo
<b>TR</b> Kullanım kılavuzu	<b>BS</b> Korisnički priručnik
<b>EL</b> Οδηγός χρήσης	<b>FA</b> راهنمای کاربر
<b>PL</b> Instrukcja obsługi	<b>AR</b> دليل المستخدم
<b>CS</b> Návod k použití	<b>TH</b> คู่มือสำหรับผู้ใช้งาน
<b>SK</b> Používateľská príručka	<b>ZH</b> 使用指南



## Express Compact

**FR** Pour plus d'informations sur l'utilisation / **EN** For further usage information / **DE** Weitere Informationen zur Bedienung / **NL** Voor meer informatie over het gebruik / **ES** Para obtener más información sobre su uso / **PT** Para obter mais informações sobre a utilização / **IT** Per maggiori informazioni sull'utilizzo / **DA** Yderligere informationer vedrørende betjening / **NO** For mer informasjon om bruken / **SV** För mer information om användningen / **FI** Lisätietoä käyttöä varten / **TR** Kullanım hakkında daha fazla bilgi için / **EL** Για περισσότερες πληροφορίες σχετικά με τη χρήση / **PL** Więcej informacji na temat korzystania z urządzenia / **CS** Pro více informací o použití / **SK** Pre ďalšie informácie o používaní / **HU** A használatra vonatkozó további információk / **SL** Več informacij o uporabi / **RU** Для получения более подробной информации об эксплуатации / **UK** Для отримання детальнішої інформації щодо експлуатації / **HR** Za više informacija o upotrebi / **RO** Pentru mai multe informații privind utilizarea / **ET** Täiendava teabe saamiseks kasutamise kohta / **LT** Daugiau informacijos apie naudojimą / **LV** Lai iegūtu vairāk informācijas par lietošanu / **BG** За още информация относно употребата / **BS** Za više informacija o upotrebi / **SR** Za više informacija o upotrebi / **FA** برای اطلاعات بیشتر درباره نحوه استفاده / **AR** للمزيد من المعلومات عن الاستخدام / **TH** สำหรับข้อมูลเพิ่มเติมเกี่ยวกับการใช้งาน / **ZH** 更多关于使用的信息:

Ovaj dokument je originalno proizveden i objavljen od strane proizvođača, brenda Tefal, i preuzet je sa njihove zvanične stranice. S obzirom na ovu činjenicu, Tehnoteka ističe da ne preuzima odgovornost za tačnost, celovitost ili pouzdanost informacija, podataka, mišljenja, saveta ili izjava sadržanih u ovom dokumentu.

Napominjemo da Tehnoteka nema ovlašćenje da izvrši bilo kakve izmene ili dopune na ovom dokumentu, stoga nismo odgovorni za eventualne greške, propuste ili netačnosti koje se mogu naći unutar njega. Tehnoteka ne odgovara za štetu nanесenu korisnicima pri upotrebi netačnih podataka. Ukoliko imate dodatna pitanja o proizvodu, ljubazno vas molimo da kontaktirate direktno proizvođača kako biste dobili sve detaljne informacije.

Za najnovije informacije o ceni, dostupnim akcijama i tehničkim karakteristikama proizvoda koji se pominje u ovom dokumentu, molimo posetite našu stranicu klikom na sledeći link:

<https://tehnoteka.rs/p/tefal-parna-stanica-sv7111-akcija-cena/>