

## Uputstvo za upotrebu (EN)

RAZER tastatura Tartarus Pro



Tehnoteka je online destinacija za upoređivanje cena i karakteristika bele tehnike, potrošačke elektronike i IT uređaja kod trgovinskih lanaca i internet prodavnica u Srbiji. Naša stranica vam omogućava da istražite najnovije informacije, detaljne karakteristike i konkurentne cene proizvoda.

Posetite nas i uživajte u ekskluzivnom iskustvu pametne kupovine klikom na link:

<https://tehnoteka.rs/p/razer-tastatura-tartarus-pro-akcija-cena/>



# RAZER TARTARUS PRO

MASTER GUIDE

Take hold of your game with the **Razer Tartarus Pro** and never let victory escape your grasp. Experience measured, nuanced control with its Razer Optical Analog Switches that have adjustable actuation, while arming yourself with a deadly arsenal of commands and macros across 32 programmable keys.

# CONTENTS

1. WHAT'S INSIDE / WHAT'S NEEDED.....	7
2. LET'S GET YOU COVERED.....	8
3. TECHNICAL SPECIFICATIONS.....	9
4. USING YOUR GAMING KEYPAD.....	10
5. CONFIGURING YOUR RAZER TARTARUS PRO VIA RAZER SYNAPSE.....	12
6. SAFETY AND MAINTENANCE .....	27
7. LEGALESE.....	28

---

## 1. WHAT'S INSIDE / WHAT'S NEEDED

### WHAT'S INSIDE

- Razer Tartarus Pro



- A. Adjustable palm rest
- B. Scroll wheel
- C. Keymap indicator
- D. Hyperspace thumb button
- E. 8-way directional thumbpad
- F. Spacebar actuator

- Important Product Information Guide

### WHAT'S NEEDED

#### PRODUCT REQUIREMENTS

- PC with a free USB port

#### RAZER SYNAPSE REQUIREMENTS

- Windows® 7 64-bit (or higher)
- Internet connection for software installation

---

## 2. LET'S GET YOU COVERED

You've got a great device in your hands, complete with a 2-year limited warranty coverage. Now maximize its potential and score exclusive Razer benefits by registering at [razerid.razer.com](https://razerid.razer.com)

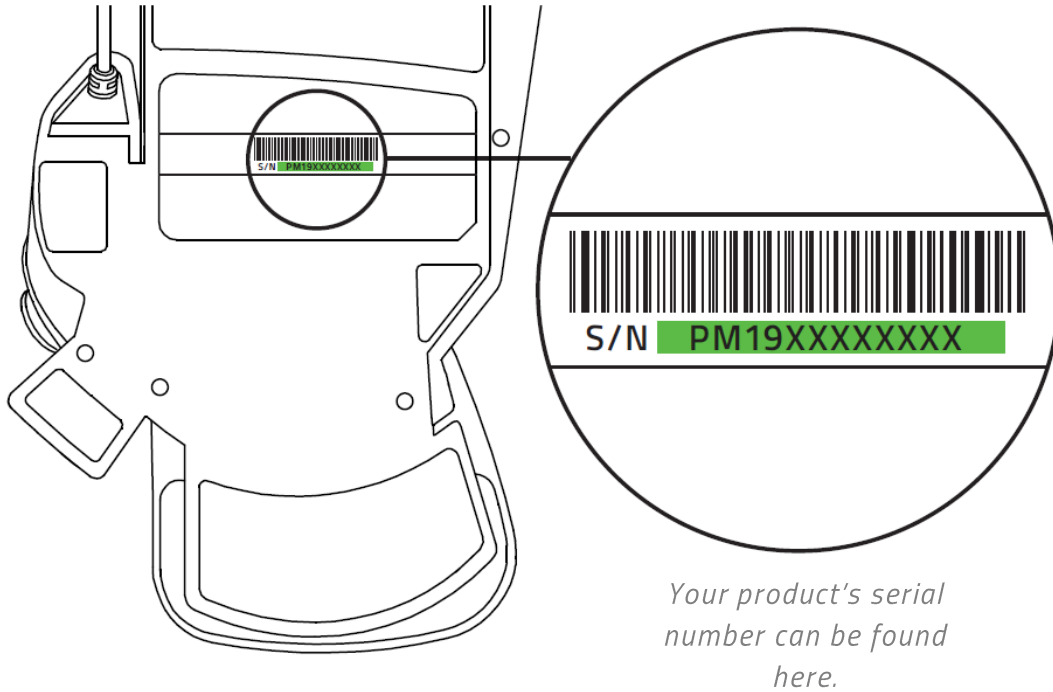

Got a question? Ask the Razer Support Team at [support.razer.com](https://support.razer.com)

---

## 3. TECHNICAL SPECIFICATIONS

### FEATURES

- Razer Analog Optical Switches
- Adjustable actuation
- Dual-function keys
- 32 fully programmable keys with programmable 8-way directional thumb-pad
- Chroma backlighting with 16.8 million customizable color options
- Instantaneous switching between 8 key maps
- Unlimited macro lengths
- Razer Synapse enabled
- Braided fiber cable

---

## 4. USING YOUR GAMING KEYPAD

### ADJUSTING THE PALM REST

You may adjust the palm rest to improve your overall gaming comfort.

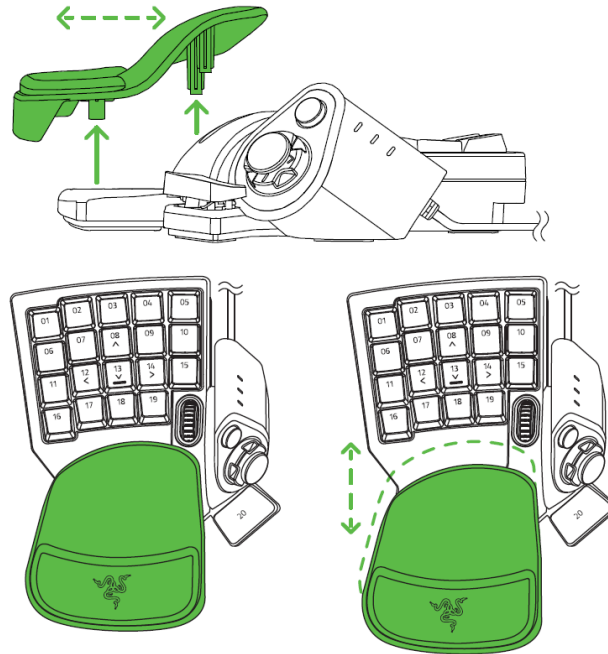

### CHANGING THE THUMBPAD

If you prefer using directional buttons instead of the thumb stick, simply remove the thumb stick from the thumb pad.

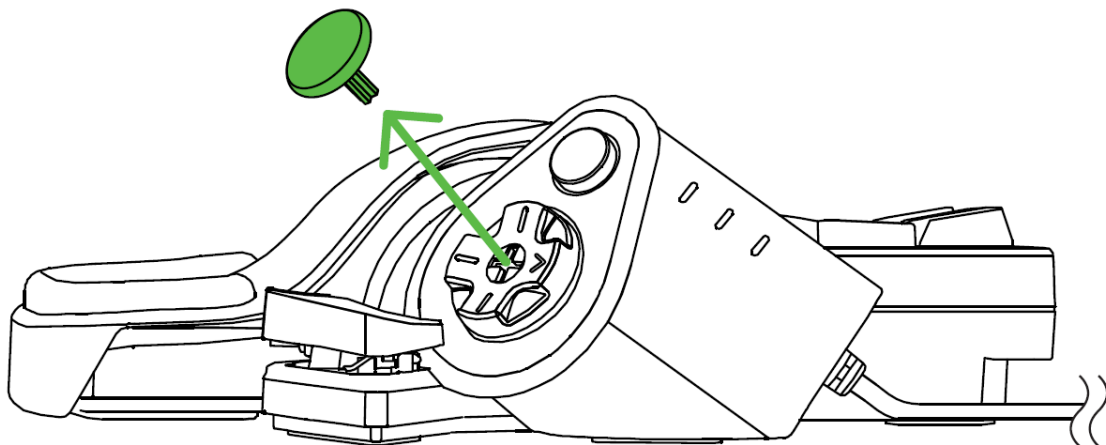



## INSTALLING RAZER SYNAPSE

Use the Razer Synapse\* app to create new keymaps, switch to any available keymap that matches your current playstyle, and even customize your device's lighting. The default mapping of your device can be seen below.

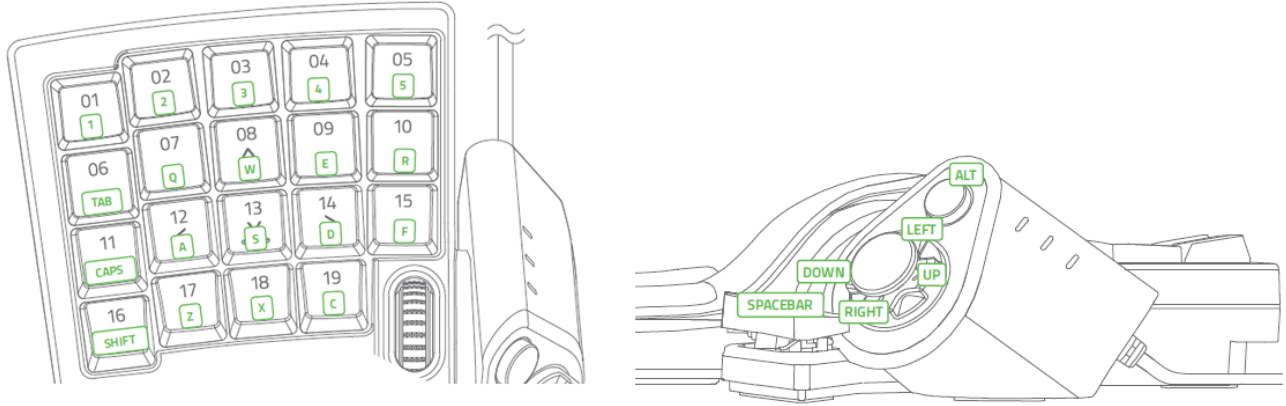

\*Install Razer Synapse when prompted or download the installer from [razer.com/synapse](https://razer.com/synapse).

---

## 5. CONFIGURING YOUR RAZER TARTARUS PRO VIA RAZER SYNAPSE

**i** *Disclaimer: Internet connection is required for installation, updates and cloud-based features. Registering for a Razer ID account is recommended, but optional. All listed features are subject to change based on the current software version, connected device(s), and supported apps and software.*

### SYNAPSE TAB

The Synapse tab is your default tab when you first launch Razer Synapse.

#### Dashboard

The Dashboard subtab is an overview of your Razer Synapse where you can access all your Razer devices, modules, and online services.

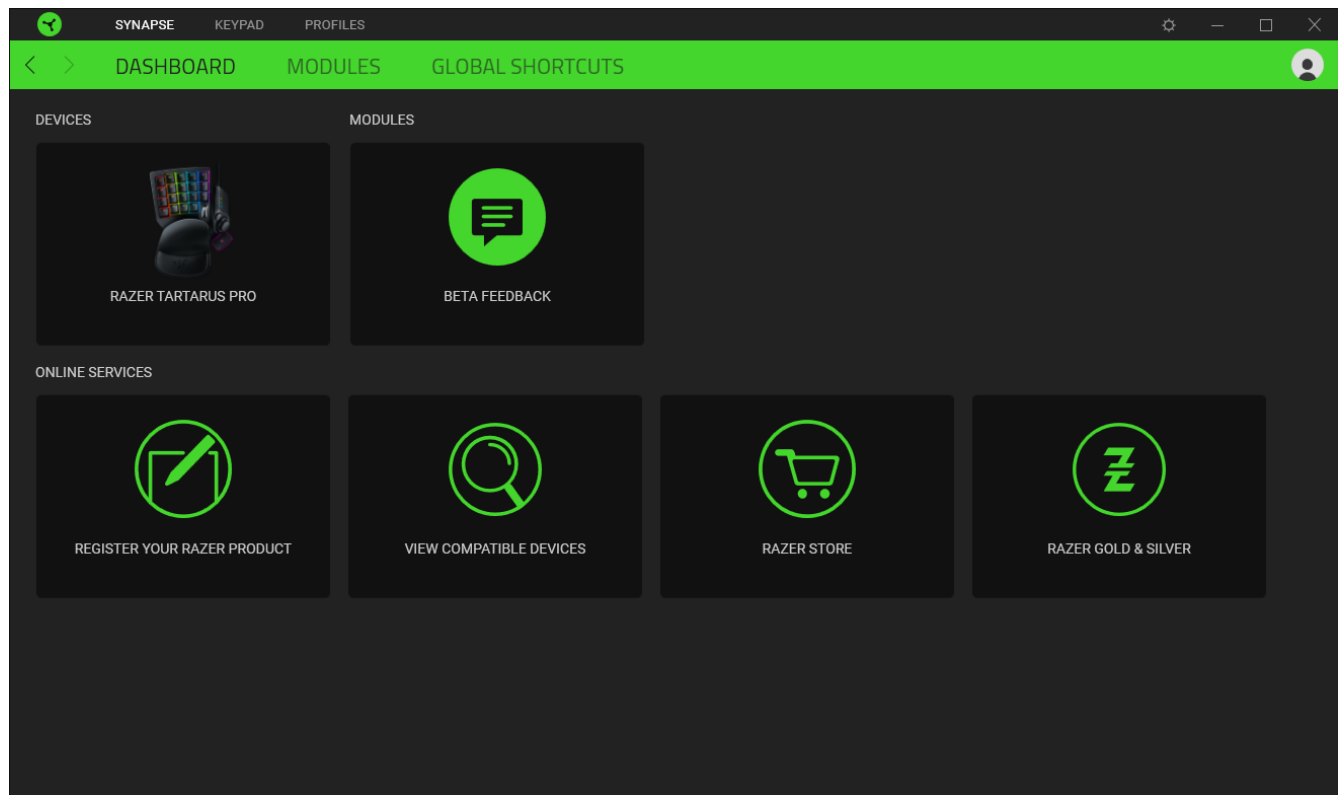

## Modules

The Modules subtab displays all installed and available modules for installation.

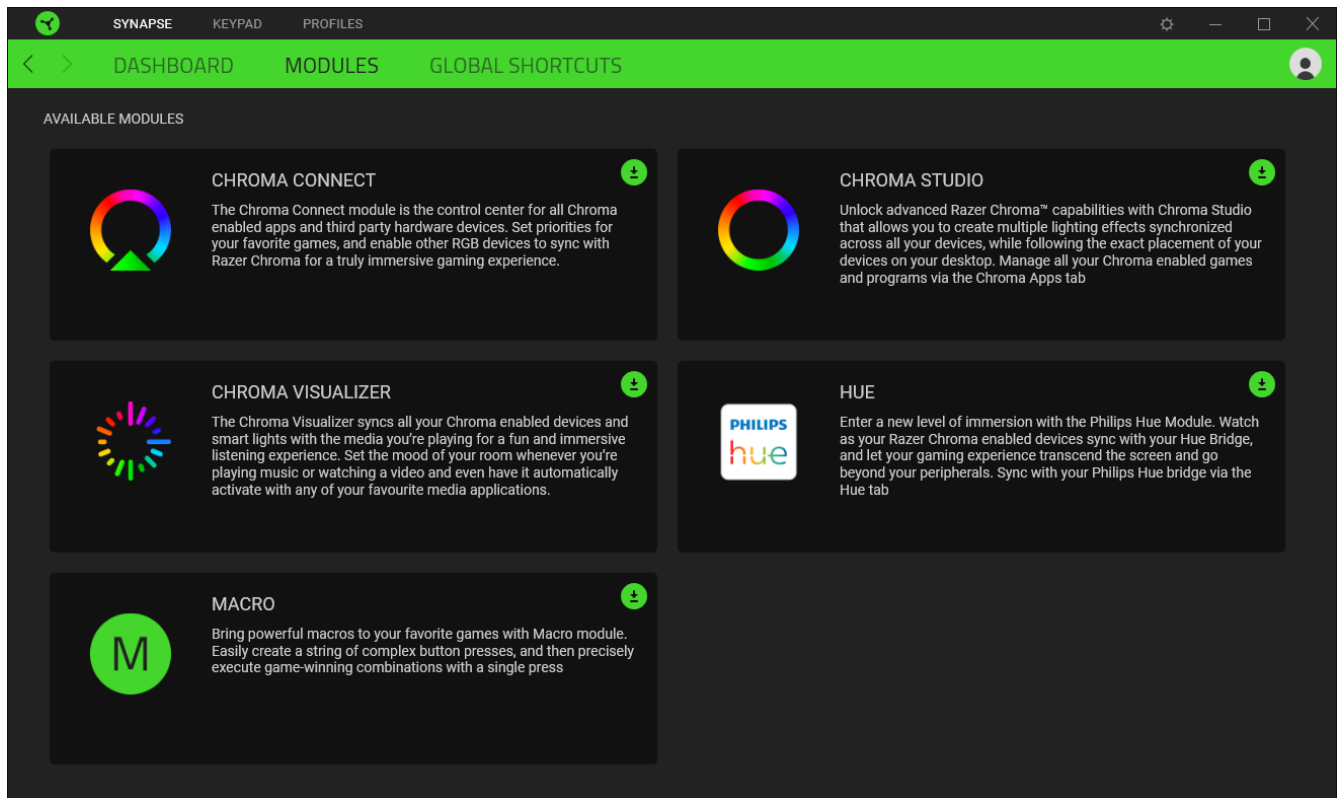

## Global Shortcuts

Bind operations or Razer Synapse functions to custom key-combinations from any Razer Synapse-enabled device inputs which apply across all device profiles.



*Only Razer Synapse-enabled device inputs will be recognized.*

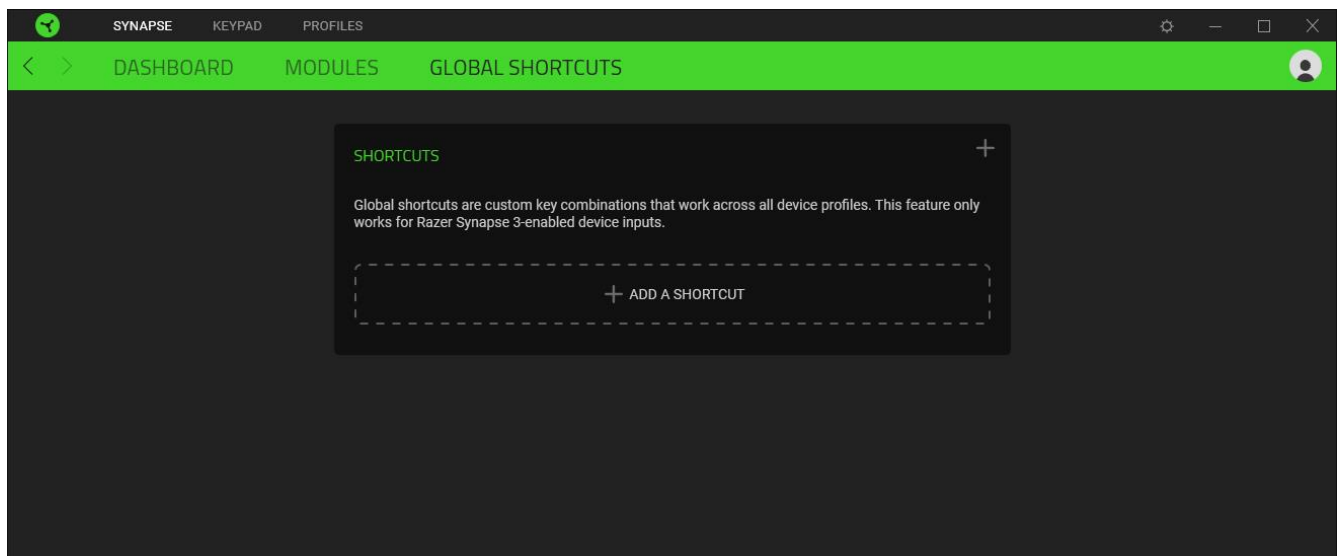

## KEYPAD

The Keypad tab is the main tab for your Razer Tartarus Pro. From here, you can change various settings such as your device's lighting and each keymap's key assignments, scroll wheel and current thumbpad function. Changes made under this tab are automatically saved to your system and cloud storage.

### Customize

The Customize subtab is for modifying the key assignments for each keymap you have on your device.

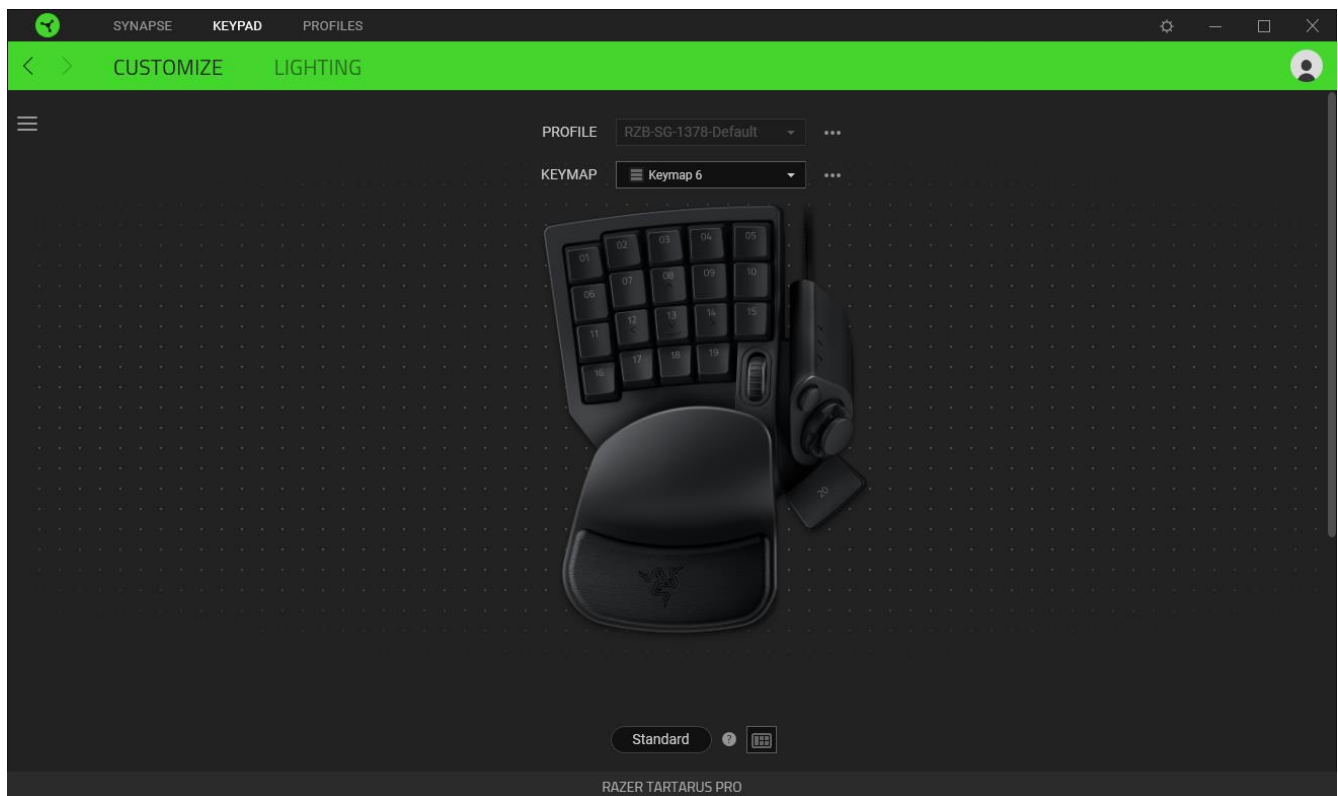

### Profile

A Profile is a data storage for keeping all your Razer devices' settings. By default, the profile name is based on your system's name. To add, import, rename, duplicate, export, or delete a profile, simply press the profile's corresponding Miscellaneous button ( ●●● ).

### Keymap



Keymaps are especially useful for games which require different playstyles for various character classes. With keymaps, you can have up to 8 sets of key assignments per profile, each represented by a color on the Keymap Indicator to make it easier to see which keymap is currently active. To

add, rename, duplicate, or delete a keymap, simply press the keymap's corresponding Miscellaneous button ( ●●● ).

### *Hypershift*

Hypershift mode is a secondary set of key assignments that is activated when the Hypershift key is held down. By default, the Hypershift key is assigned to the FN key of your Razer Synapse supported keyboard however, you can also assign any key as a Hypershift key.

### *Toggle Console View*

Toggle Console View (  ) shows or hides the sidebar (  ) including other keypad controls which you can modify on each Keymap such as its scroll wheel and thumbpad function. [Learn more about the Sidebar](#)

### *Keyboard Properties*

Opens the Windows Keyboard Properties where you can modify other keyboard settings such as Repeat delay, Repeat Rate, and Cursor blink rate, or view all keyboard drivers installed in your PC.

### *Game Controller Properties*

Opens the Windows Game Controllers Properties where you can calibrate your device's analog stick inputs and see how quickly it responds and registers movement.

### *Actuation point*

Set an estimated key travel (in millimeters) for both the Primary and Secondary actuation points to adjust how sensitive your keys are before each point registers as an input. You'll find the secondary actuation point useful if you want to activate a secondary function on any key using your preferred key travel distance. [Learn more about Secondary functions](#)

 *As the secondary actuation is a lower actuation point, the key travel distance must be equal or greater than the primary actuation point distance.*

## Sidebar

Clicking the Sidebar button (☰) will reveal all current key and button assignments on your device.

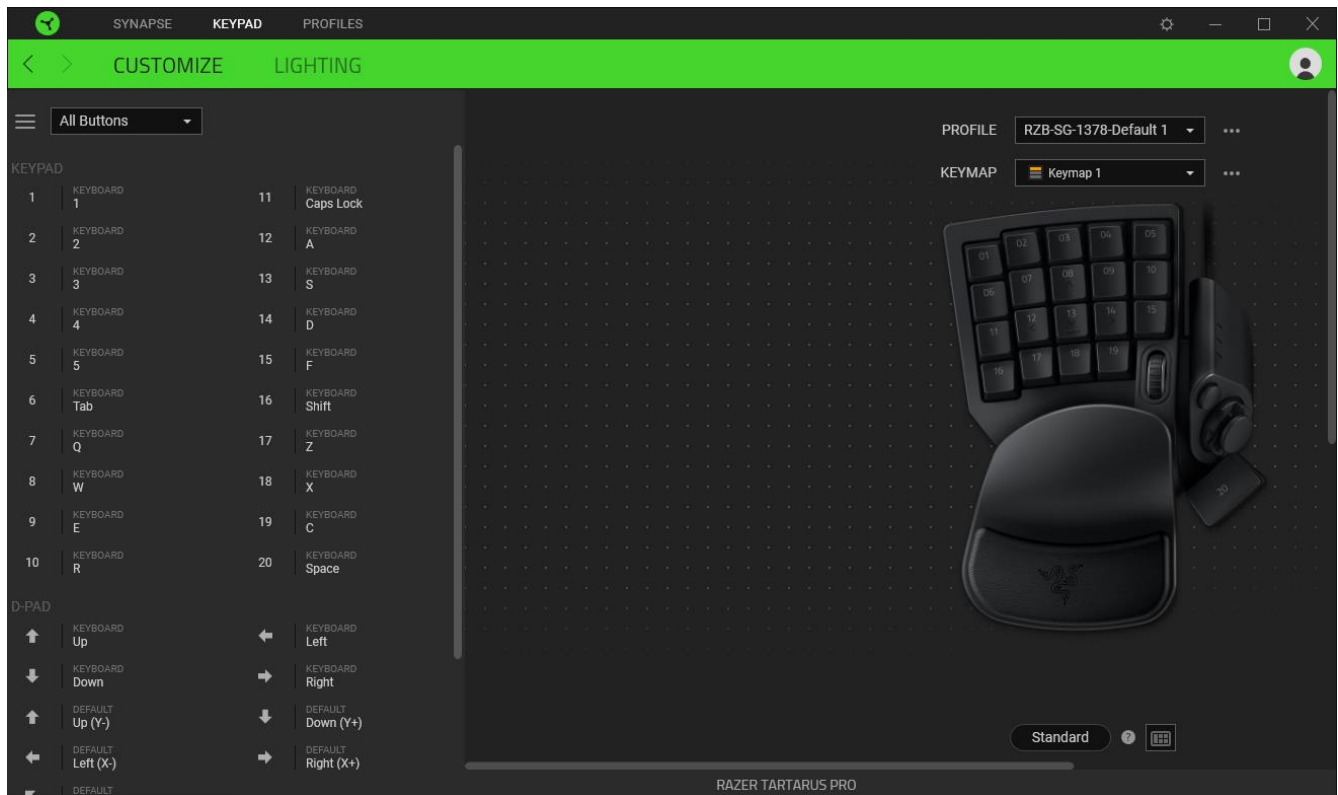

Alternatively, you can skip to a specific key assignment by selecting it on the Customize tab.

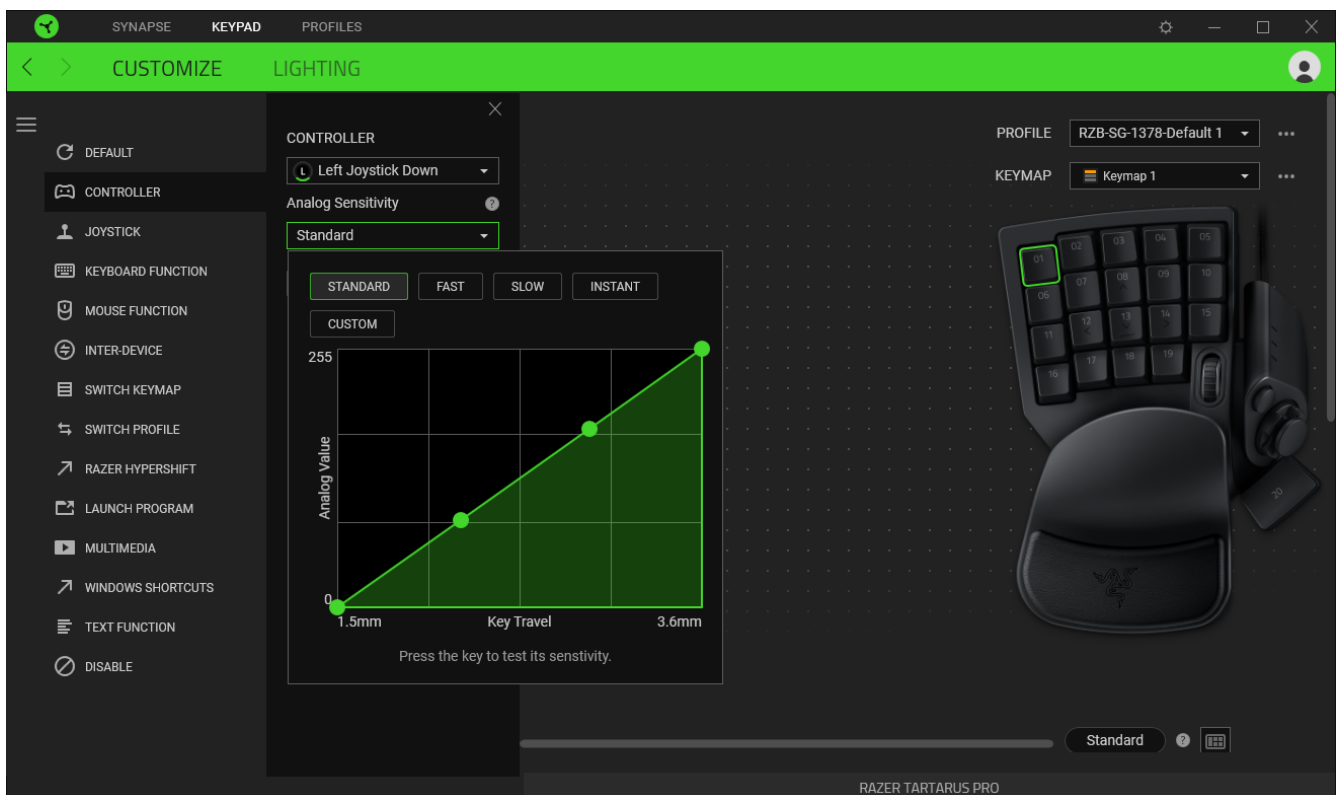

Upon selecting a key assignment, you may then change it to one of the following functions:

### Default

This option enables you to return the selected key to its original setting.

### Controller

Changes the function of the selected key to a controller function. Some controller functions such as bumpers / triggers and joystick movements may include Analog Sensitivity for you to control the precision of controller movements using presets or your own custom sensitivity by adjusting the analog curve. You may test the selected key's sensitivity by pressing and referring to the real-time preview of the pressed key.

 *This feature is recommended for most games that work with gamepads.*

### Joystick

This option enables you to change the functionality of any key into a joystick button or an analog stick direction.

### Keyboard Function

This option changes the key assignment into any keyboard function and even allows you to activate a second function when the selected key is pressed further. Some keyboard function presets allow you to include keyboard modifiers (Shift, Control, and Alt) if you want to assign a keyboard shortcut to the selected key.

You may also enable a Turbo mode function to repeatedly emulate the pressing and releasing of the primary function (or the secondary function, if present) while the key is held down.

### Mouse Function

This option allows you to change any key into a mouse function. Listed below are the functions which you can choose from:

- Left Click - Performs a left mouse click using the assigned button.
- Right Click - Performs a right mouse click using the assigned button.
- Scroll Click - Activates the universal scrolling function.
- Double Click - Performs a double left click using the assigned button.
- Mouse Button 4 - Performs a "Backward" command for most internet browsers.

- Mouse Button 5 - Performs a "Forward" command for most internet browsers.
- Scroll Up - Performs a "Scroll Up" command using the assigned button.
- Scroll Down - Performs a "Scroll Down" command using the assigned button.
- Scroll Left - Performs a "Scroll Left" command using the assigned button.
- Scroll Right - Performs a "Scroll Right" command using the assigned button.

You can also choose to enable Turbo mode in some of the mouse functions to repeatedly emulate the pressing and releasing of the said function while the key is held down.

## M Macro

A Macro is a prerecorded sequence of keystrokes and button presses that is executed with precise timing. By setting the key function to Macro, you can conveniently execute a chain of commands. This function will only be visible when the Macro module is installed.

## ↔ Inter-device

Inter-device allows you to change the functionality of other Razer Synapse-enabled devices. Some of these functionalities are device-specific such as using your Razer gaming keyboard to change the Sensitivity Stage of your Razer gaming mouse.

## ☰ Switch Keymap

Switch Keymap allows you to swap key assignments with a press of a key. The keymap indicator will automatically change color as you switch between keymaps. Listed below are the functions which you can choose from:

- Next Keymap – Switch to the next keymap on the list.
- Previous Keymap – Switch to the previously active keymap.
- Cycle Up Keymap – Cycle to the first keymap on the list.
- Cycle Down Keymap – Cycle to the last keymap on the list.
- Specific Keymap – Jump to a specific keymap of your choice. You may select the **Switch back to previous Keymap when this button is released** option if you want to only activate the specified keymap while the selected key is held down.



## Switch Profile

Switch Profile enables you to quickly change profiles and load a new set of key assignments. An on-screen notification will appear whenever you switch profiles. Listed below are the functions which you can choose from:

- Next Profile – Switch to the next profile on the list.
- Previous Profile – Switch to the previously active profile.
- Cycle Up Profile – Cycle to the first keymap on the list.
- Cycle Down Profile – Cycle to the last keymap on the list.
- Specific Profile – Jump to a specific profile of your choice. You may select the **Switch Lighting when profile is switched** option if you want to activate a specific Chroma effect whenever switching to the specific profile.

## Switch Lighting

Switch Lighting allows you to easily switch between all advanced lighting effects. This function will only be visible when the Chroma Studio module is installed.

## Razer Hypershift

Setting the key to Razer Hypershift will allow you to activate Hypershift mode as long as the key is held down.

## Launch Program

Launch Program enables you to open an app or a website using the assigned key. When you select Launch Program, two choices will appear which requires you to search for a specific app you want to open, or write the address of the website you want to visit.

## Multimedia

This option allows you to assign multimedia controls to your Razer device. Listed below are the multimedia controls you can choose from:

- Volume Down - Decreases the audio output.
- Volume Up - Increases the audio output.
- Mute Volume - Mutes the audio.
- Mic Volume Up - Increases the microphone volume.

- Mic Volume Down - Decreases the microphone volume.
- Mute Mic - Mutes the microphone.
- Mute All - Mutes both microphone and audio output.
- Play / Pause - Play, pause, or resume playback of the current media.
- Previous Track - Play the previous media track.
- Next Track - Play the next media track.

## Windows Shortcuts

This option allows you to assign your preferred key into a Windows Operating System shortcut command. For more information, please visit: [support.microsoft.com/kb/126449](https://support.microsoft.com/kb/126449)

## Text Function

Text Function enables you to type a prewritten text with a touch of a key. Simply write your desired text on the given field and your text will be typed whenever the assigned key is pressed. This function has full Unicode support and you can also insert special symbols from character maps.

## Disable

This option renders the assigned key unusable. Use Disable if you do not want to use the selected key or if it interferes with your gaming.

## Lighting

The Lighting subtab enables you to modify your Razer device's light settings.

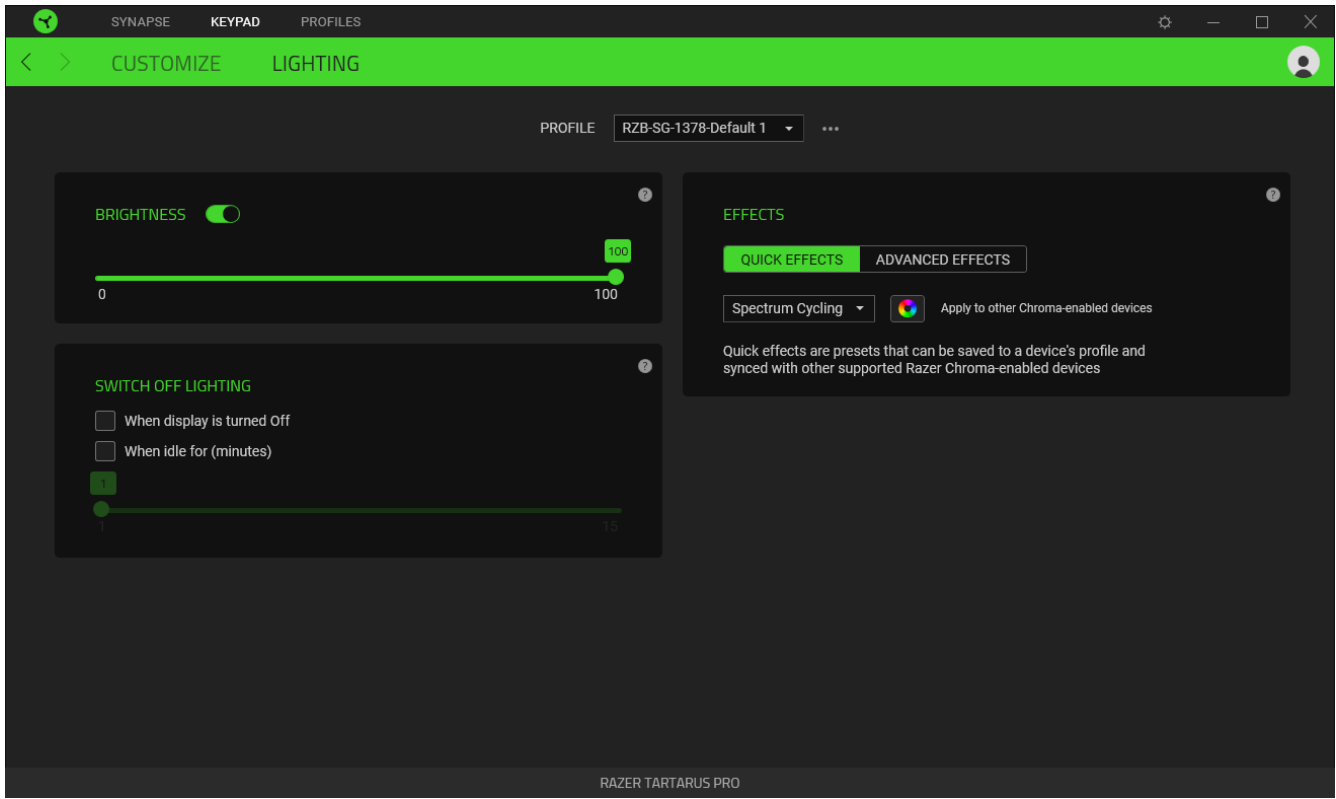

### Brightness

You can turn off your Razer device's lighting by toggling the Brightness option or increase/decrease the luminance using the slider.









### Switch Off Lighting

This is a power saving tool which allows you to disable your device's lighting in response to your system's display turning off and/or automatically power down when your Razer Tartarus Pro has been idle for a set amount of time.

### Quick Effects

A number of quick effects can be selected and applied to your device's lighting, as listed here:

	Name	Description	How to set up
	Audio meter	The LEDs will light up according to the audio level with a default spectrum of colors	Select a Color Boost level

	Breathing	The lighting will fade in and out of the selected color(s)	Select up to 2 colors or randomize colors
	Fire	The LEDs will light up in warm colors to mimic the motion of flames	No further customization required
	Reactive	The LEDs will light up when a key is pressed. The light will fade off after a specified period of time	Select a color and a duration
	Ripple	On key press, light will ripple away from the pressed key	Select a color
	Spectrum cycling	The lighting will cycle between 16.8 million colors indefinitely	No further customization required
	Starlight	Each LED will have a chance of fading in and out at a random time and duration	Select up to 2 colors or randomize colors and select a duration
	Static	The LEDs will remain lit in the selected color	Select a color
	Wave	The lighting will scroll in the direction selected	Select either left-to-right or right-to-left wave direction

If you have other supported Razer Chroma-enabled devices, you can synchronize their quick effects with your Razer device by clicking the Chroma Sync button (  ).

 *Only devices that support the selected lighting effect will synchronize.*

### Advanced Effects

The Advanced Effects option allows you to choose a Chroma Effect you want to use on your Razer Chroma-enabled peripheral. To start making your own Chroma Effect, simply press the Chroma Studio button (  ).



## PROFILES TAB

The Profiles tab is a convenient way of managing all your profiles and linking them to your games and applications.

### Devices

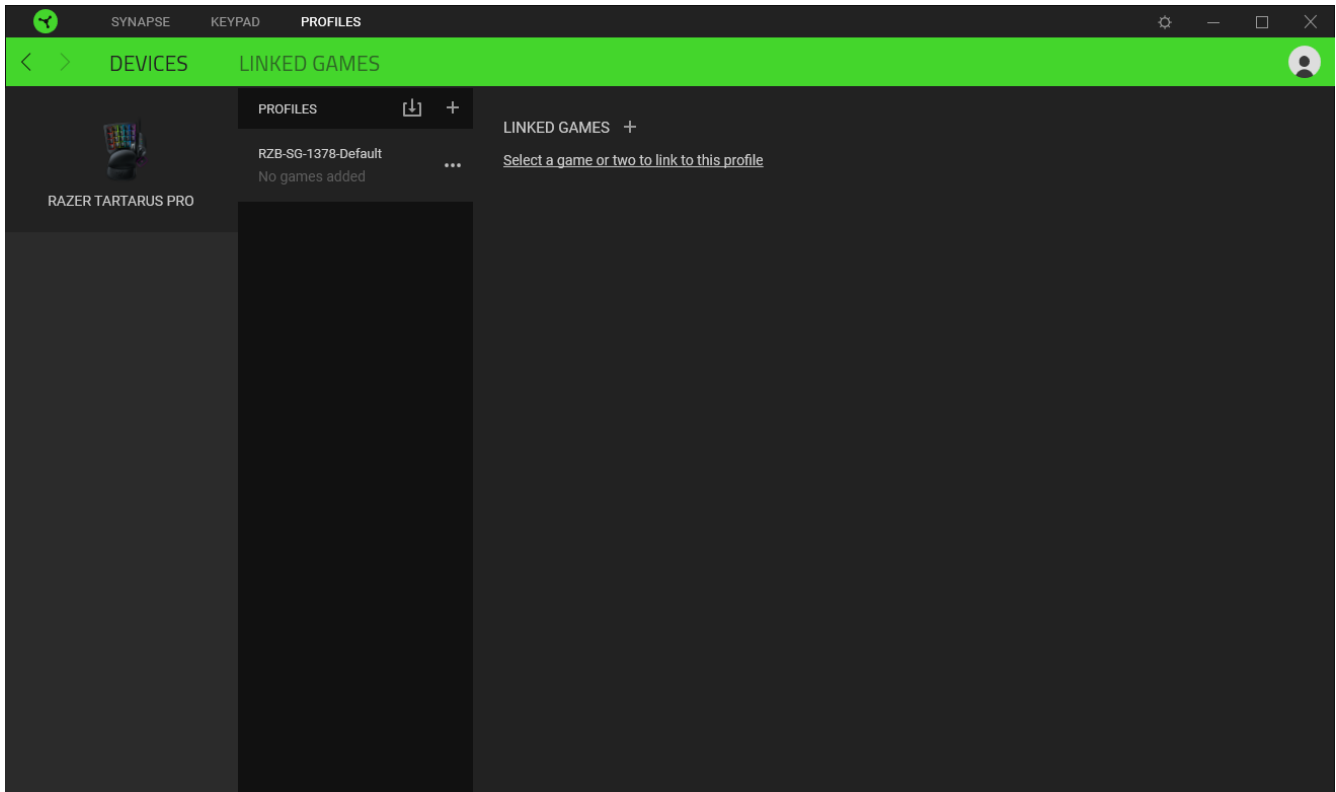
View which Razer device is using a specific profile using the Devices subtab.



You can import Profiles from your computer or from the cloud through the import button (  ) or create new profiles within the selected device using the add button (  ). To rename, duplicate, export, or delete a profile, simply press the Miscellaneous button (  ). Each profile can be set to automatically activate when you run an application using the Linked Games option.

## Linked Games

The Linked Games subtab gives you the flexibility to add games, view peripherals that are linked to games, or search for added games. You can also sort games based on alphabetical order, last played, or most played. Added games will still be listed here even if it is not linked to a Razer device.

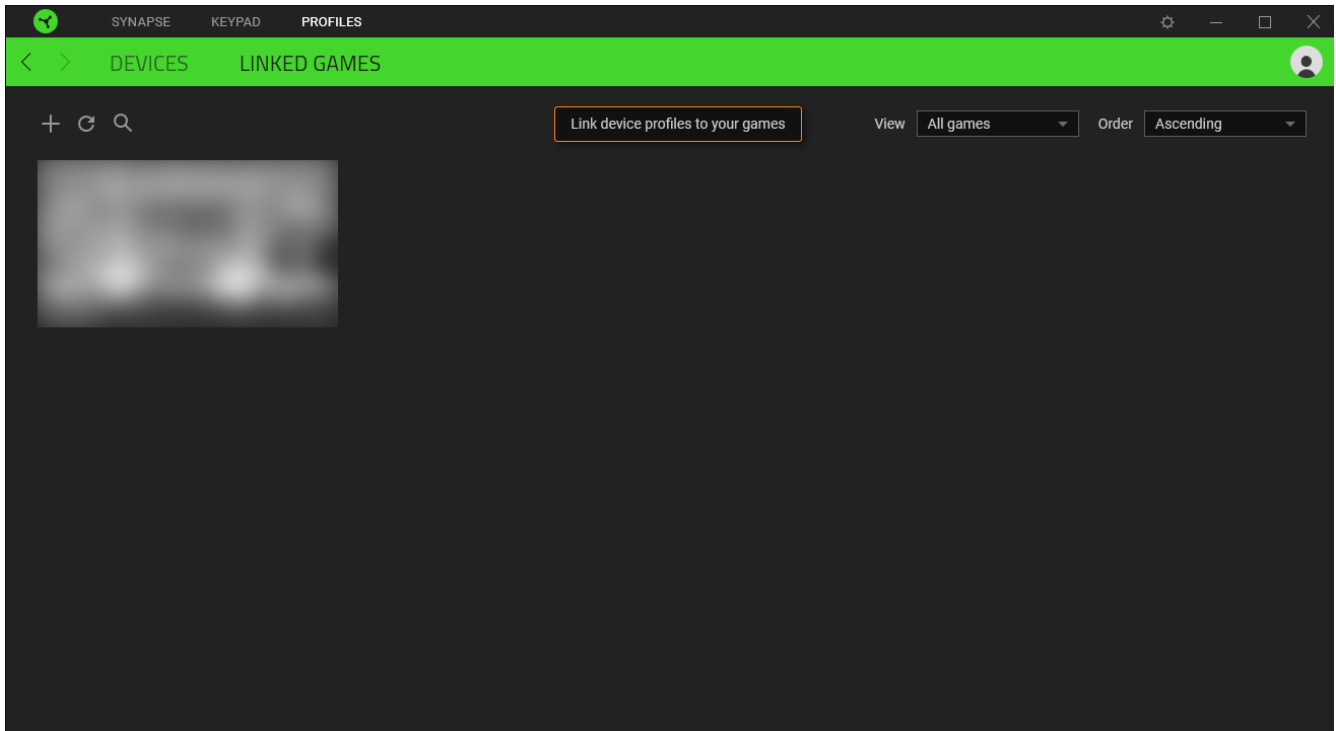

To link games to connected Razer devices, simply click on a game from the list, and then click **Select a device and its profile to launch automatically during gameplay** link to select the Razer device it will link with. Once linked, you may click on the Miscellaneous button ( ●●● ) of the corresponding device to select a specific profile.

## SETTINGS WINDOW

The Settings window, accessible by clicking the (⚙️) button on Razer Synapse, enables you to configure the startup behavior and display language of Razer Synapse, view the master guides of each connected Razer device, or perform factory reset on any connected Razer device.

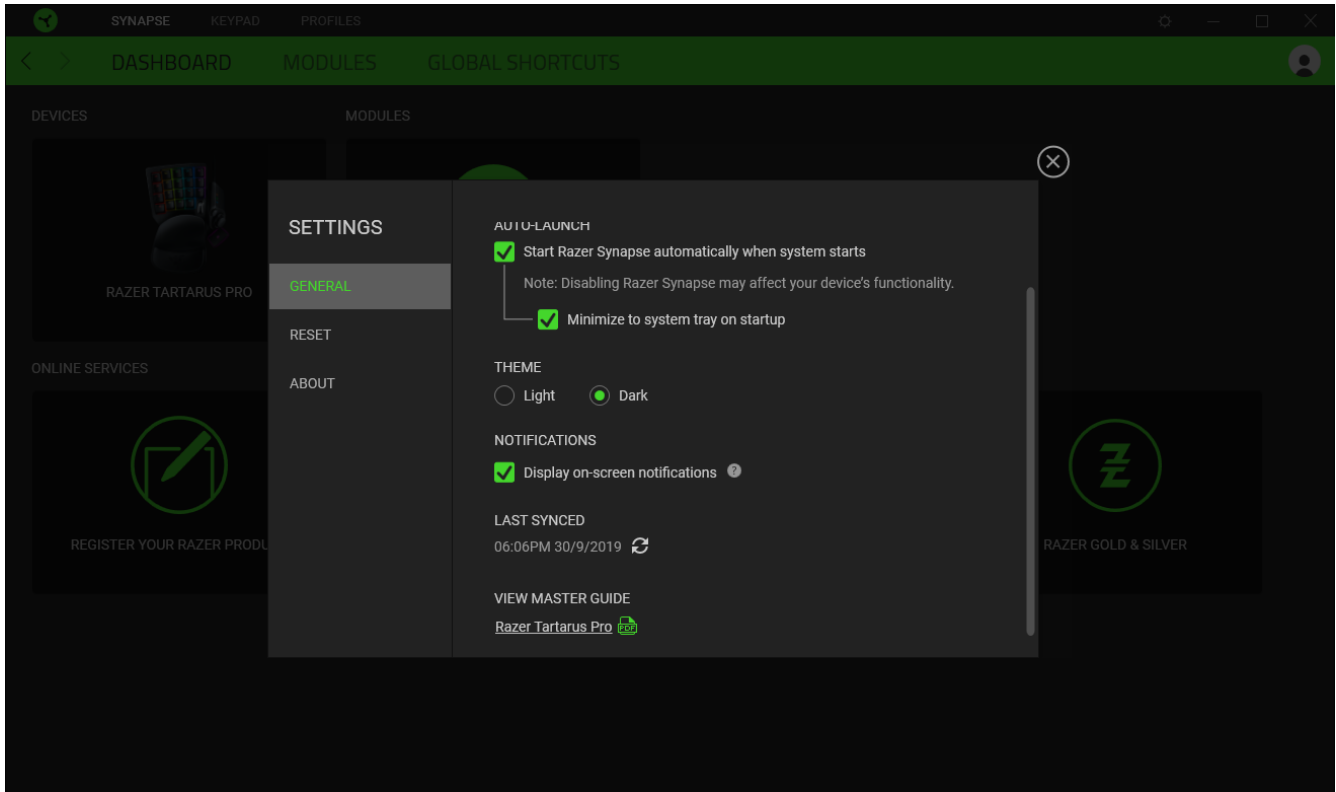

### General tab

The default tab of the Settings window. The General tab enables you to change the software's display language, start-up behavior, display theme, and on-screen notifications display. You may also manually sync your profiles to the cloud (↻) or view the master guide of all connected Razer devices and installed modules.

### Reset tab

The Reset tab allows you to perform a factory reset on any connected Razer device and/or reset Razer Synapse tutorials to acquaint yourself again with Razer Synapse's new features on its next launch.

**!** *By resetting a Razer device, all profiles on the selected device and its on-board memory (if present) will be erased.*

**About tab**

The About tab displays brief software information and copyright statement and provides relevant links for its terms of use. You may also use this tab to check for software updates, or as a quick access to Razer's social communities.



---

## 6. SAFETY AND MAINTENANCE

### SAFETY GUIDELINES

In order to achieve maximum safety while using your Razer Tartarus Pro, we suggest that you adopt the following guidelines:

Should you have trouble operating the device properly and troubleshooting does not work, unplug the device and contact the Razer hotline or go to [support.razer.com](https://support.razer.com) for assistance.

Do not take apart the device (doing so will void your warranty) and do not attempt to operate it under abnormal current loads.

Keep the device away from liquid, humidity or moisture. Operate the device only within the specific temperature range of 0°C (32°F) to 40°C (104°F). Should the temperature exceed this range, unplug and/or switch off the device in order to let the temperature stabilize to an optimal level.

### MAINTENANCE AND USE

The Razer Tartarus Pro requires minimum maintenance to keep it in optimum condition. Once a month we recommend you unplug the device and clean it using a soft cloth or cotton swab to prevent dirt buildup.

---

## 7. LEGALESE

### **COPYRIGHT AND INTELLECTUAL PROPERTY INFORMATION**

©2019 Razer Inc. All rights reserved. Razer, the triple-headed snake logo, Razer logo, “For Gamers. By Gamers.”, and “Powered by Razer Chroma” logo are trademarks or registered trademarks of Razer Inc. and/or affiliated companies in the United States or other countries. All other trademarks and trade names are the property of their respective owners and other company and product names mentioned herein may be trademarks of their respective companies.

Windows and the Windows logo are trademarks of the Microsoft group of companies.

Razer Inc. (“Razer”) may have copyright, trademarks, trade secrets, patents, patent applications, or other intellectual property rights (whether registered or unregistered) concerning the product in this guide. Furnishing of this guide does not give you a license to any such copyright, trademark, patent or other intellectual property right. The Razer Tartarus Pro (the “Product”) may differ from pictures whether on packaging or otherwise. Razer assumes no responsibility for such differences or for any errors that may appear. Information contained herein is subject to change without notice.

### **LIMITED PRODUCT WARRANTY**

For the latest and current terms of the Limited Product Warranty, please visit [razer.com/warranty](https://www.razer.com/warranty).

### **LIMITATION OF LIABILITY**

Razer shall in no event be liable for any lost profits, loss of information or data, special, incidental, indirect, punitive or consequential or incidental damages, arising in any way out of distribution of, sale of, resale of, use of, or inability to use the Product. In no event shall Razer’s liability exceed the retail purchase price of the Product.

### **GENERAL**

These terms shall be governed by and construed under the laws of the jurisdiction in which the Product was purchased. If any term herein is held to be invalid or unenforceable, then such term (in so far as it is invalid or unenforceable) shall be given no effect and deemed to be excluded without invalidating any of the remaining terms. Razer reserves the right to amend any term at any time without notice.

Ovaj dokument je originalno proizveden i objavljen od strane proizvođača, brenda Razer, i preuzet je sa njihove zvanične stranice. S obzirom na ovu činjenicu, Tehnoteka ističe da ne preuzima odgovornost za tačnost, celovitost ili pouzdanost informacija, podataka, mišljenja, saveta ili izjava sadržanih u ovom dokumentu.

Napominjemo da Tehnoteka nema ovlašćenje da izvrši bilo kakve izmene ili dopune na ovom dokumentu, stoga nismo odgovorni za eventualne greške, propuste ili netačnosti koje se mogu naći unutar njega. Tehnoteka ne odgovara za štetu nanесenu korisnicima pri upotrebi netačnih podataka. Ukoliko imate dodatna pitanja o proizvodu, ljubazno vas molimo da kontaktirate direktno proizvođača kako biste dobili sve detaljne informacije.

Za najnovije informacije o ceni, dostupnim akcijama i tehničkim karakteristikama proizvoda koji se pominje u ovom dokumentu, molimo posetite našu stranicu klikom na sledeći link:

<https://tehnoteka.rs/p/razer-tastatura-tartarus-pro-akcija-cena/>