

Uputstvo za upotrebu (EN)

RAZER bežična tastatura DeathStalker V2 Pro Linear crna



Tehnoteka je online destinacija za upoređivanje cena i karakteristika bele tehnike, potrošačke elektronike i IT uređaja kod trgovinskih lanaca i internet prodavnica u Srbiji. Naša stranica vam omogućava da istražite najnovije informacije, detaljne karakteristike i konkurentne cene proizvoda.

Posetite nas i uživajte u ekskluzivnom iskustvu pametne kupovine klikom na link:

<https://tehnoteka.rs/p/razer-bezicna-tastatura-deathstalker-v2-pro-linear-crna-akcija-cena/>



RAZER DEATHSTALKER V2 PRO

MASTER GUIDE

Meet the **Razer DeathStalker V2 Pro**—a wireless ultra-slim optical keyboard optimized for top-tier performance and durability. Featuring new low-profile switches and Razer HyperSpeed Wireless for ultra-responsive gaming, all housed within a durable, ultra-slim casing for long-lasting ergonomic use.

CONTENTS

1. WHAT'S INSIDE	3
2. WHAT'S NEEDED	5
3. LET'S GET YOU COVERED	5
4. TECHNICAL SPECIFICATIONS.....	6
5. SETTING UP YOUR RAZER DEATHSTALKER V2 PRO.....	7
6. USING YOUR RAZER DEATHSTALKER V2 PRO.....	12
7. CONFIGURING YOUR RAZER DEATHSTALKER V2 PRO.....	15
8. SAFETY AND MAINTENANCE	28
9. LEGALESE	30

1. WHAT'S INSIDE

- Razer DeathStalker V2 Pro

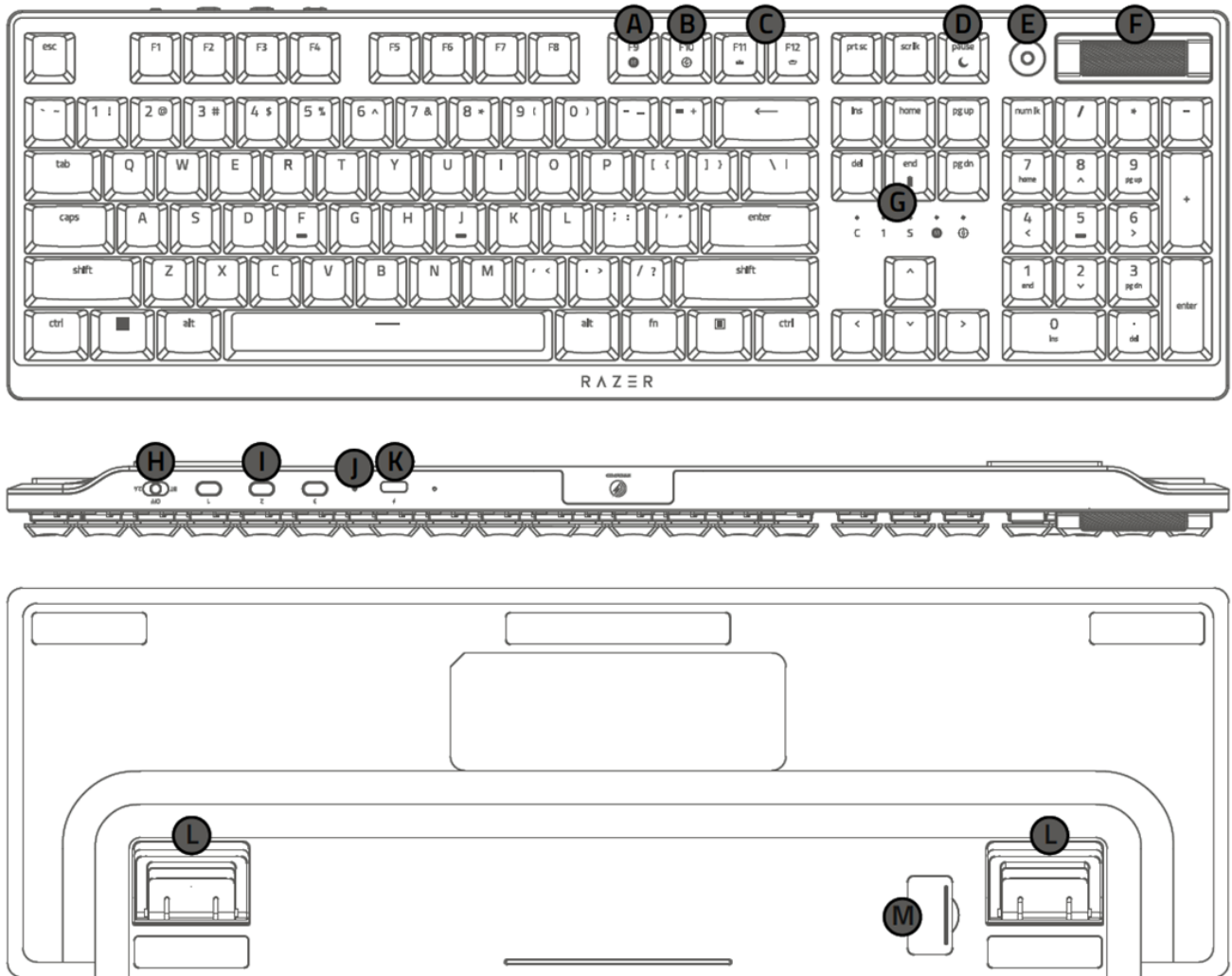

- A. On-The-Fly macro record key
 - B. Gaming mode key
 - C. Backlight control keys
 - D. Sleep mode key
 - E. Media control button
 - F. Volume control roller
 - G. LED indicators
 - H. Mode switch
 - I. Bluetooth profile buttons
 - J. Power indicator
 - K. Type C port
 - L. Kickstand
 - M. Magnetic dongle compartment
- 2.4GHz
 - Off (wired)
 - Bluetooth

- 2.4GHz wireless USB dongle

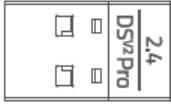

- Type A to Type C cable

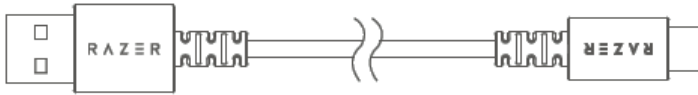

- Wireless USB extender



- Important Product Information Guide

2. WHAT'S NEEDED

PRODUCT REQUIREMENTS

- PC with a free USB port or Bluetooth 4.0 connectivity

RAZER SYNAPSE 3 REQUIREMENTS

- Windows® 10 64-bit (or higher)
- Internet connection for software installation

3. LET'S GET YOU COVERED

You've got a great device in your hands, complete with a 2-year limited warranty coverage. Now maximize its potential and score exclusive Razer benefits by registering at razerid.razer.com

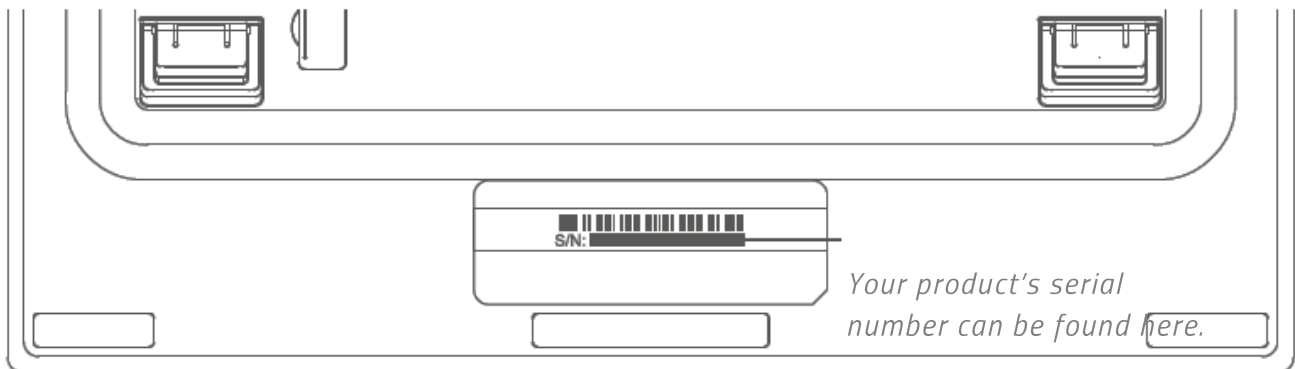

Got a question? Ask the Razer Support Team at support.razer.com

4. TECHNICAL SPECIFICATIONS

FEATURES

- Razer™ Low-Profile Optical Switches
- 70 million keystroke lifespan
- Razer™ HyperSpeed Wireless Technology
- Razer™ HyperSpeed Multi-device Support
- Connect via Razer™ HyperSpeed Wireless (2.4 Ghz), Bluetooth, or Type-C
- Multi-functional media button and media roller
- Ultra-durable coated ABS keycaps
- Razer Chroma™ RGB customizable backlighting with 16.8 million color options
- Razer Synapse enabled
- Hybrid On-Board Memory and Cloud Storage – up to 5 profiles
- Fully programmable keys with on-the-fly macro recording
- N-key roll over
- Gaming mode option
- Detachable braided fiber Type-C cable
- 5052 Aluminium Alloy Top Case

APPROXIMATE SIZE & WEIGHT

- Length: 437 mm / 17.2 in
- Width: 139 mm / 5.5 in
- Height: 26 mm / 1 in
- Weight: 776.5 g / 1.7 lbs

5. SETTING UP YOUR RAZER DEATHSTALKER V2 PRO

1. Connect your keyboard to a powered USB port using the Type C to Type A cable to charge your keyboard. The power indicator will turn solid green when the keyboard is fully charged.

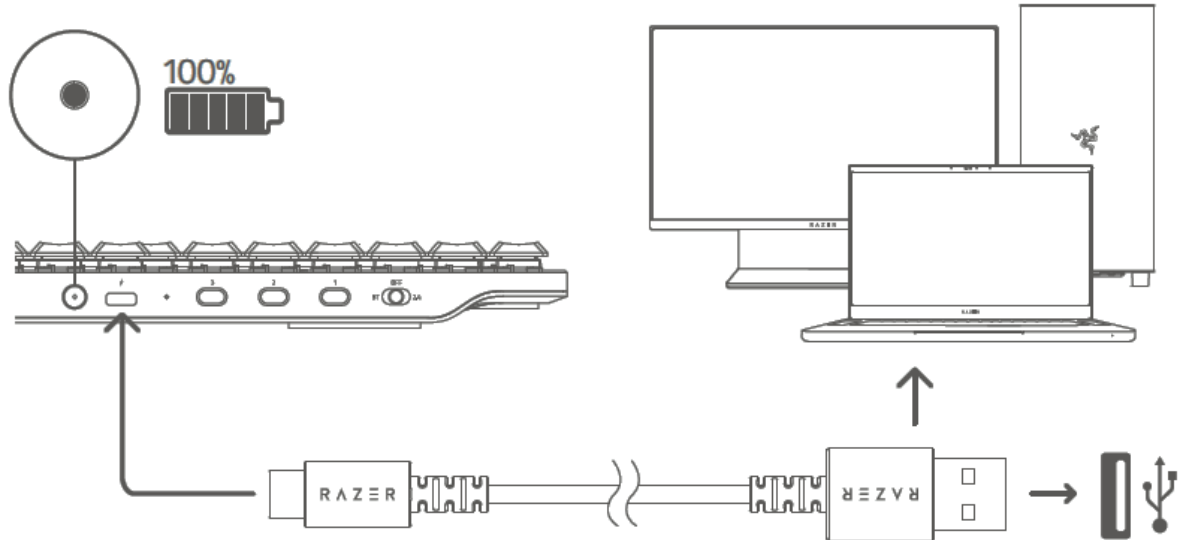

i For best results, fully charge your keyboard before using it for the first time. It takes approximately 2 hours to fully charge your keyboard. You may continue using the keyboard while plugged in.

When your keyboard is not charging, pressing the FN + End will activate the power indicator to briefly display its battery status.

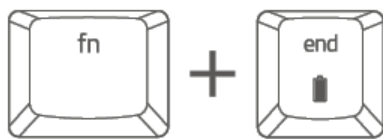

COLOR	STATUS
Red	Critical
Orange	Very Low
Yellow	Low
Green	Charged

2. Set the mode switch to your preferred mode.

2.4 GHz mode

1. Set the mode switch to 2.4.

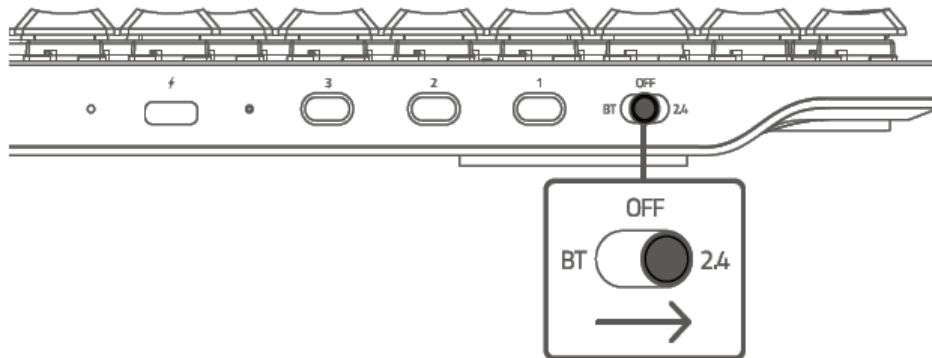

2. Detach the 2.4GHz wireless USB dongle from the magnetic dongle compartment and connect it to your computer.

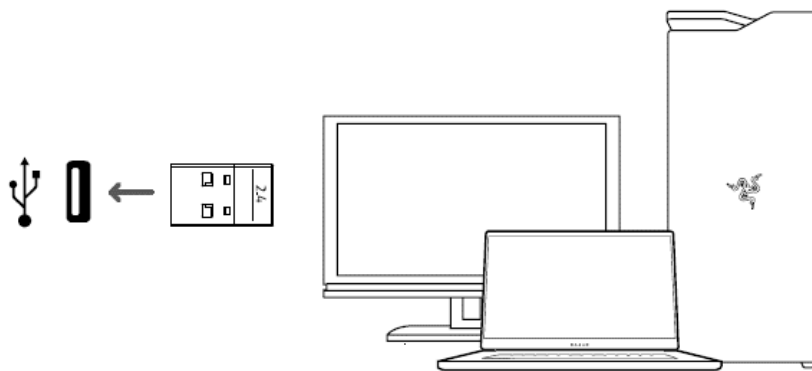

Use the wireless USB extender and Type A to Type C cable to increase the reach of your 2.4GHz wireless USB dongle if the signal is weak, intermittent, or out of range.

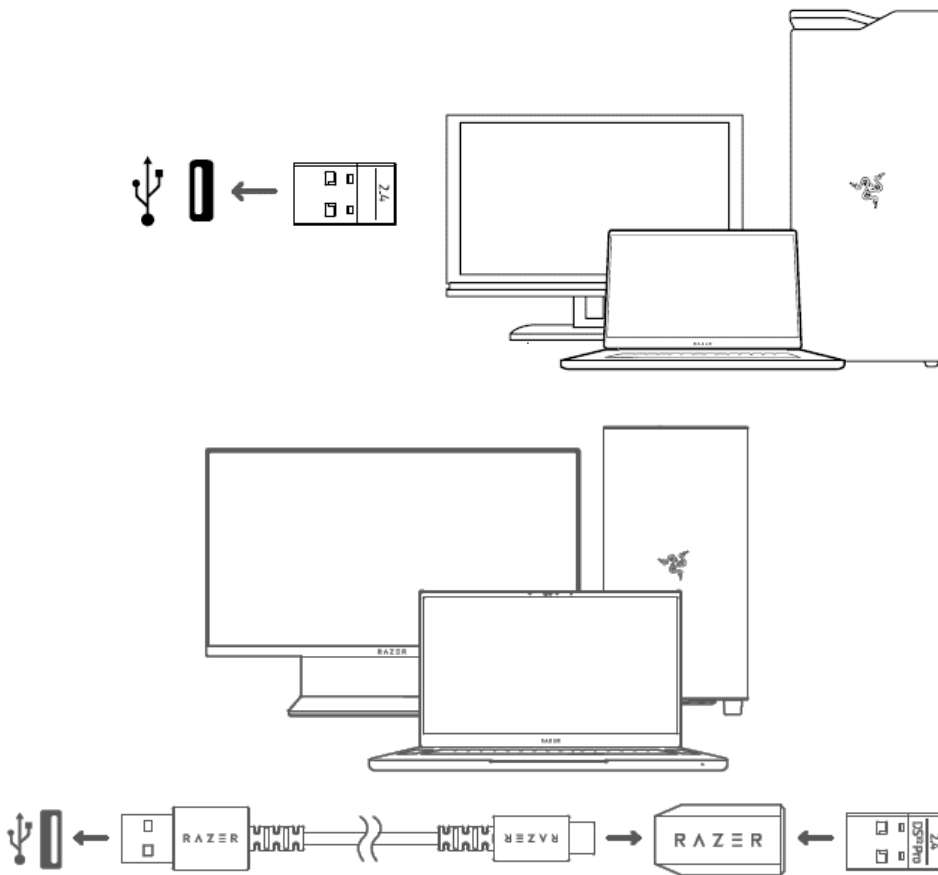





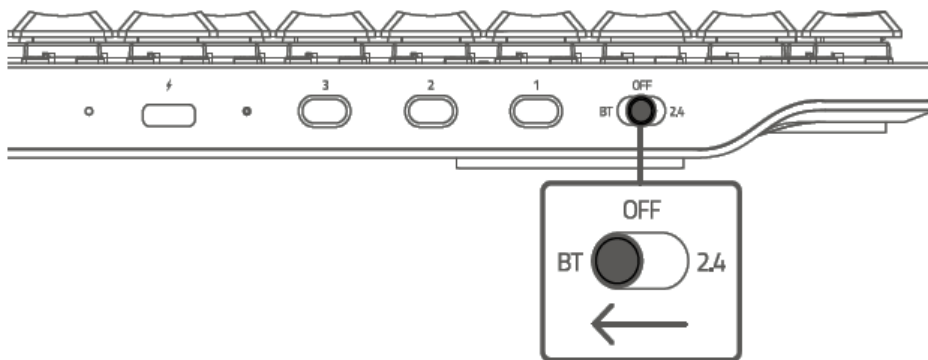

i If you have a compatible Razer device with 2.4GHz wireless connectivity, you can do a multi-device pairing and use the same dongle for both devices. Visit this link to learn more about multi-device pairing: <https://rZR.to/NAV6xO>

BT mode

1. Set the mode switch to BT.



2. Up to 3 Bluetooth devices can be paired and registered to your keyboard (one for each profile). To activate the pairing mode of your preferred profile, press and hold its corresponding button for 5 seconds. The numerical key on your keyboard will then light up to show which profile has been activated.

Button	Profile	Status
1 	Profile 1	
2 	Profile 2	
3 	Profile 3	

3. Enable Bluetooth on your device and select Razer DeathStalker V2 Pro from the list of devices found. The device will pair with your keyboard and the connection will be registered on the active profile.

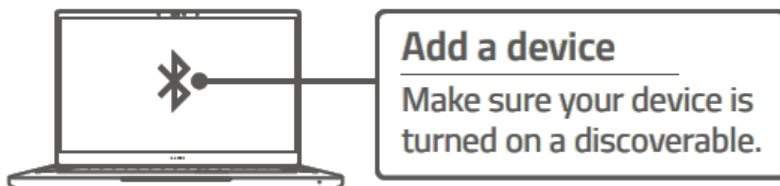

i Your keyboard will reconnect to the last paired device after it has been powered on again.

Displaying the active profile

The LED indicators will display which profile is currently active while the FN key is pressed.

Switching between profiles

To switch between any of the Bluetooth profiles available on your keyboard, simply press the corresponding button of the profile your device is registered to.

Bluetooth Reconnection

If your system was restarted, press any key (except FN) on your keyboard to reconnect to the last paired device.

Wired Mode

1. Set the mode switch to OFF.

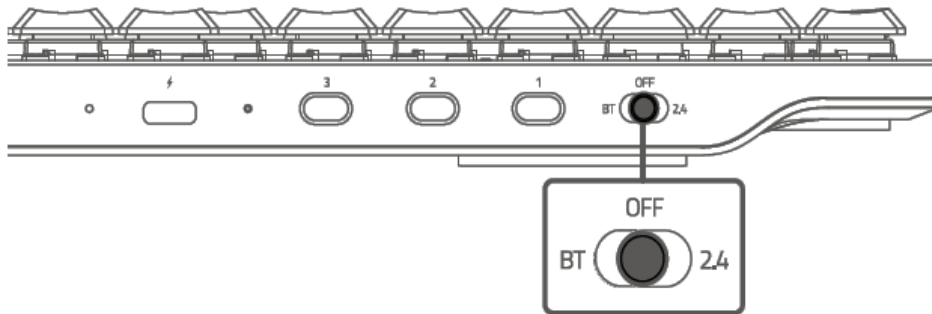

2. Connect your Razer device to the USB port of your computer.

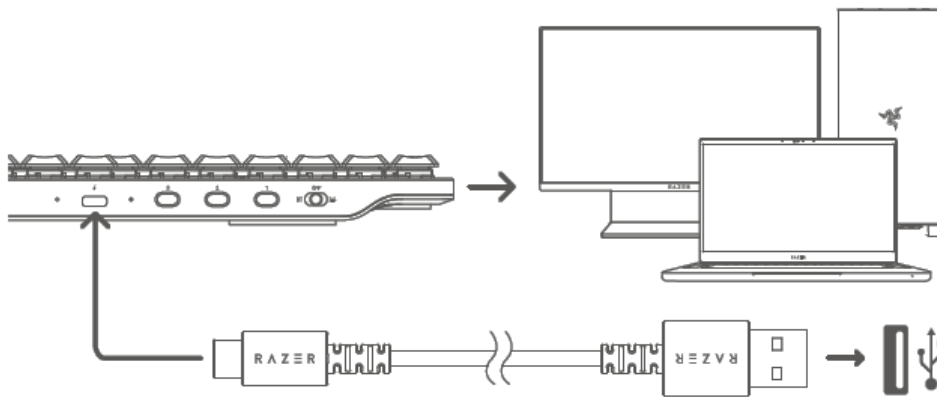

i Install Razer Synapse when prompted or download the installer from razer.com/synapse.

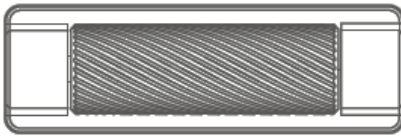

6. USING YOUR RAZER DEATHSTALKER V2 PRO

MEDIA CONTROLS

	Press once to play/pause the current track (▶)
	Press twice to go to the next track (▶▶)
	Press thrice to go back to the previous track (◀◀)
	Roll up to increase the volume (▶)))
	Roll down to decrease the volume (▶)
	Push down to mute/unmute (▶✕).

KEYBOARD FUNCTIONS

Pressing the “FN” modifier key plus keys with 2 functions will activate their secondary functions.

Function Keys	Features Description
	The backlight control keys allow you to decrease (◡◡◡) or increase (◡◡◡) the brightness of your keyboard’s LEDs.
	The sleep key allows you to suspend all operating system activities. This function allows you to save electricity while the computer is idle.

ON-THE-FLY MACRO RECORDING



Follow these steps to create an OTF Macro Recording:

1. Press the key combination to start recording.
2. The OTF Macro record key will light up to show that the device is ready to record.
3. Type the keys you want to record.
4. Press the key combination to stop the recording or the ESC key to cancel recording. The OTF Macro record key will start blinking to show that the device has stopped recording and is ready to save.
5. Press the desired Macro key where you want to save your recording.

GAMING MODE

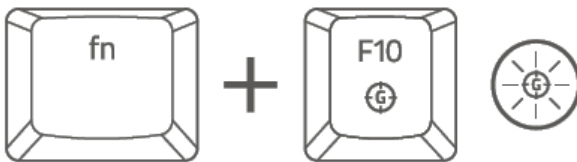

Gaming Mode disables the Windows Key, Alt+Tab, and Alt+F4 functions to avoid accidental usage. You can choose to enable the Alt+Tab and Alt+F4 functions by changing the Gaming Mode settings on Razer Synapse. The Gaming mode key will light up when it is active.

CHROMA EFFECTS

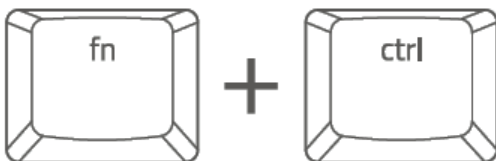

Holding down the "FN" modifier key, control key, and pressing any of the listed number keys will change the lighting on your keyboard. Below is the corresponding Chroma effect you will get for each number key.

Hotkey	Chroma Effect	Additional settings
FN + ctrl + 1	Off	N/A
FN + ctrl + 2	Static	Press the number key again to cycle through different colors
FN + ctrl + 3	Breathing	Press the number key again to cycle through different colors
FN + ctrl + 4	Spectrum cycling	N/A
FN + ctrl + 5	Wave	Press the number key again to change direction
FN + ctrl + 6	Reactive	Press the number key again to cycle through different colors
FN + ctrl + 7	Starlight	Press the number key again to cycle through different colors

Use the Razer Synapse* app to change your keyboard's lighting effect and even customize other features available on your keyboard.

Find out more about your gaming-grade keyboard at support.razer.com.

7. CONFIGURING YOUR RAZER DEATHSTALKER V2 PRO

! *Disclaimer: The features listed here require you to log into Razer Synapse 3. These features are also subject to change based on the current software version and your Operating System.*

SYNAPSE TAB

The Synapse tab is your default tab when you first launch Razer Synapse 3.

Dashboard

The Dashboard subtab is an overview of your Razer Synapse 3 where you can access all your Razer devices, modules, and online services.

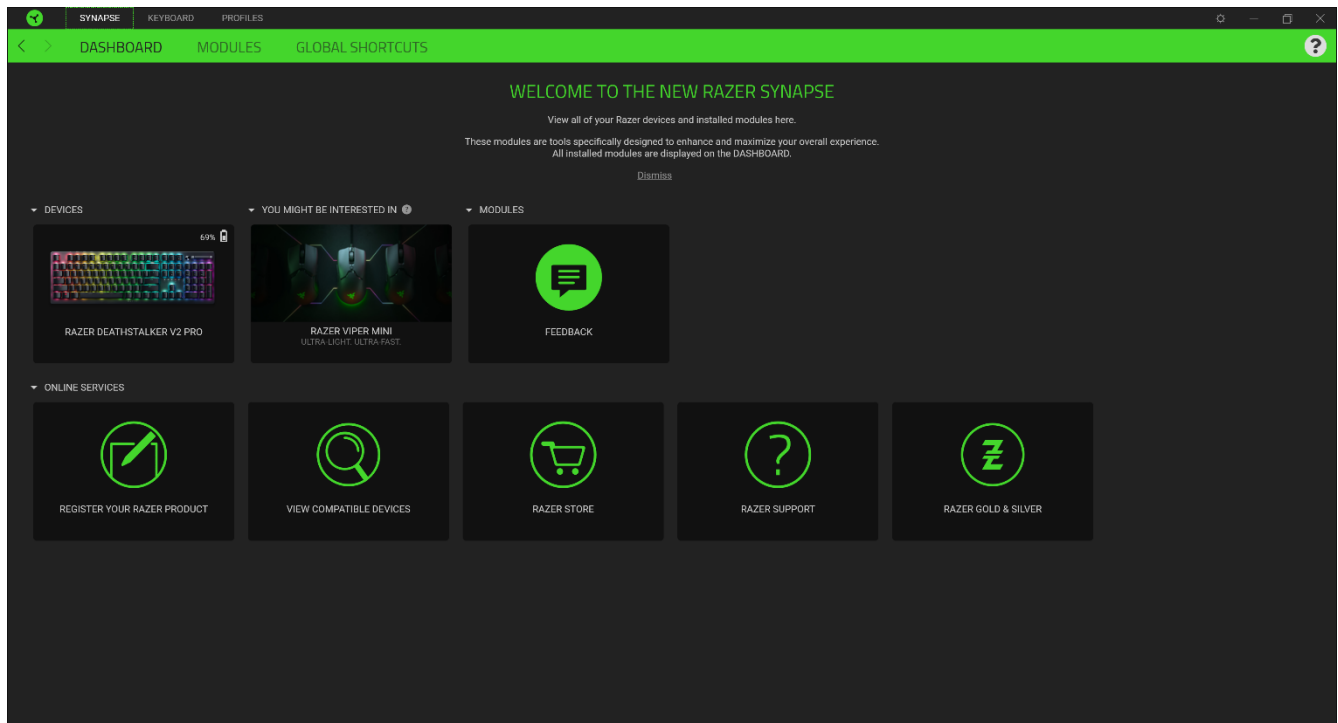

Modules

The Modules subtab displays all installed and available modules for installation.

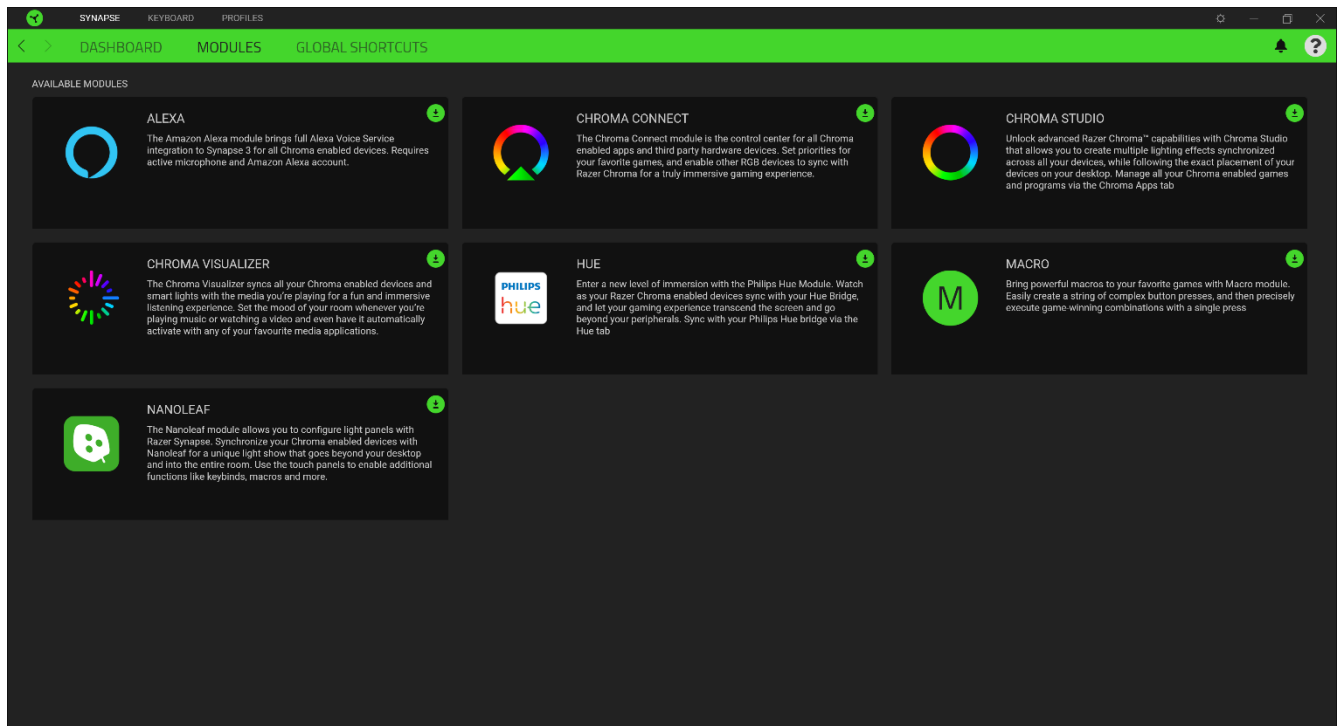

Global Shortcuts

Bind operations or Razer Synapse functions to custom key-combinations from any Razer Synapse-enabled device inputs which apply across all device profiles.

 *Only Razer Synapse-enabled device inputs will be recognized.*

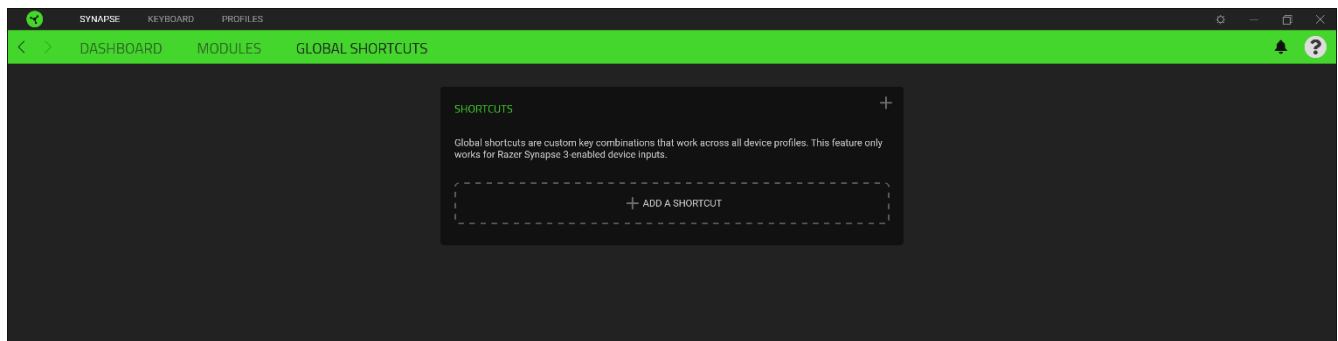

KEYBOARD

The Keyboard tab is the main tab for your Razer DeathStalker V2 Pro. From here, you can change your device settings such as key assignments, gaming mode settings, and your device's lighting. Changes made under this tab are automatically saved to your system and cloud storage.

Customize

The Customize subtab is for modifying your keyboard's key assignments and gaming mode settings.

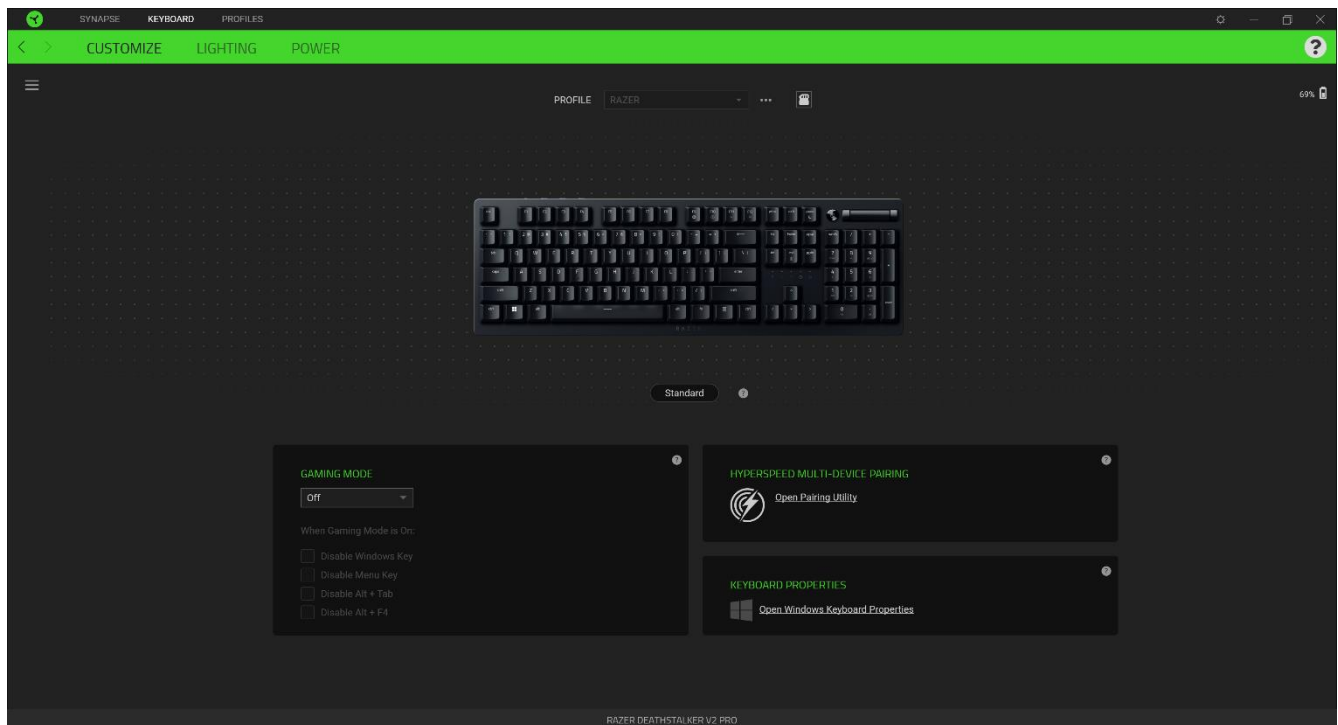

Profile

Profile is a data storage for keeping all your Razer peripheral's settings. By default, the profile name is based on your system's name. To add, import, rename, duplicate, export, or delete a profile, simply press the profile's corresponding Miscellaneous button (•••).

Hypershift

Hypershift mode is a secondary set of key assignments that is activated when the Hypershift key is held down. By default, the Hypershift key is assigned to the fn key of your Razer Synapse 3 supported keyboard however, you can also assign any key as a Hypershift key.

Gaming Mode

Gaming Mode enables you to customize which keys to disable when Gaming Mode is activated. Depending on your settings, you may choose to disable the Windows key, Alt + Tab and Alt + F4.

Keyboard Properties

Allows you to open the Windows Keyboard Properties where you can modify other keyboard settings such as Repeat delay, Repeat Rate, and Cursor blink rate, or view all keyboard drivers installed in your PC.

Keyswitch Optimization

Keyswitch Optimization allows you to choose the best setting for your analog keys. Typing mode adds a delay to prevent extra inputs while Gaming mode makes the keys hyper responsive.

HyperSpeed Multi-device Pairing

If you have a compatible Razer device with 2.4GHz wireless connectivity, you can do a multi-device pairing and use the same dongle for both devices. Visit this link to learn more about multi-device pairing: <https://rzt.to/NAV6x0>

Sidebar

Clicking the Sidebar button (☰) will reveal all current key assignments for your Razer DeathStalker V2 Pro.

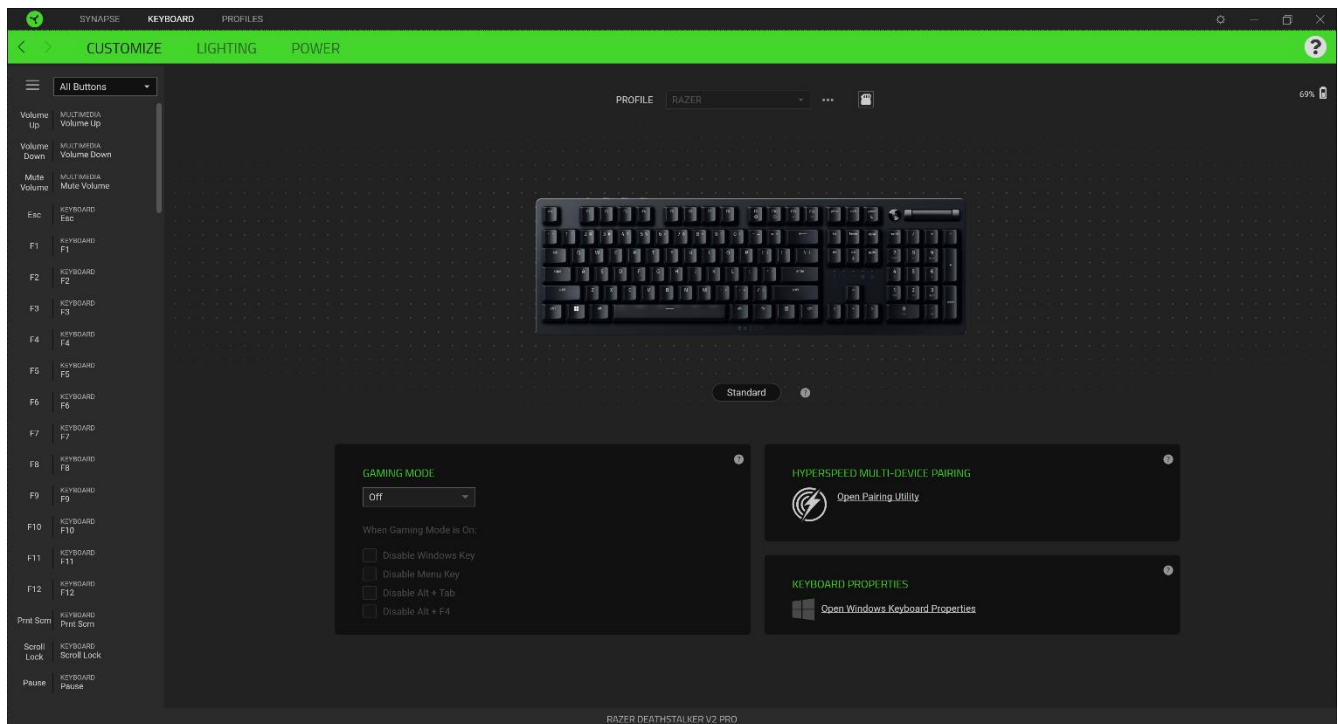

Alternatively, you can skip to a specific key assignment by selecting it on the Customize tab.

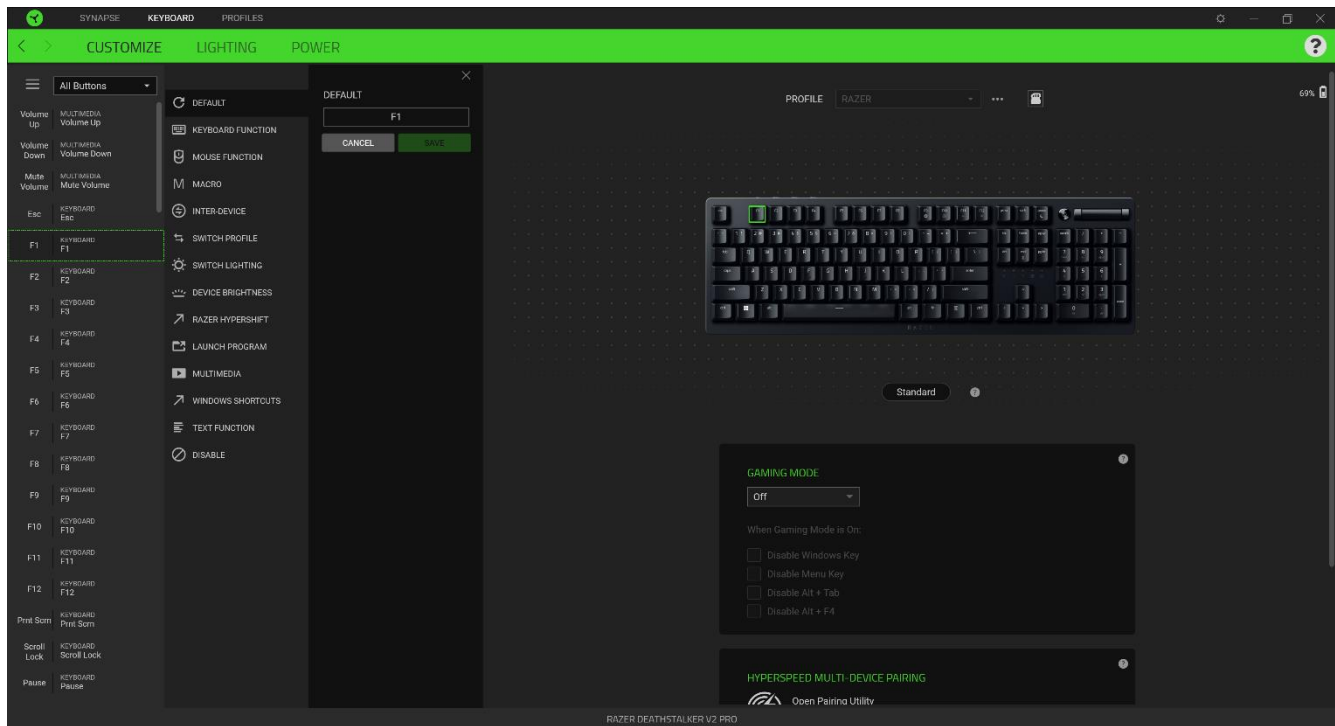

Upon selecting a key assignment, you may then change it to one of the following functions:

Default

This option enables you to return the selected key to its original setting. For analog keyboards, this option also allows you to set the actuation and release point for each key or apply the same settings for all analog keys.

Controller

This option allows you to change the functionality of any key into a controller button, bumper or trigger.

Joystick

This option enables you to change the functionality of any key into a joystick button or an analog stick direction.

Keyboard Function

This option changes the key assignment into a keyboard function. You can also choose enable Turbo mode which allows you to emulate repeatedly pressing the keyboard function while the key is held down.

Mouse Function

This option allows you to change any key into a mouse function. Listed below are the functions which you can choose from:

- Left Click - Performs a left mouse click using the assigned button.
- Right Click - Performs a right mouse click using the assigned button.
- Scroll Click - Activates the universal scrolling function.
- Double Click - Performs a double left click using the assigned button.
- Mouse Button 4 - Performs a “Backward” command for most internet browsers.
- Mouse Button 5 - Performs a “Forward” command for most internet browsers.
- Scroll Up - Performs a “Scroll Up” command using the assigned button.
- Scroll Down - Performs a “Scroll Down” command using the assigned button.
- Scroll Left - Performs a “Scroll Left” command using the assigned button.
- Scroll Right - Performs a “Scroll Right” command using the assigned button.

You can also choose to enable Turbo mode in some of the mouse functions which allow you to emulate repeatedly pressing and releasing said function while the key is held down.

Macro

A Macro is a prerecorded sequence of keystrokes and button presses that is executed with precise timing. By setting the key function to Macro, you can conveniently execute a chain of commands. Do take note that this function will only be visible if you have installed the Macro module from the Modules tab. [Click here to learn more about Macros](#)

Inter-Device

Inter-device allows you to change the settings of other Razer Synapse 3-enabled devices. Some of these functionalities are device-specific such as using your Razer gaming keyboard to change the Sensitivity Stage of your Razer gaming mouse.

Switch Profile

Switch Profile enables you to quickly change profiles and load a new set of key assignments. An on-screen notification will appear whenever you switch profiles.

Switch Lighting

Switch Lighting allows you to easily switch between all advanced lighting effects. Do take note that this function will only be visible if you have installed the Chroma module from the Modules tab.

[Click here to learn more about Advanced Chroma Effects](#)

Razer Hypershift

Setting the key to Razer Hypershift will allow you to activate Hypershift mode as long as the key is held down.

Launch Program

Launch Program enables you to open an app or a website using the assigned key. When you select Launch Program, two choices will appear which requires you to search for a specific app you want to open, or write the address of the website you want to visit.

Multimedia

This option allows you to assign multimedia controls to your Razer device. Listed below are the multimedia controls you can choose from:

- Volume Down - Decreases the audio output.
- Volume Up - Increases the audio output.
- Mute Volume - Mutes the audio.
- Mic Volume Up - Increases the microphone volume.
- Mic Volume Down - Decreases the microphone volume.
- Mute Mic - Mutes the microphone.
- Mute All - Mutes both microphone and audio output.
- Play / Pause - Play, pause, or resume playback of the current media.
- Previous Track - Play the previous media track.
- Next Track - Play the next media track.

Windows Shortcuts

This option allows you to assign your preferred key into a Windows Operating System shortcut command. For more information, please visit: support.microsoft.com/kb/126449

Text Function

Text Function enables you to type a prewritten text with a touch of a key. Simply write your desired text on the given field and your text will be typed whenever the assigned key is pressed. This function has full Unicode support and you can also insert special symbols from character maps.

Disable

This option renders the assigned key unusable. Use Disable if you do not want to use the selected key or if it interferes with your gaming.

Lighting

The Lighting subtab enables you to modify your Razer device's light settings.

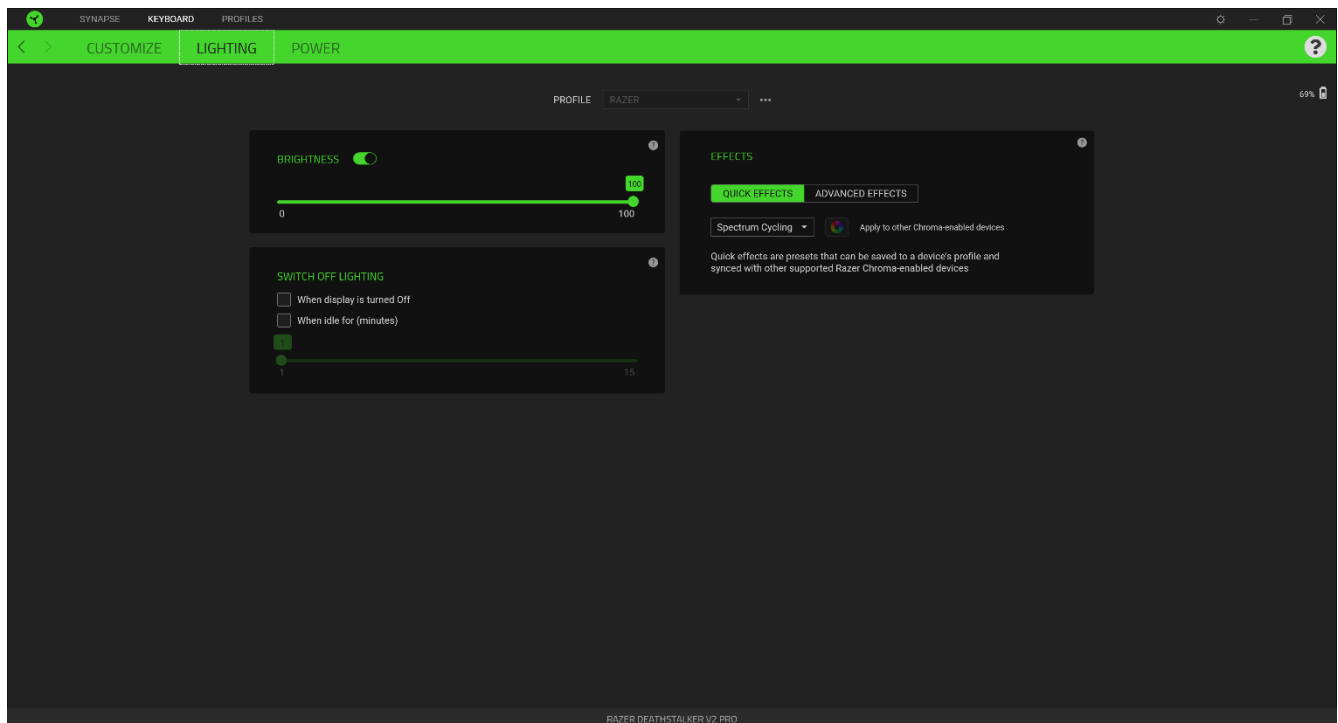

Brightness

You can turn off your Razer device's lighting by toggling the Brightness option or increase/decrease the luminance using the slider.











Switch Off Lighting

This is a power saving tool which allows you to disable your device's lighting in response to your system's display turning off and/or automatically power down when your Razer DeathStalker V2 Pro has been idle for a set amount of time.

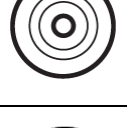
Quick Effects

A number of quick effects can be selected and applied to your device's lighting, as listed here:

i Only devices that support the selected lighting effect will synchronize. LED indicators are not customizable.

	Name	Description	How to set up
	Ambient awareness	The lighting on the keyboard will reflect the averaged color on the selected screen region	Select or customize a screen region
	Audio meter	The keyboard will light up according to the audio level with a default spectrum of colors	Select a Color Boost level
	Breathing	The keyboard fades in and out of the selected color(s)	Select up to 2 colors or randomize colors
	Fire	The keyboard lights up in warm colors to mimic the motion of flames	No further customization required
	Reactive	The LEDs will light up when a key is pressed. The light will fade off after a specified period of time	Select a color and a duration
	Ripple	On key press, light will ripple away from the pressed key	Select a color
	Spectrum cycling	The lighting will cycle between 16.8 million colors indefinitely	No further customization required
	Starlight	Each LED will have a chance of fading in and out at a random time and duration	Select up to 2 colors or randomize colors and select a duration
	Static	The LEDs will remain lit in the selected color	Select a color
	Wave	The lighting will scroll in the direction selected	Select either left-to-right or right-to-left wave direction

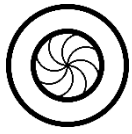

Wheel

The keyboard lighting will rotate in the direction selected with a default spectrum of colors

Select either counter-clockwise or clockwise wheel direction

If you have other supported Razer Chroma-enabled devices, you can synchronize their quick effects with your Razer device by clicking the Chroma Sync button ().

Studio Effects

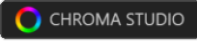
The Studio Effects option allows you to choose a Chroma Effect you want to use on your Razer Chroma-enabled peripheral. To start making your own Chroma Effect, simply press the Chroma Studio button (). [Click here to learn more about the Chroma Studio](#)

Power

The Power subtab allows you to manage your device's energy consumption when running on batteries.

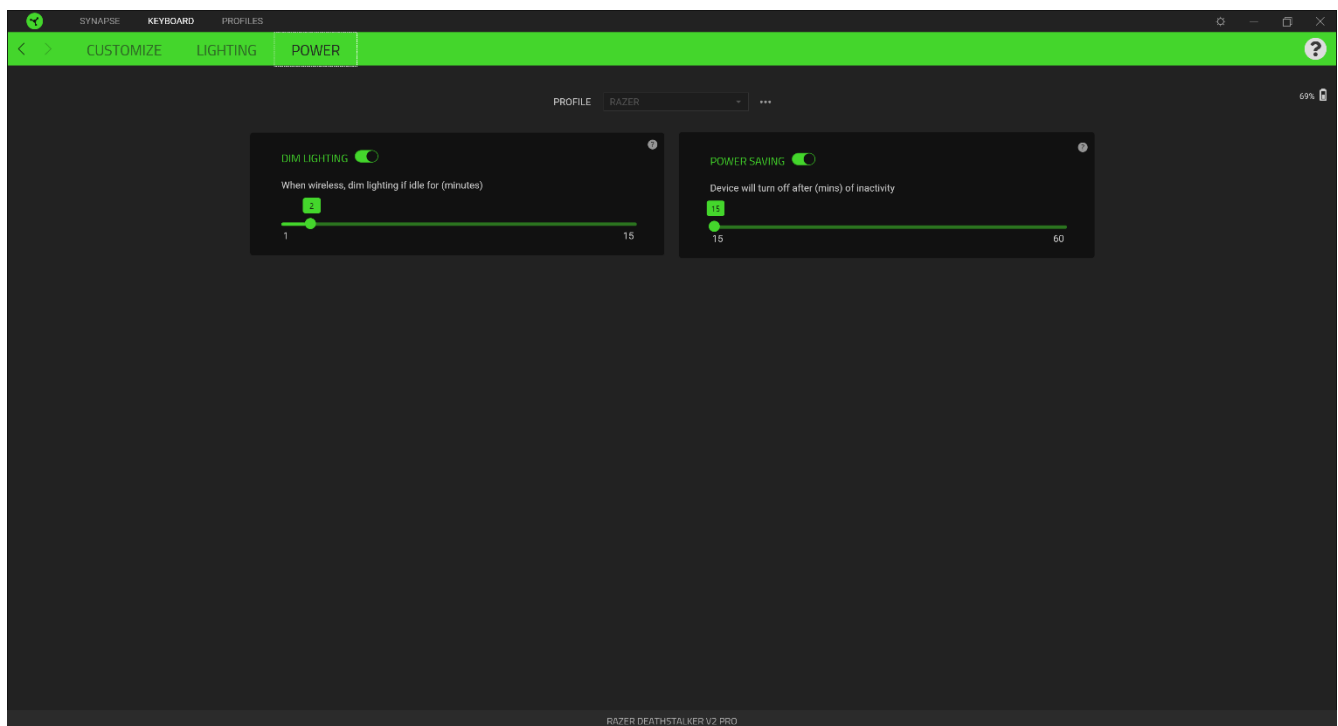

Dim Lighting

Set how long your device should be idle before it lowers its brightness.

Wireless Power Saving

Set your device to enter sleep mode when it has been idle for a certain amount of time.



PROFILES TAB

The Profiles tab is a convenient way of managing all your profiles and linking them to your games and applications.

Devices

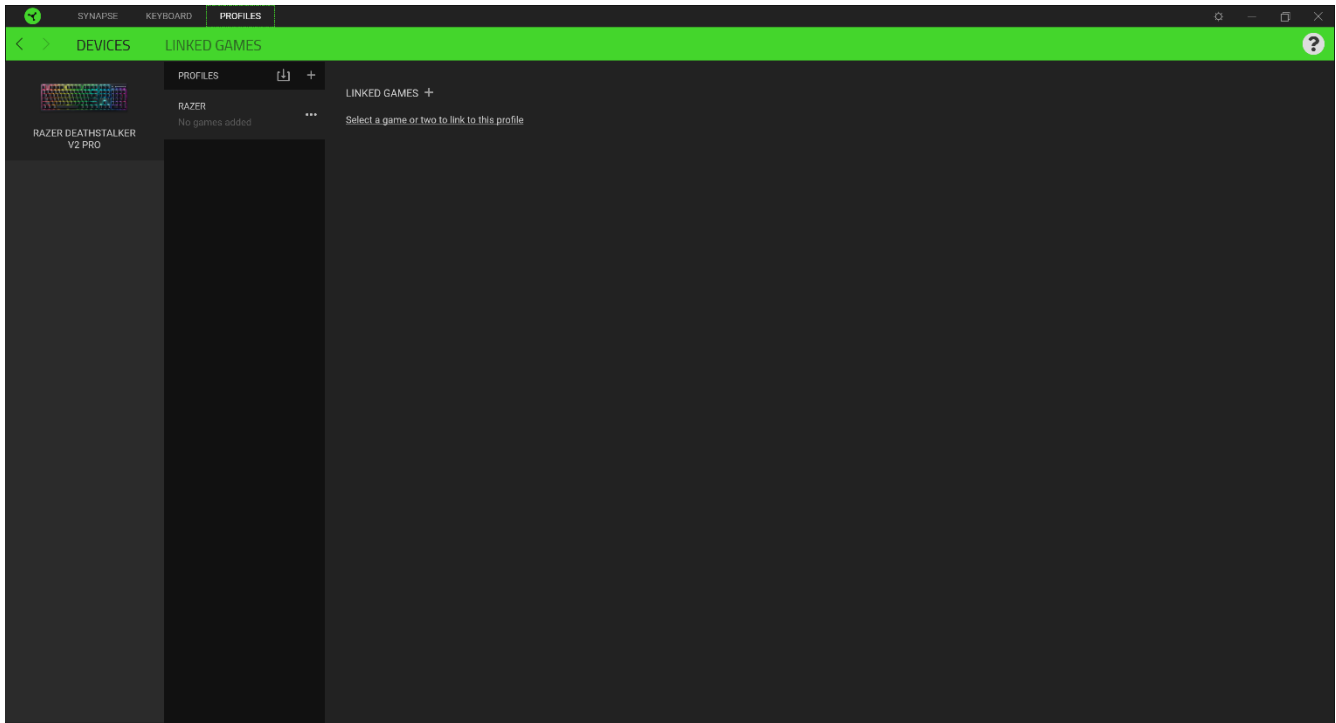
View which games are linked to each device's profiles or which Chroma Effect is linked to specific games using the Devices subtab.



You can import Profiles / Chroma Effects from your computer or from the cloud through the import button (), or create new profiles within the selected device or new Chroma Effects for specific games using the add button (). To rename, duplicate, export, or delete a profile, simply press the Miscellaneous button (). Each profile and/or Chroma Effect can be set to automatically activate when you run an application using the Linked Games option.

Linked Games

The Linked Games subtab gives you the flexibility to add games, view peripherals that are linked to games, or search for added games. You can also sort games based on alphabetical order, last played, or most played. Added games will still be listed here even if it is not linked to a Razer device.

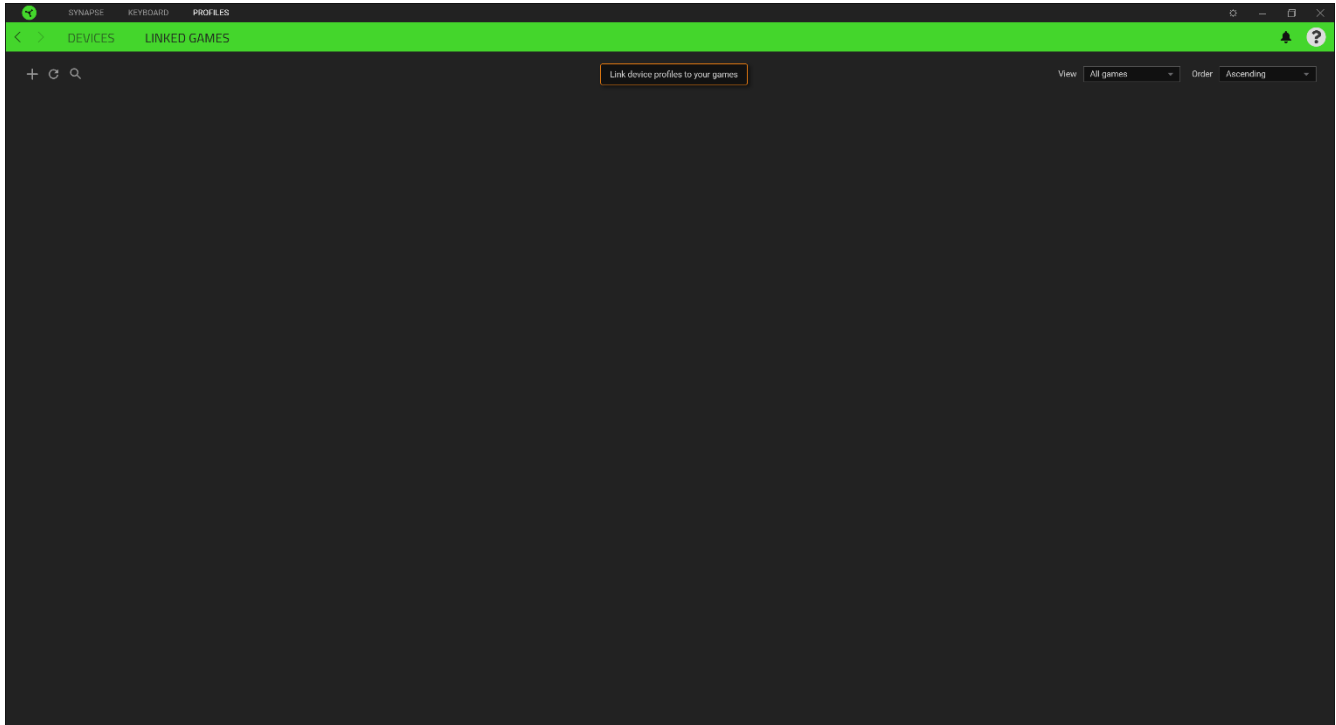

To link games to connected Razer devices or Chroma Effects, simply click on any game from the list, and then click **Select a device and its profile to launch automatically during gameplay** to select the Razer device or Chroma Effect it will link with.

Once linked, you may click on the Miscellaneous button (●●●) of the corresponding Chroma Effect or device to select a specific Chroma Effect or profile.

SETTINGS WINDOW

The Settings window, accessible by clicking the () button on Razer Synapse 3, enables you to configure the startup behavior and display language of Razer Synapse 3, view the master guides of each connected Razer device, or perform factory reset on any connected Razer device.

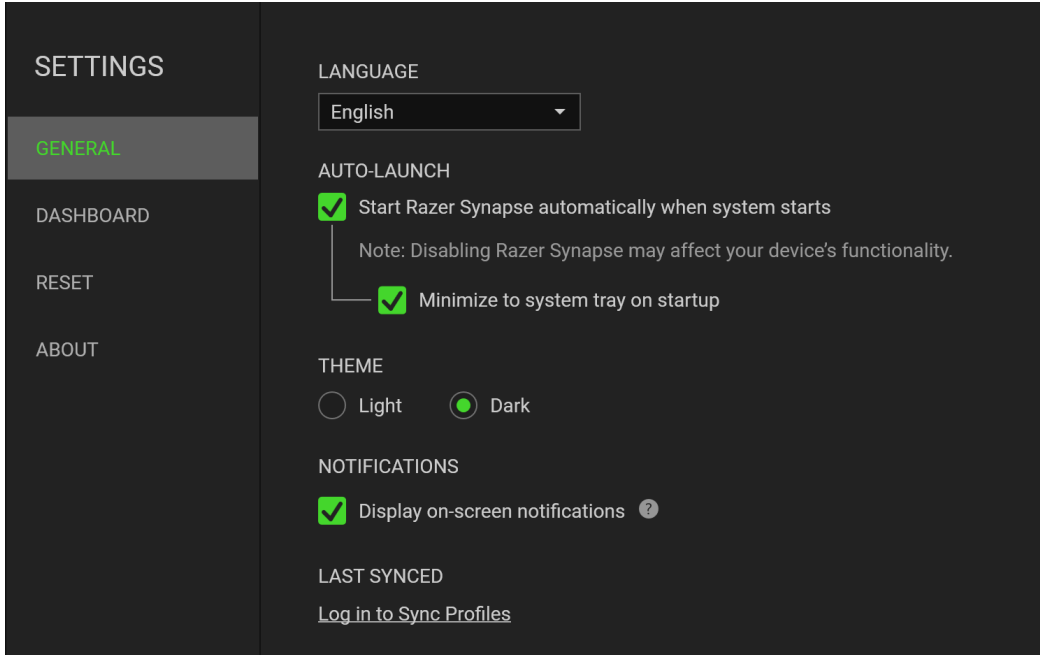

General tab

The default tab of the Settings window. The General tab enables you to change the software's display language, start-up behavior, and display theme; or view the master guide of all connected Razer devices. You may also manually sync your profiles to the cloud () or view the master guide of all connected Razer devices.

Reset tab

The Reset tab allows you to perform a factory reset on all connected Razer devices with on-board memory and/or reset Razer Synapse 3 tutorials to acquaint yourself again with Razer Synapse 3's new features on its next launch.

 *By resetting a Razer device, all profiles stored on the selected device's on-board memory will be erased.*

About tab

The About tab displays brief software information, copyright statement, and provides relevant links for its terms of use. You may also use this tab to check for software updates, or as a quick access to Razer's social communities.

8. SAFETY AND MAINTENANCE

SAFETY GUIDELINES

In order to achieve maximum safety while using your Razer DeathStalker V2 Pro, we suggest that you adopt the following guidelines:

Should you have trouble operating the device properly and troubleshooting does not work, unplug the device and contact the Razer hotline or go to support.razer.com for support.

Do not take apart the device (doing so will void your warranty) and do not attempt to operate it under abnormal current loads.

Keep the device away from liquid, humidity or moisture. Operate the device only within the specific temperature range of 0°C (32°F) to 40°C (104°F). Should the temperature exceed this range, unplug and/or switch off the device in order to let the temperature stabilize to an optimal level.

COMFORT

Research has shown that long periods of repetitive motion, improper positioning of your computer peripherals, incorrect body position, and poor habits may be associated with physical discomfort and injury to nerves, tendons, and muscles. Below are some guidelines to avoid injury and ensure optimum comfort while using your Razer DeathStalker V2 Pro.

1. Position your keyboard and monitor directly in front of you with your mouse next to it. Place your elbows next to your side, not too far away and your keyboard within easy reach.
2. Adjust the height of your chair and table so that the keyboard and mouse are at or below elbow height.
3. Keep your feet well supported, posture straight and your shoulders relaxed.
4. During gameplay, relax your wrist and keep it straight. If you do the same tasks with your hands repeatedly, try not to bend, extend or twist your hands for long periods.
5. Do not rest your wrists on hard surfaces for long periods.
6. Use a wrist rest to support your wrist while gaming.
7. Customize the keys on your keyboard to suit your style of gaming in order to minimize repetitive or awkward motions while gaming.
8. Do not sit in the same position all day. Get up, step away from your desk and do exercises to stretch your arms, shoulders, neck and legs.

If you should experience any physical discomfort while using your keyboard, such as pain, numbness, or tingling in your hands, wrists, elbows, shoulders, neck or back, please consult a qualified medical doctor immediately.

MAINTENANCE AND USE

The Razer DeathStalker V2 Pro requires minimum maintenance to keep it in optimum condition. Once a month we recommend you unplug the device from the computer and clean it using a soft cloth or cotton swab to prevent dirt buildup. Do not use soap or harsh cleaning agents.

9. LEGALESE

COPYRIGHT AND INTELLECTUAL PROPERTY INFORMATION

©2022 Razer Inc. All rights reserved. Razer, the triple-headed snake logo, Razer logo, “For Gamers. By Gamers.”, and “Powered by Razer Chroma” logo are trademarks or registered trademarks of Razer Inc. and/or affiliated companies in the United States or other countries. All other trademarks are the property of their respective owners.

Windows and the Windows logo are trademarks of the Microsoft group of companies.

Razer Inc. (“Razer”) may have copyright, trademarks, trade secrets, patents, patent applications, or other intellectual property rights (whether registered or unregistered) concerning the product in this guide. Furnishing of this guide does not give you a license to any such copyright, trademark, patent or other intellectual property right. The Razer DeathStalker V2 Pro (the “Product”) may differ from pictures whether on packaging or otherwise. Razer assumes no responsibility for such differences or for any errors that may appear. Information contained herein is subject to change without notice.

LIMITED PRODUCT WARRANTY

For the latest and current terms of the Limited Product Warranty, please visit razer.com/warranty.

LIMITATION OF LIABILITY

Razer shall in no event be liable for any lost profits, loss of information or data, special, incidental, indirect, punitive or consequential or incidental damages, arising in any way out of distribution of, sale of, resale of, use of, or inability to use the Product. In no event shall Razer’s liability exceed the retail purchase price of the Product.

GENERAL

These terms shall be governed by and construed under the laws of the jurisdiction in which the Product was purchased. If any term herein is held to be invalid or unenforceable, then such term (in so far as it is invalid or unenforceable) shall be given no effect and deemed to be excluded without invalidating any of the remaining terms. Razer reserves the right to amend any term at any time without notice.

Ovaj dokument je originalno proizveden i objavljen od strane proizvođača, brenda Razer, i preuzet je sa njihove zvanične stranice. S obzirom na ovu činjenicu, Tehnoteka ističe da ne preuzima odgovornost za tačnost, celovitost ili pouzdanost informacija, podataka, mišljenja, saveta ili izjava sadržanih u ovom dokumentu.

Napominjemo da Tehnoteka nema ovlašćenje da izvrši bilo kakve izmene ili dopune na ovom dokumentu, stoga nismo odgovorni za eventualne greške, propuste ili netačnosti koje se mogu naći unutar njega. Tehnoteka ne odgovara za štetu nanесenu korisnicima pri upotrebi netačnih podataka. Ukoliko imate dodatna pitanja o proizvodu, ljubazno vas molimo da kontaktirate direktno proizvođača kako biste dobili sve detaljne informacije.

Za najnovije informacije o ceni, dostupnim akcijama i tehničkim karakteristikama proizvoda koji se pominje u ovom dokumentu, molimo posetite našu stranicu klikom na sledeći link:

<https://tehnoteka.rs/p/razer-bezicna-tastatura-deathstalker-v2-pro-linear-crna-akcija-cena/>