

Uputstvo za upotrebu

BEKO ugradni set BSE24322B

The Beko logo is displayed in a bold, blue, sans-serif font. Below the text is a thick, blue diagonal bar that starts under the 'b' and extends towards the right, ending under the 'o'.

Tehnoteka je online destinacija za upoređivanje cena i karakteristika bele tehnike, potrošačke elektronike i IT uređaja kod trgovinskih lanaca i internet prodavnica u Srbiji. Naša stranica vam omogućava da istražite najnovije informacije, detaljne karakteristike i konkurentne cene proizvoda.

Posetite nas i uživajte u ekskluzivnom iskustvu pametne kupovine klikom na link:

<https://tehnoteka.rs/p/beko-ugradni-set-bse24322b-akcija-cena/>



Built-in Oven

User Manual

Ugradna pećnica

Korisnički priručnik

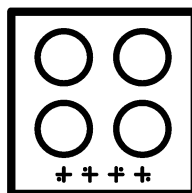
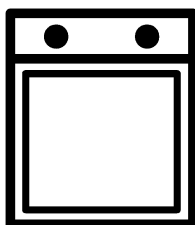

BIM24302B

EN / SB

285.4460.66/R.AC/20.05.2020/3-1

7751788321

Please read this user manual first!

Dear Customer,

Thank you for purchasing this Beko product. We hope that you get the best results from your product which has been manufactured with high quality and state-of-the-art technology. Therefore, please read this entire user manual and all other accompanying documents carefully before using the product and keep it as a reference for future use. If you handover the product to someone else, give the user manual as well. Follow all warnings and information in the user manual.

Remember that this user manual is also applicable for several other models. Differences between models will be identified in the manual.

Explanation of symbols

Throughout this user manual the following symbols are used:



Important information or useful hints about usage.



Warning of hazardous situations with regard to life and property.



Warning of electric shock.



Warning of risk of fire.



Warning of hot surfaces.



Arçelik A.Ş.
Karaağaç caddesi No:2-6
34445 Sütlüce/İstanbul/TURKEY
Made in TURKEY

This product was manufactured using the latest technology in environmentally friendly conditions.

TABLE OF CONTENTS

1 Important instructions and warnings for safety and environment 4

General safety	4
Electrical safety.....	5
Product safety	6
Intended use	8
Safety for children.....	8
Disposing of the old product	8
Package information	9

2 General information 10

Overview	10
Package contents.....	11
Technical specifications	12

3 Installation 13

Before installation	13
Installation and connection	15
Future Transportation.....	17

4 Preparation 19

Tips for saving energy	19
Initial use	19
Time setting.....	19

First cleaning of the appliance.....20

5 How to operate the oven 21

General information on baking, roasting and grilling	21
How to operate the electric oven	22
Operating modes.....	22
Using the oven clock.....	23
Cooking times table	26
How to operate the grill	30
Cooking times table for grilling	30

6 Maintenance and care 31

General information.....	31
Cleaning the control panel.....	31
Cleaning the oven	31
Removing the oven door	32
Removing the door inner glass	33
Replacing the oven lamp	34

7 Troubleshooting 35

1 Important instructions and warnings for safety and environment

This section contains safety instructions that will help protect from risk of personal injury or property damage. Failure to follow these instructions shall void any warranty.

General safety

- This appliance can be used by children aged from 8 years and above and persons with reduced physical, sensory or mental capabilities or lack of experience and knowledge if they have been given supervision or instruction concerning use of the appliance in a safe way and understand the hazards involved.
Children shall not play with the appliance. Cleaning and user maintenance shall not be made by children without supervision.
- The appliance is not to be used by persons (including children) with reduced physical, sensory or mental capabilities, or lack of experience and knowledge, unless they have been given supervision or instruction. Children should be supervised and ensure they do not play with the appliance
- If the product is handed over to someone else for personal use or second-hand use purposes, the user manual, product labels and other relevant documents and parts should be also given.
- Installation and repair procedures must always be performed by Authorised Service Agents. The manufacturer shall not be held responsible for damages arising from procedures carried out by unauthorised persons which may also void the warranty. Before installation, read the instructions carefully.
- Do not operate the product if it is defective or has any visible damage.
- Ensure that the product function knobs are switched off after every use.

Electrical safety

- If the product has a failure, it should not be operated unless it is repaired by an Authorised Service Agent. There is the risk of electric shock!
- Only connect the product to a grounded outlet/line with the voltage and protection as specified in the “Technical specifications”. Have the grounding installation made by a qualified electrician while using the product with or without a transformer. Our company shall not be liable for any problems arising due to the product not being earthed in accordance with the local regulations.
- Never wash the product by spreading or pouring water onto it! There is the risk of electric shock!
- The product must be disconnected during installation, maintenance, cleaning and repairing procedures.
- If the power connection cable for the product is damaged, it must be replaced by the manufacturer, its service agent or similarly qualified persons in order to avoid a hazard.
- The appliance must be installed so that it can be completely disconnected from the mains supply. The separation must be provided by a switch built into the fixed electrical installation, according to construction regulations.
- Rear surface of the oven gets hot when it is in use. Make sure that the electrical connection does not contact with the rear surface; otherwise, connections can get damaged.
- Do not trap the mains cable between the oven door and frame and do not route it over hot surfaces. Otherwise, cable insulation may melt and cause fire as a result of short circuit.
- Any work on electrical equipment and systems should only be carried out by authorised and qualified persons.
- In case of any damage, switch off the product and disconnect it from the mains. To do this, turn off the fuse at home.

- Make sure that fuse rating is compatible with the product.

Product safety

- **WARNING:** The appliance and its accessible parts become hot during use. Care should be taken to avoid touching heating elements. Children less than 8 years of age shall be kept away unless continuously supervised.
- Never use the product when your judgment or coordination is impaired by the use of alcohol and/or drugs.
- Be careful when using alcoholic drinks in your dishes. Alcohol evaporates at high temperatures and may cause fire since it can ignite when it comes into contact with hot surfaces.
- Food Poisoning Hazard: Do not let food sit in oven for more than 1 hour before or after cooking. Doing so can result in food poisoning or sickness.
- Do not place any flammable materials close to the product as the sides may become hot during use.
- During use the appliances becomes hot. Care should be taken to avoid touching heating elements inside the oven.
- Keep all ventilation slots clear of obstructions.
- Do not heat closed tins and glass jars in the oven. The pressure that would build-up in the tin/jar may cause it to burst.
- Do not place baking trays, dishes or aluminium foil directly onto the bottom of the oven. The heat accumulation might damage the bottom of the oven.
- Do not use harsh abrasive cleaners or sharp metal scrapers to clean the oven door glass since they can scratch the surface, which may result in shattering of the glass.
- Do not use steam cleaners to clean the appliance as this may cause an electric shock.
- **(Varies depending on the product model.)**
Placing the wire shelf and tray onto the wire racks properly
It is important to place the wire shelf and/or tray onto

the rack properly. Slide the wire shelf or tray between 2 rails and make sure that it is balanced before placing food on it (Please see the following figure).

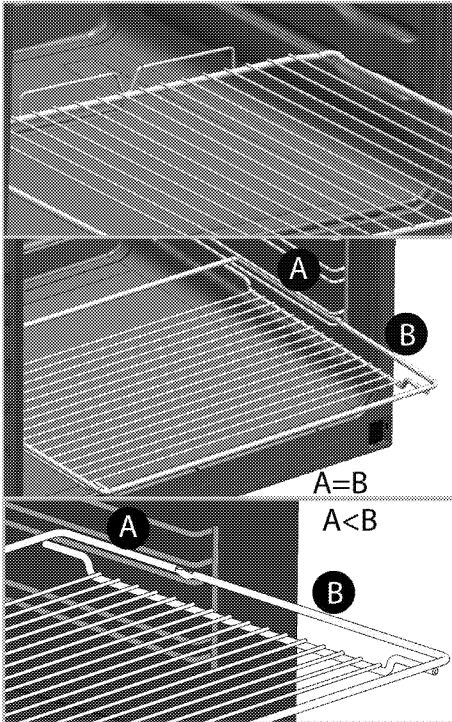

- Do not use the product if the front door glass is removed or cracked.
- Always use heat resistant oven gloves when putting in or removing dishes into/from the hot oven.
- Place the baking paper into the cooking pot or on to the oven accessory (tray, wire grill etc) together with the

food and then insert all into the preheated oven. Remove the excess parts of the baking paper overflowing from the accessory or the pot in order to prevent the risk of touching the oven's heating elements. Never use the baking paper in an operating temperature higher than the indicated value for the baking paper. Do not place the baking paper directly on the base of the oven.

- **WARNING:** Ensure that power cord of the appliance is unplugged or circuit breaker is switched off before replacing the lamp to avoid the possibility of electric shock.
- The appliance must not be installed behind a decorative door in order to avoid overheating.

Prevention against possible fire risk!

- Ensure all electrical connections are secure and tight to prevent risk of arcing.
- Do not use damaged cables or extension cables.
- Ensure liquid or moisture is not accessible to the electrical connection point.

Intended use

- This product is designed for domestic use. Commercial use will void the guarantee.
- **CAUTION:** This appliance is for cooking purposes only. It must not be used for other purposes, for example room heating.
- This product should not be used for warming the plates under the grill, drying towels, dish cloths etc. by hanging them on the oven door handles. This product should also not be used for room heating purposes.
- The manufacturer shall not be liable for any damage caused by improper use or handling errors.
- The oven can be used for defrosting, baking, roasting and grilling food.

Safety for children

- **WARNING:** Accessible parts may become hot during use. Young children should be kept away.
- The packaging materials will be dangerous for children. Keep the packaging materials away from children. Please dispose of all parts of the

packaging according to environmental standards.

- Electrical products are dangerous to children. Keep children away from the product when it is operating and do not allow them to play with the product.
- Do not place any items above the appliance that children may reach for.
- When the door is open, do not load any heavy object on it and do not allow children to sit on it. It may overturn or door hinges may get damaged.

Disposing of the old product

Compliance with the WEEE Directive and Disposing of the Waste Product:



This product complies with EU WEEE Directive (2012/19/EU). This product bears a classification symbol for waste electrical and electronic equipment (WEEE).

This product has been manufactured with high quality parts and materials which can be reused and are suitable for recycling. Do not dispose of the waste product with normal domestic and other wastes at the end of its service life. Take it to the collection center for the recycling of electrical and electronic equipment. Please consult your local authorities to learn about these collection centers.

Compliance with RoHS Directive:

The product you have purchased complies with EU RoHS Directive (2011/65/EU). It does not contain harmful and prohibited materials specified in the Directive.

Package information

- Packaging materials of the product are manufactured from recyclable

materials in accordance with our National Environment Regulations. Do not dispose of the packaging materials together with the domestic or other wastes. Take them to the packaging material collection points designated by the local authorities.

2 General information

Overview

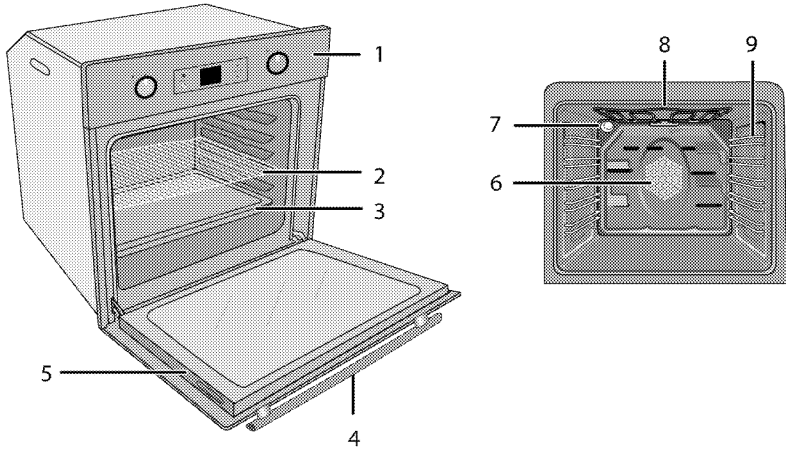

- 1 Control panel
- 2 Wire shelf
- 3 Tray
- 4 Handle
- 5 Door

- 6 Fan motor (behind steel plate)
- 7 Lamp
- 8 Top heating element
- 9 Shelf positions

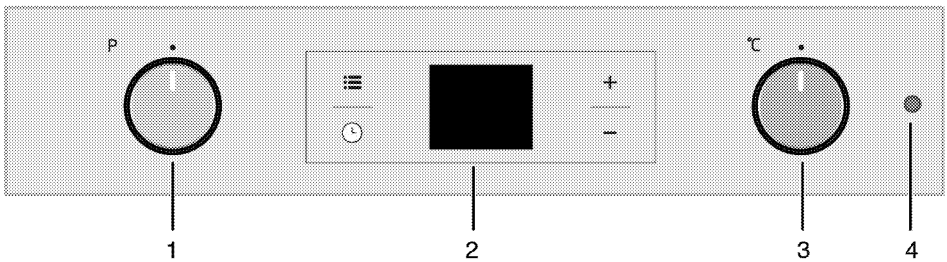

- 1 Function knob
- 2 Digital timer
- 3 Thermostat knob
- 4 Thermostat lamp

Package contents

i Accessories supplied can vary depending on the product model. Not every accessory described in the user manual may exist on your product.

1. User manual

2. Standard tray

Used for pastries, frozen foods and big roasts.

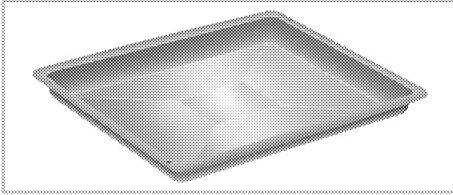

3. Wire grill

Used for roasting and for placing the food to be baked, roasted or cooked in casserole dishes to the desired rack.

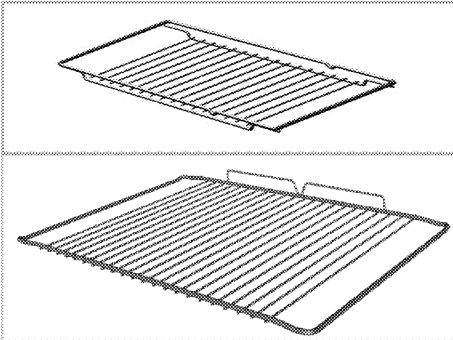

4. Placing the wire shelf and tray onto the telescopic racks properly (This feature is optional. It may not exist on your product.)

Telescopic racks allow you to install and remove the trays and wire shelf easily.

When using the tray and wire shelf with telescopic racks, make sure that the pins at the rear section of the telescopic rack stands against the edges of the wire shelf and tray.

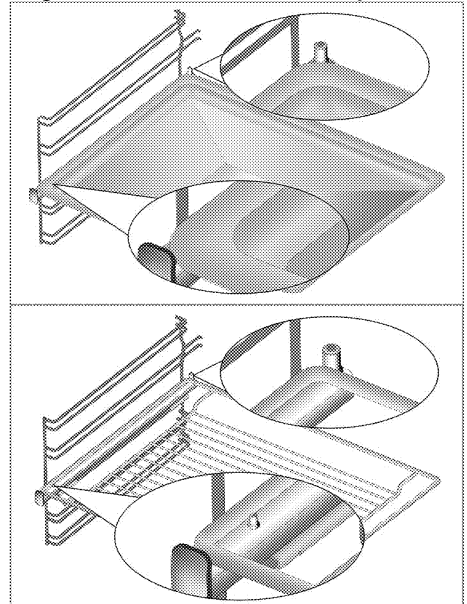

Technical specifications

Voltage / frequency	220-240 V~ 50 Hz
Total power consumption	2.5 kW
Cable type / section	min.H05VV-FG 3 x 1,5 mm ²
External dimensions (height / width / depth)	595 mm/594 mm/567 mm
Installation dimensions (height / width / depth)	**590 or 600 mm/560 mm/min. 550 mm
Main oven	Multifunction oven
Inner lamp	15/25 W
Grill power consumption	2.2 kW

Basics: Information on the energy label of electrical ovens is given in accordance with the EN 60350-1 / IEC 60350-1 standard. Those values are determined under standard load with bottom-top heater or fan assisted heating (if any) functions.

Energy efficiency class is determined in accordance with the following prioritization depending on whether the relevant functions exist on the product or not. 1-Cooking with eco-fan, 2- Turbo slow cooking, 3- Turbo cooking, 4- Fan assisted bottom/top heating, 5-Top and bottom heating.

** See. *Installation*, page 13.

i Technical specifications may be changed without prior notice to improve the quality of the product.

i Figures in this manual are schematic and may not exactly match your product.

i Values stated on the product labels or in the documentation accompanying it are obtained in laboratory conditions in accordance with relevant standards. Depending on operational and environmental conditions of the product, these values may vary.

3 Installation

Product must be installed by a qualified person in accordance with the regulations in force. The manufacturer shall not be held responsible for damages arising from procedures carried out by unauthorized persons which may also void the warranty.

 Preparation of location and electrical installation for the product is under customer's responsibility.

 The product must be installed in accordance with all local electrical regulations.

 Prior to installation, visually check if the product has any defects on it. If so, do not have it installed. Damaged products cause risks for your safety.

Before installation

The appliances must not be installed behind a decorative door in order to avoid overheating.

The appliance is intended for installation in commercially available kitchen cabinets. A safety distance must be left between the appliance and the kitchen walls and furniture. See figure (values in mm).

- Surfaces, synthetic laminates and adhesives used must be heat resistant (100 °C minimum).
- Kitchen cabinets must be set level and fixed.
- If there is a drawer beneath the oven, a shelf must be installed in order to separate from the oven and drawer.
- Carry the appliance with at least two persons.
- Hold the oven from the slots for handling on both sides to move it.
- Before installing the product, remove all materials and documents inside.
- Kitchen furniture must be in compliance with the dimensions given in the figure below. At the rear section of the kitchen furniture, an opening must be cut out with the dimensions given in the figure below to ensure sufficient ventilation.
-  Do not install the appliance next to refrigerators or freezers. The heat emitted by the appliance will lead to an increased energy consumption of cooling appliances.
-  The door and/or handle must not be used for lifting or moving the appliance.

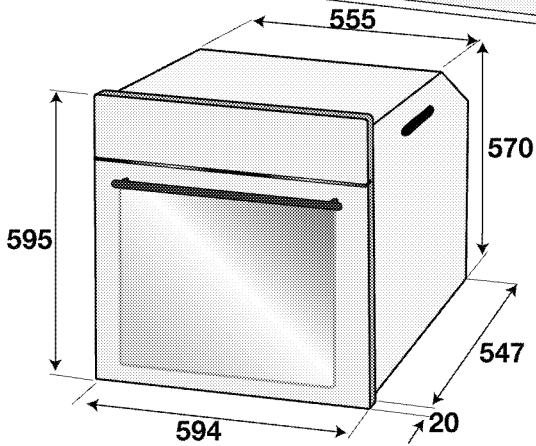
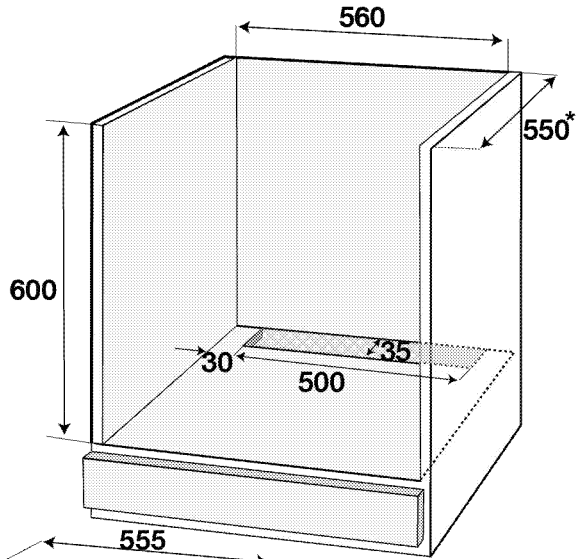
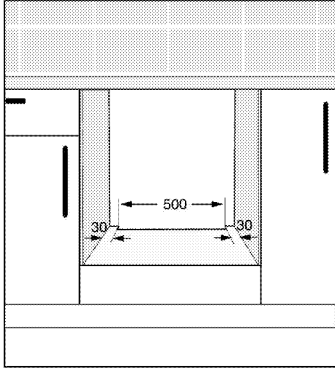
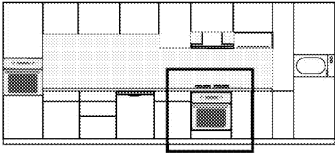

* min.

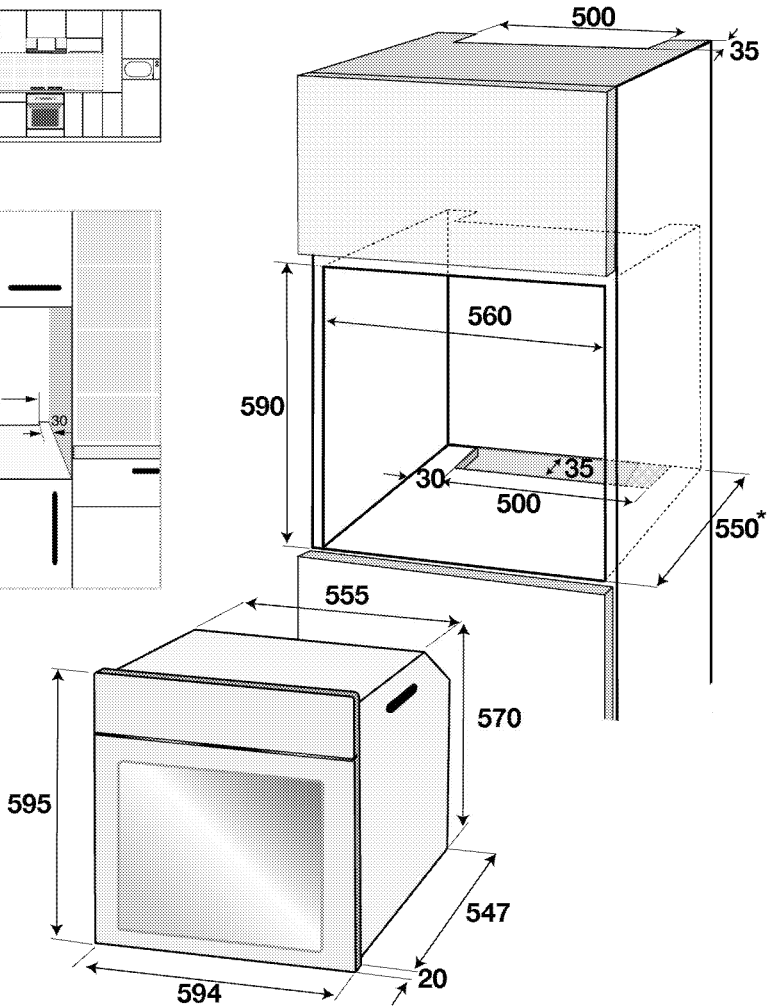
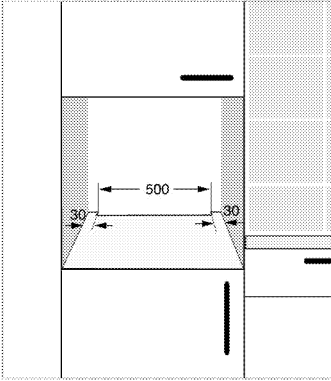
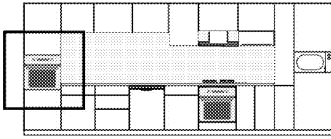

* min.

Installation and connection

- The product must be installed in accordance with all local gas and electrical regulations.

Electrical connection

Connect the product to a grounded outlet/line protected by a miniature circuit breaker of suitable capacity as stated in the "Technical specifications" table. Have the grounding installation

made by a qualified electrician while using the product with or without a transformer. Our company shall not be liable for any damages that will arise due to using the product without a grounding installation in accordance with the local regulations.

 The product must be connected to the mains supply only by an authorised and qualified person. The product's warranty period starts only after correct installation. Manufacturer shall not be held responsible for damages arising from procedures carried out by unauthorised persons.

 The power cable must not be clamped, bent or trapped or come into contact with hot parts of the product. A damaged power cable must be replaced by a qualified electrician. Otherwise, there is risk of electric shock, short circuit or fire!

- Connection must comply with national regulations.
- The mains supply data must correspond to the data specified on the type label of the product. Open the front door to see the type label.
- Power cable of your product must comply with the values in "Technical specifications" table.

 Before starting any work on the electrical installation, disconnect the product from the mains supply. There is the risk of electric shock!

 While performing the wiring, you must apply with the national/local electrical regulations and must use the appropriate socket outlet/line and plug for oven. In case of the product's power limits are out of current carrying capability of plug and socket outlet/line, the product must be connected through fixed electrical installation directly without using plug and socket outlet/line.

Connecting the power cable

 While performing the wiring, you must apply with the national/local electrical regulations and must use the appropriate socket outlet/line and plug for oven. In case of the product's power limits are out of current carrying capability of plug and socket outlet/line, the product must be connected through fixed electrical installation directly without using plug and socket outlet/line.

1. If it is not possible to disconnect all poles in the supply power, a disconnection unit with at least 3 mm contact clearance (fuses, line safety switches, contactors) must be connected and all the poles of this disconnection unit must be adjacent to (not above) the product in accordance with IEE directives. Failure to obey this instruction may cause operational problems and invalidate the product warranty.

Additional protection by a residual current circuit breaker is recommended.

If a cable is supplied with the product:

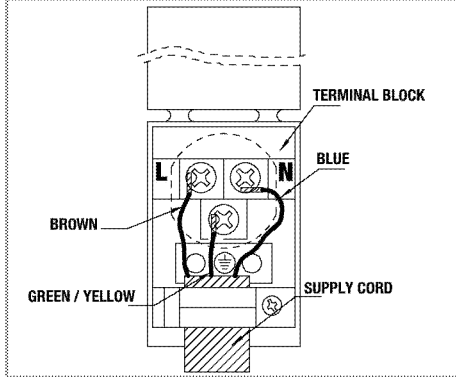

2. For single-phase connection,

connect the wires as identified below:

- Brown/Black cable = L (Phase)
 - Blue/Grey cable = N (Neutral)
 - Green/yellow cable = (E) \oplus (Ground)
- » or
- Grey/Black cable = L (Phase)
 - Blue/Brown cable = N (Neutral)
 - Green/yellow cable = (E) \oplus (Ground)

Installing the product

1. Slide the oven into the cabinet, align and secure it while making sure that the power cable is not broken and/or trapped.

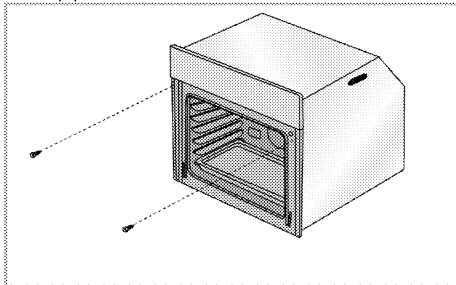

Secure the oven with 2 screws as illustrated.

After the installation, make sure that the screws are sufficiently tightened and the oven does not move. Oven may tip over during use if it is not installed as per the instructions and if the screws are not sufficiently tightened.

For products with cooling fan (This may not exist on your product.)

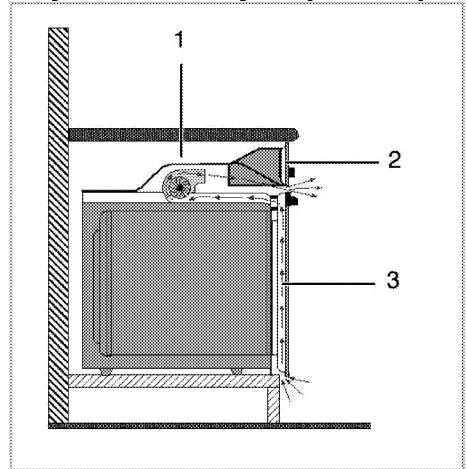

- 1 Cooling fan
- 2 Control panel
- 3 Door

The built-in cooling fan cools both the built-in cabinet and the front of the product.

i Cooling fan continues to operate for about 20-30 minutes after the oven is switched off.



If you have cooked by programming the timer of the oven, cooling fan will also be switched off at the end of the cooking time together with all functions.

Final check

1. Operate the product.
2. Check the functions.

Future Transportation

- Keep the product's original carton and transport the product in it. Follow the instructions on the carton. If you do not have the original carton, pack the product in bubble wrap or thick cardboard and tape it securely.

- To prevent the wire grill and tray inside the oven from damaging the oven door, place a strip of cardboard onto the inside of the oven door that lines up with the position of the trays. Tape the oven door to the side walls.
 - Do not use the door or handle to lift or move the product.
-  Do not place any objects onto the product and move it in upright position.
 -  Check the general appearance of your product for any damages that might have occurred during transportation.

4 Preparation

Tips for saving energy

The following information will help you to use your appliance in an ecological way, and to save energy:

- Use dark coloured or enamel coated cookware in the oven since the heat transmission will be better.
- While cooking your dishes, perform a preheating operation if it is advised in the user manual or cooking instructions.
- Do not open the door of the oven frequently during cooking.
- Try to cook more than one dish in the oven at the same time whenever possible. You can cook by placing two cooking vessels onto the wire shelf.
- Cook more than one dish one after another. The oven will already be hot.
- You can save energy by switching off your oven a few minutes before the end of the cooking time. Do not open the oven door.
- Defrost frozen dishes before cooking them.

Initial use

Time setting

- i** While making any adjustment, related symbols will flash on the display.

Press **+**/**-** keys to set the time of the day after the oven is energized for the first time.

- i** For touch control models, touch **≡** first and then use **+** / **-** to set the time of the day.

Confirm the setting by touching **⏸** symbol and wait for 4 seconds without touching any keys to confirm.

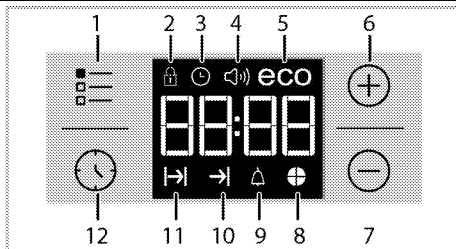

- 1 Adjustment key
- 2 Key lock symbol
- 3 Clock symbol
- 4 Alarm volume symbol (This may not exist on your product.)
- 5 Eco mode symbol
- 6 Plus key
- 7 Minus key
- 8 Time slice symbol
- 9 Alarm symbol
- 10 End of Cooking Time symbol
- 11 Cooking Time symbol
- 12 Program key

- i** If the initial time is not set, clock will run starting from 12:00 and **⏸** symbol will be displayed. The symbol will disappear once the time is set.

- i** Current time settings are canceled in case of power failure. It needs to be readjusted.

First cleaning of the appliance



The surface might get damaged by some detergents or cleaning materials.

Do not use aggressive detergents, cleaning powders/creams or any sharp objects during cleaning.

Do not use harsh abrasive cleaners or sharp metal scrapers to clean the oven door glass since they can scratch the surface, which may result in shattering of the glass.

1. Remove all packaging materials.
2. Wipe the surfaces of the appliance with a damp cloth or sponge and dry with a cloth.

5 How to operate the oven

General information on baking, roasting and grilling



Hot surfaces cause burns! Product may be hot when it is in use. Never touch the hot burners, inner sections of the oven, heaters and etc. Keep children away. Always use heat resistant oven gloves when putting in or removing dishes into/from the hot oven.



Be careful when opening the oven door as steam may escape. Exiting steam can scald your hands, face and/or eyes.

Tips for baking

- Use non-sticky coated appropriate metal plates or aluminum vessels or heat-resistant silicone moulds.
- Make best use of the space on the rack.
- Place the baking mould in the middle of the shelf.
- Select the correct rack position before turning the oven or grill on. Do not change the rack position when the oven is hot.
- Keep the oven door closed.

Tips for roasting

- Treating whole chicken, turkey and large piece of meat with dressings such as lemon juice and black pepper before cooking will increase the cooking performance.
- It takes about 15 to 30 minutes longer to roast meat with bones when compared to roasting the same size of meat without bones.

- Each centimeter of meat thickness requires approximately 4 to 5 minutes of cooking time.
- Let meat rest in the oven for about 10 minutes after the cooking time is over. The juice is better distributed all over the roast and does not run out when the meat is cut.
- Fish should be placed on the middle or lower rack in a heat-resistant plate.

Tips for grilling

When meat, fish and poultry are grilled, they quickly get brown, have a nice crust and do not get dry. Flat pieces, meat skewers and sausages are particularly suited for grilling as are vegetables with high water content such as tomatoes and onions.

- Distribute the pieces to be grilled on the wire shelf or in the baking tray with wire shelf in such a way that the space covered does not exceed the size of the heater.
- Slide the wire shelf or baking tray with grill into the desired level in the oven. If you are grilling on the wire shelf, slide the baking tray to the lower rack to collect fats. The baking tray to be slid must be of a size that covers the whole grilling area. This tray might not be provided with the product. Add some water in the baking tray for easy cleaning.



Foods that are not suitable for grilling carry the risk of fire. Only grill food which is suitable for intensive grilling heat. Do not place the food too far in the back of the grill. This is the hottest area and fatty food may catch fire.

How to operate the electric oven

Your oven is equipped with pop-out knobs that protrude when you press them.

1. Press inwards to protrude the knob and then turn it to make the desired setting.

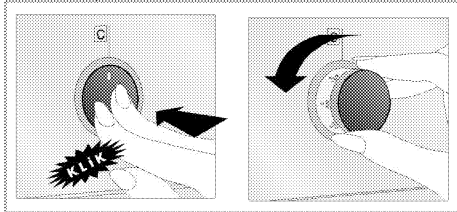

2. When the cooking process is finished, press the knob inwards.

Select temperature and operating mode

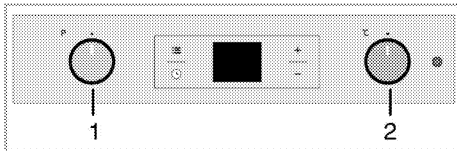

- 1 Function knob
- 2 Thermostat knob

1. Set the Function knob to the desired operating mode.
2. Set the Temperature knob to the desired temperature.

» Oven heats up to the adjusted temperature and maintains it. During heating, temperature lamp stays on.

Switching off the electric oven

Turn the function knob and temperature knob to off (upper) position.

Rack positions (For models with wire shelf)

It is important to place the wire shelf onto the side rack correctly. Wire shelf must be inserted between the side racks as illustrated in the figure.

Do not let the wire shelf stand against the rear wall of the oven. Slide your wire

shelf to the front section of the rack and settle it with the help of the door in order to obtain a good grill performance. (Varies depending on the product model.)

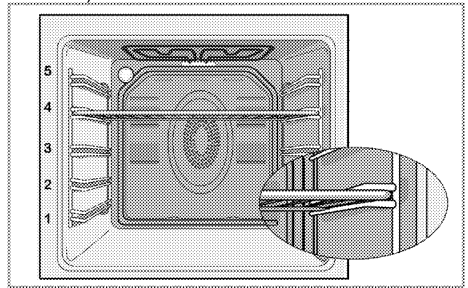

Operating modes

The order of operating modes shown here may be different from the arrangement on your product.

Top and bottom heating



Top and bottom heating are in operation. Food is heated simultaneously from the top and bottom. For example, it is suitable for cakes, pastries, or cakes and casseroles in baking moulds. Cook with one tray only.

Bottom heating



Only bottom heating is in operation. It is suitable for pizza and for subsequent browning of food from the bottom.



This function must be used for easy steam cleaning as well.

Fan supported bottom/top heating



Top heating, bottom heating plus fan (in the rear wall) are in operation. Hot air is evenly distributed throughout the oven rapidly by means of the fan. Cook with one tray only.

Operating with fan



The oven is not heated. Only the fan (in the rear wall) is in operation. Suitable for thawing frozen granular food slowly at room temperature and cooling down the cooked food.

Fan Heating



Warm air heated by the rear heater is evenly distributed throughout the oven rapidly by means of the fan.



It is suitable for cooking your meals in different rack levels and preheating is not required in most cases. Suitable for cooking with multi trays.

This function must be used for easy steam cleaning as well.

3D⁺ function



Top heating, bottom heating and fan assisted heating (in the rear wall) are in operation. Food is cooked evenly and quickly all around. Cook with one tray only.

Full grill



Large grill at the ceiling of the oven is in operation. It is suitable for grilling large amount of meat.

- Put big or medium-sized portions in correct rack position under the grill heater for grilling.
- Turn the food after half of the grilling time.

Grill+Fan



Grilling effect is not as strong as in Full Grill

- Put small or medium-sized portions in correct shelf position under the grill heater for grilling.
- Turn the food after half of the grilling time.

Using the oven clock

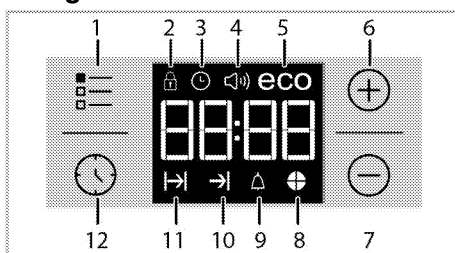

- 1 Adjustment key
- 2 Key lock symbol
- 3 Clock symbol
- 4 Alarm volume symbol (This may not exist on your product.)
- 5 Eco mode symbol
- 6 Plus key
- 7 Minus key
- 8 Time slice symbol
- 9 Alarm symbol

10 End of Cooking Time symbol

11 Cooking Time symbol

12 Program key

i Maximum time that can be set for end of cooking is 5 hours 59 minutes.

Program will be cancelled in case of power failure. You must reprogram the oven.

i While making any setting, related symbols will flash on the display. You must wait for a short time for the settings to take effect.



i If no cooking setting is made, time of the day cannot be set.

i Remaining time will be displayed if cooking time is set when the cooking starts.

Cooking by setting the cooking time;

You can set the oven so that it will stop at the end of the specified time by setting the cooking time on the timer.

1. Select the function for cooking.

2. Touch  until  symbol appears on display for cooking time.

3. Set the cooking time with **+** / **-** keys.

» » After the cooking time is set,  symbol and the time slice will appear on display continuously.

4. Place the dish into the oven and set the temperature with temperature knob. Cooking will start.



» Cooking time starts to count down on display when cooking starts and all parts of time slice symbol is lit. The set

cooking time is divided into 4 equal parts and when the time of each parts ends, the symbol of that parts turns off. So you can understand the ratio of remaining cooking time to total cooking time easily.

Setting the the end of cooking time to a later time;



After setting the cooking time on the timer, you can set the end of cooking time to a later time.

1. Select the function for cooking.



2. Touch  until  symbol appears on display for cooking time.

3. Set the cooking time with **+** / **-** keys.

» » Once the Cooking Time is set,  symbol will appear on display continuously.

4. Touch  until  symbol appears on display for the end of cooking time.

5. Press **+** / **-** keys to set the end of cooking time.

» After the cooking time is set,  symbol plus  symbol and the time slice will appear on display continuously. Once the cooking starts,  symbol disappears.

6. Place the dish into the oven and set the temperature with temperature knob. Cooking will start.

» **Oven timer calculates the startup time by deducting the cooking time from the end of cooking time you have set.** Selected operating mode is activated when the startup time of cooking has come and the oven is heated up to the set temperature. It maintains this temperature until the end of cooking time.

» Cooking time starts to count down on display when cooking starts and all parts of time slice symbol is lit. The set cooking time is divided into 4 equal parts and when the time of each parts ends, the symbol of that parts turns off.

So you can understand the ratio of remaining cooking time to total cooking time easily.

7. After the cooking process is completed, "End" appears on the display and the timer gives an audio warning.

8. Audio warning sounds for 2 minutes. To stop the audio warning, just press any key. Audio warning will be silenced and current time will be displayed.

i If you press any key at the end of the audio warning, the oven will restart operating. Turn the temperature knob and function knob to "0" (off) position to switch off the oven in order to prevent re-operation of the oven at the end of warning.

Activating the keylock

You can prevent digital timer from being intervened with by activating the key lock function.

1. Touch  until  symbol appears on display.

» "OFF" will appear on the display.

2. Press **+** to activate the key lock.

» Once the key lock is activated, "On" appears on the display and the  symbol remains lit.

i Digital timer keys are not functional when the key lock is activated. Key lock will not be cancelled in case of power failure.

To deactivate the keylock

1. Touch  until  symbol appears on display.

» "On" will appear on the display.



2. Disable the key lock by pressing the **-** key.

» "OFF" will be displayed once the keylock is deactivated.

Setting the alarm clock

You can use the timer of the product for any warning or reminder apart from the cooking program.

The alarm clock has no influence on the functions of the oven. It is only used as a warning. For example, this is useful when you want to turn food in the oven at a certain point of time. Timer will give an audio warning at the end of the set time.

1. Touch  until  symbol appears on display.

i Maximum alarm time can be 23 hours and 59 minutes.

2. Set the alarm duration by using **+** / **-** keys.

i Function keys for alarm tone, time of day, display brightness and temperature keys should be at 0 (OFF) position.

»  symbol will remain lit and the alarm time will appear on the display once the alarm time is set.

3. At the end of the alarm time,  symbol starts flashing and the audio warning is heard.



Turning off the alarm

1. Audio warning sounds for 2 minutes.

To stop the audio warning, just press any key.

» Audio warning will be silenced and current time will be displayed.



Cancelling the alarm;

1. Touch  until  symbol appears on display in order to cancel the alarm.

2. Press and hold **-** key until "00:00" is displayed.



i Alarm time will be displayed. If the alarm time and cooking time are set concurrently, shortest time will be displayed.

Changing alarm tone

- 1.Touch  until  symbol appears on display.
 - 2.Adjust the desired alarm tone with **+** / **-** keys.
 - 3.The tone you have set will be activated in a short time.
- » Selected alarm tone will appear as "b-01", "b-02" or "b-03" on the display.

Changing the time of the day

To change the time of the day you have previously set:

- 1.Touch  until  symbol appears on display.
- 2.Set the time of the day with **+** / **-** keys.
- 3.The time you have set will be activated in a short time.

Economy mode

You can save energy with economy mode while cooking by setting cooking time in the oven.

This mode completes the cooking with the inner temperature of the oven by switching off the heaters before the end of cooking time.

Setting the economy mode

- 1.Touch  symbol until **eco** symbol appears on display.
- » "OFF" will appear on the display.
- 2.Enable economy mode by touching **+** key.

» Once the economy mode is activated, "On" appears on the display and the eco symbol remains lit.

Disabling economy mode

- 1.Touch  symbol until **eco** symbol appears on display.
- » "On" will appear on the display.
- 2.Disable economy mode by touching **-** key.
- » "Off" will be displayed once the eco mode is deactivated.

Setting the screen brightness

(This feature is optional. It may not exist on your product.)

- 1.Touch  until d-01 or d-02 or d-03 appears on display for display brightness.
 - 2.Set the desired brightness with **+** / **-** keys.
- » The time you have set will be activated in a short time.

Cooking times table





























The timings in this chart are meant as a guide. Timings may vary due to temperature of food, thickness, type and your own preference of cooking.





Baking and roasting



1st rack of the oven is the **bottom** rack.

Dish	Cooking level number	Accessory to use	Operating mode	Rack position	Temperature (°C)	Cooking time (approx. in min.)
Cakes in tray	One level	Standard tray*		3	180	25 ... 30
Cakes in mould	One level	Cake mold on wire grill**		2	180	40 ... 50
Small cakes	One level	Standard tray*		3	160	25 ... 35
	One level	Standard tray*		3	150	30 ... 40
	2 levels	1-Pastry tray* 3-Standard tray*		1 - 3	150	35 ... 50
	3 levels	1-Standard tray* 3-Pastry tray* 5-Deep tray*		1 - 3 - 5	150	35 ... 50

Dish	Cooking level number	Accessory to use	Operating mode	Rack position	Temperature (°C)	Cooking time (approx. in min.)
Sponge cake	One level	Round springform pan with a diameter of 26 cm on wire grill**		3	160	25 ... 35
	One level	Round springform pan with a diameter of 26 cm on wire grill**		2	150	30 ... 40
	2 levels	1-Round springform pan with a diameter of 26 cm on wire grill** 4-Round springform pan with a diameter of 26 cm on pastry tray**		1 - 4	150	35 ... 45
Cookies	One level	Pastry tray*		3	180	25 ... 30
	2 levels	1-Pastry tray* 3-Standard tray*		1 - 3	180	30 ... 40
	3 levels	1-Pastry tray* 3-Standard tray* 5-Deep tray*		1 - 3 - 5	180	35 ... 45
Dough pastry	One level	Standard tray*		2	200	30 ... 40
	2 levels	1-Pastry tray* 5-Standard tray*		1 - 5	200	45 ... 55
	3 levels	1-Pastry tray* 3-Standard tray* 5-Deep tray*		1 - 3 - 5	200	55 ... 65
Rich pastry	One level	Standard tray*		2	200	25 ... 35
	2 levels	1-Pastry tray* 3-Standard tray*		1 - 3	200	35 ... 45
	3 levels	1-Pastry tray* 3-Standard tray* 5-Deep tray*		1 - 3 - 5	190	45 ... 55
Leaven	One level	Standard tray*		2	200	35 ... 45
Lasagna	One level	Glass/metal rectangular pan on wire grill**		2 - 3	200	30 ... 40
Pizza	One level	Standard tray*		2	200 ... 220	15 ... 20
Beef steak (whole) / Roast	One level	Standard tray*		3	25 min. 250/max, then 180 ... 190	100 ... 120
Leg of Lamb (casserole)	One level	Standard tray*		3	25 min. 250/max, then 190	70 ... 90
	One level	Standard tray*		3	25 min. 250/max, then 190	60 ... 80
Roasted chicken (1,8-2 kg)	One level	Standard tray*		2	15 min. 250/max, then 180 ... 190	60 ... 80
	One level	Standard tray*		2	15 min. 250/max, then 180 ... 190	60 ... 80

Dish	Cooking level number	Accessory to use	Operating mode	Rack position	Temperature (°C)	Cooking time (approx. in min.)
Turkey (5.5 kg)	One level	Standard tray*		1	25 min. 250/max, then 180 ... 190	150 ... 210
	One level	Standard tray*		1	25 min. 250/max, then 180 ... 190	150 ... 210
Fish	One level	Standard tray*		3	200	20 ... 30
	One level	Standard tray*		3	200	20 ... 30

It is suggested to perform preheating for all foods.













* These accessories may not be supplied with the product.



** These accessories are not supplied with the product. They are commercially available accessories.

Cooking table for test meals

Meals in this cooking table are prepared according to EN 60350-1 to make it

easier for control institutes to test the product

Dish	Cooking level number	Accessory to use	Operating mode	Rack position	Temperature (°C)	Cooking time (approx. in min.)
Shortbread	One level	Standard tray*		3	140	20 ... 30
	One level	Standard tray*		3	140	20 ... 30
	2 levels	1-Standard tray* 3-Pastry tray*		1 - 3	140	20 ... 30
	3 levels	1-Standard tray* 3-Pastry tray* 5-Deep tray*		1 - 3 - 5	140	25 ... 35
Small cakes	One level	Standard tray*		3	160	25 ... 35
	One level	Standard tray*		3	150	30 ... 40
	2 levels	1-Pastry tray* 3-Standard tray*		1 - 3	150	35 ... 50
	3 levels	1-Standard tray* 3-Pastry tray* 5-Deep tray*		1 - 3 - 5	150	35 ... 50
Sponge cake	One level	Round springform pan with a diameter of 26 cm on wire grill**		3	160	25 ... 35
	One level	Round springform pan with a diameter of 26 cm on wire grill**		2	150	30 ... 40
	2 levels	1-Round springform pan with a diameter of 26 cm on wire grill** 4-Round springform pan with a diameter of 26 cm on pastry tray**		1 - 4	150	35 ... 45
Apple pie	One level	Round black metal dish with a diameter of 20 cm on wire grill**		2	180	50 ... 60

Dish	Cooking level number	Accessory to use	Operating mode	Rack position	Temperature (°C)	Cooking time (approx. in min.)
	One level	Round black metal dish with a diameter of 20 cm on wire grill**		2	170	50 ... 60
	2 levels	1-Round black metal dish with a diameter of 20 cm on wire grill** 4-Round black metal dish with a diameter of 20 cm on pastry tray**		1 - 4	170	50 ... 60

It is suggested to perform preheating for all foods.
* These accessories may not be supplied with the product.
** These accessories are not supplied with the product. They are commercially available accessories.

Tips for baking cake

- If the cake is too dry, increase the temperature by 10°C and decrease the cooking time.
- If the cake is wet, use less liquid or lower the temperature by 10°C.
- If the cake is too dark on top, place it on a lower rack, lower the temperature and increase the cooking time.
- If cooked well on the inside but sticky on the outside use less liquid, lower the temperature and increase the cooking time.

Tips for baking pastry

- If the pastry is too dry, increase the temperature by 10°C and decrease the cooking time. Dampen the layers of dough with a sauce composed of milk, oil, egg and yoghurt.
- If the pastry takes too long to bake, pay care that the thickness of the pastry you have prepared does not exceed the depth of the tray.
- If the upper side of the pastry gets browned, but the lower part is not cooked, make sure that the amount of sauce you have used for the pastry is not too much at the bottom of the pastry. Try to scatter the sauce equally

between the dough layers and on the top of pastry for an even browning.



Cook the pastry in accordance with the mode and temperature given in the cooking table. If the bottom part is still not browned enough, place it on one lower rack next time.

Tips for cooking vegetables

- If the vegetable dish runs out of juice and gets too dry, cook it in a pan with a lid instead of a tray. Closed vessels will preserve the juice of the dish.
- If a vegetable dish does not get cooked, boil the vegetables beforehand or prepare them like canned food and put in the oven.

How to operate the grill



Close oven door during grilling.
Hot surfaces may cause burns!

Switching on the grill

1. Turn the Function knob to the desired grill symbol.
 2. Then, select the desired grilling temperature.
 3. If required, perform a preheating of about 5 minutes.
- » Temperature light turns on.

Cooking times table for grilling

Grilling with electric grill

Food	Accessory to use	Rack position	Recommended temperature (°C)**	Cooking time (approx. in min.)
Fish	Wire grill	4...5	250	20...25 min. #
Sliced chicken	Wire grill	4...5	250	25...35 min.
Lamb chops	Wire grill	4...5	250	20...25 min.
Roast beef	Wire grill	4...5	250	25...30 min. #
Veal chops	Wire grill	4...5	250	25...30 min. #
Toast bread*	Wire grill	4	250	1...3 min.

depending on thickness

*Preheat for 5 minutes

**If the grill temperature of your product cannot be adjusted, the grill will work at the recommended temperature.

Meals in this cooking table are prepared according to EN 60350-1 to make it easier for control institutes to test the product.

Food	Accessory to use	Rack position	Temperature (°C)	Cooking time (approx. in min.)
Toast bread	Wire grill	4	250	1...3 min.
Meatballs (beef) - 12 pieces	Wire grill	4	250	25...35 min.

Turn the food after 2/3 of the total grilling time.

It is suggested to perform 5 minutes preheating for all foods broiling.

Switching off the grill

1. Turn the Function knob to Off (top) position.



Foods that are not suitable for grilling carry the risk of fire.
Only grill food which is suitable for intensive grilling heat.
Do not place the food too far in the back of the grill. This is the hottest area and fatty food may catch fire.

6 Maintenance and care

General information

Service life of the product will extend and the possibility of problems will decrease if the product is cleaned at regular intervals.



Disconnect the product from mains supply before starting maintenance and cleaning works. There is the risk of electric shock!



Allow the product to cool down before you clean it. Hot surfaces may cause burns!

- Clean the product thoroughly after each use. In this way it will be possible to remove cooking residues more easily, thus avoiding these from burning the next time the appliance is used.
- No special cleaning agents are required for cleaning the product. Use warm water with washing liquid, a soft cloth or sponge to clean the product and wipe it with a dry cloth.
- Always ensure any excess liquid is thoroughly wiped off after cleaning and any spillage is immediately wiped dry.
- Do not use cleaning agents that contain acid or chloride to clean the stainless or inox surfaces and the handle. Use a soft cloth with a liquid detergent (not abrasive) to wipe those parts clean, paying attention to sweep in one direction.



The surface might get damaged by some detergents or cleaning materials.

Do not use aggressive detergents, cleaning powders/creams or any sharp objects during cleaning. Do not use harsh abrasive cleaners or sharp metal scrapers to clean the oven door glass since they can scratch the surface, which may result in shattering of the glass.



Do not use steam cleaners to clean the appliance as this may cause an electric shock.

Cleaning the control panel

Clean the control panel and knobs with a damp cloth and wipe them dry.



If your product is equipped with buttons/knobs do not remove the control buttons/knobs to clean the control panel.

Control panel may get damaged!

Cleaning the oven

To clean the side wall (Varies depending on the product model.) (This feature is optional. It may not exist on your product.)

1. Remove the front section of the side rack by pulling it in the opposite direction of the side wall.
2. Remove the side rack completely by pulling it towards you.

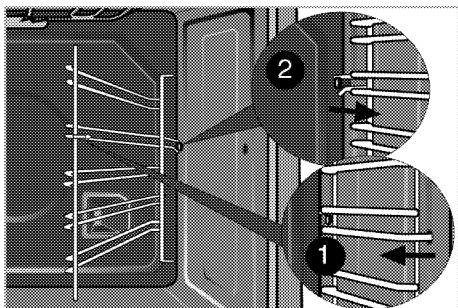

Catalytic walls

(This feature is optional. It may not exist on your product.)

The inner side walls (A) and/or the rear wall (B) of your product may be coated with catalytic enamel. Catalytic walls have a light matte colour and a porous surface. Catalytic walls of the oven should not be cleaned. Thanks to their perforated structure, catalytic surfaces absorb grease and once the surface is filled with grease, they start to shine. In this case, it is recommended to replace the parts.

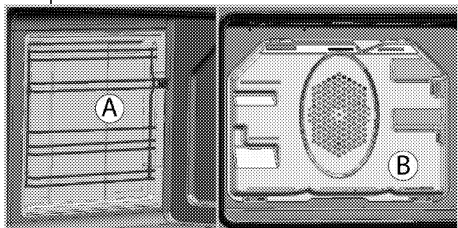

Easy Steam Cleaning

It ensures easy cleaning because the dirt (having waited not for too long) is softened with the steam that forms inside the oven and the water drops condensing on the inner surfaces of the oven.

1. Remove all accessories inside the oven.
2. Pour 500 ml of water into the oven tray and place the tray at the 2nd rack of the oven.

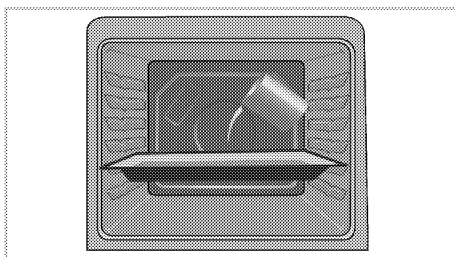

3. Set the oven to easy steam cleaning mode and run at 100°C for 25 minutes.
4. Open the door and wipe the inner surfaces of the oven with a damp sponge or cloth.
5. Use warm water with washing liquid, a soft cloth or sponge to clean the persistent dirt and wipe it with a dry cloth.

i During the easy steam cleaning mode, water that is placed in the tray to soften lightly formed residues/dirt within the oven cavity will evaporate and condense in the oven cavity and inner glass of the oven door, therefore water may drip when the oven door is opened. Wipe away the condensation as soon as the oven door is opened.

Clean oven door

To clean the oven door, use warm water with washing liquid, a soft cloth or sponge to clean the product and wipe it with a dry cloth.

i Don't use any harsh abrasive cleaners or sharp metal scrapers for cleaning the oven door. They could scratch the surface and destroy the glass.

Removing the oven door

1. Open the front door (1).
2. Open the clips at the hinge housing (2) on the right and left hand sides of the

front door by pressing them down as illustrated in the figure.

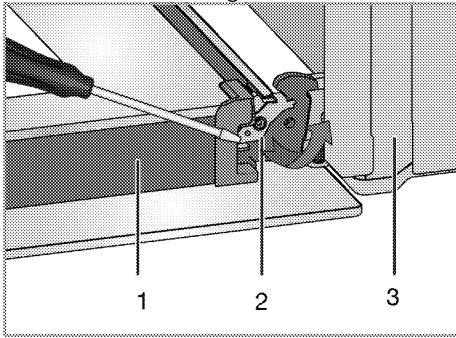

- 1 Door
- 2 Hinge lock(closed position)
- 3 Oven
- 4 Hinge lock(open position)

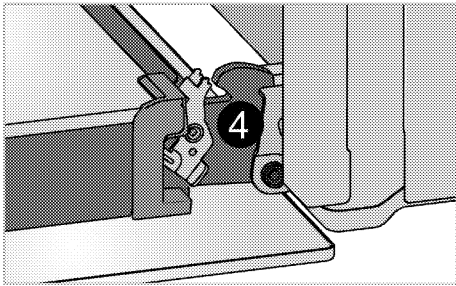

3. Move the front door to half-way.

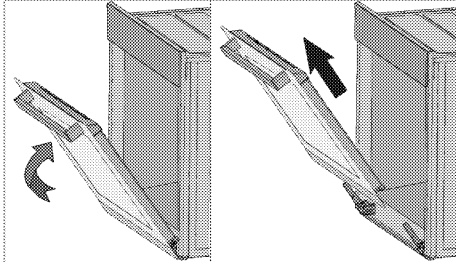

4. Remove the front door by pulling it upwards to release it from the right and left hinges.

i Steps carried out during removing process should be performed in reverse order to install the door. Do not forget to close the clips at the hinge housing when reinstalling the door.

Removing the door inner glass

(This feature is optional. It may not exist on your product.)

The inner glass panel of the oven door can be removed for cleaning.

1. Open the oven door.

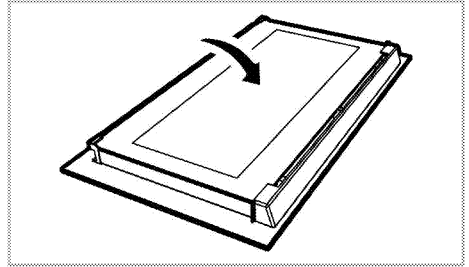

2. Pull towards yourself and remove the plastic part installed to upper section of the front door.

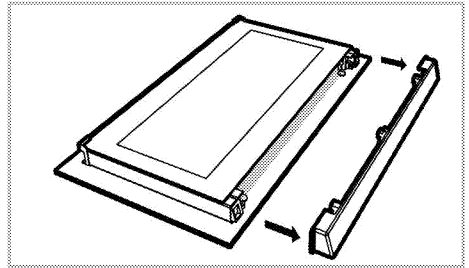

3. As illustrated in figure, raise the innermost glass panel (1) slightly in direction **A** and pull it out in direction **B**.

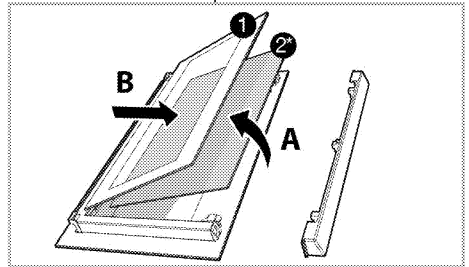

- 1 Innermost glass panel
- 2* Inner glass panel (This may not exist on your product.)
- 4. If your product is equipped with an inner glass panel; repeat the same

procedure to remove the inner glass panel (2).

5. The first step to regroup the door is reinstalling inner glass panel (2). Place the chamfered corner of the glass panel so that it will rest in the chamfered corner of the plastic slot. (If your product is equipped with an inner glass panel). Inner glass panel (2) must be installed into the plastic slot close the innermost glass panel (1).
6. When installing the innermost glass panel (1), make sure that the printed side of the panel faces towards the inner glass panel. It is important to seat lower corner of innermost glass panel (1) into the lower plastic slot.
7. Push the plastic part towards the frame until you hear a "click".

Replacing the oven lamp

! Before replacing the oven lamp, make sure that the product is disconnected from mains and cooled down in order to avoid the risk of an electrical shock.
Hot surfaces may cause burns!

i In this oven, an incandescent lamp with a power of less than 40 W, a height of less than 60 mm, a diameter of less than 30 mm or a halogen lamp with socket type G9, a power of less than 60 W is used. The lamps are suitable for operation at temperatures above 300 °C. Oven lamps can be obtained from Authorised Service Agents or technician with licence.

i Position of lamp might vary from the figure.

i The lamp used in this appliance is not suitable for household room illumination. The intended purpose of this lamp is to assist the user to see foodstuffs.

i The lamps used in this appliance have to withstand extreme physical conditions such as temperatures above 50 °C.

If your oven is equipped with a round lamp:

1. Disconnect the product from mains.
2. Turn the glass cover counter clockwise to remove it.

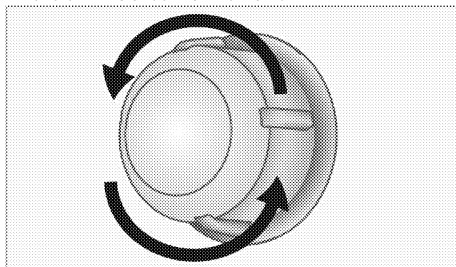

3. If your oven lamp is of type (A) shown in the figure below, remove it by rotating as shown and replace it. If it is of type (B), pull and remove it as shown in the figure and replace it.

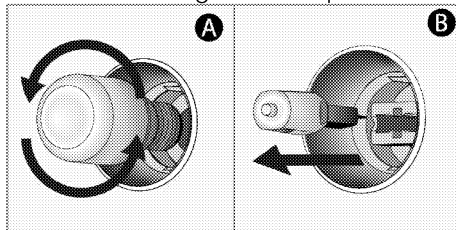

4. Install the glass cover.

7 Troubleshooting

Oven emits steam when it is in use.

- It is normal that steam escapes during operation. >>> *This is not a fault.*

Product emits metal noises while heating and cooling.

- When the metal parts are heated, they may expand and cause noise. >>> *This is not a fault.*

Product does not operate.

- The mains fuse is defective or has tripped. >>> *Check fuses in the fuse box. If necessary, replace or reset them.*
- Product is not plugged into the (grounded) socket. >>> *Check the plug connection.*

Oven light does not work.

- Oven lamp is defective. >>> *Replace oven lamp.*
- Power is cut. >>> *Check if there is power. Check the fuses in the fuse box. If necessary, replace or reset the fuses.*

Oven does not heat.

- Might not be set to a certain cooking function and/or temperature. >>> *Set the oven to a certain cooking function and/or temperature.*
- In models equipped with a timer, the timer is not adjusted. >>> *Adjust the time.* (In products with microwave oven, timer controls only microwave oven.)
- Power is cut. >>> *Check if there is power. Check the fuses in the fuse box. If necessary, replace or reset the fuses.*

(In models with timer) Clock display is blinking or clock symbol is on.

- A previous power outage has occurred. >>> *Adjust the time / Switch of the product and switch it on again.*



Consult the Authorised Service Agent or technician with licence or the dealer where you have purchased the product if you can not remedy the trouble although you have implemented the instructions in this section. Never attempt to repair a defective product yourself.



Ugradna pećnica

Korisnički priručnik

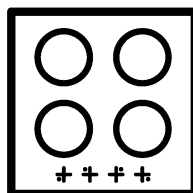
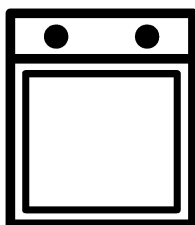

Molimo da prvo pročitate ovo uputstvo!

Poštovani korisniče,
zahvaljujemo na izboru Beko proizvoda. Nadamo se da ćete na najbolji mogući način iskoristiti Vaš proizvod, koji je napravljen sa visokim kvalitetom i vrhunskom tehnologijom. Stoga, molimo da pročitate ovo celo korisničko uputstvo i sva prateća dokumenta pažljivo pre korišćenja proizvoda i čuvajte ih kao podsetnik za buduću upotrebu. Ako ovaj proizvod predate trećem licu, priložite i ovo korisničko uputstvo. Pratite sva upozorenja i informacije iz korisničkog uputstva. Imajte na umu da ovo korisničko uputstvo može da se primeni i na nekoliko drugih modela. Razlike između modela će biti naznačene u priručniku.

Objašnjenje simbola

U ovom korisničkom uputstvu su korišćeni sledeći simboli:



Važne informacije ili korisni saveti u vezi sa korišćenjem.



Upozorenje za situacije koje su opasne po život i imovinu.



Upozorenje za električni udar.



Upozorenje za opasnost od požara.



Upozorenje za vrelе površine.



Arçelik A.Ş.
Karaağaç caddesi No:2-6
34445 Sütlüce/Istanbul/TURKEY
Made in TURKEY

**1 Važna uputstva i upozorenja
za bezbednost i okruženje 4**

Opšta bezbednost.....	4
Bezbednost električnih proizvoda	4
Bezbednost proizvoda	5
Namena	7
Bezbednost dece	8
Odlaganje dotrajalog proizvoda u otpad	8
Odlaganje ambalažnog materijala	8

2 Opšte informacije 9

Pregled	9
Sadržaji pakovanja.....	10
Tehničke specifikacije	11

3 Instalacija 12

Pre instalacije	12
Instalacija i povezivanje	14
Odlaganje dotrajalog proizvoda u otpad	16

4 Pripreme 18

Saveti za uštedu energije.....	18
Prva upotreba.....	18
Podешavanje vremena.....	18
Prvo čišćenje proizvoda	19

5 Kako rukovati rernom 20

Opšte informacije o pečenju, pečenju mesa i pečenju na roštilju	20
Kako koristiti električnu rernu.....	21
Režimi rada	21
Korišćenje sata rerne.....	23
Tabela vremena kuvanja.....	26
Kako rukovati roštiljem	29
Tabela vremena kuvanja za pečenje roštilja.....	30

6 Održavanje i nega 31

Opšte informacije	31
Čišćenje komandne table	31
Čišćenje rerne.....	31
Skidanje vrata rerne	32
Skidanje unutrašnjeg stakla na vratima	33
Zamena sijalice u rerni.....	34

7 Otklanjanje kvarova 35

1 Važna uputstva i upozorenja za bezbednost i okruženje

Ovaj odeljak sadrži sigurnosna uputstva koja će vam pomoći da se zaštitite od opasnosti povreda i oštećenja imovine. Neuspešno praćenje ovih uputstava će poništiti garanciju.

Opšta bezbednost

- Ovaj uređaj mogu koristiti deca starija od 8 godina i osobe sa smanjenim fizičkim, senzornim ili mentalnim sposobnostima ili kojima nedostaju iskustvo i znanje, ako su pod nadzorom ili su dobili uputstva u vezi sa bezbednom upotrebom uređaja i razumeju uključene opasnosti.

Deca se ne smeju igrati sa uređajem. Deca ne smeju čistiti ili održavati uređaj bez nadzora.

- Ovaj uređaj nije namenjen za upotrebu od strane osoba (uključujući decu) sa smanjenim fizičkim, senzornim ili mentalnim sposobnostima ili nedostatkom iskustva i znanja, osim ako su pod nadzorom ili su im data uputstva.

Deca koja su pod nadzorom ne smeju se igrati uređajem.

- Ako se proizvod ustupi drugoj osobi za ličnu upotrebu ili kao polovan proizvod, potrebno je takođe proslediti korisnički priručnik, etikete proizvoda i druge relevantne dokumente i delove.
- Instalaciju i popravke smeju da vrše samo ovlašćeni serviseri. Proizvođač neće snositi odgovornost za štete koje nastanu zbog postupaka koje su obavile neovlašćene osobe, što takođe može poništiti garanciju. Pre instalacije, pažljivo pročitajte uputstva.
- Ne uključujte proizvod ako je u kvaru ili ima vidljivo oštećenje.
- Prekontrolišite da li su funkcijski tasteri na proizvodu isključeni nakon svake upotrebe.

Bezbednost električnih proizvoda

- Ako je proizvod neispravan, ne treba da se koristi dok ga ne popravi ovlašćeni serviser.

Postoji opasnost od električnog udara!

- Proizvod povezujte samo na uzemljenu utičnicu/vod sa naponom i zaštitom navedenim u „Tehničkim specifikacijama“. Uzemljenje instalacije mora da obavi kvalifikovani električar u slučaju da se proizvod koristi sa ili bez transformatora. Naša kompanija neće biti odgovorna ni za kakve probleme koji nastanu zbog korišćenja proizvoda sa neuzemljenom instalacijom u skladu sa lokalnim propisima.
- Nikada ne perite proizvod prskanjem ili sipanjem vode na njega! Postoji opasnost od električnog udara!
- Proizvod mora da bude isključen za vreme instalacije, održavanja, čišćenja i popravke.
- Ako je priključni kabl za napajanje proizvoda oštećen, mora da ga zameni proizvođač, njegov serviser ili odgovarajuće kvalifikovano lice kako bi se izbegle opasnosti.
- Aparat mora da se instalira tako da može potpuno da se isključi sa mreže. Razdvajanje

mora da bude obezbeđeno ili putem mrežnog utikača ili putem prekidača ugrađenog u fiksnu električnu instalaciju u skladu sa građevinskim propisima.

- Zadnja strana rerne se jako zagreva za vreme upotrebe. Pobrinite se da električni priključak ne dodiruje zadnju površinu, jer se može oštetiti.
- Ne prignječujte kabl za napajanje između vrata rerne i okvira i ne vodite ga preko vrućih površina. U suprotnom može doći do topljenja izolacije kabla i do požara zbog kratkog spoja.
- Sve radove na električnoj opremi i sistemima treba da vrše samo ovlašćena kvalifikovana lica.
- U slučaju oštećenja, isključite proizvod i odvojite od električne mreže. Da biste to uradili, isključite osigurač u domaćinstvu.
- Uverite se da je jačina osigurača kompatibilna sa ovim proizvodom.

Bezbednost proizvoda

- **UPOZORENJE:** Uređaj i njegovi pristupačni delovi se zagrevaju tokom upotrebe. Budite pažljivi da biste izbegli

dodirivanje vrućih elemenata. Decu mlađu od 8 godina treba udaljiti osim u slučaju da ih neprekidno nadgledate.

- Nikad ne koristite proizvod u slučaju oslabljenog rasuđivanja ili koordinacije pod uticajem konzumiranja alkohola i/ili lekova.
- Budite pažljivi kada koristite alkoholna pića u vašem posuđu. Alkohol na visokim temperaturama isparava i može da prouzrokuje požar jer se može upaliti ako dođe u kontakt sa vrućim površinama.
- Ne stavljajte nikakav zapaljivi materijal blizu proizvoda, jer njegove stranice mogu da se zagrevaju u toku upotrebe.
- Uređaj se zagreva tokom upotrebe. Budite pažljivi da biste izbegli dodirivanje vrućih elemenata u unutrašnjosti rerne.
- Održavajte čistoću svih ventilacionih otvora.
- Ne zagrevajte zatvorene konzerve i staklene tegle u rerni. Pritisak koji se može stvoriti u plehu/tegli može da izazove njihovo pucanje.
- Plehove za pečenje, posuđe ili aluminijumsku foliju ne

stavljajte direktno na dno rerne. Akumulirana toplota bi mogla da ošteti dno rerne.

- Ne koristite abrazivna sredstva za čišćenje ili tvrde metalne strugače za čišćenje stakla na vratima rerne jer mogu izgrebati površinu, što može dovesti do razbijanja stakla
- Ne koristite paročištače za čišćenje uređaja da ne biste izazvali električni udar.
- **(Razlikuje se u zavisnosti od modela uređaja.)**
Pravilno postavljanje žičane police i pleha na žičane police
Važno je da se žičana polica i/ili pleh pravilno postave na policu. Žičanu policu ili pleh gurnite između 2 šine i proverite stabilnost pre postavljanja jela na njih (vidi sledeću sliku).

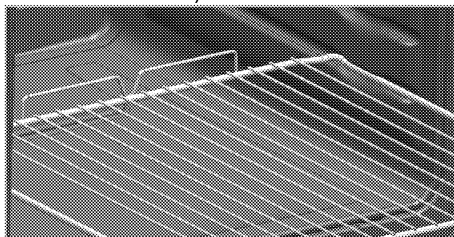

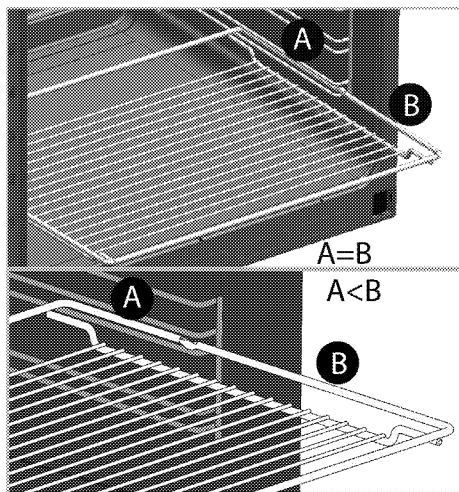

- Ne koristite proizvod ako je staklo na prednjim vratima skinuto ili napuklo.
- Uvek koristite termootporne rukavice za rernu kada posude stavljate ili vadite iz vruće rerne.
- Postavite papir za pečenje u šerpu ili na dodatak za rernu (pleh, gril itd.) zajedno sa hranom, a zatim ubacite sve u prethodno zagrejanu rernu. Uklonite višak delova papira za pečenje koji prelazi dodatak ili šerpu da biste sprečili rizik od dodirivanja grejnih elemenata u rerni. Nikada nemojte da koristite papir za pečenje na temperaturi koja je veća od naznačene temperature za papir za pečenje. Nemojte da

stavljate papir za pečenje direktno na dno rerne.

- **UPOZORENJE:** Pobrinite se da kabl za napajanje aparata bude iskopčan ili automatski prekidač kola isključen pre zamene lampe da biste izbegli mogućnost strujnog udara.
- Uređaj ne sme da se instalira iza dekorativnih vrata da bi se izbeglo pregrevanje.

Za pouzdanost proizvoda od požara:

- Uverite se da je utikač dobro umetnut u utičnicu kako ne bi izazvao varnice.
- Ne koristite oštećen, isečen ili produžni kabl, osim originalnog kabla.
- Pobrinite se da na utičnici na koju je priključen proizvod nema ni vlage ni tečnosti.

Namena

- Ovaj proizvod je namenjen za kućnu upotrebu. Komercijalna upotreba nije dozvoljena.
- **PAŽNJA:** Ovaj aparat služi samo za kuvanje. On ne sme da se koristi za druge svrhe, na primer za grejanje prostorije."
- Ovaj proizvod ne sme se koristiti za zagrevanje tanjira

ispod rešetke roštilja, vešanje peškira, kuhinjskih krpa itd. na ručici, niti u druge svrhe zagrevanja.

- Proizvođač neće biti odgovoran ni za kakve štete koje su nastale kao posledica nenamenske upotrebe ili pogrešnog rukovanja.
- Rerna može da se koristi za odmrzavanje, pečenje i pečenje hrane na roštilju.

Bezbednost dece

- **UPOZORENJE:** Pristupačni delovi mogu da se zagreju za vreme upotrebe. Decu treba udaljiti.
- Materijali za pakovanje su opasni za decu. Ambalažne materijale držite van domašaja dece. Molimo da sve delove ambalaže odložite u otpad u skladu sa ekološkim standardima.
- Električni proizvodi su opasni za decu. Udaljite decu od proizvoda kada je uključen i nemojte im dozvoliti da se igraju sa proizvodom.
- Iznad uređaja ne stavljajte predmete koje bi deca mogla da dohvate.
- Kada su vrata otvorena, ne stavljajte teške predmete na njih i ne dozvolite da deca

sede na njima. To može da dovede do prevrtanja i mogu da se oštete šarke vrata.

Odlaganje dotrajalog

proizvoda u otpad

Usaglašenost sa WEEE direktivom i odlaganje otpada:



Ovaj proizvod je usaglašen sa WEEE direktivom Evropske Unije (2012/19/EU). Ovaj proizvod nosi znak klasifikacije za električni i elektronski otpad (WEEE). Ovaj proizvod je proizveden od visoko kvalitetnih delova i materijala koji se mogu ponovo koristiti i pogodni su za reciklažu. Nemojte odlagati proizvod u otpad sa običnim kućnim otpadom i drugim otpadima na kraju veka trajanja. Odložite ga u centar za sakupljanje i reciklažu električnog i elektronskog otpada. Konsultujte se sa svojim lokalnim vlastima da biste saznali o ovim centrima za sakupljanje otpada.

Usaglašenost sa RoHS direktivom:

Proizvod koji ste kupili u saglasnosti je sa RoHS direktivom Evropske Unije (2011/65/EU). On ne sadrži štetne i zabranjene materijale navedene u direktivi.

Odlaganje ambalažnog materijala

- Ambalažni materijali su opasni po decu. Ambalažni materijal čuvajte na bezbednom mestu, van domašaja dece. Ambalažni materijali za ovaj proizvod su proizvedeni od materijala koji se mogu reciklirati. Odložite ih pravilno i sortirajte u skladu sa uputstvima za recikliranje otpada. Ne odlažite ih sa običnim kućnim otpadom.

2 Opšte informacije

Pregled

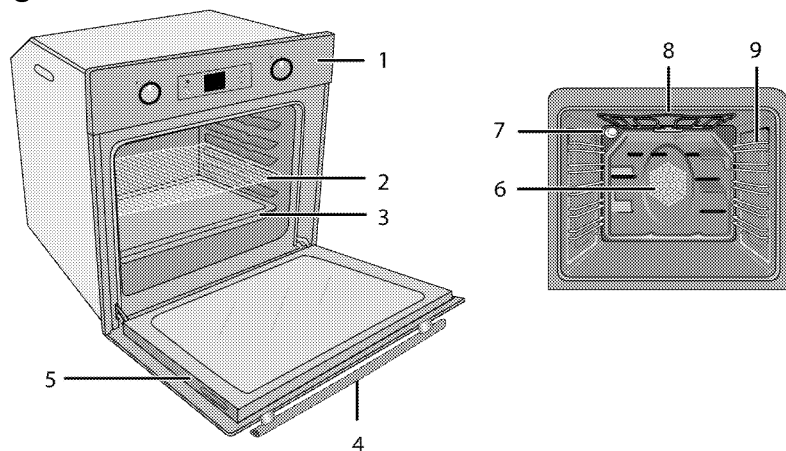

- 1 Kontrolna tabla
- 2 Žičana polica
- 3 Pleh
- 4 Ručka
- 5 Vrata

- 6 Motor ventilatora (iza čelične ploče)
- 7 Lampa
- 8 Gornji grejač
- 9 Položaji police

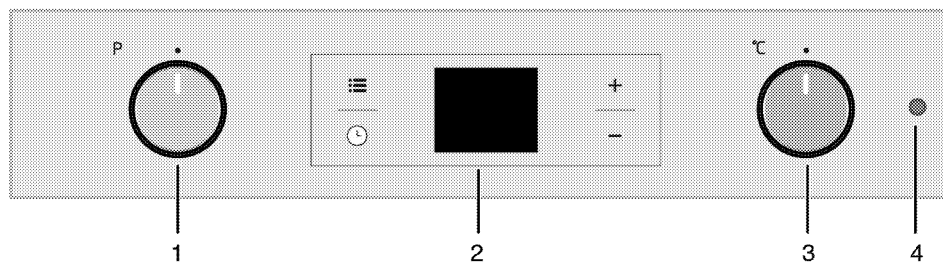

- 1 Obrtno dugme za izbor funkcije
- 2 Digitalni vremenski programator
- 3 Obrtno dugme termostata
- 4 Lampica termostata

Sadržaji pakovanja

i Isporučeni pribor može da se razlikuje u zavisnosti od modela uređaja. Sav pribor, koji je opisan u ovom korisničkom priručniku, možda neće postojati kod vašeg proizvođača.

1. Korisnički priručnik

2. Standardni pleh

Koristi se za peciva, smrznutu hranu ili pečenje velikih komada mesa.

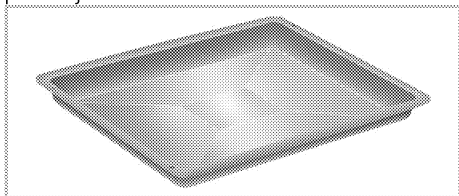

3. Žičani roštilj

Koristi se za pečenje i za stavljanje šerpe sa hranom koja treba da bude pečena, pržena ili kuvana na željenu policu.

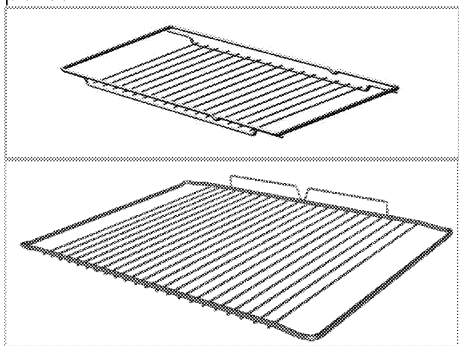

4. Pravilno postavljanje žičane police i pleha na teleskopske police

(Ova funkcija je opcionalna. Možda neće postojati kod vašeg proizvođača.)

Teleskopske police vam omogućavaju da lako postavljate i uklanjate plehove i žičanu policu.

Kada koristite pleh i žičanu policu sa teleskopskim policama uverite se da trnovi na zadnjem delu teleskopske police stoje naspram uglova žičane police i pleha.

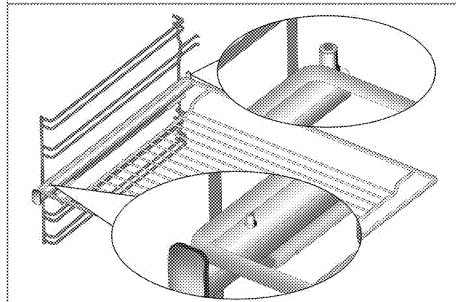
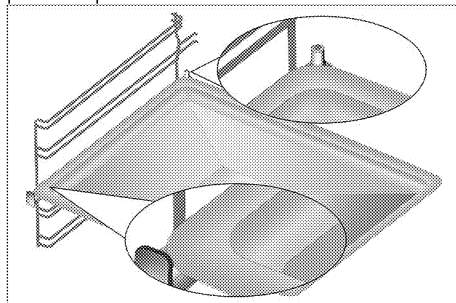

Tehničke specifikacije

Napon/frekvencija	220-240 V~ 50 Hz
Ukupna potrošnja energije	2.5 kW
Tip kabla / poprečni presek	min.H05VV-FG 3 x 1,5 mm ²
Spoljne dimenzije (visina/širina/dubina)	595 mm/594 mm/567 mm
Ugradne dimenzije (visina/širina/dubina)	**590 ili 600 mm/560 mm/min. 550 mm
Glavna rena	Rerna sa više funkcija
Unutrašnja lampa	15/25 W
Potrošnja roštilja	2.2 kW

Osnovi: Informacije na nalepnici energetskeg rejtinga električnih remi navedene su u skladu sa EN 60350-1 / IEC 60350-1 standardom. Ove vrednosti su određene pod standardnim opterećenjem sa gornjim i donjim grejačem ili sa funkcijama koje uključuju ventilator (ako postoje).

Klasa energetske efikasnosti je određena u skladu sa sledećim prioritetom u zavisnosti od toga da li relevantne funkcije postoje kod proizvoda ili ne. 1- Kuvanje sa eko ventilatorom, 2- Turbo sporo kuvanje, 3- Turbo kuvanje, 4- Zagrevanje odozdo/odozgo uz pomoć ventilatora, 5-Zagrevanje odozgo i odozdo.

** Pogledajte . *Instalacija, strana 12.*

i Tehničke specifikacije se mogu izmeniti bez prethodnog obaveštenja da bi se poboljšao kvalitet proizvoda.

i Slike koje su date u ovom uputstvu za upotrebu su samo ilustrativne i možda se neće u potpunosti poklapati sa vašim proizvodom.

i Vrednosti, koje su navedene na oznakama proizvoda ili u drugoj dokumentaciji koju ste dobili uz proizvod, dobijene su pod laboratorijskim uslovima u skladu sa odgovarajućim standardima. U zavisnosti od radnih uslova i uslova okruženja proizvoda, ove vrednosti se mogu razlikovati.

3 Instalacija

Proizvod mora da instalira kvalifikovano lice u skladu sa važećim propisima. U suprotnom, garancija neće važiti. Proizvođač neće biti odgovoran za štete koje nastanu zbog postupaka koje su obavile neovlašćene osobe i može da poništi garanciju.



 Priprema lokacije i električne instalacije za proizvod su odgovornost kupca.

 Ovaj proizvod mora da se instalira u skladu sa svim lokalnim propisima za gasne i/ili električne instalacije.

 Pre instalacije vizuelno proverite da li na proizvodu postoje bilo kakva oštećenja. Ako ustanovite oštećenja, nemojte ga instalirati. Oštećeni proizvodi predstavljaju opasnost po vašu bezbednost.

Pre instalacije

Ovaj aparat je namenjen za ugradnju u kuhinjske ormariće koji se mogu kupiti u prodavnicama. Između aparata i zidova kućišta i nameštaja mora da se ostavi bezbedan ramak. Pogledajte sliku (vrednosti su u mm).

- Površine, sintetički laminati i lepkovi moraju da budu otporni na toplotu (minimalno 100 °C).
 - Kuhinjski ormarići moraju da budu nivelisani i učvršćeni.
 - Ako se ispod rerne nalazi fioka, mora da se instalira polica između rerne i fioke.
 - Aparat moraju da nose najmanje dve osobe.
 - Držite rernu za otvore za držanje na obe strane i pomerite je.
 - Pre postavljanja proizvoda uklonite sav materijal i dokumente koji se nalaze unutra.
 - Kuhinjski nameštaj mora da bude usaglašen sa dimenzijama koje su date na slici u nastavku. U zadnjem odeljku kuhinjskog nameštaja sečenjem mora da se napravi otvor dimenzija datih na slici u nastavku da bi se obezbedila dovoljna ventilacija.
-  Ne instalirajte proizvod pored frižidera ili zamrzivača. Toplota koju emituje proizvod može da prouzrokuje povećanu potrošnju energije rashladnih aparata.
-  Ne koristite vrata i/ili ručicu za nošenje ili pomeranje ovog proizvoda.

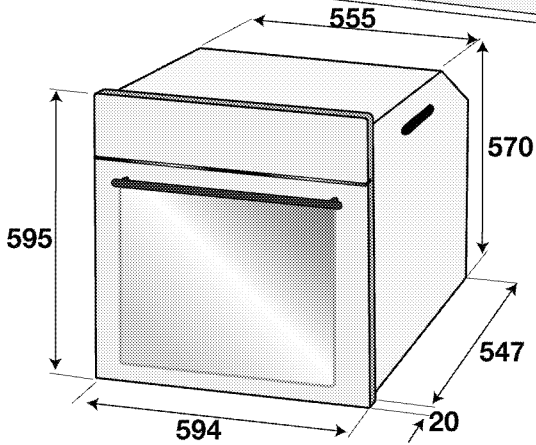
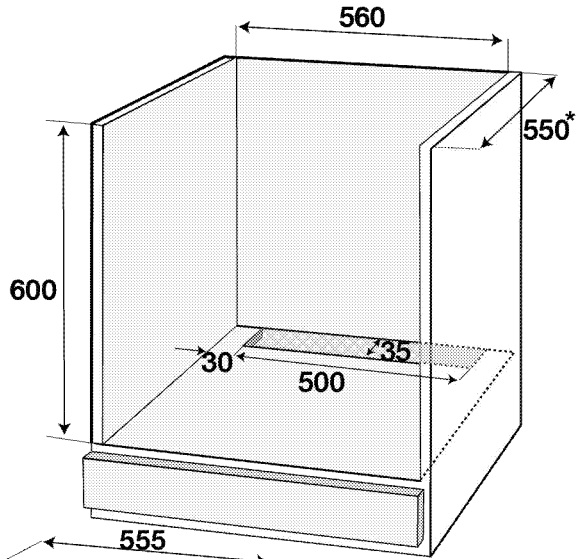
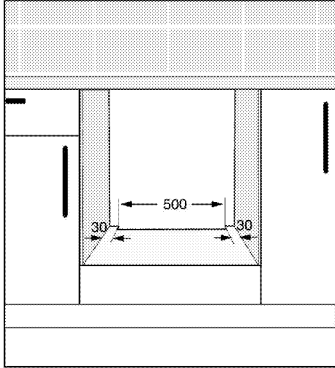
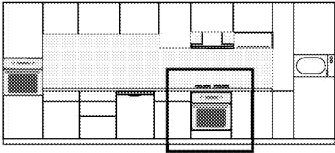

* min.

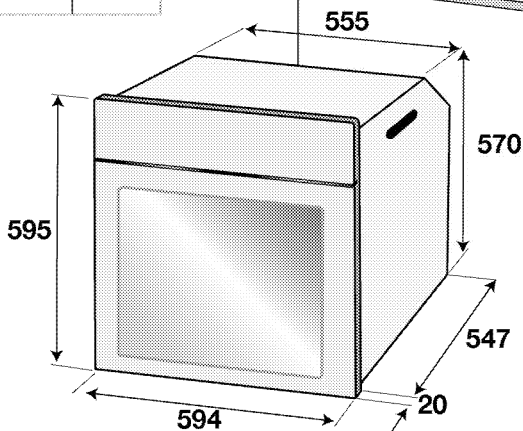
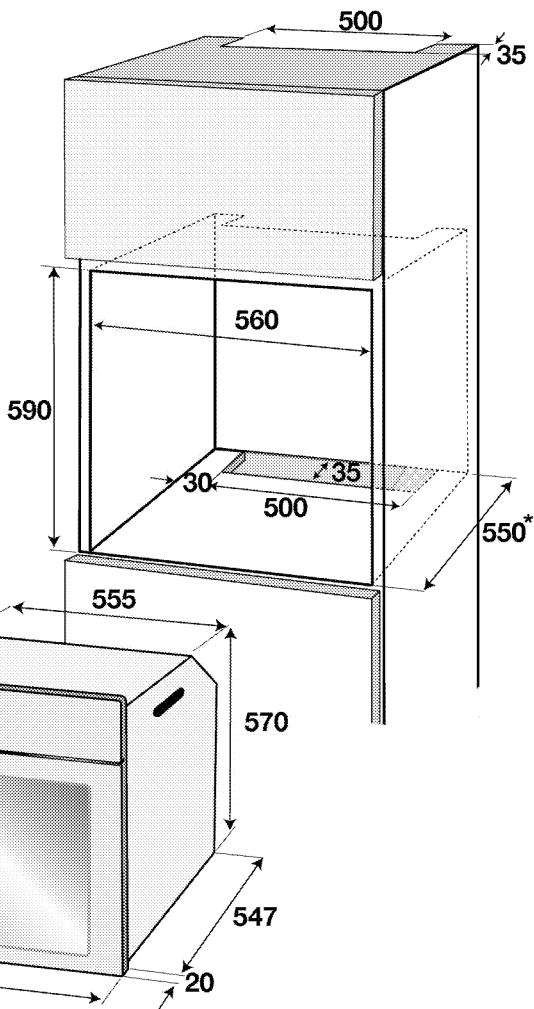
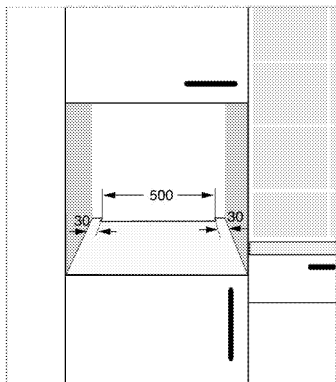
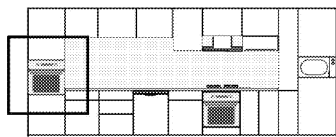

* min.

Instalacija i povezivanje

- Uređaj se može instalirati i povezati samo u skladu sa propisanim pravilima za instalaciju.

Električno povezivanje

Povežite proizvod sa uzemljenom utičnicom koja je zaštićena minijaturnim prekidačem odgovarajućeg kapaciteta kao što je navedeno u tabeli „Tehničke specifikacije“. Angažujte kvalifikovanog

električara da obavi povezivanje sa uzemljenom instalacijom dok koristite proizvod sa ili bez transformatora. Naša kompanija nije odgovorna ni za kakvu štetu koja će prosteći zbog korišćenja proizvoda bez uzemljene instalacije u skladu sa lokalnim propisima.

 Na gasnu mrežu proizvod sme da priključi samo ovlašćeno kvalifikovano lice. Garantni rok za proizvod počinje samo nakon pravilne instalacije. Proizvođač neće biti odgovoran za štete koje nastanu zbog postupaka koje su obavile neovlašćene osobe.

 Električni kabl za napajanje ne sme da se priklešti, savije ili prignječi ili da dođe u dodir sa vrućim delovima proizvoda. Oštećeni kabl za napajanje mora da zameni kvalifikovani električar. U suprotnom, postoji opasnost od električnog udara, kratkog spoja ili požara!

- Povezivanje mora da se izvede u skladu sa nacionalnim propisima.
- Podaci o mrežnom napajanju moraju da odgovaraju podacima koji su navedeni na tipskoj pločici proizvoda. Otvorite prednja vrata da biste videli tipsku pločicu.
- Kabl za napajanje vašeg proizvoda mora da bude u skladu sa vrednostima u tabeli „Tehničke specifikacije“.

 Pre radova na električnoj instalaciji isključite proizvod iz struje. Postoji opasnost od električnog udara!

 Tokom povezivanja žica morate da poštujuete nacionalne/lokalne propise o struji i morate da koristite odgovarajuću utičnicu i utikač za rernu. U slučaju da ograničenja napajanja uređaja premašuju nominalne vrednosti struje za utikač i utičnicu, proizvod mora da se poveže preko fiksne električne instalacije direktno bez korišćenja utikača i utičnice.

Povezivanje kabla za napajanje

 Tokom povezivanja žica morate da poštujuete nacionalne/lokalne propise o struji i morate da koristite odgovarajuću utičnicu i utikač za rernu. U slučaju da ograničenja napajanja uređaja premašuju nominalne vrednosti struje za utikač i utičnicu, proizvod mora da se poveže preko fiksne električne instalacije direktno bez korišćenja utikača i utičnice.



1. Ukoliko nije moguće isključiti napajanje preko svih izvoda (polova), rastavni uređaj sa najmanje 3 mm zazora kontakta (osigurači, fazni sigurnosni prekidači, kontaktori) moraju da se povežu, a svi polovi ovog rastavnog uređaja moraju da budu u blizini proizvoda (ne iznad) u skladu sa IEE smernicama. Nepridržavanje ovog uputstva može da dovede do problema u radu i poništavanja garancije za proizvod.

Preporučuje se dodatna zaštita putem FID sklopke za zaštitu od struje greške.

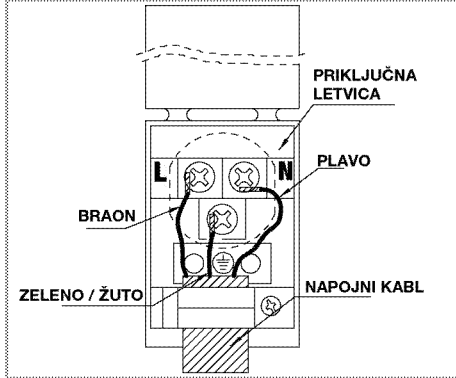
Ako je kabl isporučen sa proizvodom:



2. Za jednofazno povezivanje, žice treba povezati na sledeći način:

- Braon/crni kabl = L (faza)
 - Plavi/ kabl = N (nula)
 - Zeleno/žuti kabl = (E)  (Uzemljenje)
- » ili
- /crni kabl = L (faza)
 - Plavi/Braon kabl = N (nula)
 - Zeleno/žuti kabl = (E)  (Uzemljenje)

Instalacija proizvoda

Instalacija proizvoda

1. Umetnite remu u ormarić, poravnajte je i učvrstite vodeći računa da kabl za napajanje nije prekinut i/ili zaglavljen.

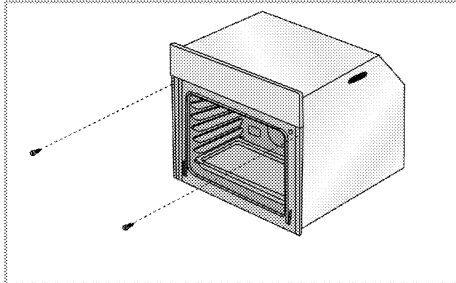

Učvrstite remu pomoću 2 zavrtnja kao što je prikazano na slici.

Nakon postavljanja postarajte se da su zavrtnji dovoljno zategnuti i da se rema ne pomera. Rema može da se prevrne tokom korišćenja ako se ne postavi u skladu sa uputstvima i ako zavrtnji nisu dovoljno zategnuti.

Za uređaje sa rashladnim ventilatorom (Možda neće postojati kod vašeg proizvoda.)

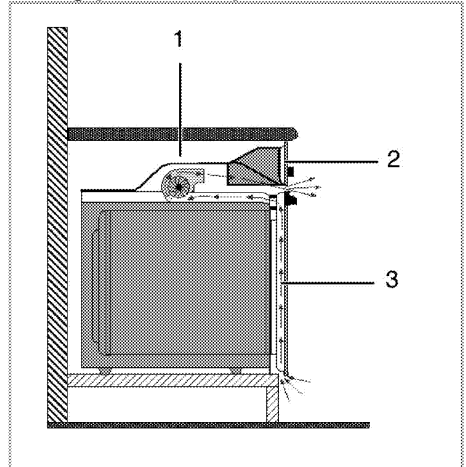

- 1 Cooling fan (Rashladni ventilator)
- 2 Kontrolna tabla
- 3 Vrata

Ugrađeni rashladni ventilator hladi i ugradni modul i prednji deo uređaja.

i Rashladni ventilator nastavlja da radi još 20-30 minuta nakon što je rema isključena.

Ako ste kuvali sa programiranim tajmerom rerne, rashladni ventilator će se takođe isključiti na kraju vremena kuvanja, zajedno sa svim funkcijama.

Finalna provera

1. Rukujte proizvodom.
2. Proverite sve električne funkcije.

Odlaganje dotrajalog proizvoda u otpad

- Sačuvajte originalnu ambalažnu kutiju ovog proizvoda i transportujte proizvod u njoj. Pratite uputstva na kutiji. Ako nemate originalnu ambalažnu kutiju, proizvod upakujte u foliju za pakovanje sa vazдушnim

mehurićima ili deblji karton i dobro zalepите.

- Da biste sprečili da rešetka za roštilj i pleh u remini oštete vrata rene, postavite komad kartona na unutrašnju stranu vrata rene prema položaju plehova. Vrata rene zalepите trakom za bočne stranice.
- Ne koristite vrata ili ručicu za podizanje ili pomeranje ovog proizvoda.

i Ne stavljajte nikakve predmete na proizvod i premeštajte ga u uspravnom položaju.

i Proverite opšti izgled svog proizvoda da biste pronašli eventualna oštećenja koja su mogla nastati za vreme transporta.

4 Pripreme

Saveti za uštedu energije

Sledeće informacije će vam pomoći da vaš uređaj koristite na ekološki način i štedite energiju:

- U rerni koristite emajlirane poklopce ili poklopce tamne boje jer će prenos toplote biti bolji.
- Dok kuvate jela, obavite predzagrevanje ako se to savetuje u korisničkom uputstvu ili receptu.
- U toku pečenja ne otvarajte često vrata rerne.
- Kad god je moguće, kuvajte više jela u rerni istovremeno. Možete da kuvate dva jela u dve šerpe koje se mogu staviti na žičanu rešetku za roštilj.
- Kuvajte više jela jedno za drugim. Jer će rerma već biti zagrejana.
- Možete da uštedite energiju tako što ćete električnu rernu isključiti nekoliko minuta pre kraja vremena kuvanja. Ne otvarajte vrata rerne.
- Odmrznite smrznuta jela pre pečenja.

Prva upotreba

Podešavanje vremena

i Odgovarajući simboli trepću na ekranu za vreme podešavanja.

Pritisnite tastere **+**/**-** da biste podesili vreme nakon što je rerma uključena prvi put.

i Za modele sa upravljanjem na dodir najpre dodirnite **≡**, a zatim koristite **+** / **-** da biste podesili vreme u toku dana.

Potvrdite postavku tako što ćete dodirnuti simbol **⌚** i sačekati 4 sekunde bez dodirivanja tipki da potvrdite.

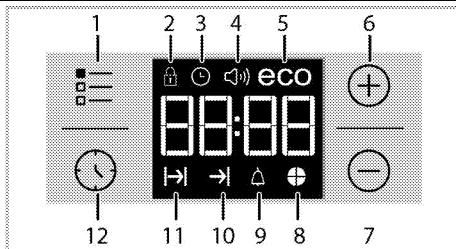

- 1 Taster za podešavanje
- 2 Simbol blokade tastera
- 3 Simbol sata
- 4 Simbol jačine zvuka alarma (Možda neće postojati kod vašeg proizvoda.)
- 5 Simbol Eko režima
- 6 Taster plus
- 7 Taster minus
- 8 Simbol vremenskog indikatora
- 9 Simbol alarma
- 10 Simbol za kraj vremena kuvanja
- 11 Simbol vremena kuvanja
- 12 Taster za program

i Ako početno vreme nije podešeno, sat će se pokrenuti od **12:00** a simbol **⌚** će biti prikazan. Ovaj simbol nestaje kada se tačno vreme podesi.

i Podešavanje tačnog vremena se poništava u slučaju nestanka struje. Ono se mora ponovo podesiti.

Prvo čišćenje proizvoda



Prilikom upotrebe nekih deterdženata ili sredstava za čišćenje mogla bi da se ošteti površina.

Ne koristite agresivne deterdžente, praškove/tečnosti za čišćenje ili oštre predmete tokom čišćenja.

1. Uklonite sve ambalažne materijale.
2. Obrišite površine proizvoda vlažnom krpom ili sunđerom i osušite ga krpom.

5 Kako rukovati rernom

Opšte informacije o pečenju, pečenju mesa i pečenju na roštilju



Vruće površine mogu da prouzrokuju opekotine! Uređaj može da bude vruć za vreme upotrebe. Nikada ne dodirujte vruće gorionike, unutrašnje delove rerne, grejače itd. Udaljite decu.

Uvek koristite termootporne rukavice za rernu kada posude stavljate ili vadite iz vruće rerne.



Vodite računa kada otvarate vrata rerne, jer može da izađe para. Para koja izlazi može da opeče vaše ruke, lice i/ili oči.

Saveti za pečenje

- Koristite odgovarajuće metalne tepsije ili aluminijumske posude ili termootporne silikonske kalupe.
- Prostor na polici iskoristite što je moguće bolje.
- Stavite kalup za pečenje na sredinu police.
- Izaberite pravilan položaj police pre nego što uključite rernu ili roštilj. Ne menjajte položaj police dok je rerna vruća.
- Vrata rerne držite zatvorena.

Saveti za pečenje mesa

- Prelivanje celog pileta, ćurke i velikih komada mesa sa prelivima kao što su sok od limuna i crni biber pre kuvanja će povećati efikasnost kuvanja.
- Pečenje mesa sa kostima traje 15 do 30 minuta duže u poređenju sa pečenjem iste količine mesa bez kostiju.

- Svaki centimetar debljine mesa zahteva približno 4 do 5 minuta kuvanja.
- Pustite da meso ostane u rerni oko 10 minuta po završetku vremena kuvanja (cooking time). Sokovi se bolje raspodeljuju po celom pečenju i ne ističu kada se meso seče.
- Riba se može staviti na srednju ili donju policu u termootpornu posudu.

Saveti za pečenje na roštilju

Ako se meso, riba i piletina peku na roštilju, oni brzo dobijaju braonkastu boju, imaju lepu koricu i ne suše se. Ravni komadi, ražnjići i kobasice su naročito pogodni za pečenje na roštilju, kao i povrće sa visokim sadržajem vode kao što su paradajz i crni luk.

- Rasporedite komade koje treba peći na žičanoj rešetki roštilja ili u plehu za pečenje sa rešetkom za roštilj tako da oni ne prelaze veličinu grejača.
- Namestite žičanu policu za pečenje sa rešetkom za roštilj na odgovarajućem nivou u rerni. Ako pečete na žičanoj polici, namestite pleh za pečenje na donjoj polici radi sakupljanja masnoće. Dimenzija pleha za pečenje koji treba namestiti mora da omogućiti pokrivanje celokupne oblasti pečenja. Ovaj pleh se možda ne isporučuje uz proizvod. U pleh za pečenje dodajte malo vode radi lakšeg čišćenja.



Hrana koja nije podesna za pečenje na roštilju može da prouzrokuje požar. Za pečenje na roštilju koristite samo hranu koja je prikladna za intenzivnu toplotu roštilja.

Ne stavljajte hranu u zadnji deo rešetke za roštilj. To je najtoplija oblast, pa bi masna hrana mogla da se upali.

Kako koristiti električnu rernu

Izbor temperature i način rada

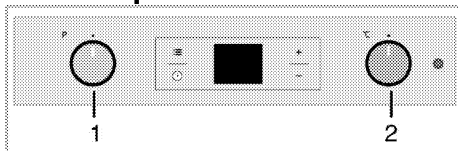

1 Obrtno dugme za izbor funkcije

2 Obrtno dugme termostata

Na vašoj rerni postoje iskačuća dugmad koja iskaču kada ih pritisnete.

1. Pritisnite dugme da bi iskočilo, a zatim ga okrenite da izvršite željena podešavanja.

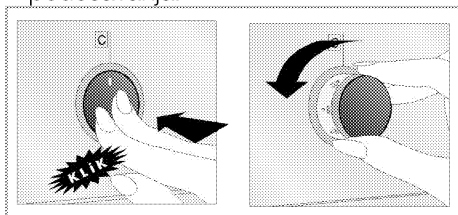

2. Kada se proces kuvanja završi, pritisnite dugme ka unutra.

1. Podesite dugme za izbor funkcije na željeni režim rada.

2. Podesite dugme za temperaturu na željenu temperaturu.

» Rerna se zagreva na podešenu temperaturu i održava je. Za vreme zagrevanja, kontrolna lamica za temperaturu je uključena.

Isključivanje električne rerne

Okrenite dugme za izbor funkcije i dugme termostata u položaj „isključeno“ (gore).

Važno je da se rešetka za roštilj pravilno postavi na žičanu policu. Rešetka za roštilj mora biti ubačena između žičanih policica kao što je prikazano na slici.

Ne dozvolite da se rešetka za roštilj oslanja na zadnji zid rerne. Namestite rešetku za roštilj na prednji deo police i uglavite je uz pomoć vrata kako bi se postigla veća efikasnost pečenja na roštilju.

(Razlikuje se u zavisnosti od modela uređaja.)

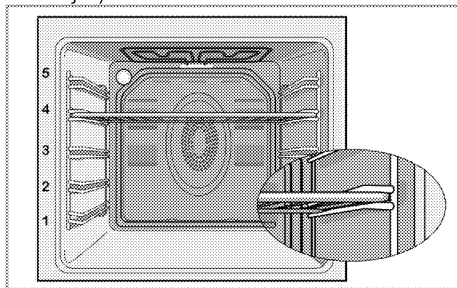

Režimi rada

Redosled radnih režima je prikazan tamo gde bi mogao da odstupa od konfiguracije vašeg proizvoda.

Gornji i donji grejač



Gornji i donji grejač su uključeni. Jelo se istovremeno zagreva i od vrha i od dna. Na primer, pogodno je za torte, peciva, ili kolače i musaku u kalupima za pečenje. Kuvajte samo sa jednim plehom.

Donji grejač



Uključen je samo donji grejač. Pogodan je za picu i da naknadno zapečete jelo odozdo.



Ova funkcija se mora koristiti i za lako čišćenje parom.

Donji/gornji grejač sa ventilatorom



Gornji grejač, donji grejač i ventilator (u zadnjem zidu) su uključeni. Pomoću ventilatora se vruć vazduh ravnomerno i brzo distribuira po celoj remi. Kuvajte samo sa jednim plehom.

Rad sa ventilatorom



Rerna se ne zagreva. Uključen je samo ventilator (u zadnjem zidu). Pogodno za odmrzavanje smrznute hrane na sobnoj temperaturi i hlađenje kuvane hrane.

Zagrevanje ventilatorom



Topao vazduh, koji se zagreva zadnjim grejačem, se pomoću ventilatora ravnomerno i brzo širi kroz renu.



To je pogodno za kuvanje jela na različitim nivoima policia, a u većini slučajeva nije potrebno predzagrevanje. Pogodno za kuvanje sa više plehova. Ova funkcija se mora koristiti i za lako čišćenje parom.

"3D" funkcija



Gornji grejač, donji grejač i zagrevanje ventilatorom (u zadnjem zidu) su uključeni. Jelo se kuva ravnomerno i brzo sa svih strana. Kuvajte samo sa jednim plehom.

Full grill (Veliki roštilj)



Uključen je veliki roštilj ispod gornjeg dela rerne. To je pogodno za pečenje velikog komada mesa na roštilju.

- Da biste ispekli roštilj, stavite velike ili srednje porcije na odgovarajuću policu ispod grejača za roštilj.
- Okrenite hranu nakon polovine vremena pečenja roštilja.

Grill+Fan (Roštilj+Ventilator)



Efekat roštilja nije tako jak kao za Full Grill (Veliki roštilj)

- Da biste ispekli roštilj, stavite male ili srednje porcije na odgovarajuću policu ispod grejača za roštilj.
- Okrenite hranu nakon polovine vremena pečenja roštilja.

Korišćenje sata rerne

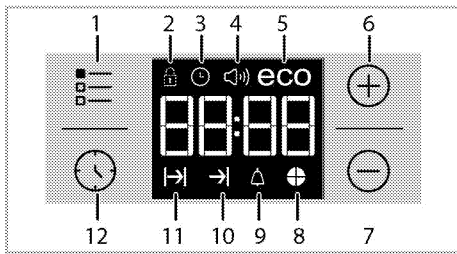

- 1 Taster za podešavanje
- 2 Simbol blokade tastera
- 3 Simbol sata
- 4 Simbol jačine zvuka alarma (Možda neće postojati kod vašeg proizvoda.)
- 5 Simbol Eko režima
- 6 Taster plus
- 7 Taster minus
- 8 Simbol vremenskog indikatora
- 9 Simbol alarma
- 10 Simbol za kraj vremena kuvanja
- 11 Simbol vremena kuvanja
- 12 Taster za program

i Maksimalno vreme koje se može podesiti za kraj kuvanja je 5 sati 59 minuta. Program se poništava u slučaju nestanka struje. Morate reprogramirati rernu.

i Odgovarajući simboli trepću na ekranu za vreme podešavanja. Morate malo da sačekate da postavke postanu važeće.

i Ako nijedno podešavanje kuvanja nije izvršeno, tačno vreme se ne može podesiti.

i Preostalo vreme kuvanja će biti prikazano ako je vreme kuvanja podešeno kada kuvanje počne.

Kuvanje pomoću podešavanja vremena kuvanja;



Možete da podesite rernu tako da se isključi na kraju zadatog vremena podešavanjem vremena kuvanja na vremenskom programatoru.

1. Izaberite funkciju za kuvanje.
2. Dodirnite dok se simbol ne pojavi na ekranu vremena kuvanja.
3. Podesite vreme kuvanja koristeći tastere **+** / **-**.
 - » » Nakon podešavanja vremena kuvanja, simbol i indikator vremena će se trajno pojaviti na ekranu.
4. Stavite jelo u rernu i podesite temperaturu pomoću potencijometra za temperaturu. Kuvanje će početi.
 - » Vreme kuvanja počinje sa odbrojanjem na ekranu kada kuvanje počne i kada su svi delovi indikatora vremena uključeni. Podešeno vreme kuvanja je podeljeno na 4 jednaka dela i kada se vreme svakog dela završi, simbol tog dela se isključuje. Na taj način možete jednostavno da razumete odnos preostalog vremena kuvanja u odnosu na ukupno vreme kuvanja.

Podešavanje kraja vremena kuvanja na kasnije vreme:

Nakon podešavanja vremena kuvanja na vremenskom programatoru, kraj vremena kuvanja možete podesiti kasnije.

1. Izaberite funkciju za kuvanje.
2. Dodirnite dok se simbol ne pojavi na ekranu vremena kuvanja.
3. Podesite vreme kuvanja koristeći tastere **+** / **-**.
 - » » Kada se podesi vreme kuvanja, simbol će se trajno pojaviti na ekranu.
4. Dodirnite dok se simbol ne pojavi na ekranu za kraj vremena kuvanja.
5. Pritisnite tastere **+** / **-** da biste podesili kraj vremena kuvanja.

» Nakon podešavanja vremena kuvanja, simbol  plus simbol  i indikator vremena će se trajno pojaviti na ekranu. Kada kuvanje počne, simbol  će nestati.

6. Stavite jelo u rernu i podesite temperaturu pomoću potenciometra za temperaturu Kuvanje će početi.

» **Oven timer (Vremenski programator rerne) proračunava vreme početka kuvanja na osnovu vremena kraja kuvanja koje ste podesili.** Izabrani režim rada se aktivira kad dođe vreme za početak kuvanja i rerna je zagrejana do podešene temperature. Ta temperatura se održava do kraja vremena kuvanja.

» Vreme kuvanja počinje sa odbrojavanjem na ekranu kada kuvanje počne i kada su svi delovi indikatora vremena uključeni. Podešeno vreme kuvanja je podeljeno na 4 jednaka dela i kada se vreme svakog dela završi, simbol tog dela se isključuje. Na taj način možete jednostavno da razumete odnos preostalog vremena kuvanja u odnosu na ukupno vreme kuvanja.



7. Kad se proces kuvanja završi, na ekranu se pojavljuje "End" i oglašava se alarm.

8. Zvučno upozorenje se oglašava na 2 minute. Da prekinete zvučno upozorenje, samo pritisnite bilo koju tipku. Zvučno upozorenje će se prekinuti i pokazaće se trenutno vreme.

 Ako pritisnete bilo koji taster na kraju zvučnog upozorenja, rerna će ponovo početi da radi. Okrenite dugme za temperaturu i funkciju u položaj "0" (isključeno) da biste isključili rernu u cilju sprečavanja ponovnog uključivanja rerne na kraju upozorenja.

Aktiviranje zaključavanja tipke

Aktiviranjem funkcije zaključavanja tipke možete sprečiti da neko dira rernu.

1. Dodirnite  dok se simbol  ne pojavi na ekranu.



» „END" će se pojaviti na ekranu.

2. Pritisnite  da aktivirate zaključavanje tipke.

» Kad je zaključavanje tipke aktivirano, "On" se pojavljuje na ekranu i simbol  ostaje da svetli.

 Tipke rerne ne funkcionišu kad je aktivirano zaključavanje tipke. Zaključavanje tipke se neće otkazati u slučaju da nestane električne energije.

Da deaktivirate zaključavanje tipke

1. Dodirnite  dok se simbol  ne pojavi na ekranu.

» "On" će se pojaviti na ekranu.



2. Isključite zaključavanje tipke pritiskom na tipku .

» "END" je prikazano kada se isključi funkcija ključa.



Podešavanje buditnika

Vremenski programator rerne možete koristiti za bilo kakva upozorenja ili kao podsetnik odvojeno od programa kuvanja.

Budilnik nema uticaja na funkcije rerne. Koristi se samo za upozorenja. Na primer, ovo je korisno kad želite da okrenete hranu u rerni posle određenog vremena. Vremenski programator će se zvučno oglasiti na kraju podešenog vremena.

1. Dodirnite  dok se simbol  ne pojavi na ekranu.

 Maksimalno vreme alarma može da bude 23 sati i 59 minuta.

2. Podesite trajanje alarma sa tipkama  / .

i Tasteri za funkcije za ton alarma, sat, osvetljenost ekrana i tasteri za temperaturu treba da budu na poziciji 0 (isključeno).

» Posle podešavanja vremena alarma, simbol  će ostati da svetli i vreme alarma će se pojaviti na ekranu.



3. Na kraju vremena alarma, simbol  će početi da trepće i oglašiće se zvučno upozorenje.

Isključivanje alarma

1. Zvučno upozorenje se oglašava na 2 minute. Da prekinete zvučno upozorenje, samo pritisnite bilo koju tipku.

» Zvučno upozorenje će se prekinuti i pokazaće se trenutno vreme.



Otkazivanje alarma;

1. Da otkazete alarm, dodirnite  dok se simbol  ne pojavi na ekranu.

2. Pritisnite i zadržite tipku  dok se ne pokaže "00:00".

i Pokazaće se vreme alarma. Ako su uporedo podešeni vreme alarma i vreme kuvanja, pokazaće se ono vreme koje je kraće.

Promena tona alarma

1. Dodirnite  dok se simbol  ne pojavi na ekranu.



2. Podesite željeni zvuk upozorenja pomoću tastera  / .

3. Zvuk koji ste podesili će se ubrzo aktivirati.

» Izabrani ton alarma će biti prikazan kao "b-01", "b-02" ili "b-03" na ekranu.

Menjanje vremena u danu

Da biste promenili prethodno podešeno tačno vreme:

1. Dodirnite  dok se simbol  ne pojavi na ekranu.

2. Podesite vreme pomoću tastera  / .

3. Zvuk koji ste podesili će se ubrzo aktivirati.

Režim štednje

Možete da uštedite energiju u režimu štednje dok kuvate tako što ćete da podesite vreme kuvanja u remi.

Ovaj režim dovršava kuvanje pomoću unutrašnje temperature rerne isključivanjem grejača pre kraja vremena kuvanja.

Podešavanje režima štednje

1. Dodirujte simbol  dok se simbol **eco** ne pojavi na ekranu.

» "OFF" će se pojaviti na ekranu.

2. Omogućite režim štednje dodirivanjem tastera .

» Kad je zaključavanje tipke aktivirano, "On" se pojavljuje na ekranu i simbol **eco** ostaje da svetli.

Onemogućavanje režima štednje

1. Dodirujte simbol  dok se simbol **eco** ne pojavi na ekranu.



» "On" će se pojaviti na ekranu.

2. Onemogućite režim štednje dodirivanjem tastera .

» "END" je prikazano kada se isključi funkcija ključa.

Podešavanje osvetljenosti ekrana (Ova funkcija je opcionalna. Možda neće postojati kod vašeg proizvoda.)

1. Dodirujte  dok se na ekranu ne pojavi d-01 ili d-02 ili d-03 za podešavanje osvetljenosti.

2. Podesite željenu osvetljenost pomoću tastera  / .

» Zvuk koji ste podesili će se ubrzo aktivirati.

Tabela vremena kuvanja

i Vremena navedena u tabeli su orijentaciona. Ona mogu da budu različita u zavisnosti od vrste hrane, debljine, tipa i vašeg načina kuvanja.

Pečenje jela i pečenje mesa

i Prva polica ređe je donja polica.

Jelo	Broj plehova	Dodatak za upotrebu	Režim rada	Položaj police	Temperatura (°C)	Vreme kuvanja (približ. u min.)
Kolači u plehu	Jedan pleh	Standardni pleh*		3	180	25 ... 30
Kolač u kalupu	Jedan pleh	Kalup za kolač na žičanom roštiju**		2	180	40 ... 50
Sitni kolači	Jedan pleh	Standardni pleh*		3	160	25 ... 35
	Jedan pleh	Standardni pleh*		3	150	30 ... 40
	2 pleha	1-Pleh za pecivo* 3-Standardni pleh*		1 - 3	150	35 ... 50
	3 pleha	1-Standardni pleh* 3-Pleh za pecivo* 5-Duboki pleh*		1 - 3 - 5	150	35 ... 50
Koh	Jedan pleh	Okrugli kalup sa oprugom prečnika 26 cm na žičanom roštiju**		3	160	25 ... 35
	Jedan pleh	Okrugli kalup sa oprugom prečnika 26 cm na žičanom roštiju**		2	150	30 ... 40
	2 pleha	1-Okrugli kalup sa oprugom prečnika 26 cm na žičanom roštiju** 4-Okrugli kalup sa oprugom prečnika 26 cm na plehu za peciva**		1 - 4	150	35 ... 45
Kolači	Jedan pleh	Pleh za pecivo*		3	180	25 ... 30
	2 pleha	1-Pleh za pecivo* 3-Standardni pleh*		1 - 3	180	30 ... 40
	3 pleha	1-Pleh za pecivo* 3-Standardni pleh* 5-Duboki pleh*		1 - 3 - 5	180	35 ... 45
Pecivo od kvasnog testa	Jedan pleh	Standardni pleh*		2	200	30 ... 40
	2 pleha	1-Pleh za pecivo* 5-Standardni pleh*		1 - 5	200	45 ... 55
	3 pleha	1-Pleh za pecivo* 3-Standardni pleh* 5-Duboki pleh*		1 - 3 - 5	200	55 ... 65
Obogaćena peciva	Jedan pleh	Standardni pleh*		2	200	25 ... 35
	2 pleha	1-Pleh za pecivo* 3-Standardni pleh*		1 - 3	200	35 ... 45
	3 pleha	1-Pleh za pecivo* 3-Standardni pleh* 5-Duboki pleh*		1 - 3 - 5	190	45 ... 55
Kvasac	Jedan pleh	Standardni pleh*		2	200	35 ... 45

Jelo	Broj plehova	Dodatak za upotrebu	Režim rada	Položaj police	Temperatura (°C)	Vreme kuvanja (približ. u min.)
Lazanje	Jedan pleh	Staklena/metalna pravougaona posuda na žičanom roštiju**		2 - 3	200	30 ... 40
Pica	Jedan pleh	Standardni pleh*		2	200 ... 220	15 ... 20
Goveđe šnicle (cele) / Pečene	Jedan pleh	Standardni pleh*		3	25 min. 250/max, zatim 180 ... 190	100 ... 120
Jagneći but (musaka)	Jedan pleh	Standardni pleh*		3	25 min. 250/max, zatim 190	70 ... 90
	Jedan pleh	Standardni pleh*		3	25 min. 250/max, zatim 190	60 ... 80
Pečeno pile (1,8-2 kg)	Jedan pleh	Standardni pleh*		2	15 min. 250/max, zatim 180 ... 190	60 ... 80
	Jedan pleh	Standardni pleh*		2	15 min. 250/max, zatim 180 ... 190	60 ... 80
Čuretina (5.5 kg)	Jedan pleh	Standardni pleh*		1	25 min. 250/max, zatim 180 ... 190	150 ... 210
	Jedan pleh	Standardni pleh*		1	25 min. 250/max, zatim 180 ... 190	150 ... 210
Riba	Jedan pleh	Standardni pleh*		3	200	20 ... 30
	Jedan pleh	Standardni pleh*		3	200	20 ... 30

Za sve vrste jela predlažemo da prethodno zagrejete rernu.

* Ovi dodaci se možda ne isporučuju sa proizvodom.









** Ti dodaci se ne isporučuju sa proizvodom. To su komercijalno dostupni dodaci.

Tabela kuvanja za testiranje jela

Jela u ovoj tabeli kuvanja su pripremljena u suglasnosti sa EN 60350-1 kako bi se

olakšalo kontrolne institucije da testiraju produkte.

Jelo	Broj plehova	Dodatak za upotrebu	Režim rada	Položaj police	Temperatura (°C)	Vreme kuvanja (približ. u min.)
Shortbread	Jedan pleh	Standardni pleh*		3	140	20 ... 30
	Jedan pleh	Standardni pleh*		3	140	20 ... 30
	2 pleha	1-Standardni pleh* 3-Pleh za pecivo*		1 - 3	140	20 ... 30
	3 pleha	1-Standardni pleh* 3-Pleh za pecivo* 5-Duboki pleh*		1 - 3 - 5	140	25 ... 35
Sitni kolači	Jedan pleh	Standardni pleh*		3	160	25 ... 35
	Jedan pleh	Standardni pleh*		3	150	30 ... 40

Jelo	Broj plehova	Dodatak za upotrebu	Režim rada	Položaj police	Temperatura (°C)	Vreme kuvanja (približ. u min.)
	2 pleha	1-Pleh za pecivo* 3-Standardni pleh*		1 - 3	150	35 ... 50
	3 pleha	1-Standardni pleh* 3-Pleh za pecivo* 5-Duboki pleh*		1 - 3 - 5	150	35 ... 50
Koh	Jedan pleh	Okrugli kalup sa oprugom prečnika 26 cm na žičanom roštiju**		3	160	25 ... 35
	Jedan pleh	Okrugli kalup sa oprugom prečnika 26 cm na žičanom roštiju**		2	150	30 ... 40
	2 pleha	1-Okrugli kalup sa oprugom prečnika 26 cm na žičanom roštiju** 4-Okrugli kalup sa oprugom prečnika 26 cm na plehu za peciva**		1 - 4	150	35 ... 45
Pita od jabuke	Jedan pleh	Okruglu crnu metalnu posudu sa oprugom prečnika 20 cm na žičanom roštiju**		2	180	50 ... 60
	Jedan pleh	Okruglu crnu metalnu posudu sa oprugom prečnika 20 cm na žičanom roštiju**		2	170	50 ... 60
	2 pleha	1-Okruglu crnu metalnu posudu sa oprugom prečnika 20 cm na žičanom roštiju** 4-Okruglu crnu metalnu posudu sa oprugom prečnika 20 cm na plehu za peciva**		1 - 4	170	50 ... 60

Za sve vrste jela predlažemo da prethodno zagrejete rernu.

* Ovi dodaci se možda ne isporučuju sa proizvodom.

** Ti dodaci se ne isporučuju sa proizvodom. To su komercijalno dostupni dodaci.

Saveti za pečenje kolača

- Ako je kolač previše suv, povećajte temperaturu za nekih 10 i skratite vreme pečenja.
- Ako je kolač vlažan, koristite manje tečnosti ili smanjite temperaturu za 10°C.
- Ako je kolač previše taman na površini, stavite ga na donju policu, smanjite temperaturu i produžite vreme pečenja.
- Ako je dobro ispečen iznutra ali je lepljiv spolja koristite manje tečnosti, smanjite temperaturu i produžite vreme pečenja.

Saveti za pečenje testenine

- Ako je testenina previše suva, povećajte temperaturu za nekih 10 i skratite vreme pečenja. Naprskajte slojeve testa sosom od mleka, ulja, jaja i jogurta.
- Ako je testenini potrebno puno vremena da se ispeče, povedite računa da debljina testenine koju ste pripremili ne premašuje dubinu pleha.
- Ako gornji sloj testenine dobije braon boju, ali donji deo nije ispečen, postarajte se da se prevelika količina sosa koji ste upotrebili za testeninu ne nalazi na dnu testenine. Pokušajte da sos ravnomerno raspodelite na sve slojeve testa i na površinski sloj radi podjednagog pečenja.

i Testeninu pecite u skladu sa režimom i temperaturom, koji su navedeni u tablici kuvanja. Ako donji deo još uvek nije dovoljno ispečen, sledeći put pleh postavite za jedan nivo niže.

Saveti za kuvanje povrća

- Ako jelo sa povrćem izgubi tečnost i postane previše suvo, kuvajte ga u šerpi sa poklopcem radije nego u plehu. Zatvorene posude će zadržati sokove jela.
- Ako se jelo od povrća ne skuva, obarite povrće pre samog kuvanja ili ga pripremite kao konzerviranu hranu i stavite u rernu.

Kako rukovati roštiljem



Zatvorite vrata rerne za vreme pečenja na roštilju. Vruće površine mogu da prouzrokuju opekotine!

Switching on the grill (Paljenje roštilja)

1. Okrenite dugme za izbor funkcija na željeni simbol roštilja.
2. Zatim izaberite željenu temperaturu roštilja.
3. Ako je potrebno, izvršite predzagrevanje oko 5 minuta.
» Lampica temperature se pali.

Gašenje roštilja

1. Okrenite dugme za izbor funkcije u položaj "isključeno" (gore).



Hrana koja nije podesna za pečenje na roštilju može da prouzrokuje požar. Za pečenje na roštilju koristite samo hranu koja je prikladna za intenzivnu toplotu roštilja. Ne stavljajte hranu u zadnji deo rešetke za roštilj. To je najtoplija oblast, pa bi masna hrana mogla da se upali.

Tabela vremena kuvanja za pečenje roštilja

Pečenje na električnom roštilju

Hrana	Dodatak za upotrebu	Položaj police	Preporučena temperatura (°C)**	Vreme pečenja na roštilju (približno)
Riba	Žičani roštilj	4...5	250	20...25 min. #
Pileći fileti	Žičani roštilj	4...5	250	25...35 min.
Jagnjeći kotleti	Žičani roštilj	4...5	250	20...25 min.
Goveđe kremenadle	Žičani roštilj	4...5	250	25...30 min. #
Teleće kremenadle	Žičani roštilj	4...5	250	25...30 min. #
Tost-hleb *	Žičani roštilj	4	250	1...3 min.

zavisno od debljine

*Prethodno zagrevajte 5 minuta

**Ako se temperatura roštilja vašeg proizvoda ne može podesiti, roštilj će raditi na preporučenoj temperaturi.

Jela u ovoj tabeli kuvanja su pripremljena u suglasnosti sa EN 60350-1 kako bi se olakšalo kontrolne institucije da testiraju produkte.

Hrana	Dodatak za upotrebu	Položaj police	Temperatura (°C)	Vreme kuvanja (približ. u min.)
Tost hleb	Žičani roštilj	4	250	1...3 min.
Čufte (govedina) - 12 komadi	Žičani roštilj	4	250	25...35 min.

Okrenite hranu nakon 2/3 ukupnog vremena roštiljanja.

Predlažemo da obavite predzagrevanje 5 minuta za celokupnu hranu koja se peče na roštilju.

6 Održavanje i nega

Opšte informacije

Servisni vek trajanja ovog proizvoda će se produžiti i učestali problemi će se smanjiti ako se uređaj redovno čisti.

! Isključite proizvod iz struje pre nego što započnete radove održavanja i čišćenje. Postoji opasnost od električnog udara!

! Pre čišćenja sačekajte da se proizvod ohladi. Vruće površine mogu da prouzrokuju opekotine!

- Temeljno očistite uređaj posle svake upotrebe. Na taj način će biti moguće lakše ukloniti ostatke od kuvanja i izbeći njihovo obgorevanje pri sledećoj upotrebi uređaja.
- Za čišćenje nisu potrebna specijalna sredstva za čišćenje. Koristite toplu vodu i tečnost za pranje, meku tkaninu ili sunđer za čišćenje uređaja i obrišite ga suvom tkaninom.
- Uvek se pobrinite da višak tečnosti nakon čišćenja bude temeljno obrisano i prosipana tečnost odmah uklonjena brisanjem.
- Nemojte koristiti sredstva za čišćenje koja sadrže kiselinu ili hlorid za čišćenje nerđajućih ili inox površina i ručice. Koristite mekanu tkaninu sa tečnim deterdžentom (ne abrazivnim) za brisanje tih delova, vodeći računa da brišete u jednom smeru.

i Prilikom upotrebe nekih deterdženata ili sredstava za čišćenje mogla bi da se ošteti površina. Ne koristite agresivne deterdžente, praškove/tečnosti za čišćenje ili oštre predmete tokom čišćenja.

i Ne koristite paročistače za čišćenje uređaja da ne biste izazvali električni udar.

Čišćenje komandne table

Komandnu tablu i obrtnu dugmad očistite vlažnom krpom i osušite brisanjem.

i Ako je vaš proizvod opremljen tasterima/dugmadima, ne uklanjajte kontrolnu dugmad radi čišćenja komandne table. Komandna tabla može da se ošteti!

Čišćenje rerne

Za čišćenje bočnog zida (Razlikuje se u zavisnosti od modela uređaja.) (Ova funkcija je opcionalna. Možda neće postojati kod vašeg proizvoda.)

1. Uklonite prednji deo bočne police tako što ćete ga povući od bočnog zida.
2. Uklonite potpuno bočnu policu povlačeći je prema sebi.

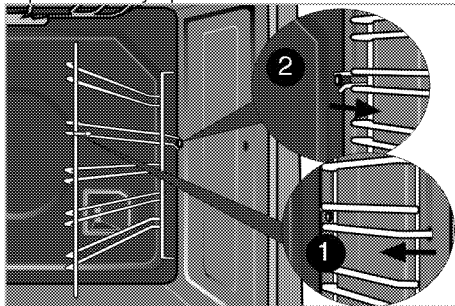

Katalitički zidovi

(Ova funkcija je opciona. Možda neće postojati kod vašeg proizvoda.)

Unutrašnji bočni zidovi (A) i/ili zadnji zid (B) vaše rerne mogu biti obloženi katalitičkim emajlom. Katalitički zidovi imaju svetlu mat boju i poroznu površinu. Katalitičke zidove rerne ne treba čistiti. Zahvaljujući svojoj perforiranoj strukturi, katalitičke površine apsorbiraju masnoću i kada se površina ispunji mašću, počinju da sjaje. U tom slučaju preporučuje se zamena delova.

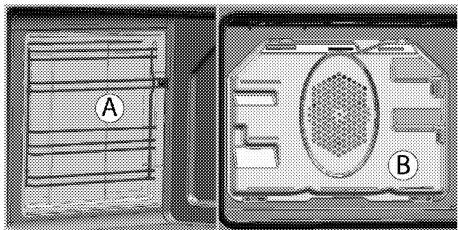

Lako čišćenje parom

Omogućava lako čišćenje zato što je prljavština (koja nije mnogo stara) omekšana parom koja se stvara u unutrašnjosti rerne i kapima vode kondenzovanim na unutrašnjim površinama rerne.

1. Uklonite sav pribor i dodatne delove iz unutrašnjosti rerne.
2. Sipajte 500 ml vode u pleh rerne i postavite pleh na drugu policu rerne.

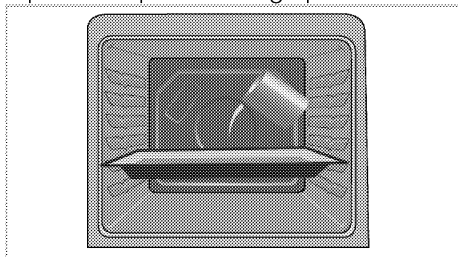

3. Podesite rernu da radi 25 minuta u režimu lako čišćenje parom na 100°C.
4. Otvorite vrata i obrišite unutrašnje površine rerne pomoću vlažnog sundera ili krpe.

5. Koristite toplu vodu i tečnost za pranje, meku tkaninu ili sunder za čišćenje uporne prljavštine i obrišite suvom tkaninom.

i U režimu lakog čišćenja parom, voda koja se stavlja u posudu za omekšavanje ostataka / prljavštine u unutrašnjosti pećnice će ispariti i kondenzovati u šupljini pećnice i unutrašnjem staklu vrata pećnice, tako da voda može kapati kada vrata rerne kapaju. je otvoren. Obrišite kondenzaciju čim se otvore vrata rerne.

Čišćenje vrata rerne

Za čišćenje vrata rerne, koristite toplu vodu i tečnost za pranje, meku tkaninu ili sunder za čišćenje uređaja i obrišite ga suvom tkaninom.

i Ne koristite oštra sredstva za čišćenje ili tvrde metalne strugače za čišćenje vrata rerne. Oni mogu da izgrebu površinu i unište staklo.

Skidanje vrata rerne

1. Otvorite prednja vrata (1).
2. Otvorite stezaljke na kućištu šarke (2) sa desne i leve strane prednjih vrata tako što ćete ih pritisnuti nadole, kao što je ilustrovano na slici.

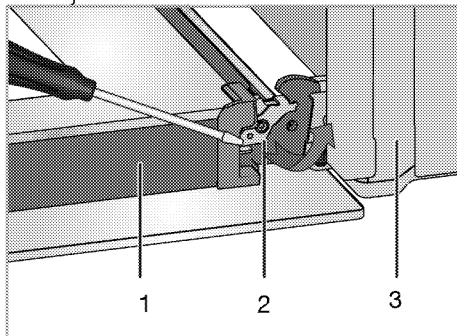

1 Vrata

- 2 Zaključavanje šarke(zatvorena pozicija)
- 3 Rerna
- 4 Zaključavanje šarke(otvorena pozicija)

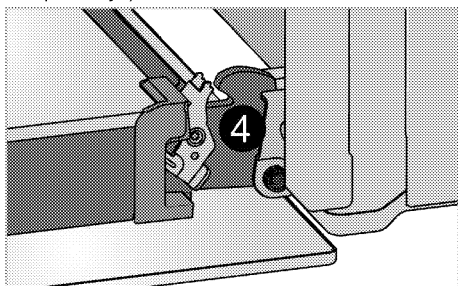

3. Prednja vrata pomerite do pola.

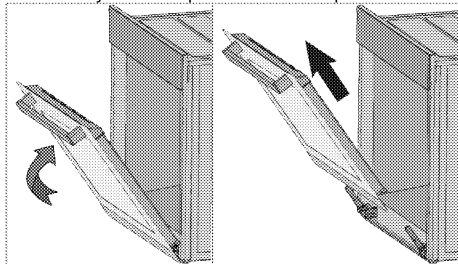

4. Skinite prednja vrata tako što ćete ih povući prema napred kako bi se oslobodila iz leve i desne šarke.

i Korake načinjene prilikom procesa skidanja treba ponoviti obrnutim redosledom da bi se instalirala vrata. Ne zaboravite da zatvorite stezaljke na kućištu šarke kada ponovo nameštate vrata.

Skidanje unutrašnjeg stakla na vratima

(Ova funkcija je opciona. Možda neće postojati kod vašeg proizvoda.)

Unutrašnja staklena ploča u vratima rerne može da se izvadi radi čišćenja.

1. Otvorite vrata rerne.

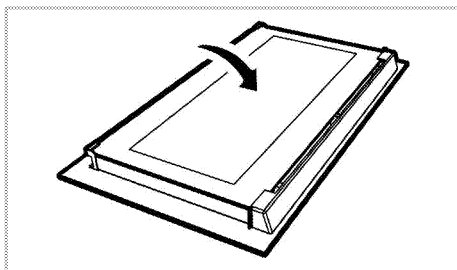

2. Povucite prema sebi i skinite plastični deo koji je instaliran na gornjem delu prednjih vrata.

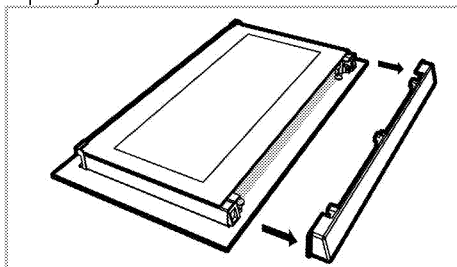

3. Kao što je prikazano na slici, lagano podignite najdublju staklenu ploču (1) u pravcu **A** i izvucite je u pravcu **B**.

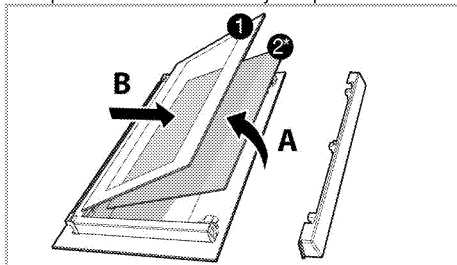

1 Najdublja staklena ploča
2* Unutrašnja staklena ploča (Možda neće postojati kod vašeg proizvoda.)

4. Ako je vaš proizvod opremljen unutrašnjom staklenom pločom(2); Ovaj postupak ponovite za uklanjanje unutrašnje staklene ploče (2).
5. Prvi korak u montiranju vrata je reinstaliranje unutrašnje staklene ploče (2). Stavite ožlebljeni ugao staklene ploče tako da se osloni na ožlebljeni ugao plastičnog žleba. (Ako je vaš

proizvod opremljen unutrašnjom staklenom pločom). Unutrašnja staklena ploča (2) mora biti instalirana u plastični žleb uz najdublju staklenu ploču (1).

6. Prilikom instaliranja najdublje staklene ploče (1), uverite se da je štampana strana ploče okrenuta prema unutrašnjoj staklenoj ploči. Važno je da uglavite donji ugao najdublje staklene ploče (1) u donji plastični žleb.

7. Gurajte plastični deo prema okviru dok ne čujete "klik".

Zamena sijalice u rerni

! Pre zamene sijalice u rerni uverite se da je proizvod isključen iz struje i ohlađen radi izbegavanja opasnosti od električnog udara. Vruće površine mogu da prouzrokuju opekotine!

i U ovoj pećnici se koristi žarulja sa žarnom niti snage manje od 40 V, visine manje od 60 mm, prečnika manje od 30 mm ili halogena lampa sa utičnicom tipa G9, snage manje od 60 V. Lampe su pogodne za rad na temperaturama iznad 300 ° C. Lampe za pećnicu možete nabaviti od ovlašćenog servisera ili tehničara sa licencom.

i Položaj sijalice može da se razlikuje od položaja na slici.

i Lampa koja se koristi u ovom uređaju nije prikladna za osvetljavanje prostorije u domaćinstvu. Namena ove lampe je da pomogne korisniku da vidi hranu.

i Lampe u ovom uređaju moraju da izdržavaju ekstremne fizičke uslove, kao što su temperature preko 50 °C.

Ako vaša rerna ima okruglu sijalicu:

1. Isključite proizvod iz struje.
2. Stakleni poklopac okrećite suprotno smeru kazaljke na satu da biste je uklonili.

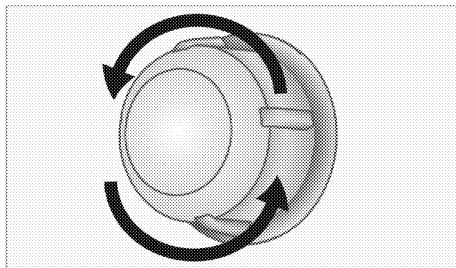

3. Ako je tip lampe u vašoj rerni tip (A) kao što je prikazano na slici u nastavku, uklonite je tako što ćete je rotirati kao što je prikazano i zamenite je. Ako je u pitanju tip lampe (B), povucite je i uklonite je kao što je prikazano na slici i zamenite je.

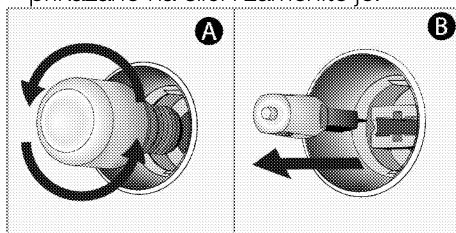

4. Namestite stakleni poklopac.

7 Otklanjanje kvarova

Rerna može da ispušta paru za vreme upotrebe.

- Normalno je da se u toku rada javlja para. >>> *To nije kvar.*

Proizvod emituje metalni zvuk (buka) tokom grejanja i hlađenja.

- Kada se zagrevaju metalni delovi, može doći do njihovog širenja i izvešnog šuma. >>> *To nije kvar.*

Proizvod ne radi.

- Osigurač napajanja je pregoreo ili je reagovao. >>> *Proverite osigurače u kutiji sa osiguračima. Ako je potrebno, zamenite ih ili ih resetujte.*
- Proizvod nije priključen na (uzemljenu) utičnicu. >>> *Proverite utikač.*

Sijalica u rerni ne radi.

- Sijalica u rerni je u kvaru. >>> *Zamenite sijalicu u rerni.*
- Nema struje. >>> *Proverite da li ima struje. Proverite osigurače u kutiji sa osiguračima. Ako je potrebno, zamenite ih ili ih resetujte.*

Rerna ne greje.

- Funkcija i/ili temperatura nisu podešeni. >>> *Podesite funkciju i temperaturu pomoću obrtnog dugmeta/tastera za izbor funkcije i/ili temperature.*
- Kod modela opremljenim tajmerom, tajmer nije podešen. >>> *Podesite vreme. (Kod proizvoda sa mikrotalasnom rernom, tajmer kontroliše samo mikrotalasnu rernu.)*
- Nema struje. >>> *Proverite da li ima struje. Proverite osigurače u kutiji sa osiguračima. Ako je potrebno, zamenite ih ili ih resetujte.*

(Kod modela sa tajmerom) Displej sata trepće ili prikazuje simbol sata.

- Nestajala je struja. >>> *Podesite vreme / isključite i ponovo uključite proizvod.*



Posavetujte se sa ovlašćenim serviserom ili distributerom na mestu kupovine proizvoda ukoliko ne možete da rešite problem i pored primene navedenih uputstava. Nikad ne pokušavajte sami da popravite neispravan proizvod.

Ovaj dokument je originalno proizveden i objavljen od strane proizvođača, brenda Beko, i preuzet je sa njihove zvanične stranice. S obzirom na ovu činjenicu, Tehnoteka ističe da ne preuzima odgovornost za tačnost, celovitost ili pouzdanost informacija, podataka, mišljenja, saveta ili izjava sadržanih u ovom dokumentu.

Napominjemo da Tehnoteka nema ovlašćenje da izvrši bilo kakve izmene ili dopune na ovom dokumentu, stoga nismo odgovorni za eventualne greške, propuste ili netačnosti koje se mogu naći unutar njega. Tehnoteka ne odgovara za štetu nanесenu korisnicima pri upotrebi netačnih podataka. Ukoliko imate dodatna pitanja o proizvodu, ljubazno vas molimo da kontaktirate direktno proizvođača kako biste dobili sve detaljne informacije.

Za najnovije informacije o ceni, dostupnim akcijama i tehničkim karakteristikama proizvoda koji se pominje u ovom dokumentu, molimo posetite našu stranicu klikom na sledeći link:

<https://tehnoteka.rs/p/beko-ugradni-set-bse24322b-akcija-cena/>