

Uputstvo za upotrebu

VOX inverter klima IVA5 - 24JR



Tehnoteka je online destinacija za upoređivanje cena i karakteristika bele tehnike, potrošačke elektronike i IT uređaja kod trgovinskih lanaca i internet prodavnica u Srbiji. Naša stranica vam omogućava da istražite najnovije informacije, detaljne karakteristike i konkurentne cene proizvoda.

Posetite nas i uživajte u ekskluzivnom iskustvu pametne kupovine klikom na link:

<https://tehnoteka.rs/p/vox-inverter-klima-iva5-24jr-akcija-cena/>



GBR

SRB

IVA1-12IR

IVA1-18IR

IVA1-24IR

IVA5-12JR

IVA5-18JR

IVA5-24JR

**OPERATING INSTRUCTIONS
SPLIT TYPE WALL MOUNTED AIR-CONDITIONER**

**UPUTSTVO ZA UPOTREBU
ZIDNI SPLIT SISTEM KLIMA UREĐAJ**

Owner's Manual

Split type wall mounted
air-conditioner

For model

IVA1-12IR

IVA1-18IR

IVA1-24IR

IVA5-12JR

IVA5-18JR

IVA5-24JR

- 
- ※ Please read this owner's manual carefully and thoroughly before operating the unit!
 - ※ Take care of this manual for future reference.

CONTENTS

Operation and maintenance

Warning	1
Safety Precautions	2
Notices for use	7
Names of each part	9
Clean and care	10
Troubleshooting	12

Installation service





Notices for installation	14
Install indoor unit	18
Install outdoor unit	21
Check after installation and test operation	24
Maintenance Notice	25

Note: All the pictures in this manual are just schematic diagrams, the actual is the standard.

Warning: This air conditioner uses R32 flammable refrigerant.

Notes: Air conditioner with R32 refrigerant, if roughly treated, may cause serious harm to the human body or surrounding things.

- * The room space for the installation, use, repair, and storage of this air conditioner should be greater than 5m².
- * Air conditioner refrigerant can not charge more than 1.7kg.
- * Do not use any methods to speed up defrost or to clean frosty parts except for particular recommended by manufacturer.
- * Not pierce or burn air conditioner, and check the refrigerant pipeline whether be damaged.
- * The air conditioner should be stored in a room without lasting fire source, for example, open flame, burning gas appliance, working electric heater and so on.
- * Notice that the refrigerant may be tasteless.
- * The storage of air conditioner should be able to prevent mechanical damage caused by accident.
- * Maintenance or repair of air conditioners using R32 refrigerant must be carried out after security check to minimize risk of incidents.
- * Air conditioner must be installed with stop valve cover.
- * Please read the instruction carefully before installing, using and maintaining.

Symbol	Note	Explanation
	WARNING	This symbol shows that this appliance uses a flammable refrigerant. If the refrigerant is leaked and exposed to an external ignition source, there is a risk of fire.
	CAUTION	This symbol shows that the operation manual should be read carefully.
	CAUTION	This symbol shows that a service personnel should be handling this equipment with reference to the installation manual.
	CAUTION	This symbol shows that information is available such as the operating manual or installation manual.

Safety precautions

Incorrect installation or operation by not following these instructions may cause harm or damage to people, properties, etc.

The seriousness is classified by the following indications:

WARNING

This symbol indicates the possibility of death or serious injury.

CAUTION

This symbol indicates the possibility of injury or damage to properties.

WARNING

This appliance can be used by children aged from 8 years and above and persons with reduced physical, sensory or mental capabilities or lack of experience and knowledge if they have been given supervision or instruction concerning use of the appliance in a safe way and understand the hazards involved. Children shall not play with the appliance. Cleaning and user maintenance shall not be made by children without supervision.

(Only for the AC with CE-MARKING)

This appliance is not intended for use by persons (including children) with reduced physical, sensory or mental capabilities, or lack of experience and knowledge, unless they have been given supervision or instruction concerning use of the appliance by a person responsible for their safety. Children should be supervised to ensure that they do not play with the appliance.

(Except for the AC with CE-MARKING)

Safety Precautions

The air conditioner must be grounded. Incomplete grounding may result in electric shocks.



Do not connect the earth wire to the gas pipeline, water pipeline, lightning rod, or telephone earth wire.

Always switch off the device and cut the power supply when the unit is not in use for long time so as to ensure safety.



Take care not let the remote control and the indoor unit watered or being too wet.

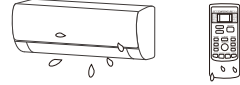

NO!

Otherwise, it may cause short circuit.

If the power supply cable is damaged, it must be replaced by the manufacture or its service agent or a similar qualified person.



Don't cut off main power switch during operating or with wet hands.



It may cause electric shock.

Don't share the socket with other electric appliance.

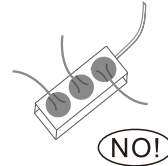

Otherwise, it may cause electric shock even fire and explosion.

Always switch off the device and cut the power supply before performing any maintenance or cleaning.



Otherwise, it may cause electric shock or damage.

Don't pull the power cable .



The damage of pulling power cord will cause serious electric shock.

A warning that ducts connected to an appliance shall not contain an ignition source.

Safety precautions

Don't install air conditioner in a place where there is flammable gas or liquid. The distance between them should above 1m.

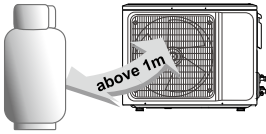

It may cause fire even explosion.

Don't use liquid or corrosive cleaning agent wipe the air conditioner and sprinkle water or other liquid either.

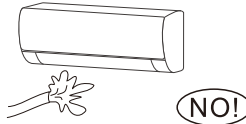

Doing this may cause electric shock or damage to the unit.

Don't attempt to repair the air conditioner by yourself.

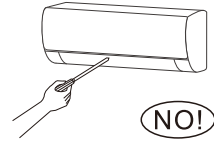

Incorrect repairs may cause fire or explosion. Contact a qualified service technician for all service requirement.

Don't use air conditioner in lightning storm weather.

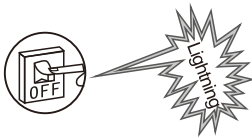

Power supply should be cut in time to prevent the occurrence of danger.

Don't put hands or any objects into the air inlets or outlets.

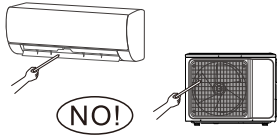

This may cause personal injury or damage to the unit.

Please note whether the installed stand is firm enough or not.

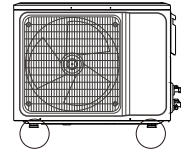

If it is damaged, it may lead to the fall of the unit and cause the injury.

Don't block air inlet or air outlet.

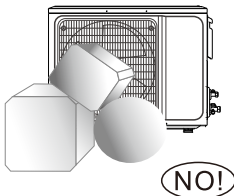

Otherwise, the cooling or heating capacity will be weakened, even cause system stop operating.

Don't let the air conditioner blow against the heater appliance.

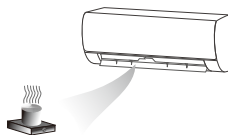

Otherwise it will lead to incomplete combustion, thus causing poisoning.

The appliance shall be installed in accordance with national wiring regulations.

An earth leakage breaker with rated capacity must be installed to avoid possible electric shocks.

Safety Precautions

This product contains fluorinated greenhouse gases.

Refrigerant leakage contributes to climate change.

Refrigerant with lower global warming potential (GWP) would contribute less to global warming than a refrigerant with higher GWP, if leaked to the atmosphere. This appliance contains a refrigerant fluid with a GWP equal to [675]. This means that if 1 kg of this refrigerant fluid would be leaked to the atmosphere, the impact on global warming would be [675] times higher than 1 kg of CO₂, over a period of 100 years. Never try to interfere with the refrigerant circuit yourself or disassemble the product yourself and always ask a professional.

Ensure no following objects under the indoor unit:

- 1. microwaves, ovens and other hot objects.**
- 2. computers and other high electrostatic appliances.**
- 3. sockets that plug frequently.**

The joints between indoor and outdoor unit shall not be reused, unless after re-flaring the pipe.

The specification of the fuse are printed on the circuit board, such as: 3.15A/250V AC, etc.

WEEE Warning

Meaning of crossed out wheeled dustbin:

Do not dispose of electrical appliances as unsorted municipal waste, use separate collection facilities.

Contact your local government for information regarding the collection systems available.

If electrical appliances are disposed of in landfills or dumps, hazardous substances can leak into the groundwater and get into the food chain, damaging your health and well-being.

When replacing old appliances with new ones, the retailer is legally obligated to take back your old appliance for disposal at least free of charge.



Safety Precautions

CAUTION

Don't open the windows and doors for long time when the air conditioner is running.

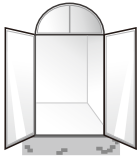

Otherwise, the cooling or heating capacity will be weakened.

Don't stand on the top of the outdoor unit or place heavy things on it.

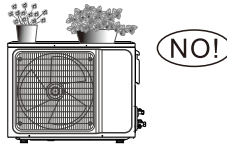

This could cause personal injuries or damage the unit.

Don't use the air conditioner for other purposes, such as drying clothes, preserving foods, etc.

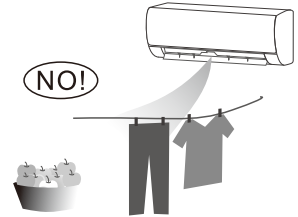

Don't apply the cold air to the body for a long time.

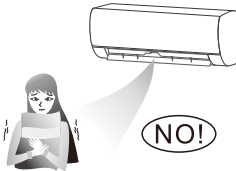

It will deteriorate your physical conditions and cause health problems.

Set the suitable temperature.

It is recommended that the temperature difference between indoor and outdoor temperature should not be too large.

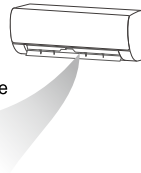

Appropriate adjustments of the setting temperature can prevent the waste of electricity.

If your air conditioner is not fitted with a supply cord and a plug, an anti-explosion all-pole switch must be installed in the fixed wiring and the distance between contacts should be no less than 3.0 mm.

If your air conditioner is permanently connected to the fixed wiring, a anti-explosion residual current device (RCD) having rated residual operating current not exceeding 30 mA should be installed in the fixed wiring.

The power supply circuit should have leakage protector and air switch of which the capacity should be more than 1.5 times of the maximum current.

Regarding the installation of the air conditioners, please refer to the below paragraphs in this manual.

The conditions of unit can't normally run

* Within the temperature range provided in following table, the air conditioner may stop running and other anomalies may arise.

Cooling	Outdoor	>43°C (Apply to T1)
		>52°C (Apply to T3)
	Indoor	<18°C
Heating	Outdoor	>24°C
		<-7°C
	Indoor	>27°C

- * When the temperature is too high, the air conditioner may activate the automatic protection device, so that the air conditioner could be shut down.
- * When the temperature is too low, the heat exchanger of the air conditioner may freeze, leading to water dripping or other malfunction.
- * In long-term cooling or dehumidification with a relative humidity of above 80% (doors and windows are open), there may be water condenses or dripping near the air outlet.
- * T1 and T3 refer to ISO 5151.

Notes for heating

- * The fan of the indoor unit will not start running immediately after the heating is started to avoid blowing out cool air.
- * When it is cold and wet outside, the outdoor unit will develop frost over the heat exchanger which will increase the heating capacity. Then the air conditioner will start defrost function.
- * During defrost, the air conditioner will stop heating for about 5-12 minutes.
- * Vapor may come out from the outdoor unit during defrost. This is not a malfunction, but a result of fast defrost.
- * Heating will resume after defrost is complete.

Notes for turning off

- * When the air conditioner is turned off, the main controller will automatically decide whether to stop immediately or after running for dozens of seconds with lower frequency and lower air speed.

Notices for use

Emergency operation

- * If the remote controller is lost or broken, use force switch button to operate the air conditioner.
- * If this button is pushed with the unit OFF, the air conditioner will operate in Auto mode.
- * If this button is pushed with the unit ON, the air conditioner will stop running.

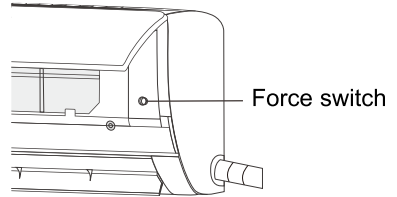

Airflow direction adjustment

1. Use up-down swing and left-right swing buttons on the remote controller to adjust the airflow direction. Refer to the operation manual of the remote controller for detail.
2. For models without left-right swing function, the fins has to be moved manually.

**Note: Move the fins before the unit is in operation, or your finger might be injured.
Never place your hand into the air inlet or outlet when the air conditioner is in operation.**

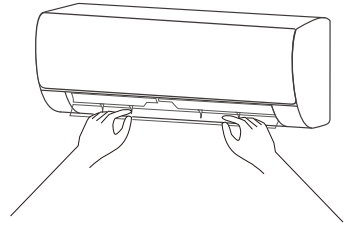

Specific caution

1. Open front panel of the indoor.
2. The connector(as Fig) can not touch the terminal board, and is positioned as shown in Fig.

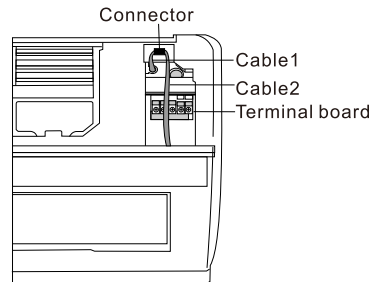

Names of each part

Indoor unit

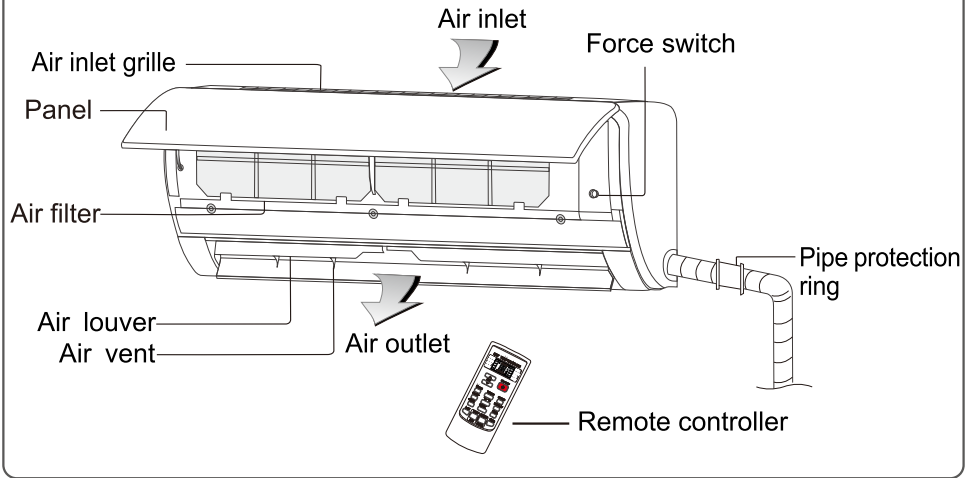

Outdoor unit

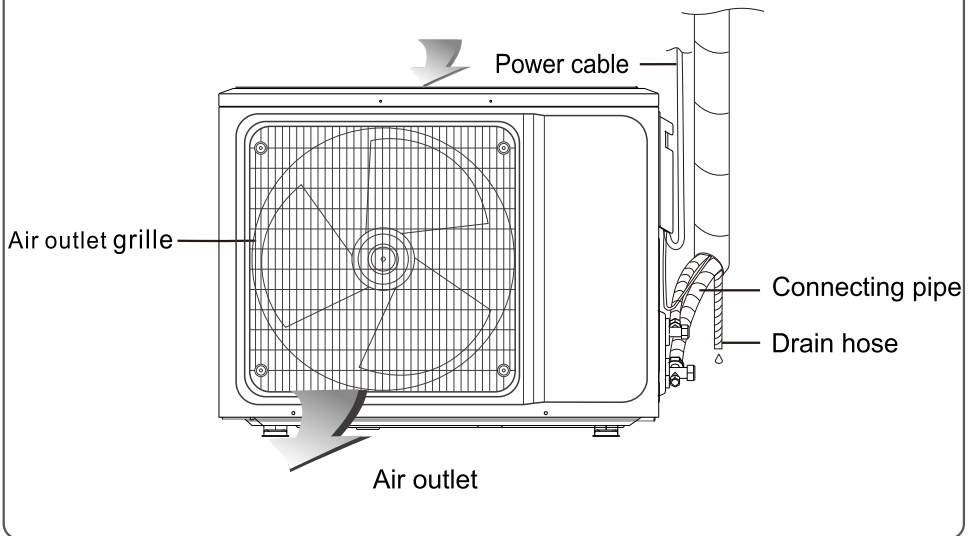

Note: All the pictures in this manual are just schematic diagrams, the actual is the standard. Plug, WIFI function, Negative-ion function, and Vertical and horizontal swing function both are optional, the actual unit shall prevail.

Clean and care

Warning

- Before the cleaning of the air conditioner, it must be shut down and the electricity must be cut off for more than 5 minutes, otherwise there might be the risk of electric shocks.
- Do not wet the air conditioner, which can cause an electric shock. Make sure not to rinse the air conditioner with water under any circumstances.
- Volatile liquids such as thinner or gasoline will damage the air conditioner housing, therefore please clean the housing of air conditioner only with soft dry cloth and damp cloth moistened with neutral detergent.
- In the course of the using, pay attention to cleaning the filter regularly, to prevent the covering of dust which may affect the effect. If the service environment of the air conditioner is dusty, correspondingly increase the number of times of cleaning. After removing the filter, do not touch the fin part of the indoor unit with the finger, and no force to damage the refrigerant pipeline.

Clean the panel

When the panel of the indoor unit is contaminated, clean it gently with a wrung towel using tepid water below 40°C, and do not remove the panel while cleaning.

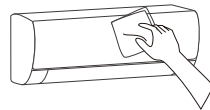

Clean the air filter

■ Remove the air filter

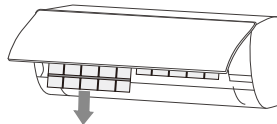
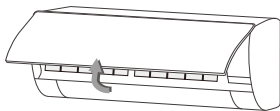

1. Use both hands to open the panel for an angle from both ends of the panel in accordance with the direction of the arrow.
2. Release the air filter from the slot and remove it.

■ Clean the Air Filter

Use a vacuum cleaner or water to rinse filter, and if the filter is very dirty (for example, with greasy dirt), clean it with warm water (below 45 °C) with mild detergent dissolved in, and then put the filter in the shade to dry in the air.

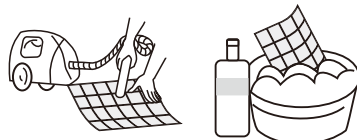

■ Mount the Filter

1. Reinstall the dried filter in reverse order of removal, then cover and lock the panel.

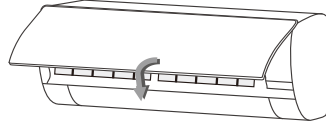
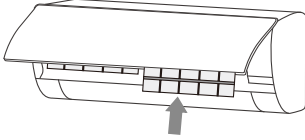

Check before use

1. Check whether all the air inlets and outlets of the units are unblocked.
2. Check whether there is blocking in the water outlet of the drain pipe, and immediately clean it up if any.
3. Check the ground wire is reliably grounded.
4. Check whether the remote control batteries are installed, and whether the power is sufficient.
5. Check whether there is damage in the mounting bracket of the outdoor unit, and if any, please contact our local service center.

Maintain after use

1. Cut off the power source of the air conditioner, turn off the main power switch and remove the batteries from the remote controller.
2. Clean the filter and the unit body.
3. Remove the dust and debris from the outdoor unit.
4. Check whether there is damage in the mounting bracket of the outdoor unit, and if any, please contact our local service center.

Troubleshooting

⚠ Caution

* Do not repair the air conditioner by yourself as wrong maintenance may cause electric shock or fire or explode, please contact the authorized service center and let the professionals conduct the maintenance, and checking the following items prior to contacting for maintenance can save your time and money.

Phenomenon

Troubleshooting

The air conditioner does not work.

- There might be power outages. → Wait until power is restored.
- Power plug may be loose out from the socket.
→ The plug in the plug tightly.
- Power switch fuse may blow. → Replace the fuse.
- The time for timing boot is yet to come.
→ Wait or cancel the timer settings.

The air conditioner can't run after the immediate start-up after it is shut down.

- If the air conditioner is turned on immediately after it is turned off, the protective delay switch will delay the operation for 3 to 5 minutes.

The air conditioner stops running after it starts up for a while.

- May reach the setting temperature.
→ It is a normal function phenomenon.
- May be at a defrosting state. → It will automatically restore and run again after defrosting.
- Shutdown Timer may be set.
→ If you continue to use, please turn it on again.

The wind blows out, but the cooling/heating effect is not good.

- Excessive accumulation of dust on filter, blocking at air inlet and outlet, and the excessively small angle of the louver blades all will affect the cooling and heating effect.
→ Please clean the filter, remove the obstacles at the air inlet and outlet and regulate the angle of the louver blades.
- Poor cooling and heating effect caused by doors and windows opening, and unclosed exhaust fan.
→ Please close the doors, windows, the exhaust fan, etc.
- Auxiliary heating function is not turned on while heating, which may lead to poor heating effect.
→ Turn on the auxiliary heating function.
(only for models with auxiliary heating function)
- Mode setting is incorrect, and the temperature and wind speed settings are not appropriate.
→ Please re-select the mode, and set the appropriate temperature and wind speed.

The indoor unit blows out odor.

- The air conditioner itself does not have undesirable odor. If there is odor, it may be due to accumulation of the odor in the environment.
→ Clean the air filter or activate the cleaning function.

Troubleshooting

There is sound of running water during the running of air conditioner.

- When the air conditioner is started up or stopped, or the compressor is started up or stopped during the running, sometimes the "hissing" sound of running water can be heard. → This is the sound of the flow of the refrigerant, not a malfunction.

A slight "click" sound is heard at the of start-up or shut-down.

- Due to temperature changes, panel and other parts will swell, causing the sound of friction.
→ This is normal, not a fault.

The indoor unit makes abnormal sound.

- The sound of fan or compressor relay switched on or off.
- When the defrosting is started or stop running, it will sound.
→ That is due to the refrigerant flowed to reverse direction. They are not malfunctions.
- Too much dust accumulation in the air filter of the indoor unit may result in fluctuation of the sound.
→ Clean the air filters in time.
- Too much air noise when "Strong wind" is turned on.
→ This is normal, if feeling uncomfortable, please deactivate the "Strong wind" function.

There are water drops over the surface of the indoor unit.

- When ambient humidity is high, water drops will be accumulated around the air outlet or the panel, etc.
→ This is a normal physics phenomenon.
- Prolonged cooling run in open space produces water drops.
→ Close the doors and windows.
- Too small opening angle of the louver blades may also result in water drops at the air inlet.
→ Increase the angle of the louver blades.

During the cooling operation, the indoor unit outlet sometimes will blow out mist.

- When the indoor temperature and humidity are high, it happens sometimes.
→ This is because the indoor air is cooled rapidly. After it runs for some time, the indoor temperature and humidity will be reduced and the mist will disappear.



Immediately stop all operations and cut off the power supply, contact our Service center locally in following situations.

- ▲ Hear any harsh sound or smell any awful odor during running.
- ▲ Abnormal heating of power cord and plug occurs.
- ▲ The unit or remote controller has any impurity or water.
- ▲ Air switch or leakage protection switch is often disconnected.

Notices for installation

🔔 Important Notices

- Before installing, please contact with local authorized maintenance center, if unit is not installed by the authorized maintenance center, the malfunction may not solved, due to discommodious contact.
- The air conditioner must be installed by professionals according to the national wiring rules and this manual.
- Refrigerant leak test must be made after installation.
- To move and install air conditioner to another place, please contact our local special service center.

📦 Unpacking Inspection

- Open the box and check air conditioner in area with good ventilation (open the door and window) and without ignition source. Note: Operators are required to wear anti-static devices.
- It is necessary to check by professional whether there is refrigerant leakage before opening the box of outdoor machine; stop installing the air conditioner if leakage is found.
- The fire prevention equipment and anti-static precautions shall be prepared well before checking. Then check the refrigerant pipeline to see if there is any collision traces, and whether the outlook is good.

🛑 Safety Principles for Installing Air Conditioner

- Fire prevention device shall be prepared before installation.
- Keep installing site ventilated. (open the door and window)
- Ignition source, smoking and calling is not allowed to exist in area where R32 refrigerant located.
- Anti-static precautions in necessary for installing air conditioner, e.g. wear pure cotton clothes and gloves.
- Keep leak detector in working state during the installation.
- If R32 refrigerant leakage occurs during the installation, you shall immediately detect the concentration in indoor environment until it reaches a safe level. If refrigerant leakage affects the performance of the air conditioner, please immediately stop the operation, and the air conditioner must be vacuumed firstly and be returned to the maintenance station for processing.
- Keep electric appliance, power switch, plug, socket, high temperature heat source and high static away from the area underneath sidelines of the indoor unit.
- The air conditioner shall be installed in an accessible location to installation and maintenance, without obstacles that may block air inlets or outlets of indoor/outdoor units, and shall keep away from heat source, inflammable or explosive conditions.

Notices for installation

- When installing or repairing the air conditioner and the connecting line is not long enough, the entire connecting line shall be replaced with the connecting line of the original specification; extension is not allowed.
- Use new connection pipe, unless re-flaring the pipe.

Requirements For Installation Position

- Avoid places of inflammable or explosive gas leakage or where there are strongly aggressive gases.
- Avoid places subject to strong artificial electric/magnetic fields.
- Avoid places subject to noise and resonance.
- Avoid severe natural conditions (e.g. heavy lampblack, strong sandy wind, direct sunshine or high temperature heat sources).
- Avoid places within the reach of children.
- Shorten the connection between the indoor and outdoor units.
- Select where it is easy to perform service and repair and where the ventilation good.
- The outdoor unit shall not be installed in any way that could occupy an aisle, stairway, exit, fire escape, catwalk or any other public area.
- The outdoor unit shall be installed as far as possible from the doors and windows of the neighbors as well as the green plants.

Installation environment inspection

- Check nameplate of outdoor unit to make sure whether the refrigerant is R32.
- Check the floor space of the room. The space shall not be less than usable space(5m²) in the specification. The outdoor unit shall be installed at a well-ventilated place.
- Check the surrounding environment of installation site: R32 shall not be installed in the enclosed reserved space of a building.
- When using electric drill to make holes in the wall, check first whether there is pre-buried pipeline for water, electricity and gas.

Requirements of the mounting structure

- The mounting rack must meet the relevant national or industrial standards in terms of strength with welding and connection areas rustproofed.
- The mounting rack and its load carry surface shall be able to withstand 4 times or above the weight of the unit, or 200kg, whichever is heavier.

Notices for installation

- The mounting rack of the outdoor unit shall be fastened with expansion bolt.
- Ensure the secure installation regardless of what type of wall on which it is installed, to prevent potential dropping that could hurt people.

Electrical Safety Requirements

- Be sure to use the rated voltage and air conditioners dedicated circuit for the power supply, and the power cord diameter must meet the national requirements.
- When the maximum current of air conditioner is $\geq 16A$, it must use the air switch or leakage protection switch equipped with protection devices.
- The operating range is 90%-110% of the local rated voltage. But insufficient power supply malfunction, electrical shock, or fire. If the voltage instability, proposed to increase the voltage regulator.
- The minimum clearance between the air conditioner and the combustibles is 1.5 m.
- The interconnection cord connect the indoor and outdoor units. You must first choose the right cable size before preparing it for connection.
- Cable Types: Outdoor Power Cable: H07RN-F or H05RN-F; Interconnection cord: H07RN-F or H05RN-F;
- Minimum Cross-Sectional Area of Power cable and interconnection cord.

North America

Appliance Amps(A)	AWG
10	18
13	16
18	14
25	12
30	10
40	8

Other Regions

Rated Current of Appliance(A)	Nominal Cross-Sectional Area(mm ²)
>3 and ≤ 6	0.75
>6 and ≤ 10	1
>10 and ≤ 16	1.5
>16 and ≤ 25	2.5
>25 and ≤ 32	4
>32 and ≤ 40	6

- The size of the interconnection cord, power cable, fuse, and switch needed is determined by the maximum current of the unit. The maximum current is indicated on the nameplate located on the side panel of the unit. Refer to this nameplate to choose the right cable, fuse, or switch.
- Note: Core number of cable refer to the detailed wiring diagram adhered on the unit which you purchased.

Notices for installation

Requirements for operations at raised height

- When carrying out installation at 2m or higher above the base level, safety belts must be worn and ropes of sufficient strength be securely fasten to the outdoor unit, to prevent falling that could cause personal injury or death as well as property loss.

Grounding Requirements

- The air conditioner is the class I electrical appliance and must ensure a reliable grounding.
- Do not connect the grounding wire to a gas pipe, water pipe, lightning rod, telephone line, or a circuit poorly grounded to the earth.
- The grounding wire is specially designed and shall not be used for other purpose, nor shall it be fastened with a common tapping screw.
- Interconnection cord diameter should be recommended as per instruction manual ,and with type O terminal that meet local standards (internal diameter of type O terminal needs to match the screw size of the unit, no more than 4.2mm). After installation, check the screws whether have been fixed effectively, and there is no risk of loosening.

Others

- The connection method of the air conditioner and the power cord and the interconnection method of each independent element shall be subject to the wiring diagram affixed to the machine.
- The model and rating value of the fuse shall be subject to the silkscreen on corresponding controller or fuse sleeve.

Packing list

Packing list of the indoor unit

Name	Quantity	Unit
Indoor Unit	1	Set
Remote Controller	1	PC
Batteries (7#)	2	PC
Owner's manual	1	Set
Drain pipe	1	PC

Packing list of the outdoor unit

Name	Quantity	Unit
Outdoor Unit	1	Set
Connecting pipe	2	PC
Plastic Strap	1	ROLL
Pipe Protection Ring	1	PC
Luting (putty)	1	PACKET

NOTE: All accessories shall be subject to actual packaging material, and if there is any difference, please understand.

Install Indoor Unit

Dimension drawing of indoor unit installation

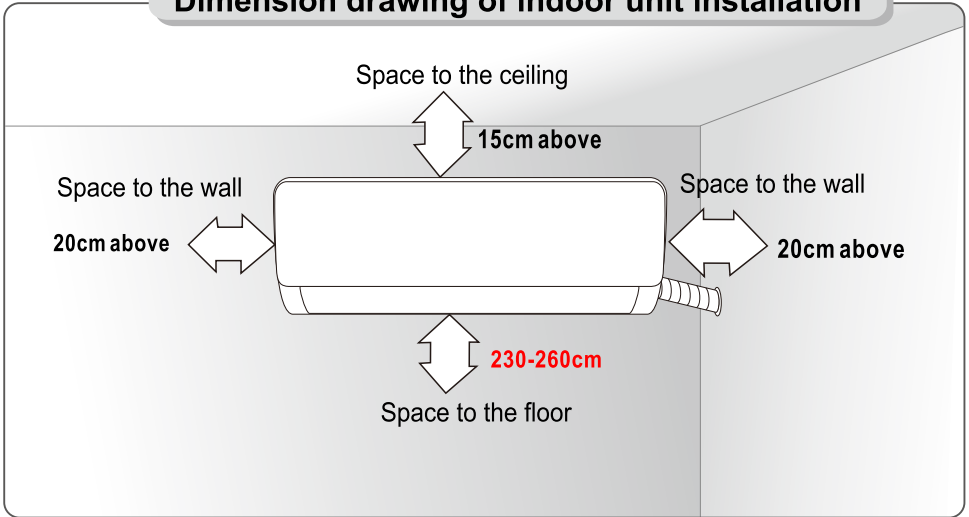

Mounting plate

1. The wall for installation of the indoor unit shall be hard and firm, so as to prevent vibration.
2. Use the "+" type screw to fasten the peg board, horizontally mount the peg board on the wall, and ensure the lateral horizontal and longitudinal vertical.
3. Pull the peg board by hand after the installation, to confirm whether it is solid.

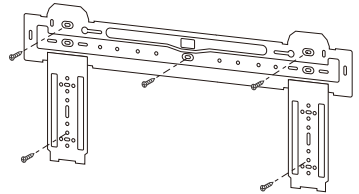

Wall-through Hole

1. Make a hole with an electric hammer or a water drill at the predetermined position on the wall for piping, which shall slant outwardly by 5°-10°.
2. To protect the piping and the cables from being damaged running through the wall, and from the rodents that may inhabit in the hollow wall, a pipe protecting ring shall be installed and sealed with putty.

Note: Usually, the wall hole is $\Phi 60\text{mm} \sim \Phi 80\text{mm}$.
Avoid pre-buried power wire and hard wall when making the hole.

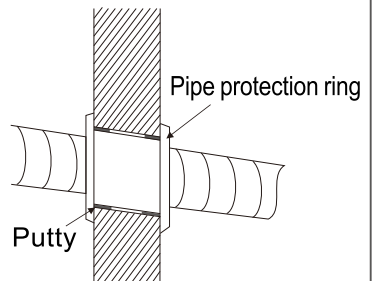

Install indoor unit

Route of Pipeline

1. Depending on the position of the unit, the piping may be routed sideway from the left or the right (Fig 1), or vertically from the back(Fig 2)(depending on the pipe length of the indoor unit). In the case of sideway routing, cut off the outlet cutting stock of the opposite side.

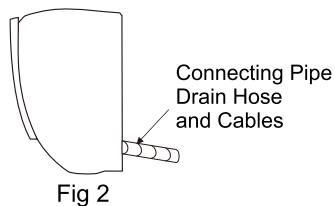
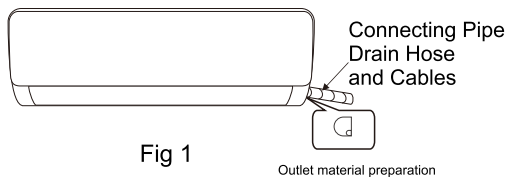

Drain pipe connection

1. Remove the fixed part to pull out pipe of indoor machine from the case. Screw the hexagon nut in the left of the joint to the end with your hand.
2. Connect the connecting pipe to the indoor unit:
Aim at the pipe center, tighten the Taper nut with fingers, and then tighten the Taper nut with a torque wrench, and the direction is shown in diagram on the right. The torque used is shown in the following table.

**Note: Carefully check if there is any damage of joints before installation.
The joints shall not be reused, unless after re-flaring the pipe.**

Tightening torque table

The size of pipe(mm)	Torque(N · m)
Φ6/Φ6.35	15~25
Φ9/Φ9.52	35~40
Φ12/Φ12.7	45~60
Φ15.88	73~78
Φ19.05	75~80

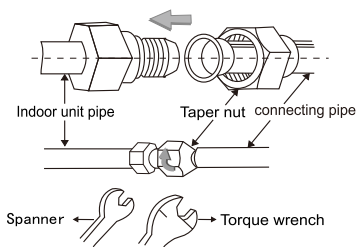

Wrap the Piping

1. Use the insulation sleeve to wrap the joint part the indoor unit and the connection pipe, and then use insulating material to pack and seal insulation pipe, to prevent generation of condensate water on the joint part.
2. Connect the water outlet with drain pipes, and make the connection pipe, cables, and the drain hose straight.
3. Use plastic cable ties to wrap the connecting pipes, cables and drain hose. Run the pipe sloping downward.

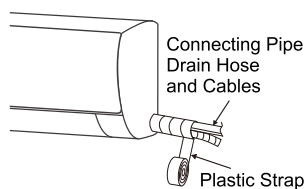

Install Indoor Unit

Fixing the Indoor Unit

1. Hang the indoor unit on the peg board, and move the unit from left to right to ensure that the hook is properly positioned in the peg board.
2. Push toward the lower left side and the upper right side of the unit toward the peg board, until the hook is embedded in the slot and makes a "click" sound.

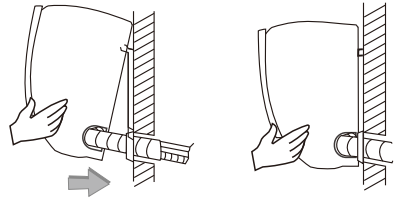

Wiring diagram

- If your air conditioner is provided with interconnection cord, the wiring of the indoor unit is connected in the factory, there is no need of connection.
- If the interconnection cord is not provided, connection is needed in accordance with the

After installation, check:

- 1.the screws whether have been fixed effectively, and there is no risk of loosening.
- 2.Connector of display board whether put in the right place and do not touch the terminal board.
- 3.Control box cover whether cover tightly.

constant speed

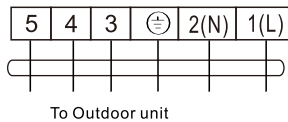
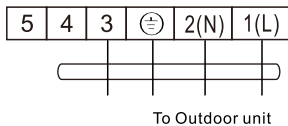

Variable speed

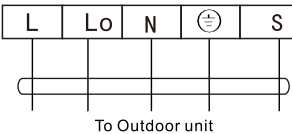
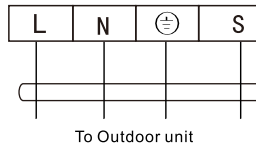

Connector



If there is a connector, connect it directly.

NOTE:

- ※ This manual usually includes the wiring mode for the different kind of A/C. We cannot exclude the possibility that some special type of wiring diagrams are not included.
- ※ The diagram are for reference only. If the entity is difference with this wiring diagram, please refer to the detailed wiring diagram adhered on the unit which you purchased.

Install indoor unit

Dimension drawing of outdoor unit installation

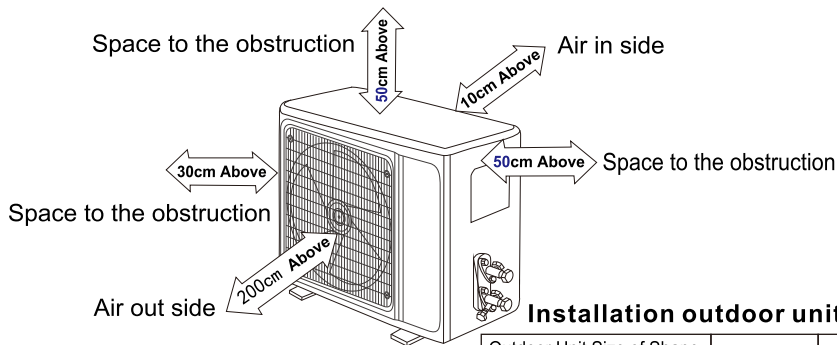

Installation outdoor unit bolt

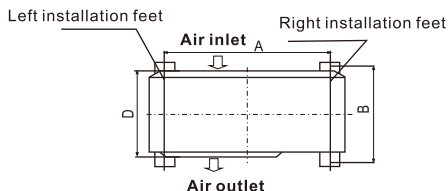
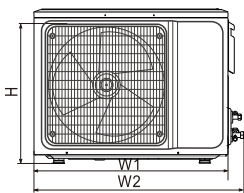

Outdoor Unit Size of Shape W1(W2)*H*D (mm)	A (mm)	B (mm)
665(710)×420×280	430	280
600(645)×485×260	400	290
660(710)×500×240	500	260
700(745)×500×255	460	260
730(780)×545×285	540	280
760(810)×545×285	540	280
790(840)×550×290	545	300
800(860)×545×315	545	315
800(850)×590(690)×310	540	325
825(880)×655×310	540	335
900(950)×700×350	630	350
900(950)×795×330	535	350
970(1044)×803×395	675	409

Install the connection pipe

Connect the Outdoor Unit with Connecting Pipe:

Aim the counter-bore of the connecting pipe at the stop valve, and tighten the Taper nut with fingers.

Then tighten the Taper nut with a torque wrench.

★When prolonging the piping, extra amount of refrigerant must be added so that the operation and performance of the air conditioner will not be compromised.

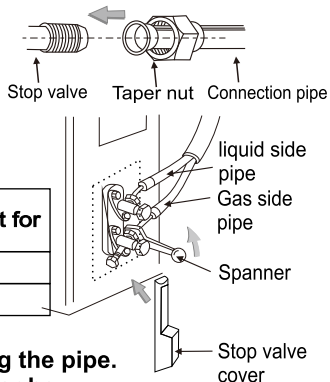

Piping length	Amount of refrigerant to be added		Amount of refrigerant for the unit
≤5M	Not needed		
5-15M	CC≤12000Btu	16g/m	≤1kg
	CC≥18000Btu	24g/m	≤2kg

Note: 1. This table is for reference only.

2. The joints shall not be reused, unless after re-flaring the pipe.

3. After installation, check the stop valve cover whether be fixed effectively.

Install outdoor Unit

Wiring Connection

1. Loosen the screws and remove E-parts cover from the unit.
2. Connect the cables respectively to the corresponding terminals of the terminal board of the outdoor unit (see the wiring diagram), and if there are signals connected to the plug, just conduct butt joint.
3. Ground wire: Remove the grounding screw out of the electric bracket, cover the grounding wire end onto the grounding screw and screw it into the grounding hole.
4. Fix the cable reliably with fasteners (Pressing board).
5. Put the E-parts cover back in its original place and fasten it with screws.

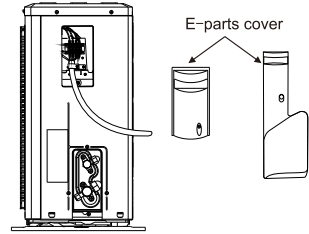

Wiring diagram

constant speed

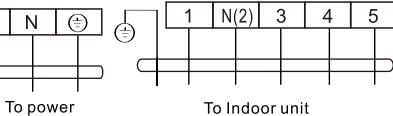
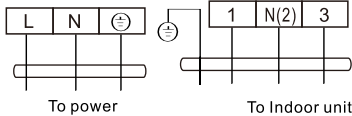

Variable speed

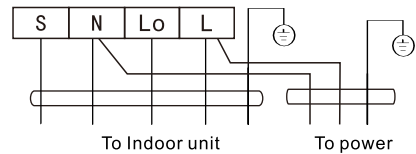
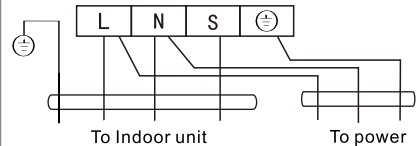

Connector



If there is a connector, connect it directly.

NOTE:

- ※ This manual usually includes the wiring mode for the different kind of A/C. We cannot exclude the possibility that some special type of wiring diagrams are not included.
- ※ The diagram are for reference only. If the entity is difference with this wiring diagram, please refer to the detailed wiring diagram adhered on the unit which you purchased.

Install outdoor unit

Vacuumping

★Exclusive R32 refrigerant pump must be used in making R32 refrigerant vacuum.

Before working on the air conditioner, remove the cover of the stop valve(gas and liquid valves)and be sure to retighten it afterward.(to prevent the potential air leakage)

1. To prevent air leakage and spilling tighten all connecting nut of all flare tubes.
2. Connect the stop valve, charge hose, manifold valve, and vacuum pump.
3. Fully open the handle Lo of the manifold valve and apply vacuum for at least 15 minutes and check that the compound vacuum gauge reads -0.1MPa(-76cmHg).
4. After applying vacuum, fully open the stop valve with a hex wrench.
5. Check that both indoor and outdoor connections are free of air leakage.

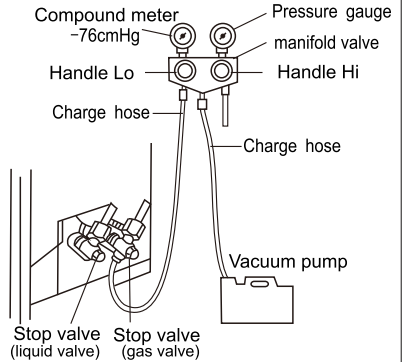

Outdoor condensation drainage(Heat pump type only)

When the unit is heating, the condensing water and defrosting water can be out reliably through the drain house.

Installation:

Install the outdoor drain elbow in $\Phi 25$ hole on the base plate, and joint the drain hose to the elbow, so that the waste water formed in the outdoor unit can be drained out to a proper plate.

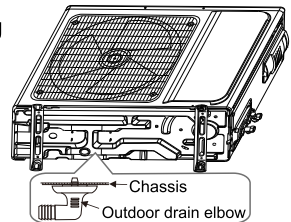

Check after installation and test operation

Check after installation

★ Electrical Safety Check

1. If the supply voltage is as required.
2. If there is any faulty or miss connection in each of the power, signal and grounding wires.
3. If the grounding wire of the air conditioner is securely grounded.

★ Installation Safety Check

1. If the installation is secure.
2. If the water drain is smooth.
3. If the wiring and piping are correctly installed.
4. Check that no foreign matter or tools are left inside the unit.
5. Check the refrigerant pipeline is protected well.

★ Leak test of the refrigerant

Depending on the installation method, the following methods may be used to check for suspect leak, on areas such as the four connections of the outdoor unit and the cores of the cut-off valves and t-valves:

1. Bubble method: Apply of spray a uniform layer of soap water over the suspected leak spot and observe carefully for bubble.
2. Instrument method: Checking for leak by pointing the probe of the leak detector according to the instruction to the suspect points of leak.

Note: Make sure that the ventilation is good before checking.

Test Operation

Test Operation preparation:

- ※Verify that all piping and connection cables are well connected.
- ※Confirm that the valves at the gas side the liquid-side are fully open.
- ※Connect the power cord to an independent power socket.
- ※Install batteries in remote control.

Note: Make sure that the ventilation is good before testing.

Test Operation method:

1. Turn on the power and push the ON/OFF switch button of the remote controller to start the air conditioner.
2. Select COOL, HEAT (not available on cool-only models), SWING and other operation modes with the remote controller and see if the operation is ok.

Maintenance Notice

Attention:

For maintenance or scrap, please contact authorized service centers.

Maintenance by unqualified person may cause dangers.

Feed air conditioner with R32 refrigerant, and maintain the air conditioner in strictly accordance with manufacturer's requirements. The chapter is mainly focused on special maintenance requirements for appliance with R32 refrigerant. Ask repairer to read after-sales technical service handbook for detailed information.

Qualification requirements of maintenance personnel

1. Special training additional to usual refrigerating equipment repair procedures is required when equipment with flammable refrigerants is affected. In many countries, this training is carried out by national training organisations that are accredited to teach the relevant national competency standards that may be set in legislation. The achieved competence should be documented by a certificate.
2. The maintenance and repair of the air conditioner must be conducted according to the method recommended by the manufacturer. If other professionals are needed to help maintain and repair the equipment, it should be conducted under the supervision of individuals who have the qualification to repair AC equipped with flammable refrigerant.

Inspection of the Site

Safety inspection must be taken before maintaining equipment with R32 refrigerant to make sure the risk of fire is minimized. Check whether the place is well ventilated, whether anti-static and fire prevention equipment is perfect.

While maintaining the refrigeration system, observe the following precautions before operating the system.

Operating Procedures

1. General work area:

All maintenance staff and others working in the local area shall be instructed on the nature of work being carried out. Work in confined spaces shall be avoided. The area around the workspace shall be sectioned off. Ensure that the conditions within the area have been made safe by control of flammable material.

2. Checking for presence of refrigerant:

The area shall be checked with an appropriate refrigerant detector prior to and during work, to ensure the technician is aware of potentially toxic or flammable atmospheres. Ensure that the leak detection equipment being used is suitable for use with all applicable refrigerants, i.e. non-sparking, adequately sealed or intrinsically safe.

3. Presence of fire extinguisher:

If any hot work is to be conducted on the refrigeration equipment or any associated parts, appropriate fire extinguishing equipment shall be available to hand. Have a dry powder or CO₂ fire extinguisher adjacent to the charging area.

Maintenance Notice

4.No ignition sources:

No person carrying out work in relation to a refrigeration system which involves exposing any pipe work shall use any sources of ignition in such a manner that it may lead to the risk of fire or explosion. All possible ignition sources, including cigarette smoking, should be kept sufficiently far away from the site of installation, repairing, removing and disposal, during which refrigerant can possibly be released to the surrounding space. Prior to work taking place, the area around the equipment is to be surveyed to make sure that there are no flammable hazards or ignition risks.

'No Smoking' signs shall be displayed.

5.Ventilated Area(open the door and window):

Ensure that the area is in the open or that it is adequately ventilated before breaking into the system or conducting any hot work. A degree of ventilation shall continue during the period that the work is carried out. The ventilation should safely disperse any released refrigerant and preferably expel it externally into the atmosphere.

6.Checks to the refrigeration equipment:

Where electrical components are being changed, they shall be fit for the purpose and to the correct specification. At all times the manufacturer's maintenance and service guidelines shall be followed. If in doubt, consult the manufacturer's technical department for assistance. The following checks shall be applied to installations using flammable refrigerants:

- The charge size is in accordance with the room size within which the refrigerant containing parts are installed.
- The ventilation machinery and outlets are operating adequately and are not obstructed.
- If an indirect refrigerating circuit is being used, the secondary circuit shall be checked for the presence of refrigerant.
- Refrigeration pipe or components are installed in a position where they are unlikely to be exposed to any substance which may corrode refrigerant containing components, unless the components are constructed of materials which are inherently resistant to being corroded or are suitably protected against being so corroded.

7.Checks to electrical devices:

Repair and maintenance to electrical components shall include initial safety checks and component inspection procedures. If a fault exists that could compromise safety, then no electrical supply shall be connected to the circuit until it is satisfactorily dealt with. If the fault cannot be corrected immediately but it is necessary to continue operation, an adequate temporary solution shall be used. This shall be reported to the owner of the equipment so all parties are advised.

Initial safety checks shall include:

- That capacitors are discharged: this shall be done in a safe manner to avoid possibility of sparking.
- That no live electrical components and wiring are exposed while charging, recovering or purging the system.
- Keep continuity of earthing.

Inspection of Cable

Check the cable for wear, corrosion, overvoltage, vibration and check if there are sharp edges and other adverse effects in the surrounding environment. During the inspection, the impact of aging or the continuous vibration of the compressor and the fan on it should be taken into consideration.

Leakage check of R32 refrigerant

Note: Check the leakage of the refrigerant in an environment where there is no potential ignition source. No halogen probe (or any other detector that uses an open flame) should be used.

Leak detection method:

For systems with refrigerant R32, electronic leak detection instrument is available to detect and leak detection should not be conducted in environment with refrigerant. Make sure the leak detector will not become a potential source of ignition, and is applicable to the measured refrigerant. Leak detector shall be set for the minimum ignitable fuel concentration (percentage) of the refrigerant. Calibrate and adjust to proper gas concentration (no more than 25%) with the used refrigerant.

The fluid used in leak detection is applicable to most refrigerants. But do not use chloride solvents to prevent the reaction between chlorine and refrigerants and the corrosion of copper pipeline.

If you suspect a leak, then remove all the fire from the scene or put out the fire.

If the location of the leak needs to be welded, then all refrigerants need to be recovered, or, isolate all refrigerants away from the leak site (using cut-off valve). Before and during the welding, use OFN to purify the entire system.

Removal and Vacuum Pumping

1. Make sure there is no ignited fire source near the outlet of the vacuum pump and the ventilation is well.
2. Allow the maintenance and other operations of the refrigeration circuit should be carried out according to the general procedure, but the following best operations that the flammability is already taken into consideration are the key. You should follow the following procedures:
 - Remove the refrigerant.
 - Decontaminate the pipeline by inert gases.
 - Evacuation.
 - Decontaminate the pipeline by inert gases again.
 - Cut or weld the pipeline.
3. The refrigerant should be returned to the appropriate storage tank. The system should be blown with oxygen free nitrogen to ensure safety. This process may need to be repeated for several times. This operation shall not be carried out using compressed air or oxygen.

Maintenance Notice

3. Through blowing process, the system is charged into the anaerobic nitrogen to reach the working pressure under the vacuum state, then the oxygen free nitrogen is emitted to the atmosphere, and in the end, vacuumize the system. Repeat this process until all refrigerants in the system is cleared. After the final charging of the anaerobic nitrogen, discharge the gas into the atmosphere pressure, and then the system can be welded. This operation is necessary for welding the pipeline.

Procedures of Charging Refrigerants

As a supplement to the general procedure, the following requirements need to be added:

- Make sure that there is no contamination among different refrigerants when using a refrigerant charging device. The pipeline for charging refrigerants should be as short as possible to reduce the residual of refrigerants in it.
- Storage tanks should remain vertically up.
- Make sure the grounding solutions are already taken before the refrigeration system is charged with refrigerants.
- After finishing the charging (or when it is not yet finished), label the mark on the system.
- Be careful not to overcharge refrigerants.

Scrap and Recovery

Scrap:

Before this procedure, the technical personnel shall be thoroughly familiar with the equipment and all its features, and make a recommended practice for refrigerant safe recovery. For recycling the refrigerant, shall analyze the refrigerant and oil samples before operation. Ensure the required power before the test.

1. Be familiar with the equipment and operation.
2. Disconnect power supply.
3. Before carrying out this process, you have to make sure:
 - If necessary, mechanical equipment operation should facilitate the operation of the refrigerant tank.
 - All personal protective equipment is effective and can be used correctly.
 - The whole recovery process should be carried out under the guidance of qualified personnel.
 - The recovering of equipment and storage tank should comply with the relevant national standards.
4. If possible, the refrigerating system should be vacuumized.
5. If the vacuum state can't be reached, you should extract the refrigerant in each part of the system from many places.
6. Before the start of the recovery, you should ensure that the capacity of the storage tank is sufficient.
7. Start and operate the recovery equipment according to the manufacturer's instructions.

Maintenance Notice

8. Don't fill the tank to its full capacity (the liquid injection volume does not exceed 80% of the tank volume).
9. Even the duration is short, it must not exceed the maximum working pressure of the tank.
10. After the completion of the tank filling and the end of the operation process, you should make sure that the tanks and equipment should be removed quickly and all closing valves in the equipment are closed.
11. The recovered refrigerants are not allowed to be injected into another system before being purified and tested.

Note: The identification should be made after the appliance is scrapped and refrigerants are evacuated. The identification should contain the date and endorsement. Make sure the identification on the appliance can reflect the flammable refrigerants contained in this appliance.

Recovery:

1. The clearance of refrigerants in the system is required when repairing or scrapping the appliance. It is recommended to completely remove the refrigerant.
2. Only a special refrigerant tank can be used when loading the refrigerant into the storage tank. Make sure the capacity of the tank is appropriate to the refrigerant injection quantity in the entire system. All tanks intended to be used for the recovery of refrigerants should have a refrigerant identification (i.e. refrigerant recovery tank). Storage tanks should be equipped with pressure relief valves and globe valves and they should be in a good condition. If possible, empty tanks should be evacuated and maintained at room temperature before use.
3. The recovery equipment should be kept in a good working condition and equipped with equipment operating instructions for easy access. The equipment should be suitable for the recovery of R32 refrigerants. Besides, there should be a qualified weighting apparatus which can be normally used. The hose should be linked with detachable connection joint of zero leakage rate and be kept in a good condition.
Before using the recovery equipment, check if it is in a good condition and if it gets perfect maintenance. Check if all electrical components are sealed to prevent the leakage of the refrigerant and the fire caused by it. If you have any question, please consult the manufacturer.
4. The recovered refrigerant shall be loaded in the appropriate storage tanks, attached with a transporting instruction, and returned to the refrigerant manufacturer. Don't mix refrigerant in recovery equipment, especially a storage tank.
5. The space loading R32 refrigeration can't be enclosed in the process of transportation. Take anti electrostatic measures if necessary in transportation. In the process of transport, loading and unloading, necessary protective measures must be taken to protect the air conditioner to ensure that the air conditioner is not damaged.
6. When removing the compressor or clearing the compressor oil, make sure the compressor is pumped to an appropriate level to ensure that there is no residual R32 refrigerants in the lubricating oil. The vacuum pumping should be carried out before the compressor is returned to the supplier. Ensure the safety when discharging oil from the system.

Korisničko uputstvo

Zidni split sistem klima uređaj

Za model

IVA1-12IR

IVA1-18IR

IVA1-24IR

IVA5-12JR

IVA5-18JR

IVA5-24JR

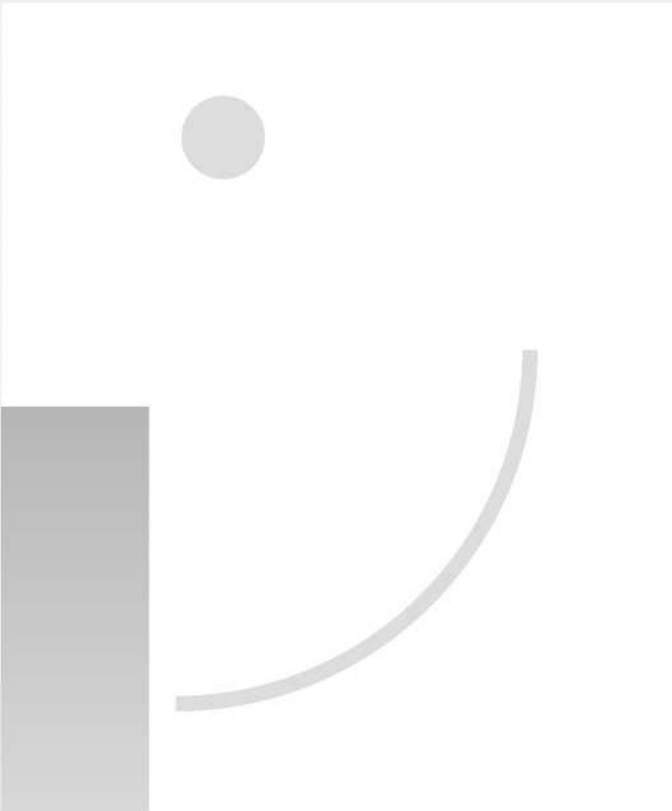
- 
- ※ Molimo da pre rukovanja uređajem pažljivo i detaljno pročitate ovo uputstvo!
 - ※ Sačuvajte ovo uputstvo za kasniju upotrebu.

Upotreba i održavanje

Upozorenje	1
Bezbednosne informacije	2
Napomene za upotrebu	7
Nazivi delova uređaja	9
Čišćenje i održavanje	10
Rešavanje problema	12

Postavljanje i servisiranje





Napomene za postavljanje	14
Postavljanje unutrašnje jedinice	18
Postavljanje spoljne jedinice	21
Provera nakon postavljanja i test funkcionisanja	24
Održavanje.....	25

Napomena: Sve slike u ovom uputstvu su samo šematski prikazi, stvarni izgled uređaja može se razlikovati.

Upozorenje: Ovaj klima uređaj koristi R 32 zapaljivo rashladno sredstvo.

Napomene: Ukoliko se klima uređaj sa R32 rashladnim sredstvom loše tretira, može izazvati ozbiljna oštećenja po ljude i okolinu.

- * Prostor za ugradnju, upotrebu, popravku i skladištenje ovog klima uređaja treba biti veći od 5m!
- * Klima uređaj ne smete puniti sa više od 1,7kg rashladnog sredstva.
- * Ne koristite ubrzane metode za odleđivanje ili čišćenje zaleđenih delova, osim ukoliko tako ne preporučuje proizvođač.
- * Nemojte bušiti ili paliti klima uređaj i proverite da li je oštećena pumpa za rashladno sredstvo.
- * Klima uređaj treba da se nalazi u prostoriji bez trajnog izvora vatre, kao što su otvoreni plamen, gasni uređaji, električna grejna tela i slično.
- * Imajte u vidu da je rashladno sredstvo bez ukusa.
- * Klima uređaj treba da se nalazi na mestu gde nisu moguća slučajna mehanička oštećenja.
- * Održavanje i popravka klima uređaja koji koristi R32 rashladno sredstvo moraju se izvoditi tek nakon obavljenih sigurnosnih provera radi smanjenja rizika od nesreće.
- * Klima uređaj mora biti instaliran sa poklopljenim zaustavnim ventilom.
- * Pažljivo pročitajte uputstvo pre ugradnje, upotrebe i održavanja.

Simbol	Napomena	Objašnjenje
	UPOZORENJE	Simbol pokazuje da uređaj koristi zapaljivo rashladno sredstvo. Ako sredstvo curi i izloženo je eksternom izvoru paljenja, postoji rizik od požara.
	OPREZ	Simbol pokazuje da treba pažljivo pročitati uputstvo za upotrebu.
	OPREZ	Simbol pokazuje da servisno osoblje treba da upravlja opremom, pridržavajući se uputstva.
	OPREZ	Simbol pokazuje da su informacije poput uputstva za upotrebu ili instalaciju dostupne.

Bezbednosne informacije

Nepravilno postavljanje ili upotreba usled nepoštovanja datih uputstava može da izazove povrede ili štetu osobama, imovini, itd.

Stepen ozbiljnosti klasifikovan je na sledeći način:

UPOZORENJE

Ovaj simbol označava mogućnost smrtnog ishoda ili ozbiljne povrede.

OPREZ

Ovaj simbol označava mogućnost povrede ili oštećenja imovine.

UPOZORENJE

Ovim uređajem mogu upravljati deca iznad 8 godina i osobe sa smanjenim fizičkim, senzornim ili mentalnim sposobnostima, ili sa nedostatkom iskustva i znanja ukoliko su pod nadzorom ili su im data uputstva za rukovanje uređajem na bezbedan način i ukoliko razumeju opasnost do koje može doći. Deca se ne smeju igrati sa uređajem. Čišćenje i održavanje uređaja ne treba poveriti deci bez nadzora.

(Samo za klima uređaje sa oznakom CE)

Ovaj uređaj nije namenjen za upotrebu od strane osoba (uključujući decu) sa smanjenim fizičkim, senzornim ili mentalnim sposobnostima, ili nedostatkom iskustva i znanja, osim ukoliko su pod nadzorom ili su im data uputstva od osobe odgovorne za njihovu bezbednost. Decu treba nadzirati kako biste se uverili da se ne igraju s uređajem.

(Osim kod klima uređaja sa oznakom CE)

Klima uređaj mora biti uzemljen. Nepotpuno uzemljenje uređaja može dovesti do strujnog udara.



Ne povezujte uzemljenje na uzemljenje gasovoda, vodovoda, gromobrana ili telefona.

Izvcite utikač (ili isključite osigurač) ukoliko uređaj nećete koristiti duže vreme kako biste osigurali bezbednost.



Vodite računa da se daljinski i unutrašnja jedinica ne nakvase previše niti da budu dugo vlažni.

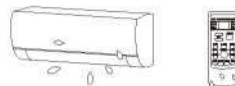

NO!

U suprotnom, može doći do kratkog spoja.

Ukoliko je napojni kabl oštećen, mora biti zamenjen od strane proizvođača ili ovlašćenog servisera ili kvalifikovanog lica.



Ne izvlačite utikač tokom rada uređaja mokrim rukama.



To može prouzrokovati strujni udar.

Nemojte deliti utičnicu sa drugim električnim uređajima.

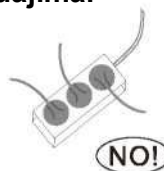

U suprotnom, može doći do strujnog udara, pa čak i požara i eksplozije.

Pre čišćenja i održavanja uređaja uvek isključite uređaj i napajanje.



U suprotnom, može doći do strujnog udara ili oštećenja.

Ne vucite kabl prilikom isključivanja iz utičnice.



Šteta nastala povlačenjem kabla može prouzrokovati strujni udar.

Cevi priključene na uređaj nemaju izvor paljenja.

Bezbednosne informacije

Nemojte postavljati uređaj na mestu blizu zapaljivog gasa ili tečnosti. Rastojanje među njima mora biti više od 1m.

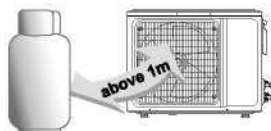

To može dovesti do požara, pa čak i eksplozije.

Nemojte koristiti tečnost ili korozivno sredstvo za čišćenje klima uređaja niti posipati vodom ili drugom tečnošću.

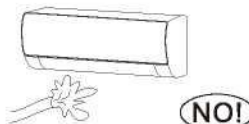

Ovo može dovesti do strujnog udara ili oštećenja uređaja.

Nemojte pokušavati da sami popravljate klima uređaj.

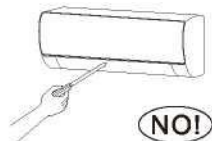

Nepravilna popravka može uzrokovati požar ili kesploziju. Kontaktirajte ovlašćenog servisera za sve vrste popravki.

Nemojte koristiti klima uređaj po olujnom vremenu.

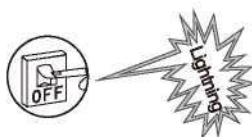

Prekidač treba da bude isključen kako bi se sprečila pojava oštećenja.

Ne stavljajte ruke ili bilo koji drugi predmet u odvodna i dovodna creva.

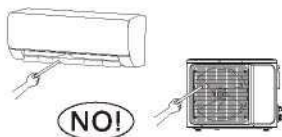

Ovo može dovesti do povrede osobe ili oštećenja uređaja.

Molimo proverite da li je montirano postolje za spoljnu jedinicu dovoljno čvrsto ili ne.

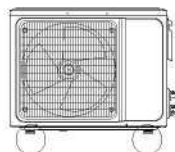

Ukoliko je oštećeno, može dovesti do pada jedinice i uzrokovati povredu.

Nemojte stavljati prepreke u blizini dovoda i odvoda vazduha.

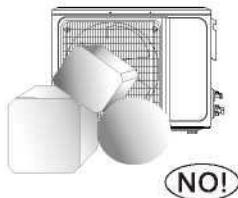

U suprotnom, kapacitet hlađenja ili grejanja će oslabiti, čak može dovesti i do prestanka rada uređaja.

Nemojte dozvoliti da klima uređaj duva u pravcu grejnog tela.



U suprotnom, to može dovesti do nepotpunog sagorevanja, uzrokujući moguće trovanje.

Uređaj mora biti instaliran u skladu sa zakonskim propisima za povezivanje strujnog kola.

Osigurač za potrošnju struje mora biti postavljen kako bi se sprečio mogući strujni udar.

Ovaj proizvod sadrži fluorovane gasove s efektom staklene bašte.

Curenje rashladnog sredstva doprinosi klimatskim promenama. Rashladno sredstvo sa nižim stepenom grejne snage (GWP) manje doprinosi globalnom zagrevanju nego sredstvo sa višim stepenom grejne snage, ukoliko se otpusti u atmosferu.

Ovaj uređaj sadrži rashladno sredstvo sa snagom GPW [675].

To znači da ako 1 kg ovog rashladnog sredstva treba da se otpusti u atmosferu, uticaj na globalno zagrevanje će biti [675] puta veći od oslobađanja 1 kg CO₂, za period od 100 godina.

Nikada ne pokušavajte da sami dirate rashladno kolo ili rastavljate uređaj i uvek tražite pomoć kvalifikovanog servisera.

Vodite računa da ispod unutrašnje jedinice ne budu sl. predmeti:

1. Mikrotalasna, rerna i drugi vrući predmeti.
2. Računari i drugi visoko elektrostatički uređaji.
3. Utičnice koje često koristite.

Spojne cevi između unutrašnje i spoljne jedinice se ne pomeraju, osim ako ne puknu.

Specifikacije osigurača su odštampane na ploči, kao 3.15A/250V AC, itd.

Upozorenje WEEE

Značenje precrtanog kontejnera za smeće:
Ne odlažite električne uređaje kao nesortirani otpad, koristite odvojene prostorije za sakupljanje.

Kontaktirajte Vašu lokalnu upravu kako biste dobili informacije u vezi sa raspoloživim sistemima za sakupljanje otpada.

Ukoliko se električni otpad odloži na deponiju ili smetlišta, opasne materije mogu da procure u podzemne vode, uđu u lanac ishrane, škodeći zdravlju i blagostanju.

Prilikom zamene starih uređaja novim, prodavac je zakonski obavezan da preuzme stari uređaj i odloži ga bez novčane naknade.



Bezbednosne informacije

OPREZ

Nemojte dugo držati otvorene prozore i vrata dok je klima uređaj uključen.



U suprotnom kapacitet hlađenja ili grejanja će biti oslabljen.

Nemojte stajati na spoljnoj jedinici niti stavljati teške stvari na nju.

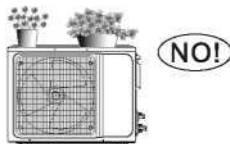

Ovo može prouzrokovati povredu osobe ili dovesti do oštećenja uređaja.

Nemojte koristiti klima uređaj za druge svrhe, kao što je sušenje veša, čuvanje hrane itd.



Nemojte izlagati telo hladnom vazduhu na duži period.

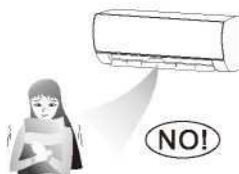

To će pogoršati fizičke uslove i uzrokovati zdravstvene probleme.

Podesite odgovarajuću temperaturu.

Preporučuje se da razlika između unutrašnje i spoljašnje temperature ne bude prevelika.



Odgovarajuće korekcije podešavanja temperature mogu sprečiti rasipanje električne energije.

Ukoliko Vaš klima uređaj nije opremljen kablom i utikačem, jednopolni prekidač mora biti postavljen u fiksnu instalaciju i razdaljina između kontakata ne sme biti manja od 3.0 mm.

Ukoliko je Vaš uređaj trajno povezan na žičnu konstrukciju, (RCD) uređaj za diferencijaciju struje koji ne prelazi 30 mA treba da se postavi.

Strujno napojno kolo treba da ima zaštitnik za curenje i prekidač čiji kapacitet treba da bude 1.5 puta veći od maksimalne struje.

Što se tiče postavljanja klima uređaja, konsultujte odeljke ispod u ovom uputstvu.

Napomene za upotrebu

Uslovi u kojima jedinica ne može normalno da radi

- * Ukoliko nije u temperaturnom opsegu prikazanom u sledećoj tabeli, klima uređaj može prestati s radom i mogu se pojaviti druge nepravilnosti.

Hlađenje	Spoljna	>43°C (Primenjuje se za T1)
		>52°C (Primenjuje se za T3)
	Unutrašnja	<18°C
Grejanje	Spoljna	>24°C
		<-7°C
	Unutrašnja	>27°C

- * Kada je temperatura previsoka, može se aktivirati uređaj za automatsku zaštitu, tako da će se klima uređaj ugasiti.
- * Kada je temperatura preniska, uređaj za razmenu toplote klima uređaja se može zamrznuti, što može dovesti do curenja vode ili drugih nepravilnosti u radu.
- * U toku dugog hlađenja i isušivanja relativne vlažnosti preko 80% (vrata i prozori su otvoreni), može se javiti kondenzacija vode ili doći do kapanja vode blizu odvoda vazduha.
- * T1 i T3 odnose se na standard ISO 5151.

Napomene za grejanje

- * Ventilator unutrašnje jedinice neće odmah početi s radom nakon početka grejanja kako bi se izbeglo izduvanje hladnog vazduha.
- * Kada je napolju hladno i vlažno, kod spoljne jedinice može doći do stvaranja mraza iznad uređaja za razmenu toplote što će ugroziti kapacitet grejanja. Kada klima uređaj započne sa radom, doći će do otapanja.
- * Tokom otapanja, klima uređaj će prestati s grejanjem u periodu od oko 5-12 minuta.
- * Tokom otapanja moguće je isparavanje iz spoljne jedinice. Ovo nije nepravilnost, već rezultat brzog otapanja.
- * Grejanje će se nastaviti kada je otapanje u potpunosti gotovo.

Napomene za isključivanje

- * Kada je klima uređaj isključen, glavni kontroler će automatski odlučiti da li da odmah stane s radom ili će raditi još desetak sekundi sa smanjenom frekvencijom i brzinom izduvanja vazduha.

Napomene za upotrebu

Rad u vanrednim slučajevima

- * Ukoliko je daljinski upravljač izgubljen ili polomljen, koristite dugme za forsirani rad klima uređaja.
- * Ukoliko ovo dugme pritisnete kada je uređaj ugašen, klima uređaj će početi s radom u automatskom režimu rada.
- * Ukoliko ovo dugme pritisnete kada je uređaj uključen, klima uređaj će prestati sa radom.

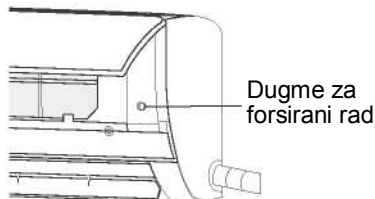

Podešavanje smera duvanja vazduha

1. Koristite tastere krilca gore-dole i levo-desno na daljinskom upravljaču kako biste podesili smer duvanja vazduha. Za detalje pogledajte uputstvo o korišćenju daljinskog upravljača.
2. Za modele bez mogućnosti duvanja krilaca levo-desno, rebra treba da se pomeraju ručno.

Napomena: Pomerajte krilca pre nego što uređaj počne s radom, jer može doći do povrede Vaših prstiju. Nikada nemojte stavljati ruke u dovod ili odvod vazduha u toku rada klima uređaja.

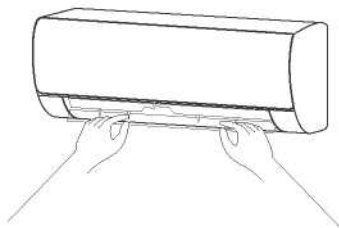

Poseban oprez

1. Otvorite prednji poklopac unutrašnje jedinice.
2. Konektor ne dodiruje priključnu ploču i pozicioniran je kao na slici.

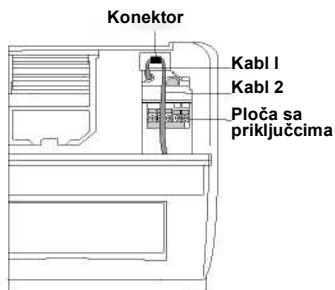

Nazivi delova klima uređaja

Unutrašnja jedinica

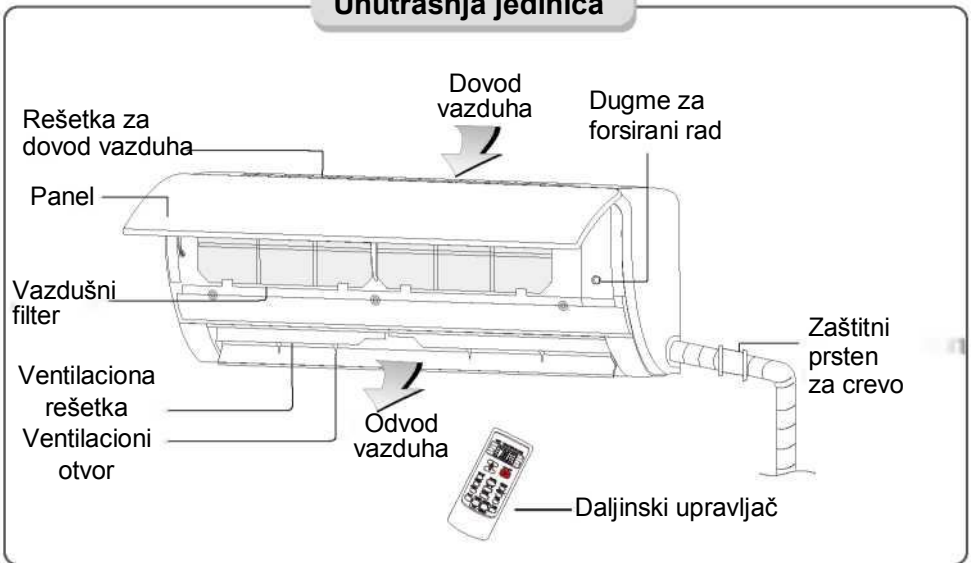

Spoljna jedinica

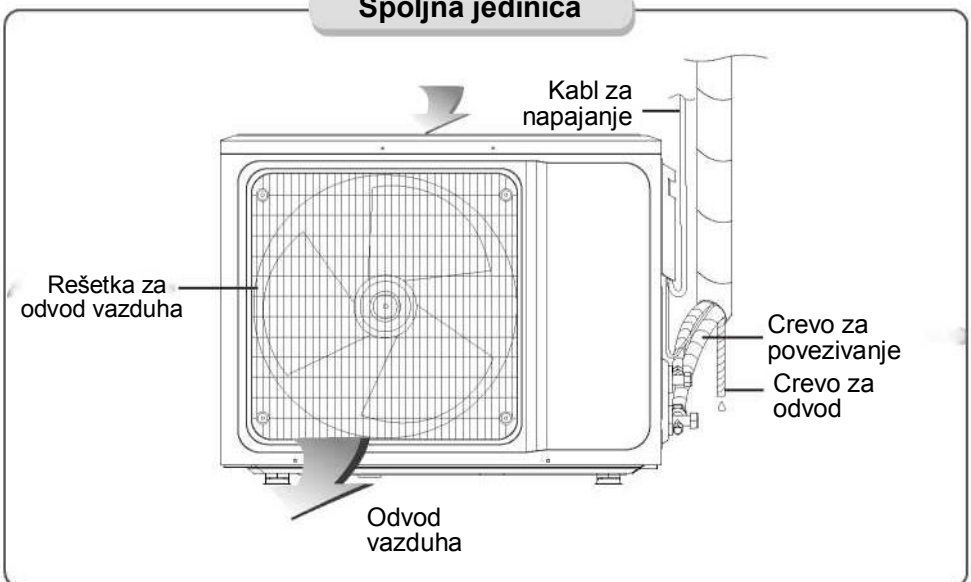

Napomena: Na svim slikama u ovom uputstvu dat je samo šematski prikaz. Stvarni izgled uređaja može se razlikovati.

Utikač, Wi Fi funkcija, Funkcija negativnih jona, Funkcije vertikalnog i horizontalnog pomeranja su opcione, zavisno od konkretne jedinice.

Čišćenje i održavanje

⚠ Upozorenje

- Pre čišćenja, klima uređaja mora biti ugašen i isključen iz zida više od 5 minuta, u suprotnom postoji rizik od strujnog udara.
- Nemojte kvasiti klima uređaj, jer to može prouzrokovati strujni udar. Postarajte se da ni u kom slučaju ne ispirate klima uređaj vodom.
- Isparljive tečnosti, kao što su na primer razređivač ili benzin, mogu oštetiti kućište klima uređaja, zato Vas molimo da kućište čistite isključivo mekom suvom krpom i vlažnom krpom natopljenom neutralnim deterdžentom.
- Tokom upotrebe, vodite računa o redovnom čišćenju filtera, kako biste sprečili gomilanje prašine koja može smanjiti efekte rada uređaja. Ukoliko je u okruženju uređaja dosta prašine, to će povećati broj neophodnih čišćenja uređaja. Nakon uklanjanja filtera, ne dodirujte fini deo unutrašnje jedinice prstom, jer ga možete izgrebati.

Čišćenje panela

Kada je panel (poklopac) unutrašnje jedinice zaprljan, očistite ga nežno mekom krpom koristeći toplu vodu ispod 40°C i nemojte pomerati panel tokom čišćenja.

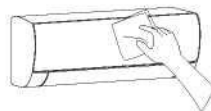

Čišćenje vazdušnog filtera

■ Uklonite vazdušni filter

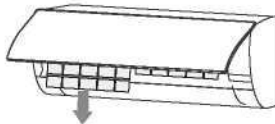
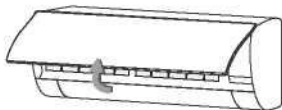

1. Koristite obe ruke da biste otvorili panel držeći u uglovima na oba kraja panela u smeru strelice.
2. Izvucite vazdušni filter iz ležišta i uklonite ga.

■ Čišćenje vazdušnog filtera

Upotrebite usisivač ili vodom isperite filter, a ukoliko je filter jako zaprljan (na primer masnoćom), čistite ga toplom vodom (ispod 45°C) sa rastvorenim blagim deterdžentom i ostavite filter da se u hladu osuši napolju.



■ Montirajte filter

1. Postavite osušeni filter u suprotnom smeru od uklanjanja, zatim poklopite i zaključajte ploču.

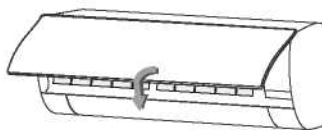
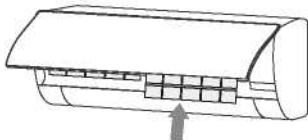

Proverite pre upotrebe

1. Proverite da li su otvori za dovod i odvod vazduha odblokirani na jedinicama.
2. Proverite da li dolazi do blokiranja vode u odvodnom crevu, i odmah očistite ukoliko ga ima.
3. Proverite da li je dobro uzemljenje.
4. Proverite da li su baterije postavljene u daljinskom upravljaču, i da li imaju dovoljno snage.
5. Proverite da nije došlo do oštećenja držača za montiranje spoljne jedinice i, ukoliko jeste, molimo pozovite ovlašćeni servis.

Održavanje nakon upotrebe

1. Isključite naponski kabl iz klima uređaja, isključite prekidač i izvadite baterije iz daljinskog upravljača.
2. Očistite filter i telo jedinica.
3. Uklonite prašinu i prljavštinu iz spoljne jedinice.
4. Proverite da nije došlo do oštećenja držača za montiranje spoljne jedinice i, ukoliko jeste, molimo pozovite ovlašćeni servis.

Rešavanje problema

Oprez

*Nemojte sami popravljati uređaj, jer loše održavanje može dovesti do strujnog udara ili požara. Molimo da kontaktirate ovlašćeni servisni centar i prepustite profesionalnom serviseru da vodi brigu o održavanju Vašeg klima uređaja, a provera sledećih stavki pre nego što pozovete održavanje može uštedeti Vaše vreme i novac.

Problem	Moguće rešenje
Klima uređaj ne radi.	<ul style="list-style-type: none">• Možda je došlo do prekida struje. → Sačekajte dok se napajanje ne vrati.• Možda se utikač izvukao iz utičnice. → Čvrsto stavite utikač u utičnicu.• Možda je došlo do ispada osigurača. → Zamenite osigurač.• Još nije došlo vreme podešenog tajmera. → Sačekajte ili poništite podešavanje tajmera.
Unutrašnja jedinica ne radi odmah nakon što je klima uređaj restartovan.	<ul style="list-style-type: none">• Ukoliko je klima uređaj uključen odmah nakon što je isključen, u cilju zaštite odložiće se početak rada za 3-5 minuta.
Klima uređaj prestaje sa radom, a nakon nekog vremena opet počinje.	<ul style="list-style-type: none">• Možda je dostignuta podešena temperatura. → To je normalna pojava.• Možda je u režimu odmrzavanja. → Nakon odmrzavanja počće automatski sa radom.• Podešen je tajmer isključivanja. → Uključite uređaj ponovo ukoliko želite da nastavi sa radom.
Dolazi do duvanja, ali efekat hlađenja/grejanja nije dobar.	<ul style="list-style-type: none">• Preterana akumulacija prašine na filter blokira ulaz i izlaz vazduha, ugao na rešetkama za ispuštanje vazduha je previše mali, što ima uticaj na efekat grejanja i hlađenja. → Očistite filter, uklonite prepreke za ulaz i izlaz vazduha i regulišite ugao na rešetkama za ispuštanje vazduha.• Slab efekat hlađenja i grejanja može biti usled otvaranja prozora i vrata i nezatvorenog izduvnog ventilatora. → Zatvorite vrata, prozore, izduvni ventilator i slično.• Funkcija pomoćnog grejanja nije uključena tokom. → Uključite funkciju pomoćnog grejanja. (samo sa modelom sa funkcijom pomoćnog grejanja)• Podešen je pogrešan reim rada i temperatura i brzina duvanja nisu odgovarajući. → Izaberite ponovo režim rada i podesite odgovarajuću temperaturu i brzinu duvanja.
Unutrašnja jedinica izduvava neprijatan miris.	<ul style="list-style-type: none">• Klima uređaj sam po sebi nema neprijatan miris. Ukoliko se on pojavi, moguća je akumulacija mirisa iz okruženja. → Očistite filter ili aktivirajte funkciju čišćenja.

Čuje se zvuk tekuće vode tokom rada klima uređaja.

- Kada se klima uređaj pokrene ili zaustavi, ili se kompresor se pokrene ili zaustavlja tokom rada, ponekad se čuje zvuk šištanja vode.
→ Ovo je zvuk protoka rashladnog sredstva i nije kvar.

Lagani "klik" zvuk se čuje prilikom paljenja ili gašenja uređaja.

- Usled temperaturnih promena, radna ploča i ostali delovi će dostići određenu temperaturu, uzrokujući zvuk trenja.
→ Ovo je normalno, nije problem.

Unutrašnja jedinica proizvodi čudan zvuk.

- Zvuk ventilatora ili kompresora pokazuje uključivanje ili isključivanje.
- Kada odmrzavanje počinje ili prestaje da radi, čuje se zvuk.
→ Uzrok je protok rashladnog sredstva u obrnutom pravcu. Ovo nisu kvarovi.
- Prevelika akumulacija prašine na vazдушnom filteru unutrašnje jedinice može dovesti do fluktuacije zvuka.
→ Očistite povremeno vazdušne filtere.
- Prevelika buka kada je uključen režim "Intenzivno izduvavanje". → Ovo je normalno, ukoliko vam je zvuk neprijatan isključite funkciju "Intenzivnog izduvavanja".

Kapi vode na površini unutrašnje jedinice.

- Kada je velika vlažnost vazduha dolazi do akumuliranja kapljica vode oko izlaza za vazduh, na poklopcu i slično.
→ Ovo je normalna pojava.
- Produženo hlađenje na otvorenom prostoru stvara kapi vode.
→ Zatvorite vrata i prozore.
- Previše mali ugao otvaranja lopatica takođe može rezultirati kapljicama vode na dovodu vazduha.
→ povećajte ugao na rešetkama za ispuštanje vazduha.

Ponekad tokom hlađenja unutrašnja jedinica izduvava maglu.

- To se dešava ponekad kada su unutrašnja temperatura i vlažnost vazduha visoki.
→ Razlog je brzo hlađenje unutrašnjeg vazduha. Nakon što klima uređaj radi neko vreme, temperatura i vlažnost se smanjuju i magla nestaje.



Odmah zaustavite sve operacije i isključite dovod struje i pozovite ovlašćeni servisni centar u sledećim situacijama.

- ▲ Čuje se prodoran zvuk ili se emituje neprijatan miris tokom rada uređaja.
- ▲ Napojni kabl i utikač su izuzetno topli.
- ▲ Slučajno je uređaj ili daljinski upravljač napunjen nečistoćom ili vodom.
- ▲ Prekidač za vazduh ili zaštitni prekidač se često lomi.

Napomene za postavljanje

❗ Važne napomene

- Pre ugradnje, molimo kontaktirajte lokalni ovlašćeni centar za održavanje. Ako jedinicu ne instalira ovlašćeni centar za održavanje, neispravnosti možda neće biti rešene.
- Uredjaj mora da bude instaliran od strane ovlašćenog servisa, u skladu sa državnim propisima i ovim uputstvom.
- Nakon ugradnje mora se ispitati curenje rashladnog sredstva.
- Ukoliko želite da promenite mesto ugradnje uređaja, pozovite ovlašćeni servis.

Provera raspakovanja

- Otvorite kutiju i proverite klima uređaj na mestu sa dobrom ventilacijom (otvorite vrata i prozor) i bez izvora paljenja. Napomena: Operateri moraju da nose antistatičke uređaje.
- Stručna lica moraju da provere da li postoji curenje rashladnog sredstva pre otvaranja kutije sa spoljnom jedinicom; obustavite montiranje ukoliko se otkrije curenje.
- Oprema za sprečavanje požara je pripremljena i preduzete su antistatičke mere predostrožnosti pre provere. Proverite cev za rashladno sredstvo kako biste videli da li ima oštećenja.

Bebednosna pravila za ugradnju klima uređaja

- Uređaj za sprečavanje požara mora biti pripremljen pre ugradnje
- Ugradnja se vrši na prostoru sa ventilacijom (otvorite vrata i prozore).
- Izvori paljenja, pušenje i telefoniranje nisu dozvoljeni u području gde se nalazi R32 rashladno sredstvo.
- Antistatičke mere predostrožnosti su neophodne prilikom instalacije klima uređaja, na primer odeća i rukavice od čistog pamuka.
- Držite detektor curenja u radnom stanju tokom instalacije.
- Ako tokom instalacije dođe do curenja R32 rashladnog sredstva, odmah utvrdite njegovu koncentraciju u zatvorenom okruženju dok dostiže siguran nivo. Ako curenje rashladnog sredstva utiče na rad klima uređaja, odmah prekinite rad uređaja. Klima uređaj mora prvo da se usisa, a zatim odmah odnese u centar za održavanje.
- Držite električne uređaje, prekidač za napajanje, utičnice, izvore toplote visoke temperaure i statike udaljene od donjih ivica unutrašnje jedinice.
- Klima uređaj će biti instaliran na pristupačnom mestu za ugradnju i održavanje, bez prepreka koje mogu blokirati vazdušne ulaze i izlaze unutrašnjih / spoljnih jedinica i biće udalje od **izvora toplote, zapaljivih ili eksplozivnih materija.**

- Kada instalirate ili popravljate klima uređaj i linija za povezivanje nije dovoljno duga, cela linija povezivanja zamenjuje se linijom povezivanja originalne specifikacije; produženje nije dozvoljeno.
- Koristite nove cevi za povezivanje, osim ako je urađeno proširavanje krajeva cevi.

Zahtevi u pogledu mesta ugradnje

- Izbegavajte mesta sa zapaljivim ili eksplozivnim curenjima gasova curenja ili gde postoje veoma agresivni gasovi.
- Izbegavajte mesta sa jakim elektro-magnetnim poljima.
- Izbegavajte bučna mesta.
- Izbegavajte teške prirodne uslove (na primer jake grmljavine, jak vetar, direktnu sunčevu svetlost ili visoke temperature).
- Izbegavajte mesta koja su u domašaju dece.
- Skratite vezu između unutrašnje i spoljne jedinice.
- Izaberite gde je lako izvesti servis i popravku i gde je ventilacija dobra.
- Spoljna jedinica ne treba da bude instalirana na način koji bi mogao dovesti do zauzimanja prolaza, stepeništa, požarnih stepenica, staze ili bilo koje druge javne površine.
- Spoljna jedinica bi trebalo da bude instalirana što dalje od komšijinih vrata i prozora i zelenih površina.

Provera instalacionog okruženja

- Proverite naznačenu tablicu na spoljnoj jedinici da biste utvrdili da li je rashladno sredstvo R32.
- Proverite veličinu prostorije. Prostor ne sme biti manji od naznačenog prostora (5m²) u specifikaciji. Spoljna jedinica mora biti postavljena na mestu sa dobrom ventilacijom.
- Proverite okolinu mesta instalacije: R32 ne sme biti instaliran u priloženom rezervisanom prostoru zgrade.
- Kada koristite električnu bušilicu kako biste napravili rupe u zidu, prvo proverite da li je na tom mestu ugrađen razvod za vodu, struju ili gas.

Zahtevi za montažnu konstrukciju

- Stalak za montažu mora da ispuni odgovarajuće nacionalne ili industrijske standarde u pogledu jačine tako da varovi i spojevi budu zaštićeni od rđe.
- Stalak za montažu i njegova nosiva površina mora biti u stanju da izdrže 4 puta više od težine jedinice, ili 200kg.

Napomene za postavljanje

- Kod montaže nosača na spoljnoj jedinici će biti pričvršćen zavrtnanj za proširenje.
- Uverite se da ste osigurali sigurnu instalaciju bez obzira na vrstu zida na kojem je uređaj instaliran, da bi se sprečilo potencijalno kapanje koje bi moglo povrediti ljude.

Zahtevi za zaštitu od električne energije

- Proverite da li snaga napona, namenjeno strujno kolo za napajanje klima uređaja i prečnik kabla za napajanje ispunjavaju nacionalne zahteve.
- Kada je maksimalna struja klima uređaja >16A, mora se koristiti prekidač vazduha ili uređaj za zaštitu od curenja. –
- Normalni radni opseg je 90%-110% lokalnog napona. Nedovoljno napajanje može rezultirati kvarom, strujnim udarom ili požarom. U slučaju nestabilnosti napona, predlaže se povećanje regulatora napona.
- Minimalna udaljenost između klima uređaja i zapaljivih materija je 1.5 m.
- Međuvezni kabl povezuje unutrašnju i spoljnu jedinicu. Pre nego što počnete povezivanje, prvo morate izabrati odgovarajuću veličinu kabla.
- Tipovi kablova: Kabl za napajanje: H07RN-F ili H05RN-F;
Međuvezni kabl: H07RN-F or H05RN-F;
- Minimalni poprečni presek kabla za napajanje i međuveznog kabla.

Severna Amerika

Amperaža uređaja (A)	AWG
10	18
13	16
18	14
25	12
30	10
40	8

Druzi regioni

Nazivna struja (A)	Nazivni poprečni presek (mm ²)
>3 i < 6	0.75
>6 i <10	1
>10 i <16	1.5
>16 i <25	2.5
>25 i <32	4
>32 i <40	6

- Veličina međuveznog kabla, kabla za napajanje, osigurača i prekidača je određena maksimalnom strujom uređaja. Maksimalna struja je naznačena na pločici koja se nalazi na bočnoj strani poklopca jedinice. Pogledajte tablicu da biste izabrali pravi kabl, osigurač ili prekidač.
- Napomena: Osnovna oznaka kabla odnosi se na detaljni dijagram ožičenja i nalazi se na uređaju koji ste kupili.

Notices for installation

Zahtevi za rad na visini

- Prilikom postavljanja jedinica na 2m ili više iznad nivoa baze, moraju se nositi sigurnosni pojasevi kao i užad dovoljno jaka da se bezbedno pričvrsti na spoljnu jedinicu, kako bi se sprečilo padanje koje bi moglo izazvati telesne povrede ili smrt, kao i materijalnu štetu.

Zahtevi za uzemljenje

- Klima uređaj spada u I vrstu električnih aparata i mora mu se obezbediti pouzdano uzemljenje.
- Nemojte povezivati uzemljenu žicu na cevi za gas, vodovodne cevi, gromobran, telefonske žice ili slabo uzemljena strujna kola.
- Žica za uzemljenje je specijalno dizajnirana i ne može se koristiti u druge svrhe, niti se može učvrstiti običnim šrafovim.
- Preporučeni prečnik međuveznog kabla je kao u uputstvu, tipa priključka za „nulu“, koji ispunjava lokalne standarde (unutrašnji prečnik priključka za „nulu“ treba da odgovara veličini zavrtnja jedinice, ne više od 4.2mm). Nakon ugradnje proverite da li su zavrtnji u dobrom položaju i da li postoji opasnost od labavljenja.

Ostalo

- Način povezivanja klima uređaja i naponskog kabla kao i način povezivanja svakog nezavisnog elementa ima šematski prikaz dodat uz uređaj.
- The model and rating value of the fuse shall be subject to the silkscreen on corresponding controller or fuse sleeve.

Sadržaj pakovanja

Sadržaj pakovanja unutrašnje jedinice

Naziv	Količina	Jed.
Unutrašnja jedinica	1	Set
Daljinski upravljač	1	Kom
Baterije (7#)	2	Kom
Uputstvo	1	Set
Odvodno crevo	1	Kom

Sadržaj pakovanja spoljne jedinice

Naziv	Količina	Jed.
Spoljna jedinica	1	Set
Crevo za povezivanje	2	Kom.
Plastična traka	1	Rolna
Zašt. prsten za crevo	1	Kom.
Ispuna	1	PAKET

NAPOMENA: Svi dodatni delovi su deo otvorenog konkretnog pakovanja, te ukoliko ima razlike s Vašim uređajem, molimo za razumevanje.

Postavljanje unutrašnje jedinice

Prikaz dimenzija za postavljanje unutrašnje jedinice

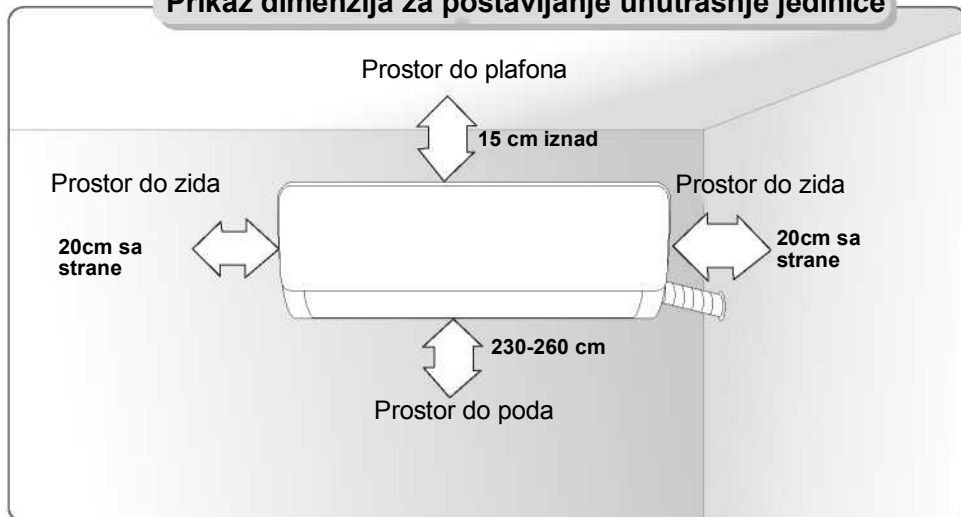

Montažna ploča

1. Zid na kome ćete postaviti unutrašnju jedinicu mora biti čvrst, akko bi sprečio vibracije.
2. Koristite krstasti tip šrafova kako biste nosač pričvrstili horizontalno za zid i montirali, pazeći na bočnu horizontalu i uzdužnu vertikalnu.
3. Povucite nosač rukom posle postavljanja da se uverite da je čvrsto vezan za zid.

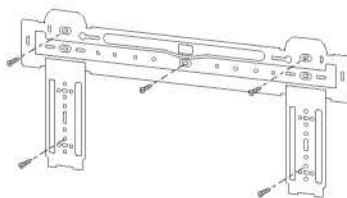

Bušenje rupa za cevi

1. Napravite rupu uz pomoć električne bušilice ili burgijom na unapred određene pozicije, sa spoljnim nagibom 5°-10°.
2. Da biste zaštilili cevi i kablove od oštećenja koja prolaze kroz zid, kao i od eventualnih glodara koji se nastanjuju u zidne šupljine, zaštitni prsten se zalemi i zapečati kitom.

Napomena: Rupe su obično debljine $\phi 60\text{mm}$ – $\phi 80\text{mm}$. Prilikom bušenja rupe, izbegavajte tvrde zidove i one na kojima su prethodno već instalirane cevi.

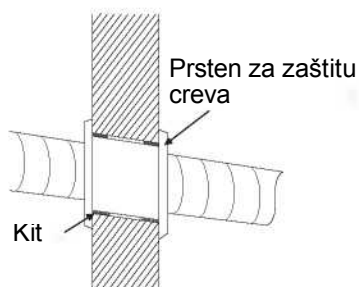

Postavljanje unutrašnje jedinice

Putanja creva

1. U zavisnosti od položaja jedinice, crevo može biti usmereno bočno sa leve ili desne strane (slika 1), ili vertikalno otopozadi (slika 2) (u zavisnosti od dužine cevi unutrašnje jedinice). U slučaju bočnog postavljanja, preseći izlaz na suprotnoj strani.

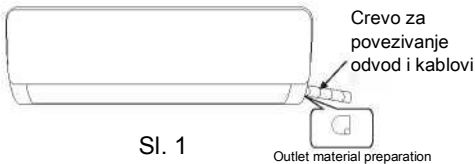

Sl. 1



Sl. 2

Povezivanje creva

1. Pomerite fiksni deo kako biste izvukli crevo iz unutrašnje jedinice. Odrnite rukom šestougaonu maticu u levo do kraja.

2. Spojite crevo za povezivanje sa unutrašnjom jedinicom:

Ciljajte u centar creva, zavijte maticu prstima u desno, a zatim dotegnite ključem, kao što je prikazano na slici. Obrtni momenat zatezanja je prikazan u tabeli.

Napomena: Proverite pažljivo pre instalacije da li na spojnicama postoje oštećenja. Spojne cevi između unutrašnje i spoljne jedinice se ne koriste ponovo, osim ako se ne uradi proširavanje krajeva cevi.

Tabela obrtnog momenta zatezanja

Veličina creva (mm)	Sila zatezanja (N · m)
Φ6/Φ6. 35	15—25
Φ9/Φ9. 52	35—40
Φ12/Φ12. 7	45—60
Φ15. 88	73—78
Φ19. 05	75—80

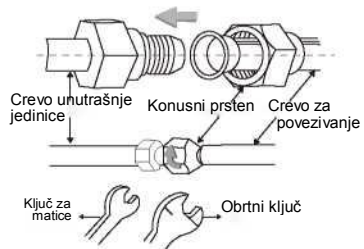

Obmotajte crevo

1. Koristite izolir traku da spojite delove unutrašnje jedinice i creva za povezivanje, a zatim uz pomoć izolacionog materijala obmotajte creva i zatvortite dobro kako bi se sprečilo stvaranje kondenzata vode na spoju.
2. Povežite izlaz za vodu sa odvodnom cevi, i čvrsto i pravo postavite spojena creva i kablove.
3. Koristite plastične pričvršćivače kako biste obmotali crevo za povezivanje, kablove i odvodno crevo. Pustite da slobodno pada nadole.



Postavljanje unutrašnje jedinice

Fiksiranje unutrašnje jedinice

1. Okačite unutrašnju jedinicu na kačaljke, i pomerajte uređaj levo desno da se uverite da su kuke dobro i čvrsto postavljene.
2. Gurnite ka donjoj levoj i gornjoj desnoj strani jedinicu prema kačaljka, dok kuka koja je postavljena ne uradi "klik".

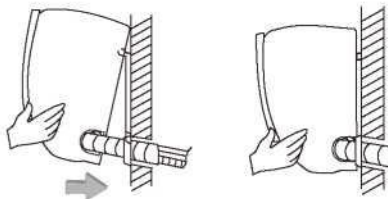

Dijagram povezivanja žica

- Ukoliko je uz klima uređaj obezbeđen kabl, žično povezivanje je fabrički odrađeno, tako da nema potrebe za povezivanjem.
- Ukoliko kabl nije obezbeđen, potrebno je povezivanje prema šematskom prikazu.

Nakon instaliranja proverite da li su:

1. zavrtnji u dobrom položaju i da li postoji opasnost od opuštanja.
2. konektor displejske ploče stavljen na pravo mesto i ne dodiruje ploču.
3. kontrolna kutija dobro zatvorena.

Konstantna brzina

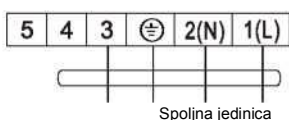

Varijabilna brzina

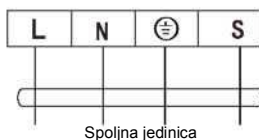

Konektor



Ukoliko postoji konektor, povežite direktno.

NAPOMENA:

- ✘ Ovaj priručnik obično uključuje režim povezivanja kablova za različite vrste klima uređaja. Ne možemo isključiti mogućnost da su neki drugi tipovi uređaja isto prikazani na šemi.
- ✘ Šematski prikaz je samo referenca. Ako je uređaj malo drugačiji, pogledajte detaljno šematski prikaz za povezivanje uređaja koji ste kupili.

Postavljanje unutrašnje jedinice

Prikaz dimenzija za postavljanje spoljne jedinice

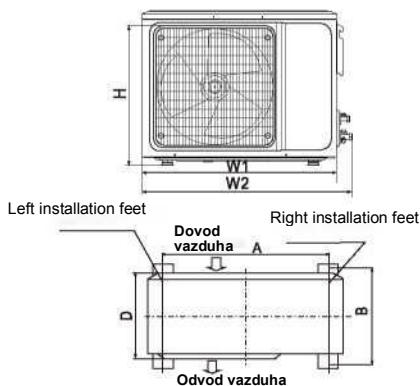
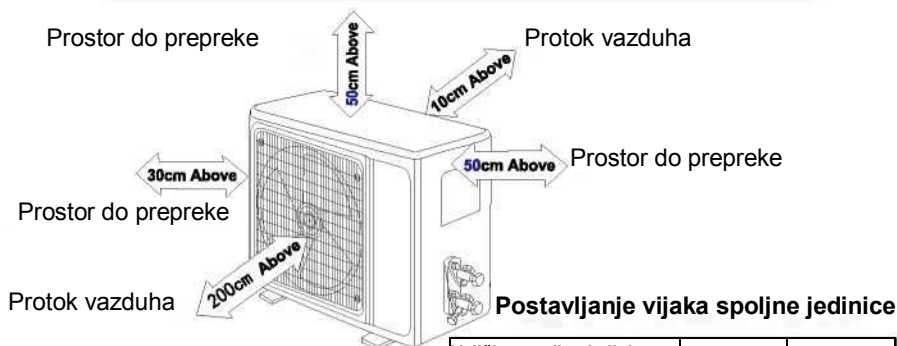

Veličina spoljne jedinice W1(W2)*H*D (mm)	A (mm)	B (mm)
665(710)x420x280	430	280
600(645)x485x260	400	290
660(710)x500x240	500	260
700(745)x500x255	460	260
730(780)x545x285	540	280
760(810)x545x285	540	280
790(840)x550x290	545	300
800(860)x545x315	545	315
800(850)x590(690)x310	540	325
825(880)x655x310	540	335
900(950)x700x350	630	350
900(950)x795x330	535	350
970(1044)x803x395	675	409

Postavljanje creva za povezivanje

Povežite spoljnu jedinicu sa crevom za povezivanje:

Usmerite kontra-otvor creva za povezivanje na kraj ventila, i zategnite konus maticu prstima.

Zatim zategnite konus navrtanj uz pomoć ključa.

* Kada produžavate cevi, mora se dodati još rashladnog sredstva, tako da ne bude doveden u pitanje rad i učinak klima uređaja.

Dužina creva	Količina rashl.sredstva koje se dodaje	Količina rashl. sredstva za jedinicu
s=5M	Nije potrebno	
5-15M	CCs=12000Btu	16g/m
	CC3=18000Btu	24g/m
		s=1kg
		=S2kg

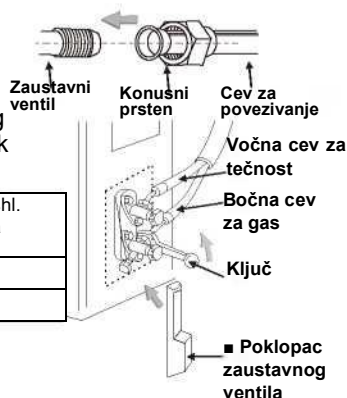

Napomena: 1. Ova tabela je samo za referencu.

2. Spojne cevi između unutrašnje i spoljne jedinice se ne koriste ponovo, osim ako se ne uradi proširavanje krajeva cevi.

3. Nakon ugradnje proverite da li je poklopac zaustavnog ventila dobro postavljen

Postavljanje spoljne jedinice

Povezivanje žica

1. Olabavite zavrtnje i uklonite poklopce iz jedinice.
2. Povežite kablove sa odgovarajućim terminalima spoljne jedinice (vidi dijagram povezivanja žica), a ako postoje signali vezani za utikač, samo ih ujedinite.
3. Uzemljenje žica: Uklonite vijak za uzemljenje iz električne konzole, pokrite kraj žice za uzemljenje na vijak i zavrnuti ga u uzemljenu rupu.
4. Fiksirajte kabl sa učvršćivačem.
5. Vratite poklopac u prvobitni položaj i pričvrstite ga zavrtnjima.

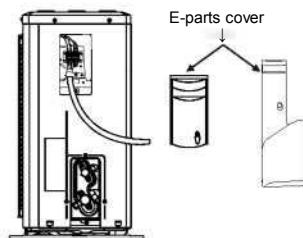

Dijagram povezivanja žica

Konstantna brzina

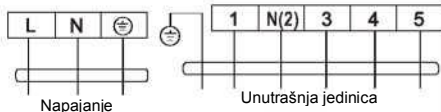
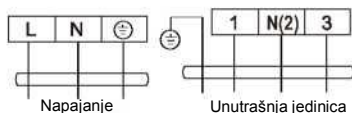

Varijabilna brzina

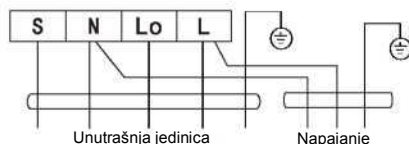
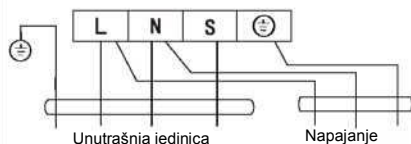

Konektor



Ako postoji konektor, povežite direktno.

NAPOMENA:

- ✘ Ovaj priručnik obično uključuje režim povezivanja kablova za različite vrste klima uređaja. Ne možemo isključiti mogućnost da su neki drugi tipovi uređaja isto prikazani na šemi.
- ✘ Šematski prikaz je samo referenca. Ako je uređaj malo drugačiji, pogledajte detaljno šematski prikaz za povezivanje uređaja koji ste kupili.

Postavljanje spoljne jedinice

Vakuumiranje

★ Za rashladno sredstvo R32 koristi se posebna pumpa za vakuum.

Pre svih radova na klima, skinite poklopac stop ventila (ventili za gas i tečnost) i budite sigurni da ste ga pritegli posle (da bi se sprečilo potencijalno curenje vazduha).

1. Da bi se sprečilo curenje vazduha i prosipanje zategnite matice kod svih cevi.
2. Povežite ventil, crevo za punjenje, glavni ventil i vakuum pumpu.
3. Potpuno otvorite ručicu i ostavite pumpu da radi najmanje 15 minuta i proverite da li su očitavanja multimetra -0.1MPa (-76cmHg).
4. Nakon nanošenja vakuuma, otvorite ventil heksagonalnim ključem.
5. Proverite da li su i otvoreni i zatvoreni konektori bez curenja.

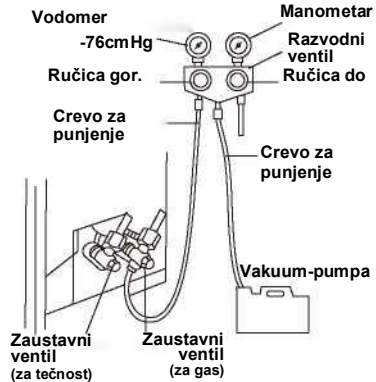

Spoljni odvod kondenzata (samo za toplotne pumpe)

Za vreme grejanja, kondenzovana i odledjena voda bi trebalo da se odvede crevom za odvod kondenzata.

Postavljanje:

Povežite spoljni konektor za odvod kondenzata (otvor $\Phi 25$) na osnovnoj ploči, i crevo za odvod kondenzata, tako da otpadna voda stvorena u spoljnoj jedinici, može da se sprovede napolje.

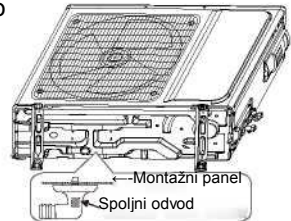

Provera nakon postavljanja i test funkcionisanja

Provera nakon postavljanja

★ Provera zaštite od električne energije

1. Proveriti da li napon odgovara.
2. Proveriti da li postoji bilo kakva neispravna veza ili loše priključenje struje, signala i uzemljene žice.
3. Da li su uzemljene žice sigurno i pravilno uzemljene.

★ Provera bezbednosti instalacija

1. Da li je instalacija sigurna.
2. Da li voda glatko otiče..
3. Da li su žice i kablovi pravilno postavljeni.
4. Proveriti da slučajno neki deo nije ostao nutar jedinice.
5. Check the refrigerant pipeline is protected well.

★ Testiranje curenja rashladnog sredstva

U zavisnosti od načina instalacije, mogu se primeniti sledeći metodi za utvrđivanje i proveru u delovima kao što su 4 konekcije spoljne jedinice kao i jezgara odvodnih ventila i T-ventila:

1. Metod mehurića: Nanesite jednaki sloj spreja ili sapunice na sumnjivo mesto gde bi moglo curiti i pažljivo posmatrajte hoće li doći do mehurića.
2. Metod Instrument: Proveriti curenje dodirujući sondu detektora za curenje u skladu sa uputstvima o sumnjivim tačkama gde može doći do curenja.

Napomena: Pre provere vodite računa o dobroj ventilaciji.

Test funkcionisanja

Priprema za test funkcionisanja:

- * Proverite da li su sve cevi i kablovi dobro povezani.
- ※ Proverite da li su ventili na gasnoj i tečnoj strani potpuno otvoreni.
- ※ Povežite napojni kabl sa utičnicom.
- * Stavite baterije u daljinski upravljač.

Napomena: Pre testiranja vodite računa o dobroj ventilaciji.

Koraci testa funkcionisanja

1. Uključite klima uređaj i pritisnite dugme ON/OFF na daljinskom upravljaču da biste pokrenuli uređaj.
2. Izaberite Hlađenje, Grejanje (nije dostupno kod modela koji su samo za hlađenje), SWING i druge režime rada uz pomoć daljinskog upravljača da proverite da li uređaj radi ispravno.

Oprez:

Kontaktirajte ovlašćene servisne centre radi održavanja ovog uređaja. Održavanje od strane nekvalifikovane osobe može prouzrokovati opasnost.

Napunite klima uređaj R32 rashladnim sredstvom i održavajte uređaj strogo u skladu sa zahtevima proizvođača. Poglavlje se uglavnom fokusira na posebne zahteve za održavanje uređaja sa R32 rashladnim sredstvom. Zamolite servisera da pročita ova tehnička uputstva radi potpunog upoznavanja.

Neophodne kvalifikacije osoblja za održavanje klima uređaja

1. Pored uobičajene obuke za popravku i rad sa rashladnim uređajima, za rad na uređajima sa zapaljivim rashladnim sredstvima neophodna je dodatna obuka. U mnogim zemljama ovu obuku obavljaju akreditovane nacionalne organizacije i to u skladu sa standardima kompetentnosti koji su propisani zakonom. Stečena kompetentnost dokumentuje se sertifikatom.
2. Održavanje i popravak klima uređaja mora se voditi prema postupku koji preporučuje proizvođač. Ako su drugi stručnjaci potrebni za pomoć pri održavanju i popravci klima uređaja, postupak se mora sprovesti pod nadzorom osoba koje imaju kvalifikaciju za popravku klima uređaja sa zapaljivim rashladnim sredstvom.

Provera mesta

Pre bilo kakvog održavanja uređaja sa R 32 rashladnim sredstvom, moraju se preuzeti odgovarajuće bezbednosne mere kako bi se smanjio rizik od opasnosti. Proverite da li je mesto dobro provetreno, kao i ispravnost antistatičke i protivpožarne opreme. Tokom održavanja sistema za hlađenje pratite sledeće mere predostrožnosti.

Operativne procedure

1. Područje rada:
Osoblje koje radi na održavanju, kao i ostali koji su uključeni u rad, moraju biti upoznati sa prirodom posla koji obavljaju. Područje radnog prostora treba odvojiti i proveriti uslove, odnosno uveriti se da u radnom prostoru nema zapaljivog materijala.
2. Provera prisustva rashladnog sredstva:
Pre i tokom rada potrebno je odgovarajućim detektorom rashladnih sredstava prekontrolisati područje rada kako bi tehničar imao uvid u potencijalno prisustvo toksičnog ili zapaljivog materijala u vazduhu. Vodite računa da oprema za detektovanje curenja rashladnih sredstava odgovara svim rashladnim sredstvima, odnosno da nema varničenja, da je sve dobro zapečaćeno i zatvoreno.
3. Prisustvo aparata za gašenje požara:
Ukoliko se izvode bilo kakvi vrući radovi na opremi za hlađenje ili sličnim delovima, neophodno je da vam pri ruci bude aparat za gašenje požara. U blizini područja rada treba imati suvi prah ili aparat za gašenje požara.

Održavanje

4. Bez izvora paljenja:

Nijedno lice koje obavlja rad na rashladnom sistemu i izloženo je radu sa cevima ne sme koristiti nikakve izvore paljenja na način koji može dovesti do eksplozije ili požara. Svi izvori paljenja, uključujući dim od cigareta moraju biti dovoljno udaljeni od mesta instalacije, popravke, pomeranja ili odlaganja tokom kojih rashladno sredstvo može dospeti u okolni prostor. Pre početka rada ispitajte da li postoje zapaljive opasnosti ili rizik od paljenja. Znak "Zabranjeno pušenje" treba da bude istaknut.

5. Ventilacija područja rada (otvorite vrata i prozore):

Vodite računa da je područje rada otvoreno ili da je adekvatno provetreno pre otvaranja rashladnog sistema ili izvođenja vrućih radova. Ventilacija područja mora da traje tokom izvođenja radova. Ventilacijom prostora bezbedno se u atmosferu izbacuje bilo koje potencijalno rashladno sredstvo.

6. Provera rashladne opreme

Ukoliko se menjaju električni delovi, oni moraju biti odgovarajuće svrhe i ispravne specifikacije. Moraju se pratiti uputstva proizvođača i servisa. Ukoliko imate bilo kakve nedoumice, konsultujte se sa tehničkim sektorom proizvođača. Za instaliranja tokom kojih se koriste zapaljiva rashladna sredstva moraju se obaviti sledeće provere:

- Količina punjenja je u skladu sa veličinom prostorije u kojoj su instalirani delovi sa rashladnim sredstvom.
- Ventilacija i utičnice rade adekvatno i neometano.
- Ukoliko se koristi indirektno rashladno kolo, treba proveriti da li u sekundarnom kolu ima rashladnog sredstva.
- Cev za hlađenje ili komponente ugrađuju se u položaj u kome je malo verovatno da će biti izložene bilo kojoj supstanci koja može da dovede do korozije komponenti koje sadrže rashladno sredstvo, osim ako su komponente sastavljene od materijala koji su inherentno otporni na koroziju ili su odgovarajuće zaštićeni od korodiranja.

7. Provera električnih uređaja:

Popravka i održavanje električnih komponenti obuhvata inicijalne bezbednosne provere i postupke provere komponenti. Ako postoji neka greška koja bi mogla ugroziti sigurnost, onda ne treba povezati električno napajanje sve dok se problem ne reši na zadovoljavajući način. Ako greška ne može odmah da se ispravi, ali je neophodno nastaviti rad, primenjuje se adekvatno privremeno rešenje. Kvar se prijavljuje vlasniku opreme i sve strane se uključuju u savetovanje.

Initial safety checks shall include:

- Pražnjenje kondenzatora: ovo se radi pažljivo kako bi se izbegla opasnost od varničenja.
- Provera da tokom punjenja, popravke ili čišćenja sistema ne postoji nikakva izloženost električnim komponentama ili ožičavanju.
- Vodite računa o stalnom pravilnom uzemljenju.

Provera kabela

Proverite kabl od habanja, korozije, prenapona, vibracije, kao i da li ima oštih ivica i drugih štetnih efekata u okruženju. Tokom provere treba uzeti u obzir uticaj starenja i kontinuiran uticaj vibracije kompresora i ventilatora na njega.

Provera curenja rashladnog sredstva R32

Napomena: Proverite curenje rashladnog sredstva u okruženju u kome nema potencijalnog izvora paljenja. Ne treba koristiti nikakvu halogenu sondu (ili bilo koji drugi detektor koji koristi otvoreni plamen).

Načini uočavanja curenja:

Za sisteme koji koriste rashladno sredstvo R 32 postoji instrument za detekciju curenja, ali detekcija curenja se ne sme izvoditi u okruženju sa rashladnim sredstvom. Vodite računa da detektor curenja ne postane izvor paljenja i da se primenjuje samo na izmerenoj količini rashladnog sredstva. Detektor curenja mora biti podešen na minimalnu koncentraciju zapaljivog rashladnog sredstva (u procentima). Kalibrišite i prilagodite pravilnu koncentraciju gasa (ne više od 25%) sa korišćenim rashladnim sredstvom. Tečnost koja se koristi u detekciji curenja primenjuje se na većinu rashladnih sredstava. Nemojte koristiti hloridne rastvore kako biste sprečili reakciju između hlora i rashladnih sredstava i koroziju bakarne cevi.

Ukoliko sumnjate na curenje, odmah otklonite svaki oblik vatre sa područja rada ili ugasisite vatru. Ako mesto curenja treba da se zavari, treba izolovati sva rashladna sredstva sa mesta curenja (pomoću prekidnog ventila). Pre i tokom zavarivanja, koristite OFN kako biste pročistili ceo sistem.

Uklanjanje i vakuumiranje

1. Vodite računa da nema izvora paljenja blizu vakuum pumpe i da postoji dobra ventilacija.
2. Održavanje i drugi radovi na rashladnom kolu treba da se izvode u skladu sa opštom procedurom, ali kada se zapaljivost uzme u obzir, sledeće operacije su ključne. Molimo vas da pratite sledeće postupke:
 - Uklanjanje rashladnog sredstva.
 - Dekontaminiranje cevi inertnim gasovima.
 - Evakuacija.
 - Ponovno dekontaminiranje cevi inertnim gasovima.
 - Sečenje ili zavarivanje cevi.
3. Rashladno sredstvo treba vratiti u odgovarajući skladišni rezervoar. Produvati sistem azotom bez kiseonika. Ponovite proces nekoliko puta. Ovaj proces se ne sme izvoditi upotrebom kompresovanog vazduha ili kiseonika.

Održavanje

3. Procesom produvanja u sistem ulazi anaerobni nitrogen i dostiže radni pritisak pod vakuumskim stanjem, a zatim se azot bez kiseonika emituje u atmosferu i na kraju vakuumira sistem. Ponavljajte proces dok se sasvim ne očisti rashladno sredstvo u sistemu. Nakon poslednjeg punjenja anaerobnim nitrogenom, gas se ispušta u atmosferu i možete zavariti sistem. Neophodno je uraditi ovaj proces da bi se sistem zavarilo.

Proces punjenja rashladnog sredstva

Uz opšti postupak, neophodno je ispuniti i sledeće zahteve:

- Vodite računa da ne postoji kontaminacija između različitih rashladnih sredstava kada koristite uređaj za punjenje rashladnog sredstva. Cev za punjenje rashladnog sredstva treba da bude što kraća, kako bi se smanjili ostaci rashladnog sredstva u njoj. T
- Rezervoari za skladištenje treba da stoje vertikalno.
- Vodite računa da su mere uzemljenja već preduzete pre nego što se rashladni sistem napuni rashladnim sredstvom.
- Nakon završetka punjenja (ili dok još nije završeno) markirajte sistem.
- Vodite računa da ne prepunite rashladno sredstvo.

Otpad i oporavak materijala

Otpad:

Pre ovog postupka tehničko osoblje se upoznaje sa opremom i njenim karakteristikama i pružena im je preporučena obuka. Za recikliranje rashladnog sredstva, pre samog rada treba analizirati uzorke rashladnog sredstva. Adekvatno se pripremite za testiranje uzorka.

1. Upoznajte se sa opremom i postupkom.
2. Isključite električno napajanje.
3. Pre postupka vodite računa da:
 - Ukoliko je to neophodno, mehaničkom opremom olakšajte rad rezervoara za hlađenje.
 - Imate adekvatnu zaštitnu opremu i koristite je ispravno.
 - Postupak mora da se izvodi po nadzorom kvalifikovanog osoblja.
 - Postupak mora biti u skladu sa nacionalnim standardima.
4. Ako je moguće, rashladni sistem treba vakuumirati.
5. Ako je stanje vakuuma nemoguće postići, izvadite rashladno sredstvo u svakom delu sistema sa više mesta.
6. Pre početka oporavka, treba osigurati da je kapacitet rezervoara dovoljan.
7. Pokrenuti i upravljati opremom za oporavak u skladu sa uputstvima proizvođača.

8. Ne punitite rezervoar do punog kapaciteta (zapremina unešene tečnosti ne sme da prelazi 80% ukupne zapremine rezervoara).
9. Čak i da je kratkog trajanja, ne smete premašivati maksimum radnog pritiska rezervoara.
10. Nakon završetka punjenja rezervoara i kraja postupka rada, vodite računa da se rezervoari i oprema brzo uklone i da svi ventili budu zatvoreni.
11. Oporavljena rashladna sredstva ne smeju se ubacivati u druge sisteme pre prečišćavanja i testiranja.

Napomena: Nakon otpada uređaja i eliminacije rashladnog sredstva treba uraditi identifikaciju koja sadrži datum i odobrenje. Vodite računa da se u identifikaciji napominju zapaljiva rashladna sredstva ovog uređaja.

Oporavak:

1. Prilikom oporavka ili otpada uređaja treba uraditi čišćenje rashladnog sredstva. Najbolje je potpuno ukloniti rashladno sredstvo.
2. Kada punitite rezervoar za skladištenje rashladnim sredstvom, može se koristiti samo specijalan rezervoar za hlađenje. Vodite računa da kapacitet rezervoara odgovara količini rashladnog sredstva. Svi rezervoari koji se koriste za oporavak rashladnih sredstava moraju imati identifikaciju rashladnog sredstva (Rezervoar za oporavak rashladnog sredstva). Rezervoari za skladištenje moraju biti opremljeni ventilom za otpuštanje pritiska i globusnim ventilima i moraju biti u dobrom stanju. Ukoliko je to moguće, prazni rezervoari pre upotrebe treba da budu evakuisani i da se drže na sobnoj temperaturi pre upotrebe.
3. Opremu za oporavak treba držati u dobrom radnom stanju i opremljenu uputstvima za upotrebu. Oprema bi trebalo da bude pogodna za oporavak R32 rashladnih sredstava. Pored toga, treba da postoji i kvalifikovani uređaj za merenje težine koji se može koristiti. Crevo treba da bude povezano odvojivim spojem, ne sme biti curenja i mora se nalaziti u dobrom stanju. Pre upotrebe opreme za oporavak, proverite da li je u dobrom stanju i da li je dobro održavana. Proverite da li su električne komponente zaptivene kako bi se sprečilo curenje rashladnog sredstva i požara. Ako imate bilo kakvo pitanje, molimo vas da se obratite proizvođaču.
4. Oporavljeno rashladno sredstvo se utovara u specijalne rezervoare i vraća proizvođaču uz praćenje uputstava za transport. Nemojte mućkati rashladno sredstvo niti u opremi za oporavak niti u rezervoaru za skladištenje.
5. R32 ne može se transportovati otvoreno. U slučaju transporta preuzmite neophodne anti elektrostatičke mere. Tokom transporta, utovara i istovara moraju se poštovati odgovarajuće zaštitne mere da bi se sprečilo oštećenje klima uređaja.
6. Kada uklanjate kompresor ili čistite ulje kompresora, vodite računa da je kompresor napumpan do odgovarajućeg nivoa, kako biste bili sigurni da nema ostataka R32 rashladnog sredstva u lubrikantnom ulju. Vakuumiranje treba uraditi pre nego što vratite kompresor dobavljaču. Pridržavajte se bezbednosnih mera prilikom pražnjenja ulja iz sistema.

Ovaj dokument je originalno proizveden i objavljen od strane proizvođača, brenda Vox, i preuzet je sa njihove zvanične stranice. S obzirom na ovu činjenicu, Tehnoteka ističe da ne preuzima odgovornost za tačnost, celovitost ili pouzdanost informacija, podataka, mišljenja, saveta ili izjava sadržanih u ovom dokumentu.

Napominjemo da Tehnoteka nema ovlašćenje da izvrši bilo kakve izmene ili dopune na ovom dokumentu, stoga nismo odgovorni za eventualne greške, propuste ili netačnosti koje se mogu naći unutar njega. Tehnoteka ne odgovara za štetu nanесenu korisnicima pri upotrebi netačnih podataka. Ukoliko imate dodatna pitanja o proizvodu, ljubazno vas molimo da kontaktirate direktno proizvođača kako biste dobili sve detaljne informacije.

Za najnovije informacije o ceni, dostupnim akcijama i tehničkim karakteristikama proizvoda koji se pominje u ovom dokumentu, molimo posetite našu stranicu klikom na sledeći link:

<https://tehnoteka.rs/p/vox-inverter-klima-iva5-24jr-akcija-cena/>