

Uputstvo za upotrebu

SAMSUNG prečišćivač vazduha AX40R3030WM/EU

SAMSUNG



Tehnoteka je online destinacija za upoređivanje cena i karakteristika bele tehnike, potrošačke elektronike i IT uređaja kod trgovinskih lanaca i internet prodavnica u Srbiji. Naša stranica vam omogućava da istražite najnovije informacije, detaljne karakteristike i konkurentne cene proizvoda.

Posetite nas i uživajte u ekskluzivnom iskustvu pametne kupovine klikom na link:

<https://tehnoteka.rs/p/samsung-preciscivac-vazduha-ax40r3030wmeu-akcija-cena/>

Directory

Safety Precautions	3
Confirmations before use	9
Accessories / Product specification	9
Checking the air purifier	10
Main body	10
Display and buttons	11
Disassembling the filter	12
Assembling the filter	13
Using the air purifier	15
Turning the power on/off / Fan speed / Sleep mode	15
Timer function / Lighting function / Lock function	16
Filter reset function / Checking the air cleanness	17
Use of dongle / Clean and dry pre filter	18
Cleaning and maintenance	19
Cleaning the exterior of the air purifier / Cleaning the sensors	19
Cleaning the air outlet	20
Others	21
Troubleshooting	21



***Correct Disposal of This Product
(Waste Electrical & Electronic Equipment)***

(Applicable in countries with separate collection systems)

This marking on the product, accessories or literature indicates that the product and its electronic accessories (e.g. charger, headset, USB cable) should not be disposed of with other household waste at the end of their working life. To prevent possible harm to the environment or human health from uncontrolled waste disposal, please separate these items from other types of waste and recycle them responsibly to promote the sustainable reuse of material resources.

Household users should contact either the retailer where they purchased this product, or their local government office, for details of where and how they can take these items for environmentally safe recycling. Business users should contact their supplier and check the terms and conditions of the purchase contract. This product and its electronic accessories should not be mixed with other commercial wastes for disposal.

For information on Samsung's environmental commitments and product-specific regulatory obligations, e.g. REACH, WEEE, Batteries, visit: www.samsung.com/uk/aboutsamsung/sustainability/environment/our-commitment/data/

Safety Precautions





These safety precautions are for owner's safety and preventions of property damage. Therefore, please read this manual thoroughly before using your product.

WARNING

Hazards or unsafe practices that may result in severe personal injury or death.

CAUTION

Hazards or unsafe practices that may result in minor personal injury or property damage.

-  Follow directions.
-  Do NOT attempt.
-  Unplug the power plug from the wall socket.
-  Do NOT disassemble.

FOR INSTALLATION

WARNING

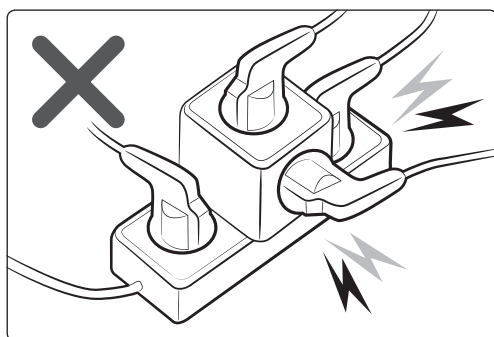

Plug the power cord into a wall socket with the power specifications of the product or higher and use the socket for this appliance only. Also, do not extend the power cord on your own.

- Sharing a wall socket with other appliances using a multi outlet power strip or extending the power cord may result in electric shock or fire.
- Do not use an electric transformer. It may result in electric shock or fire.
- If the voltage/frequency/rated current condition is different, it may cause electric shock or fire.

-  **Do not install this appliance near a heater, inflammable material. Do not install this appliance in a humid, oily or dusty location, in a location exposed to direct sunlight and water (rain drops). Do not install this appliance in a location where gas may leak.**

- Failure to do so may result in electric shock or fire.

Safety Precautions

⚠ CAUTION

❗ **The appliance should be installed in a place where the power cord of the product can be easily pulled out.**

- Failure to do so may result in electric shock or fire due to electric leakage.

Install your appliance on a level and hard floor that can support its weight.

- Failure to do so may result in abnormal vibrations, noise, or problems with the product.

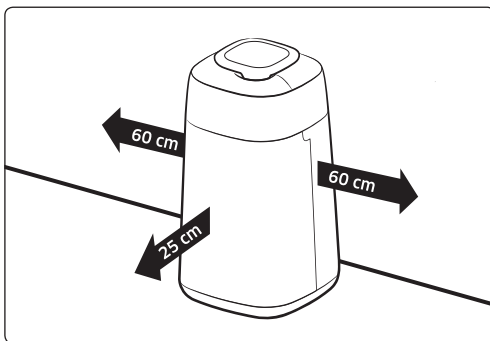

When installing the appliance, allow enough space around the appliance.

- Space between both sides of the product and the wall: At least 60 cm or more, Space in front of the product: 25 cm or more
- If enough space for air intake is not provided, purifying capacity may deteriorate.
- Make sure obstacles such as a curtain do not block air inlet or outlet of the appliance.

When installing the product, make sure that no heavy objects are on the power cord (or cable).

- Failure to do so may result in electric shock or fire.

For power supply

⚠ WARNING

❗ **Remove all foreign substances such as dust or water from the power plug terminals and contact points using a dry cloth on a regular basis.**

- Failure to do so may result in electric shock or fire.

When plugging in the appliance, the power plug should face downward.

- If the power plug faces in the opposite direction, the electric wires within the cable may be damaged and this may result in electric shock or fire.

When the product, power plug or power cord is damaged, contact your nearest service center.

If the supply cord is damaged, it must be replaced by the manufacturer, its service agent or similarly qualified persons in order to avoid a hazard.

These instructions shall also be available in an alternative format, e.g. on a website.

- ⊘ **Plug the power plug into the wall socket firmly. Do not use a damaged power plug, damaged power cord or loose wall socket.**

- Failure to do so may result in electric shock or fire.

When unplugging the product, do not pull the power cord. Grip the power plug, and then pull the power plug.

- Failure to do so may result in electric shock or fire.

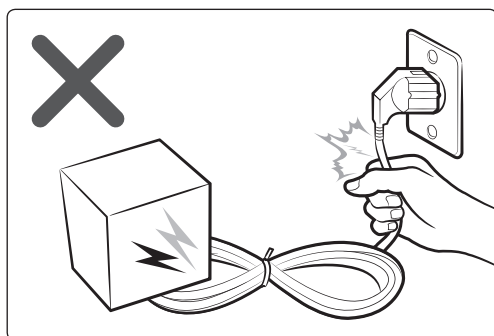

Do not pull or excessively bend the power cord. Do not twist or tie the power cord. Do not hook the power line over a metal object, place a heavy object on the power cord, insert the power line between objects, or push the power cord into the space behind the appliance.

- This may result in electric shock or fire.

⚠ CAUTION

- ⚡ **When the air purifier will not be used for a long period of time or during a thunder or lightning storm, disconnect the power supply.**

- Failure to do so may result in electric shock or fire.

It is dangerous when the power cable gets damaged, therefore contact a service center or qualified experts for the repair.

Before cleaning or repairing the appliance, unplug the appliance.

For operation

⚠ WARNING

- ⚡ **If the appliance is flooded, turn off the appliance and contact a service center.**

- Failure to do so may result in electric shock or fire.

If the appliance generates a strange noise, a burning smell or smoke, disconnect the power supply immediately and contact a service center.

- Failure to do so may result in electric shock or fire.

In the event of a gas leak (such as propane gas, LP gas, etc.), ventilate immediately without touching the appliance or power cord and contact a service center or a qualified technician.

- Do not use a ventilating fan.
 - If there is a spark, explosion or fire may occur.

Safety Precautions

Do not unplug the appliance during operation.

- When plugging the appliance in again, flame may occur and it may result in electric shock or fire.

When a repair is needed, contact the service center.

- Failure to do so may result in a product malfunction, water leakage, electric shock or fire.

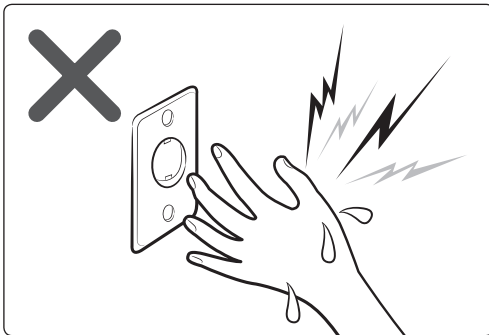

Do not touch the power plug with wet hands.

- This may result in electric shock.

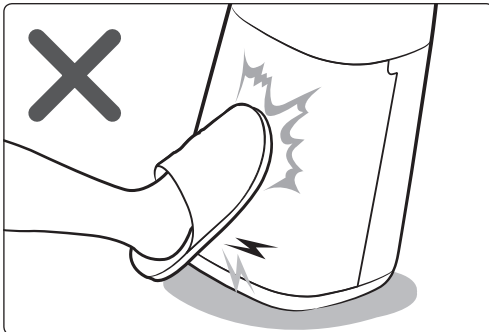

Do not apply a force to or pull the product using excessive force.

- This may result in fire, injury, or a problem with the product.

After unpacking the air purifier, keep all packaging materials out of the reach of children.

- If a child places a bag over its head, it may suffocate.

Do not insert your fingers or a foreign substances into the air outlet while product is operating.

- Take special care that children do not injure themselves by inserting their fingers into the product.



Do not place an object near the product that makes it possible for children to climb onto the machine.

- The child could fall and injure themselves or the product may fall over and injure the child.

If water has entered the power supply module, unplug the power cable and dry the product completely before use.

- Failure to do so may result in electric shock or fire.

Do not put other foreign materials such as metal into the product.

- This may result in electric shock or injury.

Do not place heavy objects on the product.

- Failure to do so may result in a product malfunction or noise.

⚠️ If a foreign substance such as water has entered the product, disconnect the power supply and contact the service center.

- Failure to do so may result in electric shock or fire.

⚠️ Do not attempt to repair, disassemble, or modify the product yourself.

- Do not use a fuse (such as copper, steel wire, etc.) other than a standard fuse.
- Failure to do so may result in electric shock, fire, a product malfunction or injury.

⚠️ CAUTION

⚠️ Keep a distance of about 2 m from other electric appliances such as a TV, video or audio device etc.

- Failure to do so may result in reduced video quality or noise.

Leave enough space between the product and a wall.

- Space between both sides of the product and the wall: At least 60 cm or more, Space in front of the product: 25 cm or more
- This products is designed to take the room air from the front side of the product for purifying process. Therefore, make sure there is no obstacles in front of the product and near air intake and outlet.

⊘ Do not stand on top of the product or place objects (such as laundry, lighted candles, lighted cigarettes, dishes, chemicals, metal objects, etc.) on the product.

- This may result in electric shock, fire, a product malfunction or injury.

Safety Precautions

Do not tilt or turn the product upside down while the product is connected to the wall outlet.

- Failure to do so may result in a malfunction or fire.

Do not spray volatile material such as insecticide onto the product.

- As well as being harmful to humans, this may also result in electric shock, fire or a product malfunction.

Do not put the product into water.

- This may result in a product malfunction.

Do not operate the product with wet hands.

- This may result in electric shock.

This appliance is not intended for use by persons (including children) with reduced physical, sensory or mental capabilities, or lack of experience and knowledge, unless they have been given supervision or instruction concerning use of the appliance by a person responsible for their safety. Children should be supervised to ensure that they do not play with the appliance.

- ⊘ **For use in Europe:** This appliance can be used by children aged from 8 years and above and persons with reduced physical, sensory or mental capabilities or lack of experience and knowledge if they have been given supervision or instruction concerning use of the appliance in a safe way and understand the hazards involved. Children shall not play with the appliance. Cleaning and user maintenance shall not be made by children without supervision.

For cleaning



WARNING



Do not clean the product by spraying water directly onto it. Do not use benzene, thinner, acetone or alcohol to clean the product.

- This may result in discoloration, deformation, damage, electric shock or fire.

Disconnect the power supply and stop the fan operation before cleaning the product.

- Potential risk of electric shock or fire.



CAUTION



Unplug the power plug before cleaning the product.

Confirmations before use

Accessories

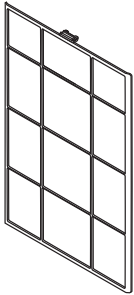

Pre filter 1EA

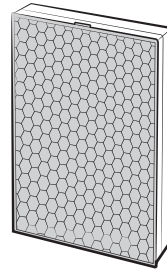

2-in-1 filter 1EA
(Deodorization Filter+Dust
Collecting Filter)



User manual 1 EA

Product specification

Dimension of the product is based on maximum value of the measurement.
Measurement may vary depending on the side.

For product improvement purposes, design and specifications of the product are subject to change without prior notice.

Model & Name	AX40R3030WM
Product dimension (W*H*D)	350 mm*640 mm*350 mm
Effective area	40 m ²

Checking the air purifier

Main body

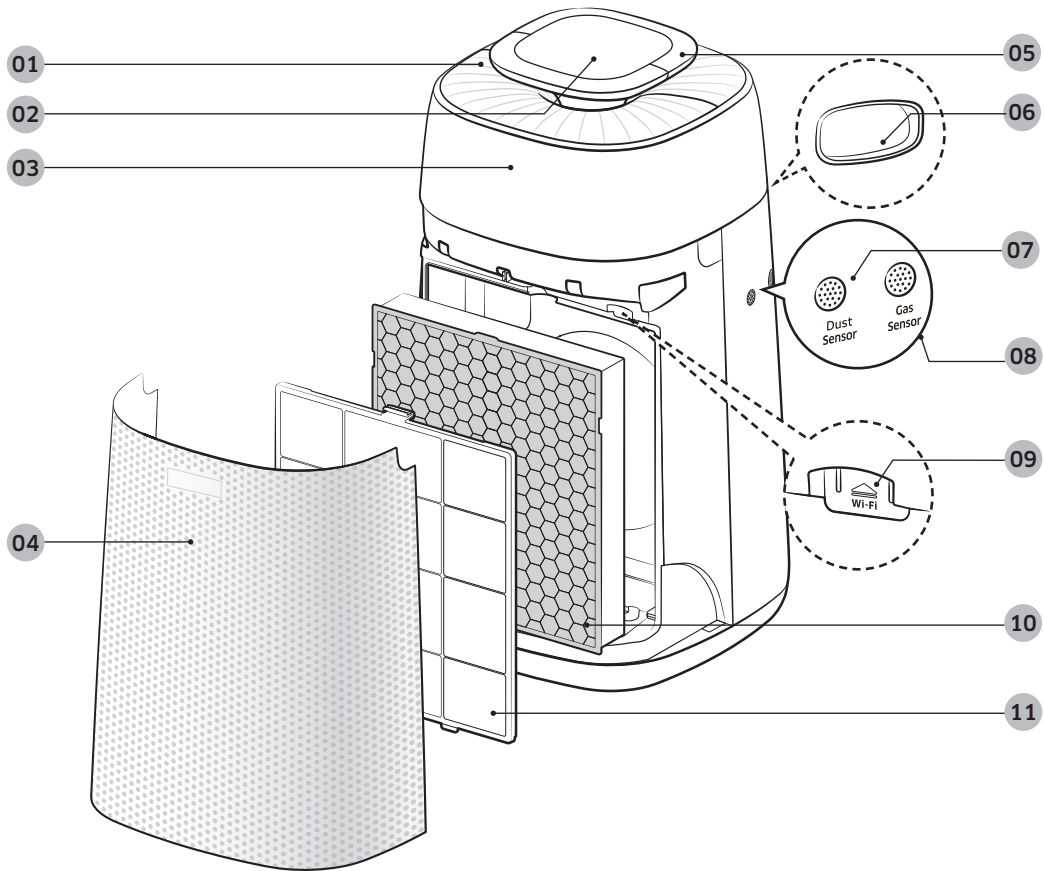

01 Air outlet

02 Display and buttons

03 Lighting

04 Air inlet/ front panel

05 Handle (top)

06 Handle (at the rear side)

07 PM10 sensor

08 Gas sensor

09 Dongle

- This model does not support smart function. You cannot install a dongle to this model.

10 2-in-1 filter (Deodorization Filter+Dust Collecting Filter)

11 Pre filter

Display and buttons

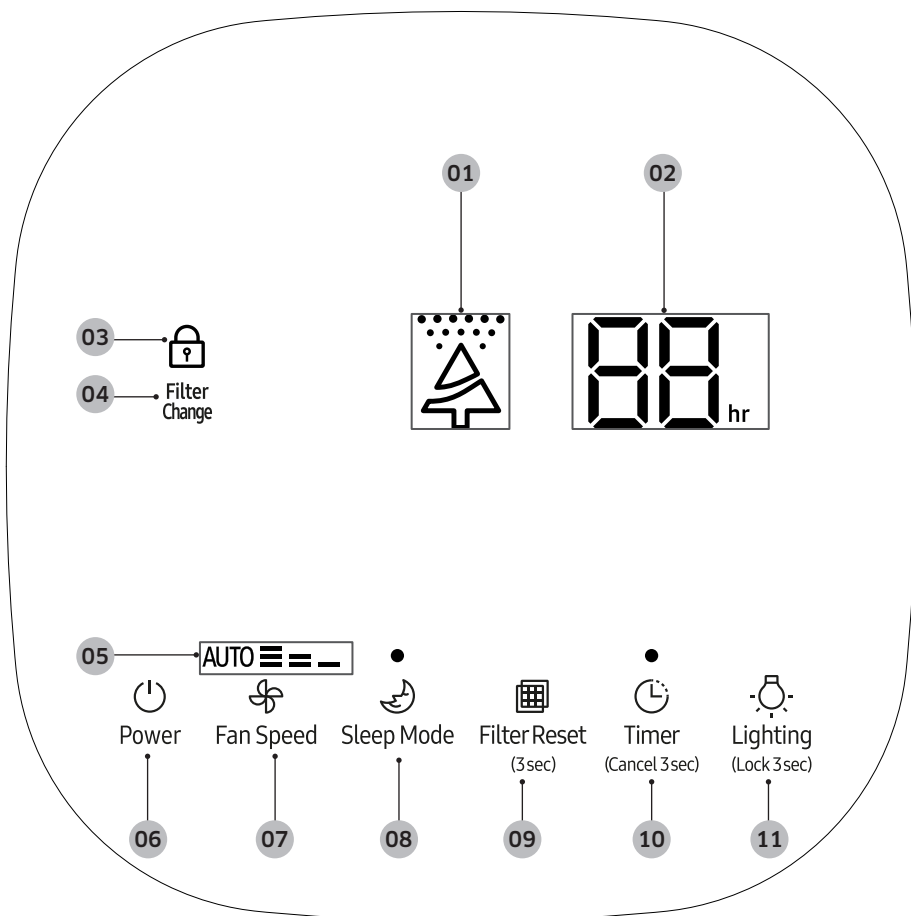

01 Comprehensive Air-quality indicator

02 Timer indicator

03 Child-Lock indicator

04 Filter replacement indicator

05 Fan speed indicator

06 Power button

07 Fan speed button

08 Sleep mode button

09 Filter reset button

10 Timer button

11 Lighting function/Child-Lock button

Checking the air purifier

Disassembling the filter

When using the 2-in-1 filter for the first time or replacing them with a new set, remove the vinyl packaging first.

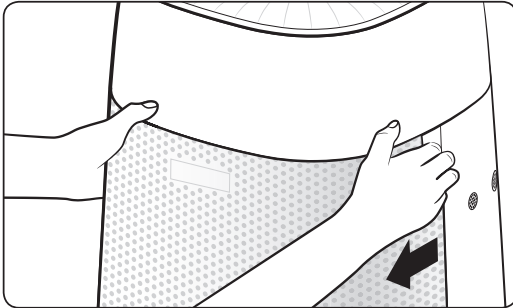

STEP 1 Open the cover front

- ▶ Press the top part of the product with your thumb and pull the cover front with other fingers.

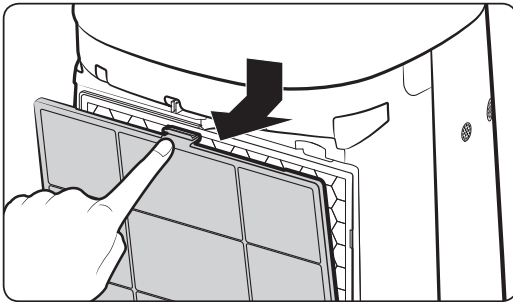

STEP 2 Disassemble the Pre filter

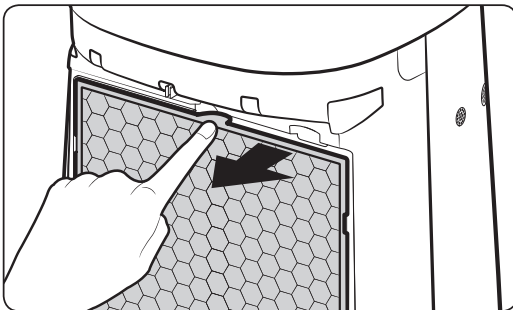

STEP 3 Disassemble the 2-in-1 filter

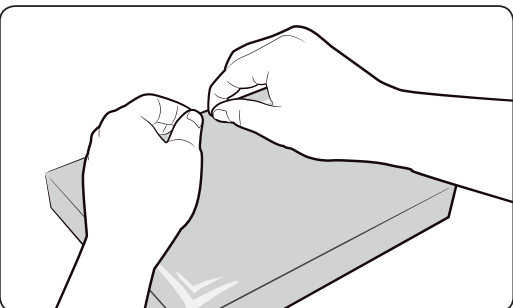

STEP 4 Replace the 2-in-1 filter

- ▶ Remove the vinyl packaging of the new 2-in-1 filter.

Assembling the filter

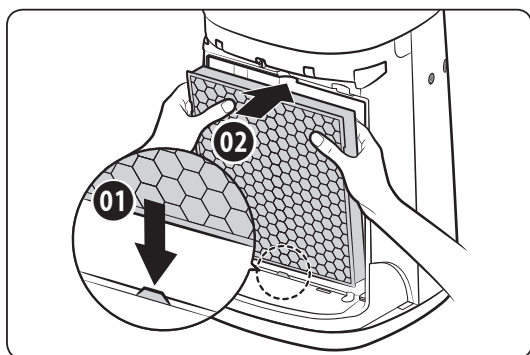

STEP 1 Put the 2-in-1 filter

- ▶ Insert the filter on the grooves at the bottom to fix the filter.

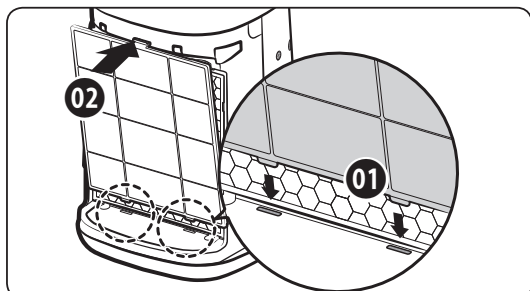

STEP 2 Put the Pre filter

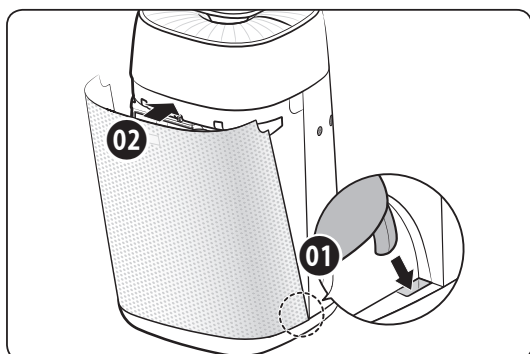

STEP 3 Close the cover front

- ▶ Insert the hooks on the grooves at the bottom first.

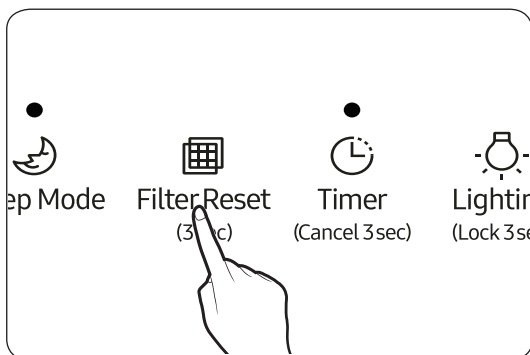

STEP 4 Insert the filter and reset the filter

- ▶ Press the  button for more than 3 seconds.

Checking the air purifier

Using the filter

- ▶ If you operate the air purifier without the filters, air purification performance will decrease.
- ▶ New filter may smell strange when you operate the product for the first time after purchasing it.
 - However, it will disappear naturally in few days.
- ▶ Please close the windows and doors when operating the product. However, concentration level of carbon dioxide may increase if you operate the product for a long time with windows closed. Therefore, ventilate the room regularly between use. When filter is saturated with just a weak odor, ventilating the room will help get rid of saturated odor.
- ▶ Carbon monoxide (CO) is a major harmful gas that cannot be filtered by the air purifier and it usually gets indoor from outside.
- ▶ Cleaning and replacement interval of the filter may vary depending on the operating environment.
- ▶ When using or replacing 2-in-1 filter, be sure to remove the plastic covered on the filter.
- ▶ If you operate the product without 2-in-1 filter, sound of the air flow can be abnormally loud. Make sure to insert the 2-in-1 filter before using the product.
- ▶ Deodorization function of the air purifier is effective when air is penetrates through the filter. Therefore when there's excessive odor in your room, ventilate the room first and use the air purifier afterwards to eliminate remaining odors for more effective deodorization.
- ▶ If you operate the air purifier during cooking a food that generates strong odor, lifetime of the Deodorization filter will be shortened significantly. Also if the odor is too strong, Deodorization filter may get saturated with the odor and you may smell that odor when you use the product after ventilating the room. Use the air purifier for eliminating the remaining odor after ventilating the room.
- ▶ The filter replacement indicator will light up when the product has reached the maximum usages hours which was initially programmed. Therefore replacement cycle may vary depending on the operating environment.
- ▶ Do not wash the 2-in-1 filter with water. Always keep them away from moisture while the air purifier is in use.
- ▶ If you use the 2-in-1 filter for 24 hours per day, you can use it for six months to one year maximum. (If you use it less than that, the lifespan will be longer.) The lifespan is depended on the degree of air pollution. The more dust is accumulated, the shorter the lifespan of filter is.
- ▶ If the lifespan approaches to the end, the light is on. However, even before the light indicates the replacement timing, please replace it with new filter, if the filter is severely polluted, generates heavy odor or the wind is rapidly weakened.
- ▶ The antibacterial ultra-fine filter is a high performance filter to remove fine dust and smoke particles in the air.
- ▶ The antibacterial ultra-fine filter is treated with anti-allergy process. It is effective to remove allergic materials.
- ▶ The charcoal deodorizing filter is high performance filter to effectively remove odor from toilet or cooking.
- ▶ If the 2-in-1 filter is saturated with odor and the air purifier stinks, please replace the new 2-in-1 filter.
- ▶ User needs to undertake filter replacement cost produced during the period of free maintenance.
- ▶ You can purchase a new filter from a nearby Samsung Electronics service center.

Using the air purifier

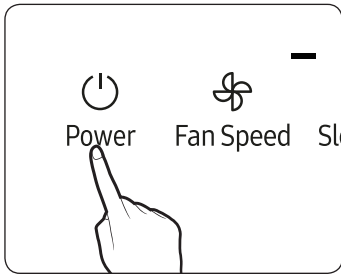

Turning the power on/off

- ▶ The air purifier turns on with a ringing sound and begins purification.
 - When you turn on the air purifier, Sensor loading indication will be displayed for 30 seconds and then Comprehensive Air-quality indicator will be displayed.

※ Sensor loading indication

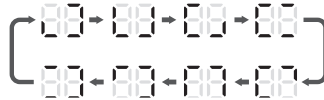

- ▶ If you turn off the power and turn it back on, the product will operate in the last fan speed you used.

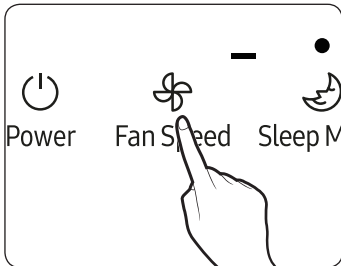

Fan speed

You can select desired fan speed when purifying the air.

- ▶ Press the [] button to select the desired fan speed.
 - Fan speed will be selected in following order repeatedly: Low→Auto→High→Medium→Low.
- ▶ If you select Auto, the air purifier will adjust the fan speed automatically according to dust and odor in the surrounding area to maintain clean indoor air quality.

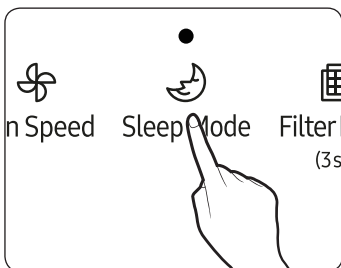

Sleep mode

You can sleep comfortably in a quiet and comfortable indoor environment with the sleep mode.

- ▶ When the sleep mode runs, the sleep mode indicator light is on at the display.
- ▶ If the sleep mode runs for 10 seconds or a longer time and other fan mode is selected, you will see the Sensor loading indication on the display. (Please refer to `Turning the power on/off` - `Sensor loading indication`)
- ▶ When the sleep mode runs, the lock function will not work.

Cancel

- ▶ Press the [] button or [] button.

Using the air purifier

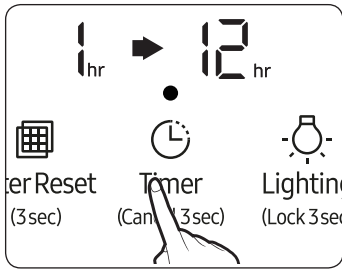



Timer function

You can set the Timer to turn off the purifier at desired time.

- ▶ Press the [] button you can select the time of the Timer from 1 hour to maximum 12 hours in 1 hour unit.
- ▶ The Timer function will run after 3 seconds when you set it to turn off the purifier at desired time.

Cancel

- ▶ Press the [] button for 3 seconds or set the time of the Timer to .

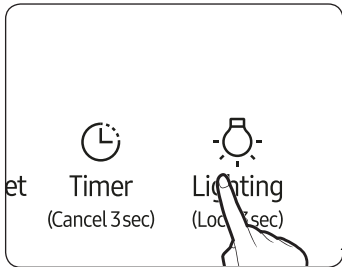

Lighting function

The mood lighting at the upper end of the product is divided into 4 colors according to the air quality.

- ▶ The air-quality indicator is not on during identification of the sensor preparation status on the display.
- ▶ The air-quality indicator function is off during operation of the sleep mode.

Cancel

- ▶ Press the [] button. (Lock 3sec)

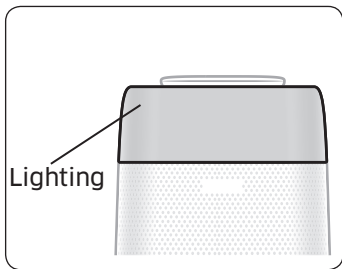

Lock function

You can lock the buttons to prevent the button from being pressed unwillingly, or by children.

- ▶ Press the [] button for over 3 seconds, you can hear `Ding` and the buttons will be locked.

- ▶ When buttons are locked, the [] will display.
- ▶ When buttons are locked, all the buttons will not work.

Cancel

- ▶ Press the [] button for over 3 seconds. (Lock 3sec)

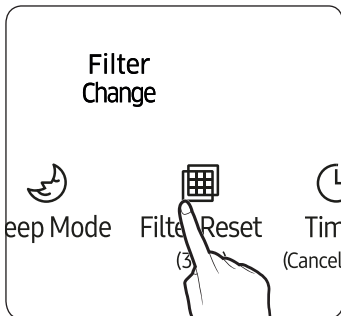

Filter reset function

This function let users know when to change the filter.

- ▶ During operation of the air purifier, change with a new 2-in-1 filter if the [Filter Change] indicator is on and emits a beep; after change, long press the [Filter Reset] button for more than 3 seconds to reset, during which the [Filter Change] indicator flashes twice while emitting the “Ringing” sound.
- ▶ In case of changing the filter due to other reasons even if the [Filter Change] indicator is not on, long press the [Filter Reset] button for more than 3 seconds to reset.

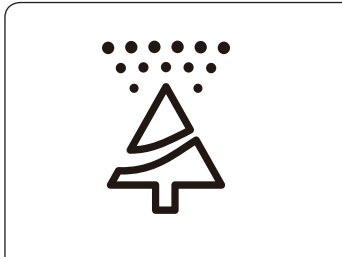

Checking the air cleanness

Comprehensive air-quality confirmation

- ▶ The comprehensive air-quality indicator identification will be divided into four levels according to the cleanness of dust and gaseous pollutants (smell) and performed with different colors.
- ▶ Identification level of the comprehensive air-quality indicator:
Blue → Green → Yellow → Red
(Clean ← → Polluted)

Remark

- In case of using fragrance, smell-removal spray, cleaning agent and other volatile odor products, the comprehensive air-quality indicator identification may vary.
- The comprehensive air-quality indicator is judged comprehensively according to the concentration level of dust and gaseous pollutants.
 - The comprehensive air-quality indicator identification is displayed in color corresponding to the worst level amongst the dust and gaseous pollutant concentration. That is, the indicator is displayed in red when the concentration of gaseous pollutants appears serious pollution with the dust concentration in good condition.
- Under the condition that the concentration of gaseous pollutants (smell) has been high, the comprehensive air-quality indicator identification displays in a fixed color.
- In the environment under the influence of electromagnetic wave, the comprehensive air-quality indicator identification may also be temporarily displayed in red.

Using the air purifier

Clean and dry pre filter

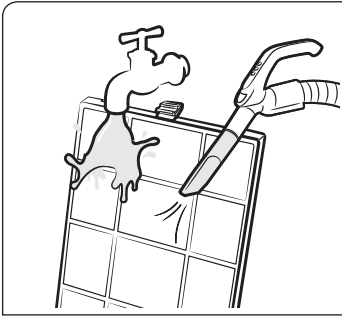

Clean pre filter

- ▶ Remove big dust through dust collector in case of serious dust pollution, and then softly wash through warm water with neutral washing agent.
 - Pre Filter (clean intervals: two weeks, 24 hours each day)

⚠ CAUTION

- Brush or similar tools may damage the pre filter.

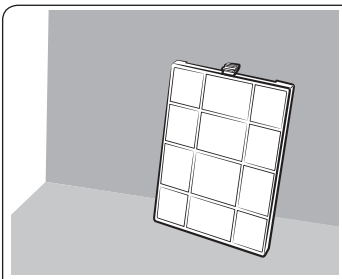

Dry pre filter

- Dry completely in shade.

Cleaning and maintenance

Cleaning the exterior of the air purifier

CAUTION

- **Please make sure the air purifier is stopped, and pull out the plug from the power socket in the wall while cleaning.**
- ▶ Dip a towel in warm water and wring it out before using it to clean the product.
- ▶ Use a cotton swab or exclusive cleaning (superfine fiber) cloth to clean the groove.
- ▶ If it's too hard to clean the dust on the cover front, remove the cover and wash it with water.

CAUTION

- Do not clean the air purifier with an alkali detergent.
- Do not clean the surface of the air purifier with sulfuric acid, hydrochloric acid or organic solvent (thinner, kerosene, acetone, etc.), or attach a sticker to the unit. This may damage the surface of the air purifier.

Cleaning the sensors

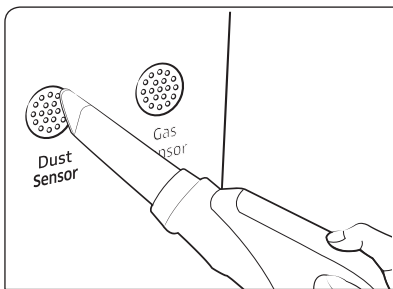

- If there's dust or foreign substances on the sensor, use a vacuum cleaner to clean the sensor and its surrounding.
- If there's any foreign substances on the sensor, it may not perform properly.

CAUTION

- Do not put any dust in the sensor parts.

Cleaning and maintenance

Cleaning the air outlet

- If the air outlet is dirty, re-assemble it after removal and cleaning of the grille.
- If other matters fall into the air outlet, re-assemble it after removal of the air outlet grille.

Grille Removal and Assembling

Disassembling the grille

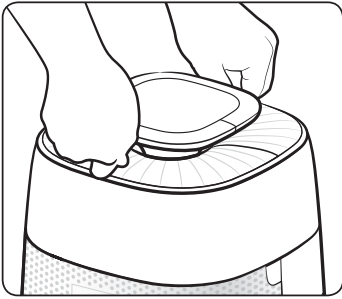

STEP 1
Grip the front and rear grille as shown.

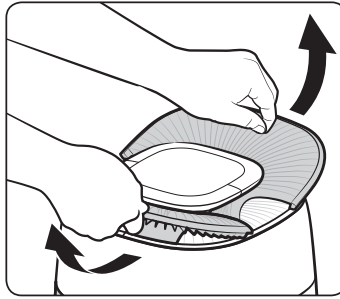

STEP 2
Take the grille out to form the V type.

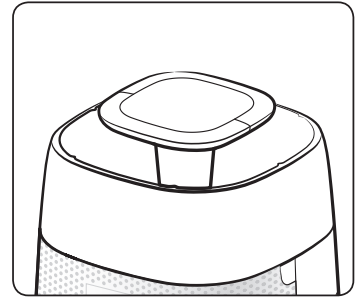

STEP 3
Remove the grille completely.

Assembling the grille

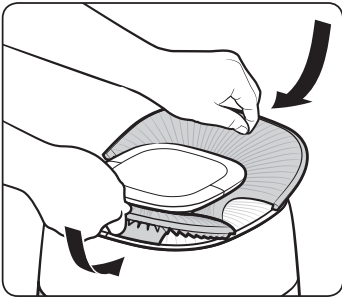

STEP 1
Insert the grille in the front and rear direction of the display as shown.

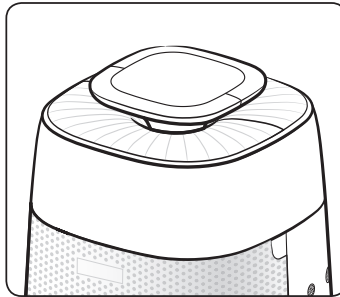

STEP 2
Flatten the inserted grille.

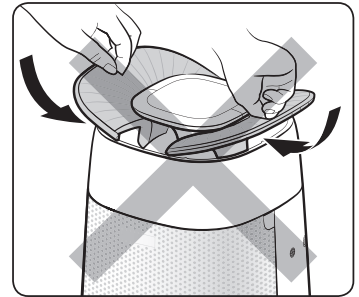

Remark
• Do not insert the grille in the left and right direction of the display.

Troubleshooting

Refer to the following chart if the air purifier operates abnormally. This may save time and unnecessary expenses.

Problem	Solution
Product is not working	<ul style="list-style-type: none"> ▪ Check if the power is on and try to turn on the air purifier again. ▪ Check if the power plug is connected properly and turn on the air purifier again. If the product still don't work, try connecting the power plug to other power outlets.
Abnormal noise	<ul style="list-style-type: none"> ▪ You may hear abnormal noise if moving the running product, please power off before moving. ▪ You may hear sensor running sound while operating the air purifier, it is a normal phenomenon, you can use it reassurance.
There is a strange odor	<ul style="list-style-type: none"> ▪ Check the Pre filter and clean it if it's dirty. ▪ If the 2-in-1 filter is saturated with strange odor, please replace a new 2-in-1 filter. User needs to undertake filter replacement cost produced during the period of free maintenance.
The Comprehensive Air-quality indicator always is fixed on red. (Something is wrong with the Comprehensive Air-quality indicator)	<ul style="list-style-type: none"> ▪ Check the sensors for any foreign substances and clean them if necessary. ▪ In winter season if you operate the product immediately after product was delivered, dew may form on the sensor due to temperature difference (between outdoor and indoor). In this case, the comprehensive Air-quality indicator may turned red. In this case, indicator will become normal after 1~2 hours of operation. ▪ If you cook or if outside air gets indoor and affects changes in odor, gas sensor may detect odor and the Comprehensive Airquality indicator may become red. Ventilate the room for 1 ~ 2 hours. ▪ Disconnect the power plug and connect it back on after a minute and operate the product. (Reset the sensors) ▪ If you have followed all the solution indicated in this section and the Comprehensive Air-quality indicator is still red, there might be a problem with sensor or wires. Please contact the service center.

Troubleshooting

Problem	Solution
Fan speed is not changing according to the Comprehensive Air-quality.	<ul style="list-style-type: none"> Set the fan speed to Auto. When the fan speed is set to High, Medium, Low, or Sleep, the fan speed will not change automatically.
Filter replacement indicator not turning off	<ul style="list-style-type: none"> After replacing the 2-in-1 filter, press the  [Filter Reset] for <small>(3sec)</small> over 3 seconds to reset the filter replacement alert.
Strange indication is displayed	<ul style="list-style-type: none"> If you see [103, 154, 163], contact the service center.
Air out only from the rear side	<ul style="list-style-type: none"> The design is intended for purifying the air efficiently with the wind rising through whirling. As the wind flows in the clockwise direction, you may feel that the front side is weaker while the rear side is stronger for the wind flown out from the upper air outlet.

Memo

QUESTIONS OR COMMENTS?

COUNTRY	CALL	OR VISIT US ONLINE AT
UK	0330 SAMSUNG (7267864)	www.samsung.com/uk/support
IRELAND (EIRE)	0818 717100	www.samsung.com/ie/support
GERMANY	06196 77 555 66 *HHP 06196 77 555 77 *OTH	www.samsung.com/de/support
FRANCE	01 48 63 00 00	www.samsung.com/fr/support
ITALIA	800-SAMSUNG (800.7267864)	www.samsung.com/it/support
SPAIN	91 175 00 15	www.samsung.com/es/support
PORTUGAL	808 207 267	www.samsung.com/pt/support
LUXEMBURG	261 03 710	www.samsung.com/be_fr/support
NETHERLANDS	088 90 90 100	www.samsung.com/nl/support
BELGIUM	02-201-24-18	www.samsung.com/be/support (Dutch) www.samsung.com/be_fr/support (French)
NORWAY	21629099	www.samsung.com/no/support
DENMARK	707 019 70	www.samsung.com/dk/support
FINLAND	030-6227 515	www.samsung.com/fi/support
SWEDEN	0771 726 786	www.samsung.com/se/support
POLAND	801-172-678* lub +48 22 607-93-33* Specjalistyczna infolinia do obsługi zapytań dotyczących telefonów komórkowych: 801-672-678* * (opłata według taryfy operatora)	http://www.samsung.com/pl/support/
HUNGARY	0680SAMSUNG (0680-726-7864)	www.samsung.com/hu/support
AUSTRIA	0800 72 67 864 (0800-SAMSUNG)	www.samsung.com/at/support
SWITZERLAND	0800 726 78 64 (0800-SAMSUNG)	www.samsung.com/ch/support (German) www.samsung.com/ch_fr/support (French)
CZECH	800 - SAMSUNG (800-726786)	www.samsung.com/cz/support
SLOVAKIA	0800 - SAMSUNG (0800-726 786)	www.samsung.com/sk/support
CROATIA	072 726 786	www.samsung.com/hr/support
BOSNIA	055 233 999	www.samsung.com/support
MONTENEGRO	020 405 888	www.samsung.com/support
SLOVENIA	080 697 267 (brezplačna številka)	www.samsung.com/si/support
SERBIA	011 321 6899	www.samsung.com/rs/support
ALBANIA	045 620 202	www.samsung.com/al/support
BULGARIA	*3000 Цена в мрежата 0800 111 31 , Безплатна телефонна линия	www.samsung.com/bg/support
ROMANIA	*8000 (apel in retea) 08008-726-78-64 (08008-SAMSUNG) Apel GRATUIT Atenție: Dacă efectuați apelul din rețeaua Digi (RCS/RDS), vă rugăm să ne contactați formând numărul Telverde fără ultimele două cifre, astfel: 0800872678.	www.samsung.com/ro/support
CYPRUS	8009 4000 only from landline, toll free	www.samsung.com/gr/support
GREECE	80111-SAMSUNG (80111 726 7864) only from land line (+30) 210 6897691 from mobile and land line	
LITHUANIA	8-800-7777	www.samsung.com/lt/support
LATVIA	8000-7267	www.samsung.com/lv/support
ESTONIA	800-7267	www.samsung.com/ee/support



Air purifier

User manual

AX40R3030WM

- Thank you for purchasing this Samsung air purifier.
- Before operating this unit, please read this user manual carefully and retain it for future reference.

SAMSUNG

Ovaj dokument je originalno proizveden i objavljen od strane proizvođača, brenda Samsung, i preuzet je sa njihove zvanične stranice. S obzirom na ovu činjenicu, Tehnoteka ističe da ne preuzima odgovornost za tačnost, celovitost ili pouzdanost informacija, podataka, mišljenja, saveta ili izjava sadržanih u ovom dokumentu.

Napominjemo da Tehnoteka nema ovlašćenje da izvrši bilo kakve izmene ili dopune na ovom dokumentu, stoga nismo odgovorni za eventualne greške, propuste ili netačnosti koje se mogu naći unutar njega. Tehnoteka ne odgovara za štetu nanесenu korisnicima pri upotrebi netačnih podataka. Ukoliko imate dodatna pitanja o proizvodu, ljubazno vas molimo da kontaktirate direktno proizvođača kako biste dobili sve detaljne informacije.

Za najnovije informacije o ceni, dostupnim akcijama i tehničkim karakteristikama proizvoda koji se pominje u ovom dokumentu, molimo posetite našu stranicu klikom na sledeći link:

<https://tehnoteka.rs/p/samsung-preciscivac-vazduha-ax40r3030wmeu-akcija-cena/>