

Uputstvo za upotrebu

HISENSE televizor 32A5100F

Hisense

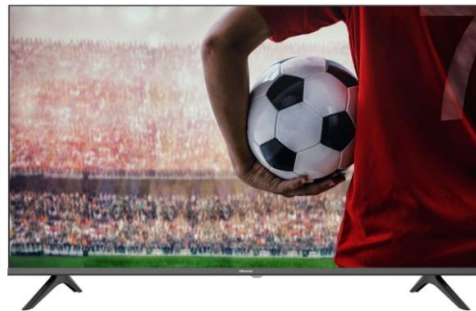

Tehnoteka je online destinacija za upoređivanje cena i karakteristika bele tehnike, potrošačke elektronike i IT uređaja kod trgovinskih lanaca i internet prodavnica u Srbiji. Naša stranica vam omogućava da istražite najnovije informacije, detaljne karakteristike i konkurentne cene proizvoda.

Posetite nas i uživajte u ekskluzivnom iskustvu pametne kupovine klikom na link:

<https://tehnoteka.rs/p/hisense-televizor-32a5100f-akcija-cena/>



QUICK SETUP GUIDE

Before using the TV, please read this guide thoroughly and retain it for future reference.

Important Notice

Paragraphs beginning with the symbol  indicate important instructions, tips or conditions for the following settings.

 **For your own safety and the optimal performance of your TV, ensure to read the safety instructions before performing any installation.**

It is not guarantee operation and performance of peripheral devices made by other manufacturers. We disclaim any liability or damage that may arise from operation and/or performance from usage of such other maker's peripheral devices.

The recording and playback of content on this or any other device may require permission from the owner of the copyright or other such rights in that content. It is your responsibility to ensure that your use of this or any other device complies with applicable copyright legislation in your country. Please refer to that legislation for more information on the relevant laws and regulations involved or contact the owner of the rights of the content you wish to record or playback.

The Index/Glossary explains certain terms used in this user manual and in the TV menu.

Read these instructions

Follow all instructions

Heed all warnings

Keep these instructions

All rights reserved.





Safety Instructions

To ensure safe and correct use of this product, always comply with the following precautions to avoid dangerous situations and damage to your unit:

	CAUTION RISK OF ELECTRIC SHOCK DO NOT OPEN	
CAUTION: TO REDUCE THE RISK OF ELECTRIC SHOCK, DO NOT REMOVE COVER (OR BACK). NO USER-SERVICEABLE PARTS INSIDE. REFER SERVICING TO QUALIFIED SERVICE PERSONNEL.		

 The lightning flash with arrowhead symbol, within an equilateral triangle is intended to alert the user to the presence of uninsulated dangerous voltage within the product's enclosure that may be of sufficient magnitude to constitute a risk of electric shock.

 The exclamation point within an equilateral triangle is intended to alert the user to the presence of important operating and maintenance (servicing) instructions in the literature accompanying the appliance.

 AC voltage: This symbol indicates that the rated voltage marked with the symbol is AC voltage.



Class II product : This symbol indicates that it does not require a safety connection of protective earthing (ground).

The intended use and ambient conditions for this TV

This TV is intended for the rendering of video and audio signals, on a table-top or wall-mounted, in a home or office environment. It must not be used in rooms with a high level of humidity or dust concentration. The warranty is only valid if used as intended by the manufacturer.



WARNING

High humidity and dust concentration may lead to current leaks in the device. To reduce the risk of fire or electrical shock:

- **Do not expose this unit to rain, moisture, dripping or splashing water, and do not place objects filled with liquids, such as vases, cups, etc. on or over the unit.**
- **Do not touch the TV with wet hands.**
- **Do not expose to direct air-conditioning and keep candles or other naked flames away from the TV at all times.**

If the TV is moved from a cold environment to a hot environment, leave it switched off for at least an hour to avoid condensation. If used outside, make sure it is protected from moisture.

If you notice anything unusual, immediately remove the power plug.

In case of fire, use preferably a CO₂ gas or powder fire extinguisher. If such extinguishers are not accessible, try to isolate the electrical supply before using a water fire extinguisher.

WARNING

Never place a television set in an unstable location. A television set may fall, causing serious personal injury or death. Many injuries, particularly to children, can be avoided by taking simple precautions such as:

- Using cabinets or stands recommended by the manufacturer of the television set.
- Only using furniture that can safely support the television set.
- Ensuring the television set is not overhanging the edge of the supporting furniture.
- Not placing the television set on tall furniture (for example, cupboards or bookcases) without anchoring both the furniture and television set to a suitable support.
- Not placing the television set on cloth or other materials that may be located between the television set and supporting furniture.
- Educating children about the dangers of climbing on furniture to reach the television set or its controls.

If your existing television set is being retained and relocated, the same considerations as above should be applied.

■ Moving/Transportation

Before moving this TV, disconnect all cables and move in the vertical position only. Grasp the device on the upper and lower edges of the frame.

- Do not press or put stress on the front panel of the TV. It may take two or more people to carry larger TVs.

If you have to briefly lay down the TV, place the unit with its entire front surface lying flat on soft material.

The LED screen is made of glass and can break if is not handled properly. Always wear rubber gloves to carry the unit. If the LED screen is damaged, liquid crystal might leak out. In case of skin contact, immediately rinse thoroughly with water.

■ Power Supply

Incorrect voltages can damage the TV. Only connect this unit to a power supply with the correct voltage and frequency noted on the type plate, using the supplied power cable.

The power plug must be easily accessible so that the device can be disconnected at all time. The unit is live, even in standby mode, as long as the unit is connected to a power outlet.

It is recommended that this unit is placed on a dedicated circuit.

- Do not overload the power outlets by connect too many appliances to the same outlet. Overloaded wall outlets, extension cords, etc. are dangerous and can result in electric shock and fire.

After power off, don't turn it on again in 5 seconds. Frequent switching power supply in a short period of time can cause abnormal TV.

■ Power plug and power cable

- Do not touch the power plug with wet hands.
- Do not place heavy objects on the power cable. Route the cable so that it is not kinked or laid over sharp edges, walked on or exposed to chemicals. A power cable with damaged insulation can cause electric shock and fire.
- Pull the power plug, NOT on the cable when disconnecting. The cable can become damaged and cause a short circuit if pulled on.
- Do not place the power cable near a high temperature object.
- Do not move the TV with the power cable plugged into a socket.
- Do not use a damaged or loose power cable, or a damaged socket outlet.
- Do not use any power cords other than the one supplied with this unit.

■ Set-up

Check that the location is suitable to bear the load of the TV. Place on a level, sturdy and horizontal base. Ensure that the unit does not hang over the edge of the base when placed in or on furniture. If placed on a cart, use caution when moving to avoid the unit from tipping over.

- Place the unit in a normal upright horizontal position. It must never be operated vertically, lying flat or hanging overhead from the ceiling.
- Place the unit where it is not exposed to direct sunlight or other sources of heat.

When mounting the TV on a wall, follow the instructions supplied with the wall-mount, make sure not to install the TV by hanging the power and signal cables on the back of the TV.

Important Safety Instructions

■ Air ventilation and high temperatures

Install your TV only where there is proper ventilation, and ensure that there is at least 10 cm free space on the sides and 20 cm above the unit for air circulation. Excessive heat and obstruction of ventilation could lead to fire or early failure of some electric components.

- Do not block any ventilation openings with newspapers, tablecloths, curtains, etc.
- Do not dry clothing etc. on top of the unit.
- Take care not to touch the ventilation openings since they may become hot.
- Do not insert foreign objects into the TV through the vents.

■ The Stand

- Do not use any stand other than the one supplied with this unit.
- Do not modify or use the stand if it becomes warped or physically damaged.
- During setup, make sure that all the screws are securely tightened.
- Ensure that the TV does not suffer any impact during the attachment of the stand.
- Ensure that children do not climb onto the stand.
- Attach or remove the stand with at least two people.

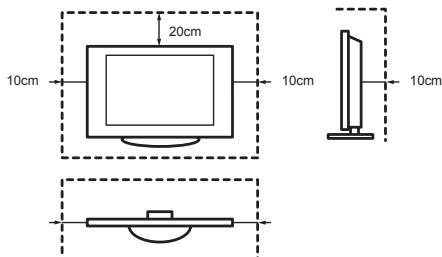

Prevent small items from getting into the interior of the device through the ventilation slots. Such objects may cause short circuits, which may cause fire.

If something should get inside the unit, immediately unplug the power plug of the device and contact service support.

■ The LED screen

Despite thorough care when manufacturing this display, it cannot be 100% guaranteed that no sub-pixel defects will occur due to technical reasons. These cannot be considered as a device defect in terms of the guarantee. They will not affect the performance and reliability of the TV.

To prevent "image burn", avoid displaying still images for long periods of time, there is a possibility that a copy of the image may remain. If the aspect ratio is set to 4:3 for a long period of time, image burn may occur on the black areas. Image burn is not covered by the warranty.

- Do not apply strong force or impact on the display panel.

Avoid touching the LED screen or touching it for long periods of time. Doing so may produce some temporary distortion effects on the screen.

■ Radio waves

- Do not use the TV in any medical institutions or locations with medical equipment. Radio waves may interfere with medical equipment and cause malfunction.
- Do not use the TV near any automatic control equipment such as automatic doors or fire alarms. Radio waves may interfere with automatic control equipment and cause malfunction.

Important Safety Instructions

If you have a cardiac pacemaker, keep a distance of at least 22 cm from the TV. Radio waves may interfere with the operation of a pacemaker.

■ Warning about off-gassing

New furniture, carpet, paint, building materials and electronics can release chemicals into the air through evaporation. After you set your TV up and turn it on for the first time, you may notice a slight smell within a couple of hours. This is because some components of TV are heating up for the first time. The materials that we use fully meet the environmental requirements and regulations. Your TV is working just fine and the fumes from the off-gassing will diminish eventually.

■ Supervision

- Do not let children play unsupervised close to the TV. It could tip over, be pushed off or pulled down from the stand surface and injure someone.
- Do not allow a switched-on TV to run unattended.

■ Volume

Loud music and noises can lead to irreversible damage to your ears. Avoid extreme volume, especially over long periods and when using headphones. If you hear a drumming noise in your ears, turn down the volume or temporarily stop using headphones.

■ Thunder Storms

Pull out the power plug and all connected antenna cables from the TV during a thunderstorm. Overvoltage caused by lightning strikes can damage the TV via the antenna system, as well as the wall socket.

■ Long periods of absence

As long as the power plug is connected to a live socket outlet, the TV will consume power even in standby mode. The power plug and all connected antenna cables should be disconnected out during long periods of absence.

■ Cleaning and care

CAUTION:

Unplug the power cord prior to cleaning the TV.

Clean the TV, the screen, and the remote control with a soft, moist, clean and color-natural cloth only. Do not use any chemicals.

- Do not subject the surfaces to insect repellent, solvent, thinner or other volatile substances. This may degrade the surface quality.
- Do not spray water or other liquids directly on the TV. Liquid inside the TV could lead to product failure.
- The surface of the display panel is treated and may be easily damaged. Take care not to scratch it with fingernails or other hard objects.
- Also wipe the power plug with a dry cloth at regular intervals.

Important Safety Instructions

■ Service/Repair

Never remove the cover/back of the TV; there are no user serviceable parts inside. Refer all service to qualified service personnel.

■ Packaging

Keep the anti-moisture materials and plastic bags out of reach of children.

Plastic bags can cause suffocation and the anti-moisture material is harmful if swallowed. If swallowed by mistake, force the patient to vomit and visit the nearest hospital.

■ Modification

Do not attempt to modify this product in any way. Unauthorized modification could void the warranty of this unit, cause electric shock and fires.

■ Remote Control batteries

- Incorrect installation may cause battery leakage, corrosion and explosion.
- Replace only with the same or equivalent type.
- Do not mix old and new batteries.
- Do not mix different battery types.
- Do not use rechargeable batteries.
- Do not burn or break up batteries.
- Be sure to dispose of batteries correctly.
- Do not expose batteries to excessive heat such as sunshine, fire or the like.

■ Outdoor Antenna Grounding

If an outdoor antenna used, be sure the antenna system is protected against voltage surges and built-up static charges.

■ Disposal

Refer to the recycling section of this manual.

Figures and illustrations in this manual are provided for reference only and may differ from actual product appearance.

Parts of the software function changes with the system upgrade.

Contents

Accessories List.....	1
Installing the Stand or Wall mount bracket.....	2
TV Front.....	4
TV Rear	5
Making Connections.....	7
Remote Control	9
Turning the TV on for the First Time.....	13
Specifications	14
Other Information.....	15

Accessories List

The following accessories are included with TV:

Quick Setup Guide × 1	Warranty Card × 1	Base Stand × 2
Remote Control × 1	AAA Battery × 2	Screw × 4
RCA jack to AV Cable × 1		

NOTE

- The accessories may be different from the list above due to different models, countries / regions, please refer to the actual accessory bag.

SIMPLIFIED EU DECLARATION OF CONFORMITY

Hereby, Hisense Visual Technology Co., Ltd. declares that the radio equipment type [32A5100F / 32A5120F / 32A5140F / 32A5160F / 32AE5000F / 32AE5010F / 32AE5030F / 32AE5050F / 40A5100F / 40A5120F / 40A5140F / 40A5160F / 40AE5000F / 40AE5010F / 40AE5030F / 40AE5050F] is in compliance with Directive 2014/53/EU. The full text of the EU declaration of conformity is available at the following internet address: <http://global.hisense.com/downloads>.

Installing the Stand or Wall mount bracket

⚠ CAUTION

- Be sure to disconnect the A/C power cord before installing a stand or wall mount brackets.
- The display on your TV is fragile. Make sure the TV screen is not scratched or damaged by hard objects or from pressure.
- After the installation is complete, make sure the TV is steady on a table or firmly attached to a wall mount, before removing all protective film, if any.

► Installing the Stand

Follow the illustrations and textual instructions below to complete the installation steps:

1. Carefully place your TV face-down on a soft, flat surface to prevent damage to the TV or scratching to the screen.
2. Remove the Base Stand from the accessory bag and then insert the stands into the bottom slots of the TV.
3. Secure the Base Stand to the TV with the screws in accessory tightly.

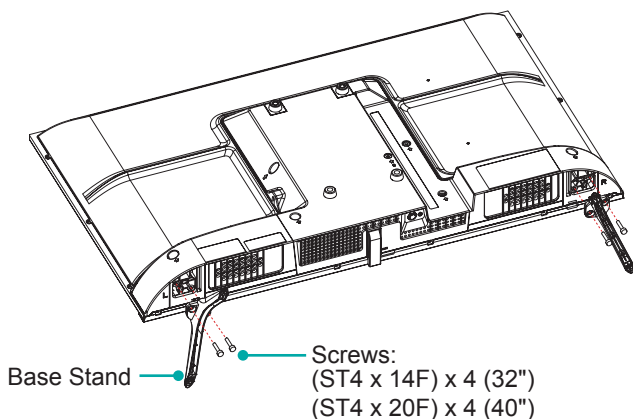

Installing the Stand or Wall mount bracket

► Installing the wall mount bracket

Before mounting the TV, remove the TV stand if you have already attached it, and make sure the wall mount bracket supports the weight of your TV.

⚠ CAUTION

When mounting the TV on a wall, follow instructions provided with the wall mount bracket. If it is not correctly mounted, the TV may fall and cause property damage or personal injury.

- Place spacers between the TV and bracket.
- Make sure the tilt angle between the TV screen and the vertical surface is no more than 15 degrees.
- Standard dimensions are shown below.

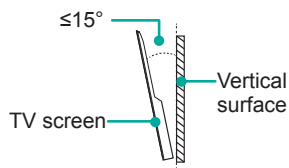

Wall mount hole pattern (mm)	100 × 200
Wall mount screw size	M6

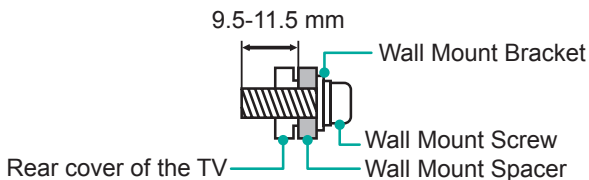

📄 NOTES

- The diameter and length of the screws differ depending on the wall mount bracket model.
- Wall mount bracket is optional. Your TV may not have wall mount bracket. Please refer to the actual accessories.

TV Front

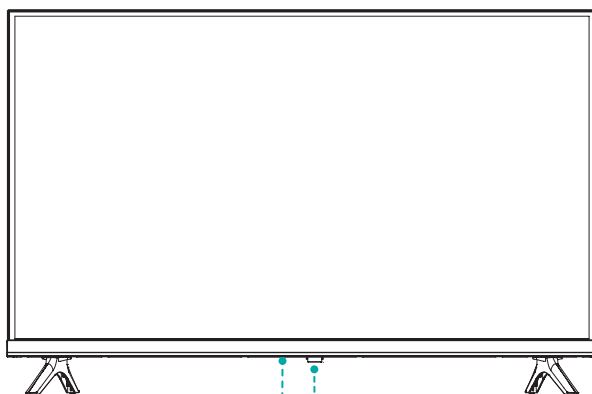

Standby / Source --- Remote sensor / Power indicator

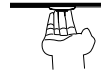
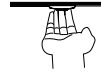
Item	Description
Remote sensor	Receive remote signals from the remote control. Do not put anything near the sensor, as its function may be affected.
Power indicator	The light is red in standby mode.
 Standby / Source ⏻ / 📶	Press the button to power on the TV. Press and hold the button to power off the TV when the focus is on “⏻”. Press the button to move the focus to “📶”, press and hold the button to select among the different input signal sources.
 VOL + / -	Press the button to move the focus to “+” or “-”, press and hold the button to adjust the volume.
 CH ^ / v	Press the button to move the focus to “^” or “v”, press and hold the button to change the channel.

NOTES

- The Picture is Only for Reference.
- Powering on the TV requires several seconds to load programs. Do not rapidly turn the TV off as it may cause the TV work abnormally.

TV Rear

TV Rear

32"

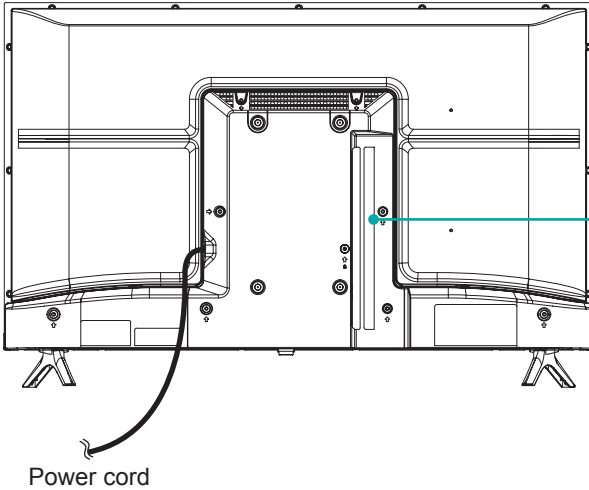

Power cord

NOTES

- ANT2 Jack supports power supply for satellite antenna (13/18V, 400mA max.)
- Check the jacks for position and type before making any connections. Loose connections can result in image or color problems. Make sure that all connections are tight and secure.
- Not all A/V devices have the ability to connect to a TV, please refer to the user's manual of your A/V device for compatibility and connections procedure.
- Before connecting external equipment, remove the mains plug from the wall socket. Otherwise, it may cause electric shock.

A vertical legend box containing icons and labels for the TV's rear panel ports. From top to bottom: a speaker icon labeled 'DIGITAL AUDIO OUT'; a headphone icon labeled 'HEADPHONE'; a card slot icon labeled 'COMMON INTERFACE(CARD FACE FRONT)'; a circular icon labeled 'AV IN'; a bracketed area containing 'ANT 1 DVB-T/T2/C' and 'ANT 2 13/18V --- 400mA DVB-S/S2'; an HDMI 1 icon labeled 'HDMI 1(ARC)'; an HDMI 2 icon labeled 'HDMI 2'; and a USB icon labeled 'USB DC 5V --- 0.5A(MAX)'. A blue line from the TV diagram points to the 'HEADPHONE' icon.

TV Rear

40"

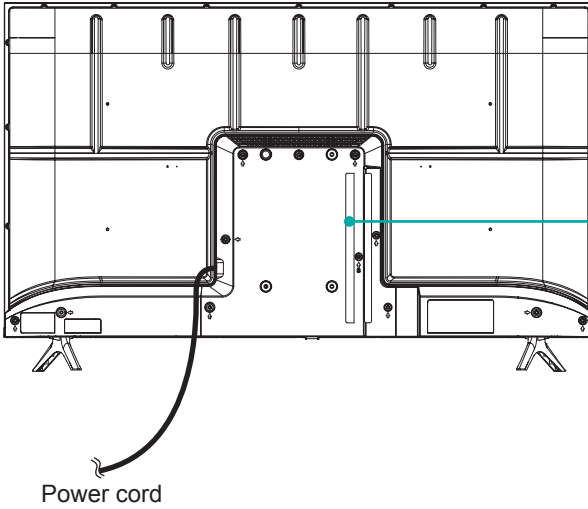



Power cord

NOTES

- ANT2 Jack supports power supply for satellite antenna (13/18V, 400mA max.)
- Check the jacks for position and type before making any connections. Loose connections can result in image or color problems. Make sure that all connections are tight and secure.
- Not all A/V devices have the ability to connect to a TV, please refer to the user's manual of your A/V device for compatibility and connections procedure.
- Before connecting external equipment, remove the mains plug from the wall socket. Otherwise, it may cause electric shock.

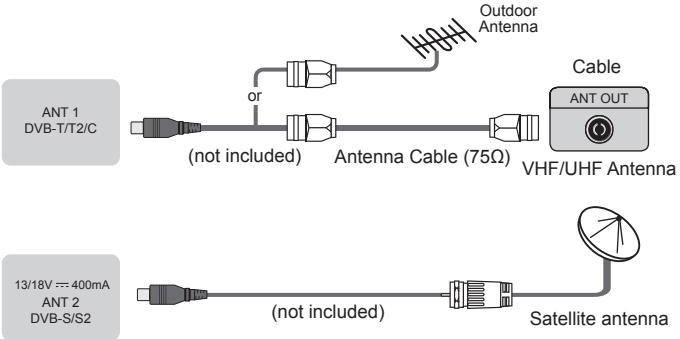
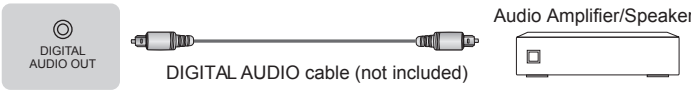
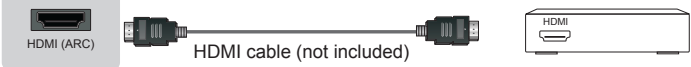
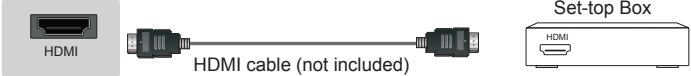
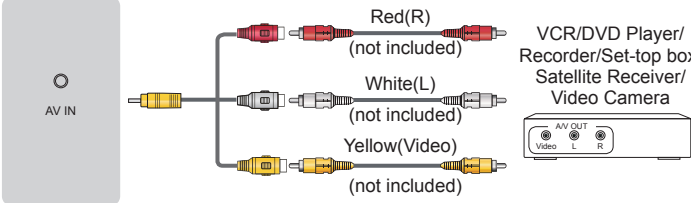

Making Connections

<p>ANT</p>		 <p>ANT 1 DVB-T/T2/C</p> <p>ANT 2 DVB-S/S2</p> <p>Outdoor Antenna</p> <p>Antenna Cable (75Ω)</p> <p>Satellite antenna</p> <p>Cable ANT OUT VHF/UHF Antenna</p> <p>(not included)</p> <p>(not included)</p> <p>13/18V \approx 400mA</p>
<p>DIGITAL AUDIO OUT</p>		 <p>DIGITAL AUDIO OUT</p> <p>DIGITAL AUDIO cable (not included)</p> <p>Audio Amplifier/Speaker</p>
<p>HDMI</p>	<p>HDMI (ARC)</p>	 <p>HDMI (ARC)</p> <p>HDMI cable (not included)</p> <p>Audio Amplifier/Speaker</p>
	<p>HDMI</p>	 <p>HDMI</p> <p>HDMI cable (not included)</p> <p>DVD/Blu-Ray/AV receiver/ Set-top Box</p>
<p>AV</p>		 <p>AV IN</p> <p>Red(R) (not included)</p> <p>White(L) (not included)</p> <p>Yellow(Video) (not included)</p> <p>VCR/DVD Player/ Recorder/Set-top box/ Satellite Receiver/ Video Camera</p>
<p>HEADPHONE</p>		 <p>HEADPHONE</p> <p>Headphone (not included)</p> <p>NOTE</p> <ul style="list-style-type: none"> Excessive sound pressure from earphones and headphones can cause hearing loss.

Making Connections

COMMON INTERFACE



NOTES

- Before you insert/remove the CI+ module, ensure that the TV is switched off. Then insert the CI card into the CI+ module in accordance with the Service Provider's instructions.
- Do not repeatedly insert or remove the Common Access Module as this may damage the interface and cause a malfunction.
- You must obtain a CI+ module and card from the service provider of the channels you want to watch.
- Insert the CI+ module with the SmartCard in the direction marked on the module and SmartCard.
- CI+ is not supported in some countries and regions; check with your authorized dealer.

USB

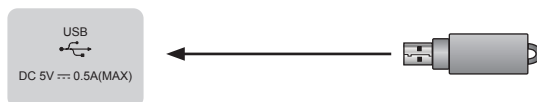

NOTES

- When connecting a hard disk or a USB hub, always connect the mains adapter of the connected device to the power supply. Exceeding a total current consumption may result in damage. The USB1.1 and USB2.0 devices maximum current consumption are 500mA.
- For individual non-standard high-capacity mobile hard disk, if its impulse current is greater than or equal 1A, it may cause TV-rebooting or self-locking. So the TV does not support it.
- The USB port supports a voltage of 5V.

Remote Control

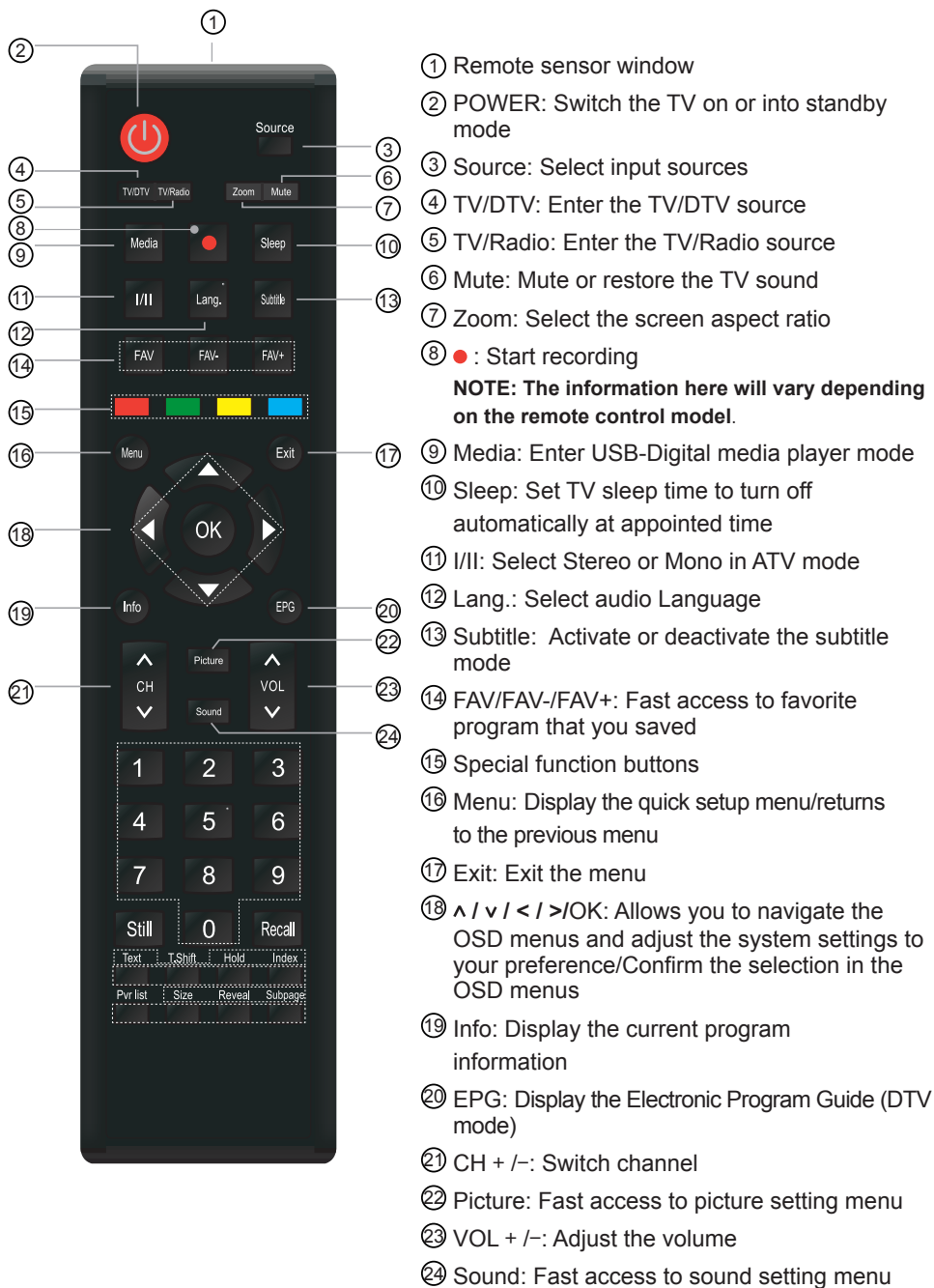

Remote Control

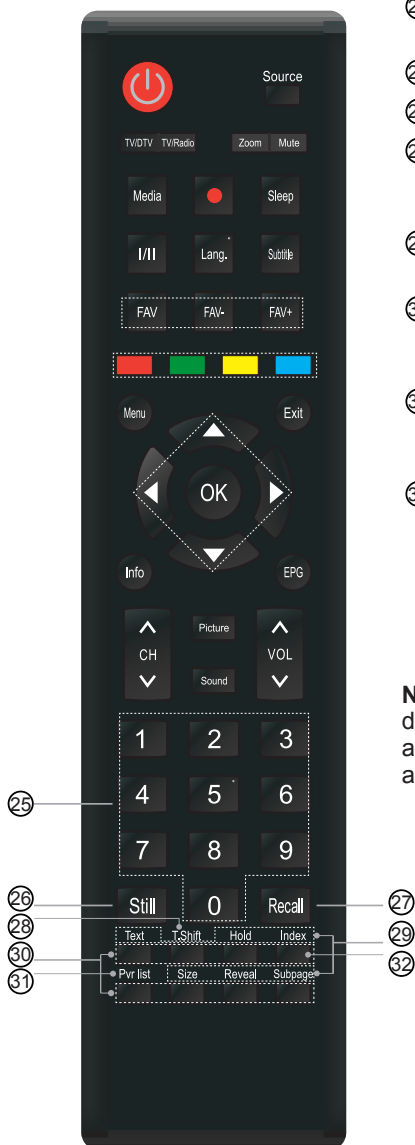

- ②5 Number button: Direct channel selection or numbers input
- ②6 Still: Freezes video
- ②7 Recall: Return to the program that last viewed
- ②8 T.Shift: Time shift in DTV mode
NOTE: The information here will vary depending on the remote control model.
- ②9 Text, Hold, Index, Size, Reveal, Subpage buttons can be used in DTV/ATV mode
- ③0 Media content control function buttons
NOTE: The information here will vary depending on the remote control model.
- ③1 Pvr list: Display video recorder list on the screen
NOTE: The information here will vary depending on the remote control model.
- ③2 (Thailand) AD: Set the audio description on or off
NOTE: The button is AD for Thailand area. The information here will vary depending on the remote control model.

NOTE: The included remote control will vary depending on model, country. Check information according to the actual remote control in the accessory bag.

Remote Control

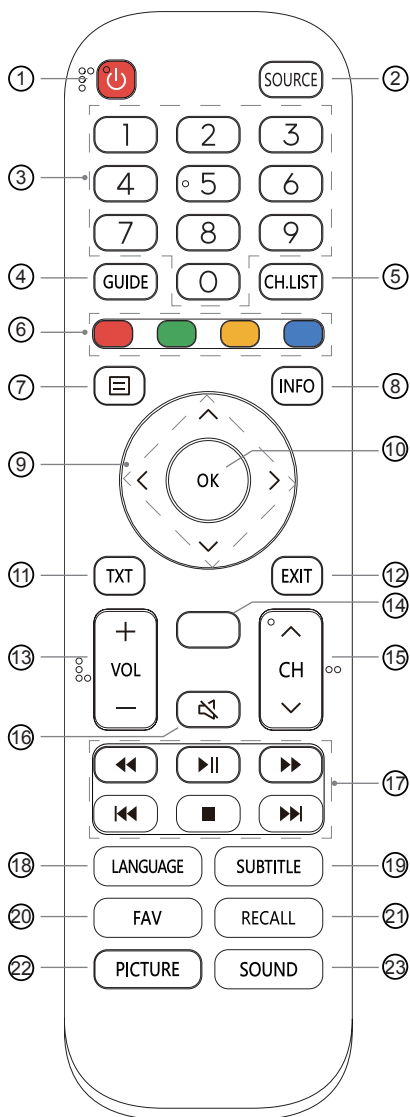

- ① POWER: Switch the TV on or into standby mode
- ② SOURCE: Select input sources
- ③ Number button: Direct channel selection or numbers input
- ④ GUIDE: Display the Electronic Program Guide (DTV mode)
- ⑤ CH.LIST: Display the Channel List on the screen
- ⑥ Special function buttons
- ⑦ : Display the quick setup menu/returns to the previous menu
- ⑧ INFO: Display the current program information
- ⑨ $\wedge / \vee / < / >$: Allows you to navigate the OSD menus and adjust the system settings to your preference
- ⑩ OK: Confirm the selection in the OSD menus
- ⑪ TXT: Turn on/off the teletext function
- ⑫ EXIT: Exit the menu
- ⑬ VOL + / -: Adjust the volume
- ⑭ **NOTE: The information here will vary depending on the remote control model.**
 - : Start recording
 - ZOOM: Select the screen aspect ratio
- ⑮ CH \wedge / \vee : Switch channel
- ⑯ MUTE: Mute or restore the TV sound
- ⑰ Media content control function buttons
- ⑱ LANGUAGE: Select audio Language/Select Stereo or Mono in ATV mode
- ⑲ SUBTITLE: Activate or deactivate the subtitle mode
- ⑳ FAV: Fast access to favorite program that you saved
- ㉑ RECALL: Return to the program that last viewed
- ㉒ PICTURE: Fast access to picture setting menu.
- ㉓ SOUND: Fast access to sound setting menu

NOTE: The included remote control will vary depending on model, country. Check information according to the actual remote control in the accessory bag.

Remote Control

▶ Installing Batteries in the Remote Control

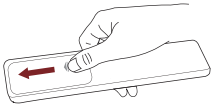

1. Slide the back cover to open the battery compartment of the remote control.

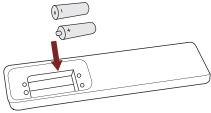

2. Insert two AAA size batteries. Make sure to match the (+) and (-) ends of the batteries with the (+) and (-) ends indicated in the battery compartment.

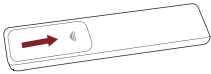

3. Close the battery compartment with the cover.

☞ NOTES

- Product image is only for reference, actual product may vary in appearance.

Handling the Batteries

- Incorrect use of batteries may cause corrosion or battery leakage, which could cause fire, personal injury or damage to property.
- Only use the battery type indicated in this manual
- Do not mix old and new batteries or different types of batteries .
- Do not dispose of used batteries as domestic waste. Dispose of them in accordance with local regulations.

▶ Remote Control Operation Range

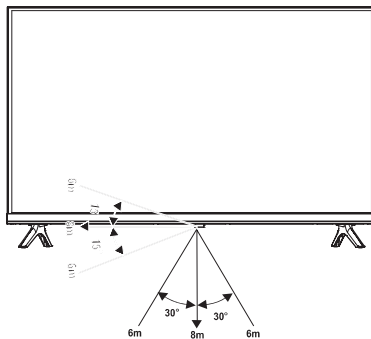

Turning the TV on for the First Time

Turning the TV on for the First Time

1. Connect the mains cable to the mains socket after you have completed all the connections.
2. The first time you turn the TV on, it will go straight into the Installation Guide.
3. Press the [**^** / **v** / **<** / **>**] buttons to navigate the menu and change the settings. Press the [**OK**] button to confirm.

Language	Select your desired language to be displayed on the menu.
Location	Using the D-pad arrows of your remote,choose your country.
Retail Mode	Choose retail mode on for shopping mall,keep retail mode off for home use.
Complete	Confirm your setting.
Tuning Setup	Set tuning mode.
Channel Tuning	Start to search program.

Specifications

☑ Features, appearance and specifications are subject to change without notice.

Item		32"	40"
Dimension (W × H × D)	Without Stand	28.2 × 16.9 × 3.4 inches (717 × 428 × 86 mm)	35.2 × 20.2 × 3.4 inches (893 × 513 × 86 mm)
	With Stand	28.2 × 18.5 × 6.3 inches (717 × 469 × 160 mm)	35.2 × 22.0 × 7.2 inches (893 × 559 × 182 mm)
Weight	Without Stand	8.4 lbs (3.8 kg)	11.9 lbs (5.4 kg)
	With Stand	8.6 lbs (3.9 kg)	12.1 lbs (5.5 kg)
Active Screen Size (Diagonal)		80 cm	100 cm
Screen resolution		1366 × 768	1920 × 1080
Operating mode power density		0.020 Watts/cm ²	0.017 Watts/cm ²
Power consumption when turned off		< 0.5 W	< 0.5 W
Power consumption in standby mode		0.5 W	0.5 W
Audio power		6W + 6W	7W + 7W
Power consumption		55 W	70 W
Power supply		AC 100-240V ~ 50/60Hz	
Receiving systems	Analog	PAL-D/K, B/G, I, SECAM-D/K, B/G	
	Digital	DVB-T/T2, DVB-C, DVB-S/S2	
Environmental conditions		Temperature: 41°F - 95°F (5°C - 35°C) Humidity: 20% - 80% RH Atmospheric pressure: 86 kPa - 106 kPa	
HDMI Input		RGB / 60 Hz (640×480, 800×600, 1024×768) YUV / 60 Hz (480 I, 480 P, 720 P, 1080 I) YUV / 50Hz (576 I, 576 P, 720 P, 1080 I)	

Recycling/Licenses

WEEE (Waste Electronic Electric Equipment)

European Directive 2012/19/EU



This symbol on the product or on its packaging indicates that this product must not be disposed of with your household waste. Instead, it is your responsibility to dispose of your waste equipment by handing it over to a designated collection point for the recycling of waste electrical and electronic equipment. The separate collection and recycling of your waste equipment at the time of disposal will help to conserve natural resources and ensure that it is recycled in a manner that protects human health and the environment. For more information about where you can drop off your waste equipment for recycling, please contact your local city office, your household waste disposal service or the shop where you purchased the product.

Batteries



In accordance with the Battery Directive, used batteries should not be disposed of in the domestic waste. Dispose your batteries in the collection containers specific for this purpose in retail stores.

ROHS (Restriction of Hazardous Substance)

European Directive 2011/65/EU



This European directive limits the use of dangerous and hazardous substances which are difficult to recycle.

This allows recycling easily the EEE and contributes to the safeguard of the environment.

Substances included in this product match to the RoHS directive.



The terms HDMI and HDMI High-Definition Multimedia Interface, and the HDMI Logo are trademarks or registered trademarks of HDMI Licensing Administrator, Inc. in the United States and other countries.



Manufactured under license from Dolby Laboratories. Dolby, Dolby Audio, Pro Logic, and the double-D symbol are trademarks of Dolby Laboratories. Confidential unpublished works. Copyright 1992-2019 Dolby Laboratories. All rights reserved.

Other Information

EPREL Registration Information

Model identifier	Eprel registration number	Model identifier	Eprel registration number
32A5100F	359247	40A5100F	358779
32A5120F	359252	40A5120F	359658
32A5140F	359633	40A5140F	359662
32A5160F	359636	40A5160F	359663
32AE5000F	359640	40AE5000F	359665
32AE5010F	359642	40AE5010F	359667
32AE5030F	359644	40AE5030F	359669
32AE5050F	359647	40AE5050F	359670

Ovaj dokument je originalno proizveden i objavljen od strane proizvođača, brenda Hisense, i preuzet je sa njihove zvanične stranice. S obzirom na ovu činjenicu, Tehnoteka ističe da ne preuzima odgovornost za tačnost, celovitost ili pouzdanost informacija, podataka, mišljenja, saveta ili izjava sadržanih u ovom dokumentu.

Napominjemo da Tehnoteka nema ovlašćenje da izvrši bilo kakve izmene ili dopune na ovom dokumentu, stoga nismo odgovorni za eventualne greške, propuste ili netačnosti koje se mogu naći unutar njega. Tehnoteka ne odgovara za štetu nanесenu korisnicima pri upotrebi netačnih podataka. Ukoliko imate dodatna pitanja o proizvodu, ljubazno vas molimo da kontaktirate direktno proizvođača kako biste dobili sve detaljne informacije.

Za najnovije informacije o ceni, dostupnim akcijama i tehničkim karakteristikama proizvoda koji se pominje u ovom dokumentu, molimo posetite našu stranicu klikom na sledeći link:

<https://tehnoteka.rs/p/hisense-televizor-32a5100f-akcija-cena/>