

Uputstvo za upotrebu (EN)

LEVOIT prečišćivač vazduha CORE P350-RAC

levoit



Tehnoteka je online destinacija za upoređivanje cena i karakteristika bele tehnike, potrošačke elektronike i IT uređaja kod trgovinskih lanaca i internet prodavnica u Srbiji. Naša stranica vam omogućava da istražite najnovije informacije, detaljne karakteristike i konkurentne cene proizvoda.

Posetite nas i uživajte u ekskluzivnom iskustvu pametne kupovine klikom na link:

<https://tehnoteka.rs/p/levoit-preciscivac-vazduha-core-p350-rac-akcija-cena/>

levoit·pet

USER MANUAL

Pet Care True HEPA Air Purifier

Model: Core P350

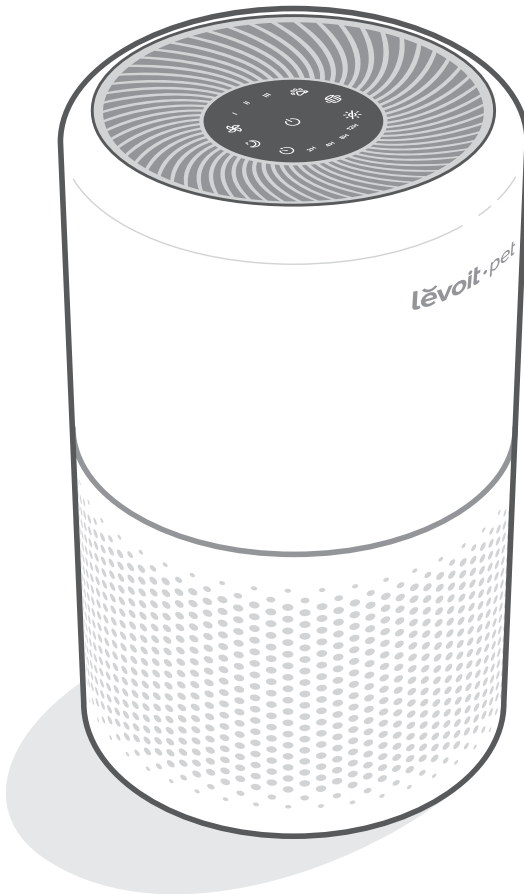

Questions or Concerns?

Please contact us Mon–Fri, 9:00 am–5:00 pm PST/PDT at support@levoit.com or at **(888) 726-8520**.

Thank you for purchasing the
**PET CARE TRUE
HEPA AIR PURIFIER
BY LEVOIT.**

If you have any questions or concerns, please reach out to us at support@levoit.com. We hope you enjoy your new air purifier!

Share the Levoit Love

Find [@LevoitLifestyle](#) on social media for wellness + style inspiration. We make every space mindful and chic.

@LevoitLifestyle
[#LevoitLove](#) • [#LevoitLifestyle](#)

Table of Contents

Package Contents	3
Specifications	3
Safety Information	4
Getting to Know Your Air Purifier	5
Controls	6
Getting Started	6
Using Your Purifier	7
About the Pet Allergy Filter	8
Care & Maintenance	10
Troubleshooting	12
Warranty Information	14
Customer Support	15

Package Contents

1 x	Pet Care True HEPA Air Purifier
1 x	True HEPA 3-Stage Pet Allergy Filter (Pre-Installed)
1 x	User Manual
1 x	Quick Start Guide

Specifications

Power Supply	AC 120V, 60Hz
Rated Power	45W
Effective Range	≤ 219 ft ² / 20 m ²
CADR (CFM)	Smoke: 141, Dust: 140, Pollen: 145
Operating Conditions	Temperature: 14°–104°F / -10°–40°C
	Humidity: < 85% RH
Noise Level	24–50dB
Standby Power	< 0.8W
Dimensions	8.7 x 8.7 x 14.2 in / 22 x 22 x 36 cm
Weight	7.5 lb / 3.4 kg

SAFETY INFORMATION

To reduce the risk of fire, electric shock, or other injury, follow all instructions and safety guidelines.

General Safety

- **Only** use your air purifier as described in this manual.
- **Do not** use without removing the plastic wrap from the filter. The purifier will not filter air, and may overheat, causing a fire hazard.
- **Do not** use your air purifier outdoors.
- Keep your air purifier away from water, and wet or damp areas. **Never** place in water or liquid.
- **Do not** use in excessively humid areas.
- Keep your air purifier away from heat sources.
- **Do not** use where combustible gases, vapors, metallic dust, aerosol (spray) products, or fumes from industrial oil are present.
- Keep 5 ft / 1.5 m away from where oxygen is being administered.
- Supervise children when they are near the air purifier.
- **Do not** place anything into any opening on the air purifier.
- **Do not** sit or place heavy objects on the air purifier.
- Keep the inside of the air purifier dry. To prevent moisture buildup, avoid placing in rooms with major temperature changes or underneath air conditioners.
- **Always** unplug your air purifier before servicing (such as changing the air filter).

- **Do not** use your air purifier if it is damaged or not working correctly, or if the cord or plug is damaged. **Do not** try to repair it yourself. Contact **Customer Support** (see page 15).
- **WARNING: Do not** use this air purifier with solid-state speed controls (such as a dimmer switch).
- Not for commercial use. Household use **only**.

Power and Cord

- Keep air purifier near the outlet it is plugged into.
- **Never** place the cord near any heat source.
- **Do not** cover the cord with a rug, carpet, or other covering. **Do not** place the cord under furniture or appliances.
- Keep the cord out of areas where people walk often. Place the cord where it will not be tripped over.
- Your air purifier has a polarized plug (one prong is wider than the other), which fits into a polarized outlet only one way. This is a safety feature to reduce the risk of electric shock. If the plug does not fit, reverse the plug. If it still does not fit, **do not** use the plug in that outlet. **Do not** bypass this safety feature.
- This air purifier uses standard US 120V, 60Hz outlets. If using in a different area, check for compatibility.

READ AND SAVE THESE INSTRUCTIONS

GETTING TO KNOW YOUR AIR PURIFIER

- A. Fan Speed Indicators
- B. Fan Speed Button
- C. Sleep Mode Indicator/Button
- D. Timer Button
- E. Timer Indicators
- F. On/Off Button
- G. Pet Lock Button
- H. Pet Lock Button
- I. Check Filter Indicator
- J. Display Off Button
- K. Air Outlet
- L. Air Inlet
- M. Power Cord
- N. Filter Cover
- O. True HEPA 3-Stage Pet Allergy Filter

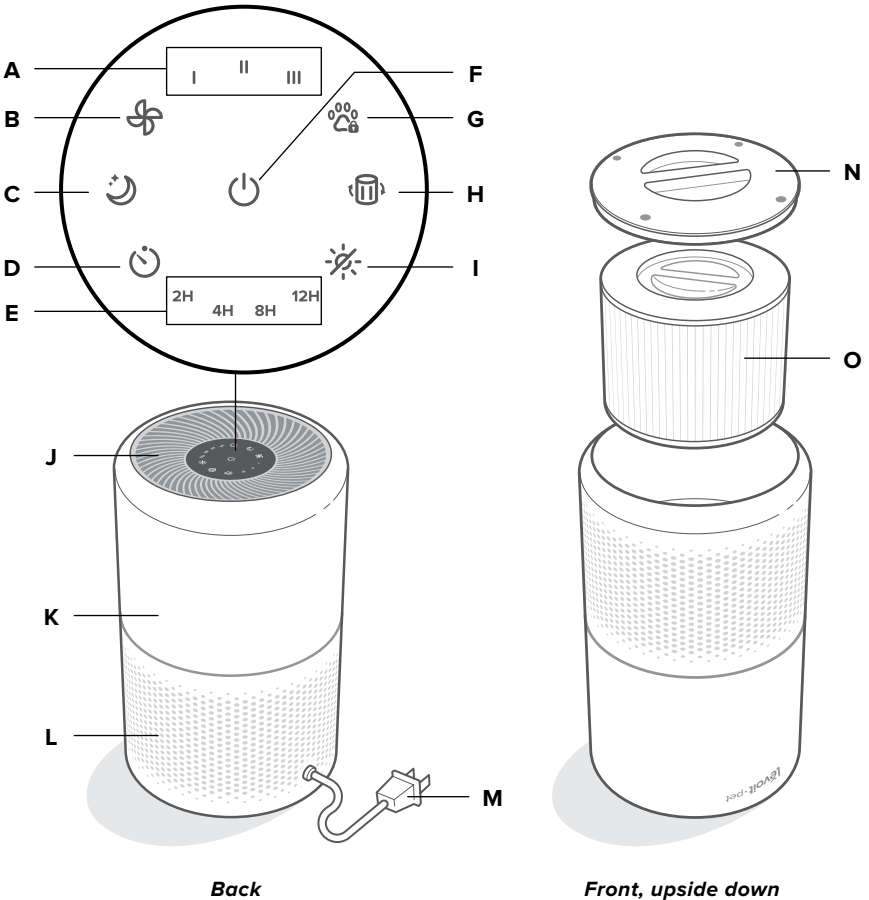

CONTROLS



On/Off Button

- Turns the air purifier on/off.



Fan Speed Button

- Cycles through fan speeds: I (low), II (medium), and III (high).



Sleep Mode Button

- Turns Sleep Mode on/off (see page 8).



Timer Button

- Cycles through timer options (see page 8).



Pet Lock Button

- Prevents current settings from being changed, such as by children or pets (see page 8).



Check Filter Indicator

- Lights up when the air filter should be checked (see **Check Filter Indicator** page 10).



Display Off Button

- Turns the display off.
- Tap any button (except ) to turn the display back on.

GETTING STARTED

1. Flip the air purifier over. Twist the filter cover counterclockwise and remove it. *[Figure 1.1]*
2. Remove the filter from its plastic packaging and place the filter back into the purifier with the handle facing up. *[Figure 1.2]*

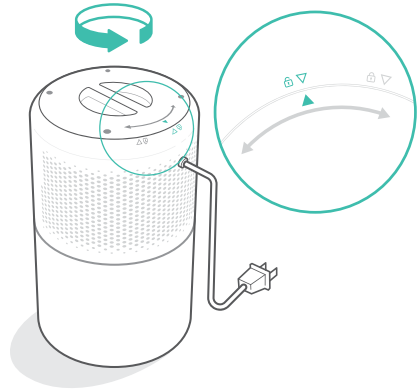

Figure 1.1

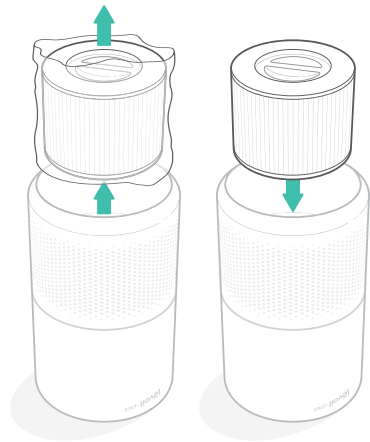

Figure 1.2

GETTING STARTED (CONT.)

3. Replace the filter cover and twist clockwise to lock. *[Figure 1.3]*
4. Place the purifier on a flat, stable surface with the display facing up. Allow at least 15 in / 38 cm of clearance on all sides of the purifier. Keep away from anything that would block air flow, such as curtains. *[Figure 1.4]*

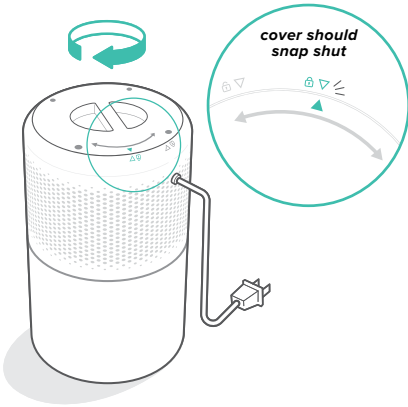

Figure 1.3

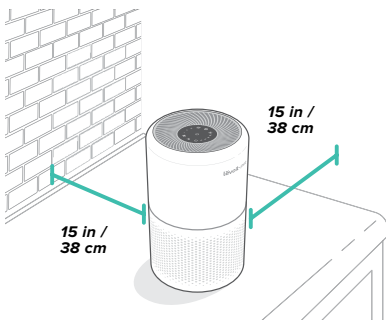





Figure 1.4

USING YOUR PURIFIER

1. Plug in and tap  to turn on the purifier. The fan will start on level I. *[Figure 2.1]*
2. Optionally, tap  to change fan speed between I, II, and III.

Note:

- The indicators are not buttons and cannot be used to change the fan speed.
- The fan speed indicators will light up when active.
- Fan speed III is the loudest, but cleans air the quickest.
- For best results, or to address a specific air quality issue such as smoke, run the air purifier at maximum speed (level III) for 15–20 minutes before using a lower speed.
- To effectively clean air, keep windows and doors closed while the air purifier is on.

3. Tap  to turn off the air purifier.

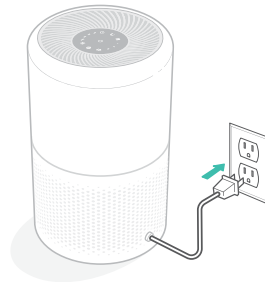

Figure 2.1

Memory Function

When the air purifier is plugged in, it will remember its previous fan speed setting.

Note: The air purifier will not remember timers or Sleep Mode.

USING YOUR PURIFIER (CONT.)

Sleep Mode

Sleep Mode operates quietly by using the lowest possible fan speed.

Tap  to turn Sleep Mode on/off.

Note:

- All indicators will be at half brightness while Sleep Mode is on.
- Tapping  will exit Sleep Mode.

Timer

You can set a timer for 2, 4, 8, or 12 hours.

1. Tap  repeatedly to select a time. The timer will start automatically.

Note:

- The indicators are not buttons and cannot be used to select a time.
- The timer indicators will light up blue when active.

2. Once the timer has finished, the air purifier will power off.
3. To cancel a timer, tap  until all timer indicators are off.

Note:

- You can change the fan speed at any time while the timer is on.
- The timer will restart if the time is changed.

Pet Lock

Locking the display prevents settings from being accidentally changed, such as by children or pets. Buttons will not respond when tapped.

1. Tap and hold  for 3 seconds to lock/unlock the display.

Note: You can turn the display on and off even if the display is locked.

ABOUT THE PET ALLERGY FILTER

The air purifier uses a 3-stage filtration system to purify air, with special customization for pet allergies and odors.

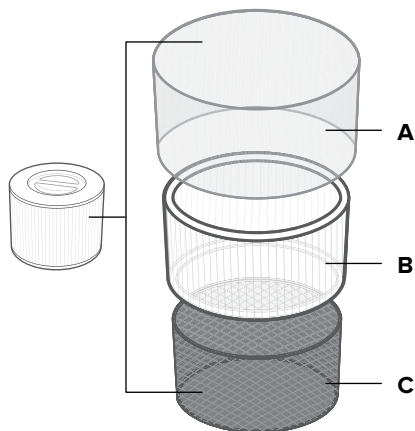

A. Fine Non-Woven Fabric Pre-Filter

- Captures large particles such as dust, lint, fibers, hair, pet fur, and pet dander.
- Maximizes the filter's life.

B. True HEPA Filter

- Removes at least 99.97% of airborne particles 0.3 micrometers (μm) in diameter.
- Filters small particles such as mold spores, tiny dust particles, parts of smoke, and allergens such as pollen, dust mites, and pet dander.

C. Custom High-Efficiency Activated Carbon Filter

- Physically adsorbs unwanted odors and fumes.
- Customized using the ARC formula to be especially effective for cooking smells and pet odors in a multi-pet household.

ABOUT THE PET ALLERGY FILTER (CONT.)

Clean Air Delivery Rate

Clean Air Delivery Rate (CADR) measures the efficiency of an air purifier by indicating the volume of clean air that an air purifier produces per minute. This is based on removal of dust, pollen, and smoke, which are the 3 most common indoor air pollutants. The higher the CADR, the more particles the air purifier will remove and the larger the area it can clean. The rating is measured at the air purifier's highest speed.

Air Change per Hour

The air change rate is how many times all of the air in a room can be purified (or "changed") by the air purifier in 1 hour. Air changes per hour are calculated on the recommended room size assuming 8 ft / 2.4 m ceilings. For smaller rooms, the air change per hour will increase. The Core P350 has an air change per hour of 5, which means it can change air 5 times at the max speed. This purifier is suggested for use in a single, closed room up to 219 ft² / 20 m².

Note: To effectively clean air, keep windows and doors closed while the air purifier is on.

Humidity

Moisture may damage the air filters. This air purifier should be used in an area with a humidity level below 85% RH. If you use the air purifier in excessively humid areas, the surface of the filter will become moldy.

Note: Water or moisture will allow mold to grow. Air purifiers cannot solve an existing mold problem, only remove mold spores and reduce odors.

Essential Oils

Do not add essential oils to the air purifier or air filter. The filter will become damaged by the oil and will eventually release an unpleasant smell. **Do not** use oil diffusers near the purifier.

CARE & MAINTENANCE

Cleaning the Air Purifier

- Unplug before cleaning.
- Wipe the outside of the air purifier with a soft, dry cloth. If necessary, wipe the housing with a damp cloth, then immediately dry.
- Vacuum the inside of the air purifier.
- **Do not** clean with abrasive chemicals or flammable cleaning agents.

When Should I Replace the Air Filter?

The filter should be replaced every 6–8 months. You may need to replace your filter sooner or later depending on how often you use your air purifier. Using your air purifier in an environment with relatively high pollution may mean you will need to replace the filter more often, even if  is off.



You may need to replace your filter if you notice:

- Increased noise when the air purifier is on
- Decreased airflow
- Unusual odors
- A visibly clogged filter

Note:

- To maintain the performance of your air purifier, **only** use official Levoit filters. To buy replacement filters, visit Levoit's online store. Go to [levoit.com](https://www.levoit.com) for more information.
- Remember to reset  after changing the filter.

Check Filter Indicator

 will light up as a reminder to check the air filter. Depending on how much you use the air purifier, the indicator should turn on within 6–8 months. You may not need to replace your filter yet, but you should check it when  turns on.

Cleaning the Air Filter

The outer pre-filter should be cleaned every 2–4 weeks to increase the efficiency and extend the life of your filter. Clean the pre-filter using a soft brush or vacuum hose to remove hair, dust, and large particles. **[Figure 3.1] Do not** clean the filter with water or other liquids.

Filter	When to Clean	When to Replace
Pre-Filter	Every 2–4 weeks	6–8 months
True HEPA & Activated Carbon Filter	Do not clean	

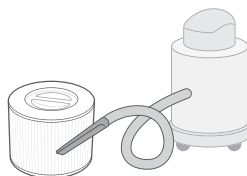









Figure 3.1

KEEPING THINGS CLEAN (CONT.)

Resetting the Check Filter Indicator

Reset the Check Filter Indicator when:

- A.  lights up.
 1. Replace the air filter.
 2. Turn on the air purifier.
 3. Press and hold  for 3 seconds.
 4.  will turn off when successfully reset.
- B. The air filter was changed before  lit up.
 1. Press and hold  for 3 seconds. This will turn on .
 2. Press and hold  again for 3 seconds.
 3.  will turn off when successfully reset.

Storage

If not using the air purifier for an extended period of time, wrap both the purifier and the filter in plastic packaging and store in a dry place to avoid moisture damage.

Replacing the Air Filter

1. Unplug the air purifier. Flip the air purifier over and remove the filter cover (see **Getting Started**, page 6).
2. Remove the old air filter.
3. Clean out any remaining dust or hair inside the purifier using a vacuum hose. **Do not** use water or liquids to clean the purifier. [Figure 3.2]
4. Unwrap the new air filter and place it into the housing (see **Getting Started**, page 6).
5. Replace the cover and cap. Plug in the air purifier.
6. Reset the Check Filter Indicator (see page 10).

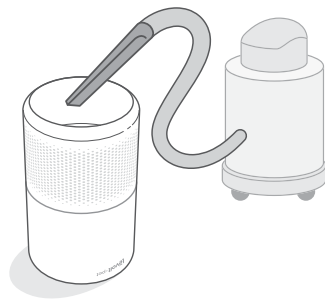











Figure 3.2

TROUBLESHOOTING

Problem	Possible Solution
Air purifier will not turn on or respond to button controls.	Plug in the air purifier.
	Check to see if the power cord is damaged. If so, stop using the air purifier and contact Customer Support (see page 15).
	Plug the air purifier into a different outlet.
	The air purifier is malfunctioning. Contact Customer Support (see page 15).
Airflow is significantly reduced.	Make sure the filter is removed from its packaging and properly in place (see page 6).
	Tap  to increase the fan speed.
	Make sure there are at least 15 in / 38 cm of clearance on all sides of the air purifier.
	The pre-filter may be clogged by large particles, such as hair or lint, blocking air flow. Clean the pre-filter (see page 10).
	Replace the air filter (see page 11).
Air purifier makes an unusual noise while the fan is on.	Make sure the air filter is properly in place with plastic packaging removed (see page 6).
	Make sure the air purifier is operating on a hard, flat, even surface.
	Replace the air filter (see page 11).
	The air purifier may be damaged, or a foreign object may be inside. Stop using the air purifier and contact Customer Support (see page 15). Do not try to repair the air purifier.
Strange smell coming from the purifier.	Clean the filter or replace if necessary.
	Contact Customer Support (see page 15).
	Make sure not to use your purifier in an area with high humidity or while diffusing essential oils.

TROUBLESHOOTING (CONT.)

Problem	Possible Solution
<p>Poor air purification quality.</p>	<p>Tap  to increase the fan speed.</p>
	<p>Make sure no objects are blocking the sides or top of the air purifier (the inlet or outlet).</p>
	<p>Make sure the filter is removed from its packaging and properly in place (see page 6).</p>
	<p>Close doors and windows while using the air purifier.</p>
	<p>Make sure the room is smaller than 219 ft² / 20 m². The air purifier may not be as effective in larger rooms.</p>
	<p>Replace the filter (see page 11).</p>
<p> is still on after replacing the air filter.</p>	<p>Reset the Check Filter Indicator (see page 11).</p>
<p> has not turned on within 8 months.</p>	<p> is a reminder for you to check the air filter and will light up based on how long the air purifier has been used (see page 11). If you don't use your air purifier often,  will take longer to turn on.</p>
<p> turned on before 6 months.</p>	<p> is a reminder for you to check the air filter and will light up based on how long the air purifier has been used (see page 11). If you run your air purifier frequently,  will turn on sooner.</p>

If your problem is not listed, please contact **Customer Support** (see page 15).

WARRANTY INFORMATION

Product Name	Pet Care True HEPA Air Purifier
Model	Core P350
Default Warranty Period	1 year
<i>For your own reference, we strongly recommend that you record your order ID and date of purchase.</i>	
Date of Purchase	
Order ID	

Arovast Corporation and its subsidiaries assume no liability for damage caused by the use of the product other than for its intended use or as instructed in the user manual. Some states do not allow this exclusion or limitation of incidental or consequential losses so the foregoing disclaimer may not apply to you. This warranty gives you specific legal rights and you may also have other rights which may vary from state to state.

ALL EXPRESSED AND IMPLIED WARRANTIES, INCLUDING THE WARRANTY OF MERCHANTABILITY, ARE LIMITED TO THE PERIOD OF THE LIMITED WARRANTY.

Terms & Policy

Arovast Corporation warrants all products to be of the highest quality in material, craftsmanship, and service, effective from the date of purchase to the end of the warranty period.

Arovast Corporation will replace any product found to be defective due to manufacturer flaws based on eligibility. Refunds are available within the first 30 days of purchase. Refunds are only available to the original purchaser of the product. This warranty extends only to personal use and does not extend to any product that has been used for commercial, rental, or any other use for which the product is not intended. There are no warranties other than the warranties expressly set forth with each product.

This warranty is non-transferrable. Arovast Corporation is not responsible in any way for any damages, losses, or inconveniences caused by equipment failure or by user negligence, abuse, or use noncompliant with the user manual or any additional safety or use warnings included in the product packaging and manual.

This warranty does not apply to the following:

- Damage due to abuse, accident, alteration, misuse, tampering, or vandalism.
- Improper or inadequate maintenance.
- Damage in return transit.
- Unsupervised use by children under 18 years of age.

Additional 1-Year Warranty

You can extend your 1-year warranty by an additional year. Log onto www.levoit.com/warranty to register your new product for the extended warranty.

Please fill out all required fields and include your order ID, place of purchase, and purchase date, if applicable.

Defective Products & Returns

If you discover your product is defective within the specified warranty period, please contact Customer Support via support@levoit.com with a copy of your invoice and order ID. **DO NOT** dispose of your product before contacting us. Once our Customer Support Team has approved your request, please return the product with a copy of the invoice and order ID.

CUSTOMER SUPPORT

If you have any questions or concerns about your new product, please contact our helpful Customer Support Team.

Arovast Corporation

1202 N. Miller St., Suite A
Anaheim, CA 92806

Email: support@levoit.com

Toll-Free: (888) 726-8520

Support Hours

Mon–Fri, 9:00 am–5:00 pm PST/PDT

*Please have your order invoice and order ID ready before contacting Customer Support.

lėvoit•pet



/LEVOITLIFESTYLE



/LEVOIT



/LEVOIT



/LEVOIT



LEVOIT.COM

Ovaj dokument je originalno proizveden i objavljen od strane proizvođača, brenda Levoit, i preuzet je sa njihove zvanične stranice. S obzirom na ovu činjenicu, Tehnoteka ističe da ne preuzima odgovornost za tačnost, celovitost ili pouzdanost informacija, podataka, mišljenja, saveta ili izjava sadržanih u ovom dokumentu.

Napominjemo da Tehnoteka nema ovlašćenje da izvrši bilo kakve izmene ili dopune na ovom dokumentu, stoga nismo odgovorni za eventualne greške, propuste ili netačnosti koje se mogu naći unutar njega. Tehnoteka ne odgovara za štetu nanесenu korisnicima pri upotrebi netačnih podataka. Ukoliko imate dodatna pitanja o proizvodu, ljubazno vas molimo da kontaktirate direktno proizvođača kako biste dobili sve detaljne informacije.

Za najnovije informacije o ceni, dostupnim akcijama i tehničkim karakteristikama proizvoda koji se pominje u ovom dokumentu, molimo posetite našu stranicu klikom na sledeći link:

<https://tehnoteka.rs/p/levoit-preciscivac-vazduha-core-p350-rac-akcija-cena/>