

Uputstvo za upotrebu

TEFAL seckalica MB8135

Tefal[®]



Tehnoteka je online destinacija za upoređivanje cena i karakteristika bele tehnike, potrošačke elektronike i IT uređaja kod trgovinskih lanaca i internet prodavnica u Srbiji. Naša stranica vam omogućava da istražite najnovije informacije, detaljne karakteristike i konkurentne cene proizvoda.

Posetite nas i uživajte u ekskluzivnom iskustvu pametne kupovine klikom na link:

<https://tehnoteka.rs/p/tefal-seckalica-mb8135-akcija-cena/>

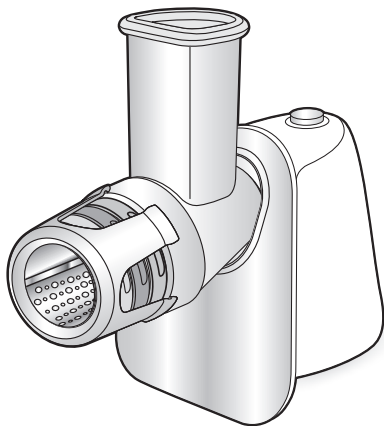

LS-123456

FR Lire attentivement le livret consignes de sécurité et ce livret avant la première utilisation. / **EN** Read safety instructions and booklet carefully before using for the first time. / **DE** Lesen Sie vor der ersten Benutzung die Sicherheitshinweise und die Broschüre sorgfältig durch. / **NL** Neem vóór het eerste gebruik dit boekje en het boekje met de veiligheidsvoorschriften aandachtig door. / **IT** Leggere con attenzione il libretto sulle norme di sicurezza e questo libretto, al primo utilizzo. / **ES** Lea detenidamente las instrucciones de seguridad y este folleto antes de utilizar el aparato por primera vez. / **PT** Leia atentamente as instruções de segurança bem como este folheto antes da primeira utilização. / **EL** Διαβάστε προσεκτικά το φυλλάδιο με τις οδηγίες ασφαλείας καθώς και αυτό το φυλλάδιο πριν χρησιμοποιήσετε τη συσκευή για πρώτη φορά. / **DA** Læs hæftet med sikkerhedsanvisninger og dette hæfte omhyggeligt, inden apparatet tages i brug første gang. / **SV** Läs häftet med säkerhetsinstruktioner och det här häftet noga innan du använder apparaten första gången. / **FI** Lue turvallisuusohjekirjanen ja tämä kirjanen huolellisesti ennen ensimmäistä käyttökertaa. / **NO** Les nøye heftet med sikkerhetsinstruksjoner og dette heftet før første gangs bruk. / **TR** İlk kullanımdan önce güvenlik talimatlarını ve kitapçığı dikkatlice okuyunuz. / **RU** Перед первым использованием прибора внимательно ознакомьтесь с правилами техники безопасности и данной инструкцией. / **UK** Прочитайте інструкції з техніки безпеки і цю брошуру першим використанням приладу. / **KK** Бірінші рет қолданар алдында қауіпсіздік жөніндегі ережелер мен осы нұсқаулықты мұқият оқып шығыңыз. / **RO** Citiți cu atenție manualul cu instrucțiunile de siguranță și această broșură înainte de prima utilizare. / **SL** Pred prvo uporabo natančno preberite navodila za varno uporabo in ta navodila. / **SR** Pre prve upotrebe pažljivo pročitajte knjižicu s bezbednosnim uputstvima i ovu knjižicu. / **HR** Molimo da prije prve uporabe pažljivo pročitate sigurnosne upute i upute za uporabu. / **BS** Prije prve upotrebe pročitate knjižicu sa sigurnosna uputstva i knjižicu o upotrebi. / **BG** Прочетете внимателно книжката и съветете за безопасност в нея преди първата употреба. / **ET** Lugege enne esimest kasutuskorda tähelepanelikult ohutusnõudeid ja seda brošüüri. / **LV** Pirms pirmās lietošanas uzmanīgi izlasiet drošības norādījumus un šo informāciju. / **LT** Prieš naudodami prietaisą pirmą kartą įdėmiai perskaitykite saugos instrukciją ir šią instrukciją. / **PL** Przed pierwszym korzystaniem z urządzenia przeczytaj uważnie książkę z zasadami bezpieczeństwa oraz niniejszą instrukcję. / **CS** Před prvním použitím si pozorně přečtěte brožuru s bezpečnostními pokyny a tuto brožuru. / **SK** Pred prvým použitím si pozorne prečítajte brožúru „Bezpečnostné odporúčania a použitie“. / **HU** Az első használat előtt figyelmesen olvassa el a biztonsági előírásokat és a jelen brosúrát. / **TH** อ่านคำแนะนำเพื่อความปลอดภัยและคู่มือการใช้งานอย่างละเอียดก่อนการใช้งานเป็นครั้งแรก / **KO** 처음 사용 전 안전 지침과 현 책자를 잘 읽어 두시기 바랍니다. / **VI** VI: yọc s tay h ớng dãn an toàn v cu n s tay n y tr ớc khi sử dụng. / **ZH** 使用前，請仔細閱讀安全連繫手冊和說明書。 / **MS** Sila baca buku arahan keselamatan dan buku ini sebelum penggunaan untuk kali pertama. / **AR** قبل از استفاده دفترچه راهنمای ایمنی و این دفترچه را مطالعه کنید. / **FA** اقرار کتاب تعلیمات الامان بغنایه قبل اول استخدام.

Fresh Express

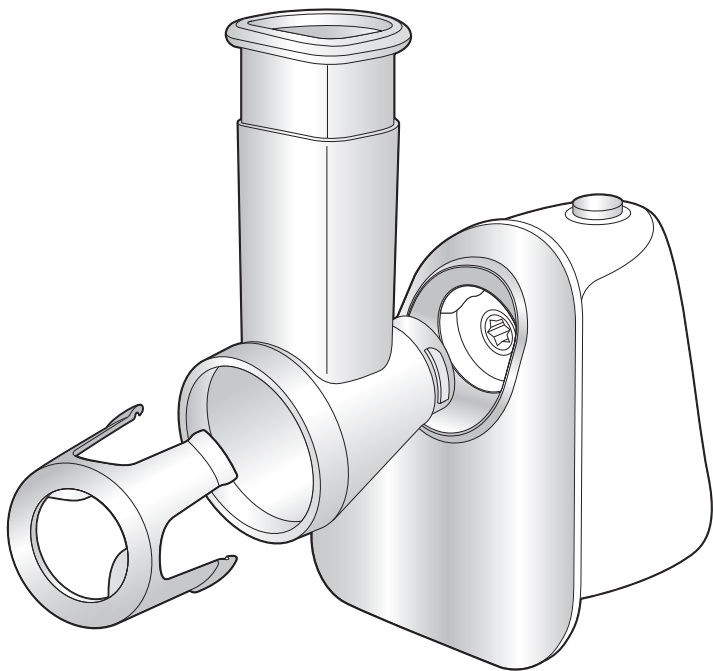

*

Selon modèle / Depending on model / Je nach Modell / Afhankelijk van het model / Secondo il modello/En función del modelo / Consoante o modelo/ανάλογα με το μοντέλο / Afhængig af model / Beroende på modell / Mallista riipruen/Avhengig av modell / Modele bağlı olarak/в зависимости от модели / залежно від моделі/үлгіге байланысты / În funcție de model/Glede na model / U zavisnosti od modela/Ovisno o modelu / Ovisno o modelu / В зависимости от модели/Söltuvalt mudelist / Atbilstoši modelim/Priklausomai nuo modelio / W zależności od modelu/Podle modelu / Podľa modelu/Modelltöl függően /แตกต่างกันไปในแต่ละรุ่น / 모델에 따라 다름 / Tùy theo mẫu / 視乎型號而定 : / Bergantung pada model / حسب النموذج / برحسب مدل



E1a*



E1b*



E2*

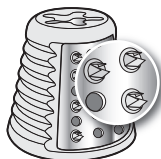

E3*



E4*

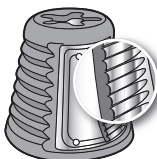

E5*

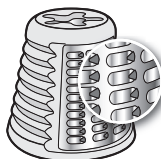

E6*



E7*

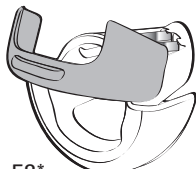

E8*

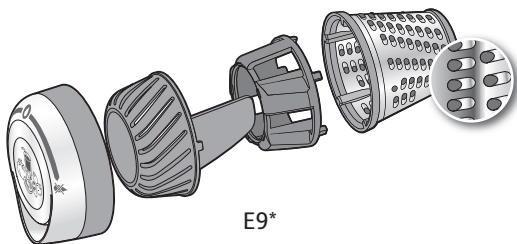

E9*

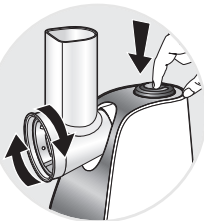
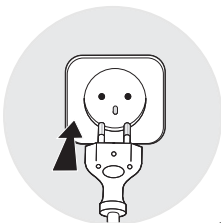
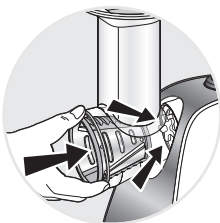
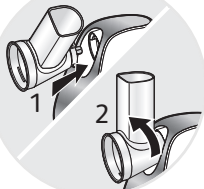
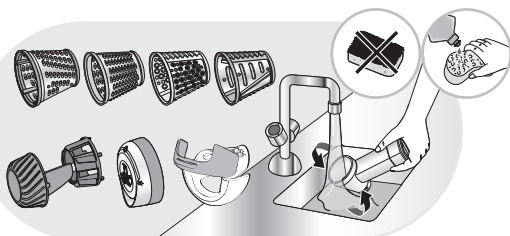

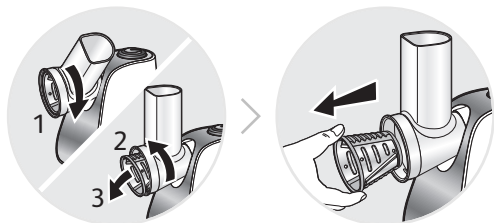

E8*





E9*

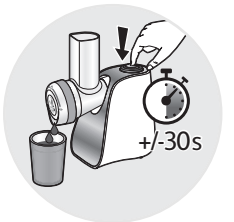
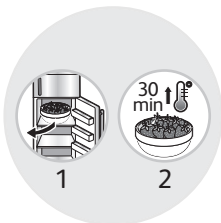
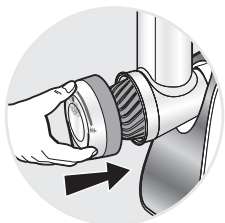
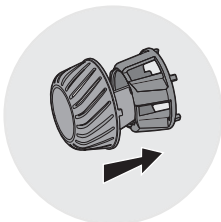
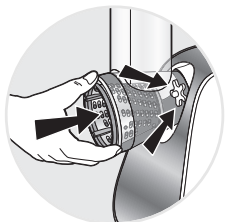





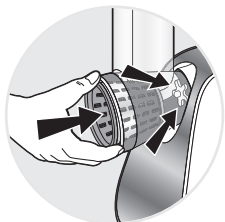

E7*



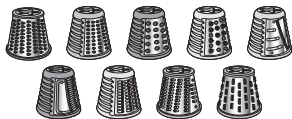
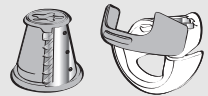
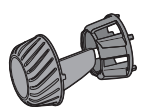

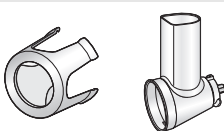
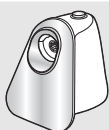
			
	✓	✓	✓
	✓	✓	✓
	✓	✓	✓
	✓	✗	✓
	✓	✓	✓
	✗	✗	✓



*



*



*



1



1

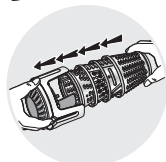

1

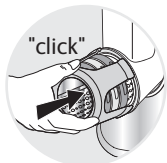

2

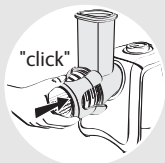

2



2

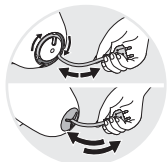

3

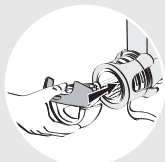

3



3



4



4



5

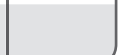
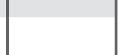
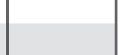
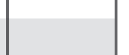
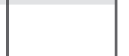
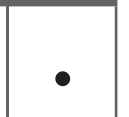
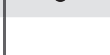
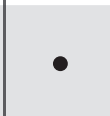
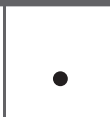
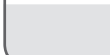
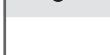
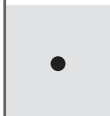
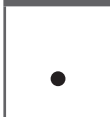
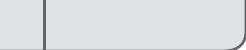
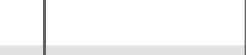
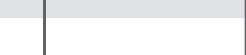
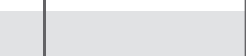
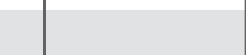
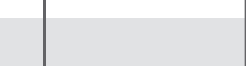

500g

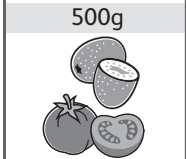

250g

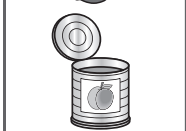

!!



Процессоры электрические кухонные (мультирезки) Moulinex DJ75xxxx DJ76xxxx,
DJ81xxxx

Изготовлено во Франции для холдинга "GROUPE SEB", France
(Groupe SEB, Chemin du Petit Bois Les 4 M - BP 172 69134 Ecully Cedex France)
Груп СЕБ, Шмэн дю Пти Буа Ле 4 М – БП 17269134 Экули Седекс Франс
Официальный представитель, импортер - ЗАО "Группа СЕБ-Восток"
125171, г. Москва, Ленинградское ш., д. 16А, стр. 3 тел. 213-32-32

Соответствуют требованиям:

- ТР ТС 004/2011 "О безопасности низковольтного оборудования", утв. Решением КТС от 16.08.2011г. №768.
- ТР ТС 020/2011 "Электромагнитная совместимость технических средств", утв. Решением КТС от 09.12.2011г. №879.

Срок службы изделия 2 года с даты продажи.



Ovaj dokument je originalno proizveden i objavljen od strane proizvođača, brenda Tefal, i preuzet je sa njihove zvanične stranice. S obzirom na ovu činjenicu, Tehnoteka ističe da ne preuzima odgovornost za tačnost, celovitost ili pouzdanost informacija, podataka, mišljenja, saveta ili izjava sadržanih u ovom dokumentu.

Napominjemo da Tehnoteka nema ovlašćenje da izvrši bilo kakve izmene ili dopune na ovom dokumentu, stoga nismo odgovorni za eventualne greške, propuste ili netačnosti koje se mogu naći unutar njega. Tehnoteka ne odgovara za štetu nanесenu korisnicima pri upotrebi netačnih podataka. Ukoliko imate dodatna pitanja o proizvodu, ljubazno vas molimo da kontaktirate direktno proizvođača kako biste dobili sve detaljne informacije.

Za najnovije informacije o ceni, dostupnim akcijama i tehničkim karakteristikama proizvoda koji se pominje u ovom dokumentu, molimo posetite našu stranicu klikom na sledeći link:

<https://tehnoteka.rs/p/tefal-seckalica-mb8135-akcija-cena/>