

Uputstvo za upotrebu

TEFAL pegla FV1542

Tefal[®]



Tehnoteka je online destinacija za upoređivanje cena i karakteristika bele tehnike, potrošačke elektronike i IT uređaja kod trgovinskih lanaca i internet prodavnica u Srbiji. Naša stranica vam omogućava da istražite najnovije informacije, detaljne karakteristike i konkurentne cene proizvoda.

Posetite nas i uživajte u ekskluzivnom iskustvu pametne kupovine klikom na link:

<https://tehnoteka.rs/p/tefal-pegla-fv1542-akcija-cena/>

FR Guide de l'utilisateur	CS Návod k použití	LV Lietošanas pamācība
EN User's guide	SK Používateľská príručka	BG Ръководство на потребителя
DE Bedienungsanleitung	PL Instrukcja obsługi	AR دليل الإستعمال
NL Gebruiksaanwijzing	CS Návod k použití	KO 사용자 가이드
ES Guía del usuario	SK Používateľská príručka	BA Korisnička uputstva
PT Guia del usuario	HU Használati útmutató	RC 使用指南
IT Manuale d'uso	SL Navodila za uporabnika	HK 使用指南
DA Brugsvejledning	RU Руководство пользователя	FA راهنمای کاربر
NO Bruksanvisning	UK Посібник користувача	VN Hướng dẫn dùng cho người sử dụng.
SV Användarhandbok	HR Upute za uporabu	TH คู่มือสำหรับผู้ใช้งาน
FI Käyttöopas	RO Ghidul utilizatorului	SR Uputstvo za upotrebu
TR Kullanım kılavuzu	ET Kasutusjuhend	
EL Οδηγός χρήσης	LT Naudotojų vadovas	
PL Instrukcja obsługi		



FR Pour plus d'informations sur l'utilisation / **EN** For further usage information / **DE** Weitere Informationen zur Bedienung / **NL** Voor meer informatie over het gebruik / **ES** Para obtener más información sobre su uso / **PT** Para obter mais informações sobre a utilização / **IT** Per maggiori informazioni sull'utilizzo / **DA** Yderligere informationer vedrørende betjening / **NO** For mer informasjon om bruken / **SV** För mer information om användningen / **FI** Lisätietoja käyttöä varten / **TR** Kullanım hakkında daha fazla bilgi için / **EL** Για περισσότερες πληροφορίες σχετικά με τη χρήση / **PL** Więcej informacji na temat korzystania z urządzenia / **CS** Pro více informací o použití / **SK** Pre ďalšie informácie o používaní / **HU** A használatra vonatkozó további információk / **SL** Več informacij o uporabi / **RU** Для получения более подробной информации об эксплуатации / **UK** Для отримання детальнішої інформації щодо експлуатації / **HR** Za više informacija o upotrebi / **RO** Pentru mai multe informații privind utilizarea / **ET** Täiendava teabe saamiseks kasutamise kohta / **LT** Daugiau informacijos apie naudojimą / **LV** Lai iegūtu vairāk informācijas par lietošanu / **BG** За още информация относно употребата / **AR** للمزيد من المعلومات عن الإستعمال / **KO** 더 자세한 사용 정보: / **BA** Za više informacija o upotrebi: / **RC** 更多关于使用的信息: / **HK** 更多關於使用的資訊: / **FA** برای کسب اطلاعات بیشتر برای استفاده / **VN** Để biết thêm thông tin về cách sử dụng: / **TH** สำหรับข้อมูลเพิ่มเติมเกี่ยวกับการใช้งาน: / **SR** Za dodatne informacije o korišćenju

www.tefal.com  www.calor.fr

ACCESS

FR Veuillez lire attentivement le livret "Consignes de sécurité et d'utilisation" avant la première utilisation / **EN** Please read carefully the "Safety and use instructions" booklet before first use / **DE** Lesen Sie vor dem erstmaligen Gebrauch aufmerksam die Broschüre „Sicherheits- und Bedienungsanweisung“ durch. / **NL** Gelieve vóór het eerste gebruik aandachtig het boekje met de veiligheids- en gebruiksvorschriften door te nemen / **ES** Lea detenidamente el libro «Instrucciones de seguridad y de uso» antes de utilizar el aparato por primera vez / **PT** Leia atentamente o manual «Instruções de segurança e utilização» antes da primeira utilização / **IT** Leggere con attenzione il libretto «Norme di sicurezza e d'uso» al primo utilizzo / **DA** Læs hæftet «Sikkerheds- og brugsanvisning» grundigt igennem inden den første ibrugtagning. / **NO** Les nøye heftet «Råd om sikkerhet og bruk» før første gangs bruk / **SV** Var god läs häftet "Säkerhets- och användningsinstruktioner" innan den första användningen. / **FI** Lue turvallisuuks- ja käyttöohjevihko huolellisesti ennen ensimmäistä käyttökertaa. / **TR** İlk kullanımdan önce «Güvenlik ve kullanım talimatları» kitapçığını dikkatlice okuyun / **EL** Διαβάστε προσεκτικά το εγχειρίδιο «Οδηγίες ασφαλείας και χρήσης» πριν από την πρώτη χρήση / **PL** Przed pierwszym użyciem proszę uważnie przeczytać broszurę „Zalecenia dotyczące bezpieczeństwa i użytkowania” / **CS** Před prvním použitím si, prosím, pečlivě prostudujte „Bezpečnostní pokyny pro použití” / **SK** Pred prvým použitím si pozorne prečítajte „Bezpečnostné odporúčania a použitie”. / **HU** Az első használat előtt figyelmesen olvassa el a „Biztonsági előírások és használati útmutató” című fejezetet / **SL** Pred prvo uporabo natančno preberite »Navodila za varno uporabo« / **RU** Перед первым использованием внимательно прочитайте инструкцию «Меры безопасности и правила использования». / **UK** Перед першим використанням уважно прочитайте посібник «Правила техніки безпеки та рекомендації щодо використання» / **HR** Molimo da prije prve uporabe pažljivo pročitate priručnik „Sigurnosne upute” / **RO** Înainte de prima utilizare, citiți cu atenție manualul „Instrucțiuni de siguranță și de utilizare” / **ET** Palun lugege enne esimest korda kasutamist hoolikalt ohutus- ja kasutusjuhendit / **LT** Atidžiai perskaitykite knygelę „Saugos ir naudojimo reikalavimai” prieš naudodami įrenginį pirmą kartą / **LV** Pirms izmantojat ierīci pirmoreiz, lūdzu rūpīgi izlasiet brošūru «Norādījumi par drošību un lietošanu» / **BG** Моля, прочетете внимателно книжката «Препоръки за безопасност и употреба» преди първоначална употреба / **AR** قبل از اولین استفاده، لطفاً جزوه ایمنی و دستورالعمل استفاده را با دقت بخوانید / **KO** 처음 사용하기 전, 제품 사용과 관련된 «안전 수칙» 책자를 주의 깊게 읽어 주시기 바랍니다 / **BA** Molimo vas da prije prve upotrebe pročitate knjižicu «Uputstva za sigurnost i upotrebu» / **RC** 在第一次使用前請認真閱讀此“安全操作規程”手冊 / **HK** 在第一次使用前請認真閱讀此“安全操作規程”手冊 / **FA** يرجى قراءة كتيب السلامة وإرشادات الإستعمال بعناية قبل الإستعمال للمرة الأولى / **VN** Vui lòng đọc kỹ cuốn «Hướng dẫn Sử dụng và Biện pháp An toàn» trước khi sử dụng lần đầu / **TH** กรุณาอ่านหนังสือคู่มือความปลอดภัยและการใช้งานก่อนการใช้งานครั้งแรก / **SR** pažljivo pročítajte priručnik „Uputstva o bezbednosti i korišćenju” pre prve upotrebe

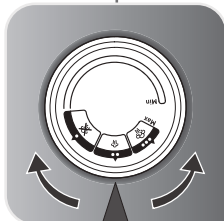
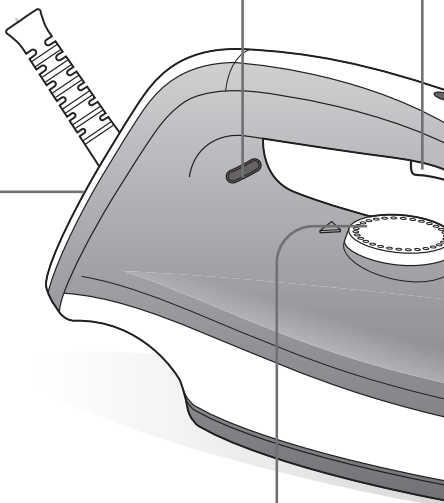
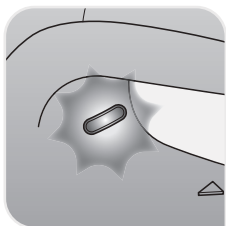

***FR** Selon modèle / **EN** Depending on model / **DE** Je nach Modell / **NL** Afhankelijk van het model / **ES** Según modelo / **PT** Consoante o modelo / **IT** Secondo i modelli / **DA** Afhængig af model / **NO** Avhenger av modell / **SV** Beroende på modell / **FI** Mallista riippuen / **TR** Modele göre / **EL** ανάλογα με το μοντέλο / **PL** W zależności od typu / **CS** Podle modelu / **SK** V závislosti od modelu / **HU** Modelltől függően / **SL** Odvisno od modela / **RU** В зависимости от модели / **UK** Залежно від моделі / **HR** Ovisno o mo delu / **RO** Ovisno o modelu / **ET** Sõltuvalt mudelist / **LT** Pagal modelį / **LV** Atbilstoši modelim / **BG** В зависимост от модела / **AR** حسب الموديل / **KO** 모델에 따라 다름 / **BA** Zavisno od modela / **RC** 視型号而定 / **HK** 視型號而定 / **FA** بسته به مدل / **VN** Theo mẫu / **TH** ตามรุ่น / **SR** U zavisnosti od modela

SAFETY
AUTO-OFF *

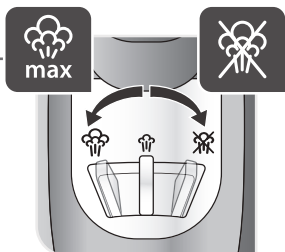
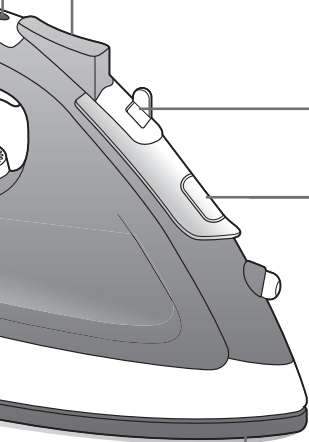
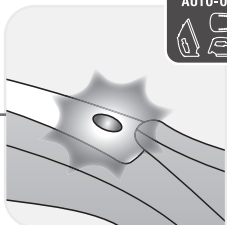

1.

www.tefal.com



www.calor.fr

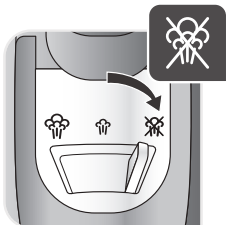

1.

www.tefal.com



www.calor.fr

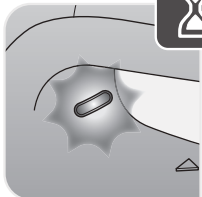
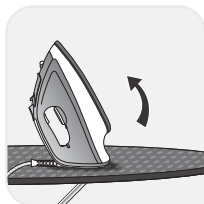
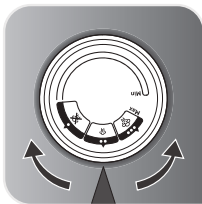
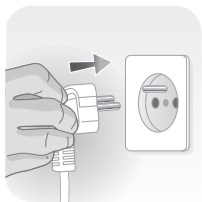

OK



OK

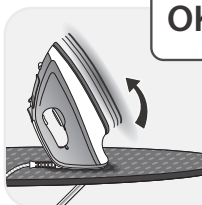

NO



2.

www.tefal.com



www.calor.fr

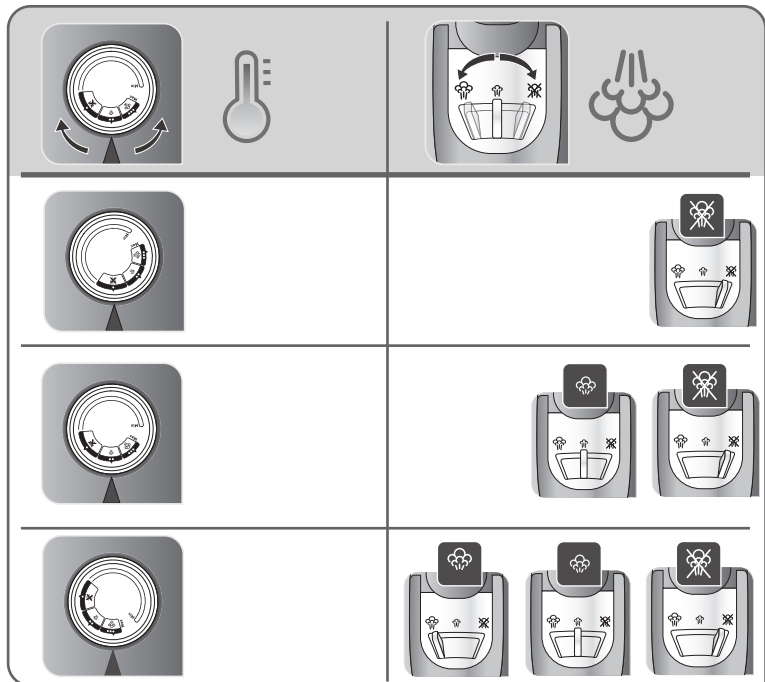

2.

www.tefal.com  www.calor.fr

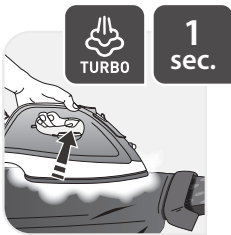
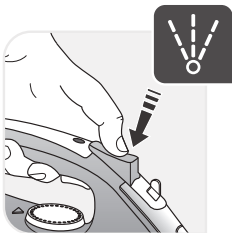

2.

www.tefal.com



www.calor.fr

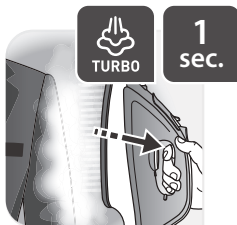
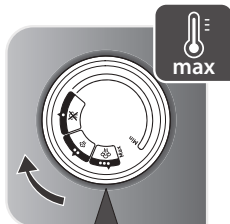
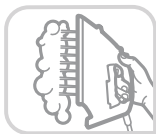

**SAFETY
AUTO-STOP**

FR Selon modèle / **EN** Depending on model / **DE** Je nach Modell / **NL** Afhankelijk van het model / **ES** Según modelo / **PT** Consoante o modelo / **IT** Secondo i modelli / **DA** Afhængig af model / **NO** Avhenger av modell / **SV** Beroende på modell / **FI** Mallista riippuen / **TR** Modele göre / **EL** ανάλογα με το μοντέλο / **PL** W zależności od typu / **CS** Podle modelu / **SK** V závislosti od modelu / **HU** Modelltől függően / **SL** Odvisno od modela / **RU** В зависимости от модели / **UK** Залежно від моделі / **HR** Ovisno o modelu / **RO** Ovisno o modelu / **ET** Sõltuvalt mudelist / **LT** Pagal modelį / **LV** Atbilstoši modeļim / **BG** в зависимост от модела / **AR** حسب الموديل / **KO** 모델에 따라 다름 / **BA** Zavisno od modela / **RC** 視型号而定 / **HK** 視型號而定 / **FA** بسته به مدل / **VN** Theo mẫu / **TH** ตามรุ่น / **SR** U zavisnosti od modela

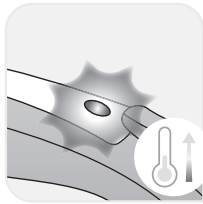
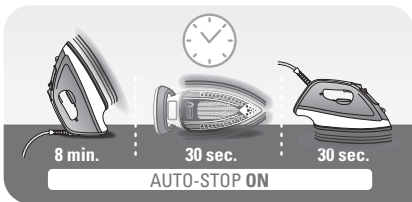
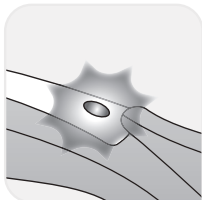
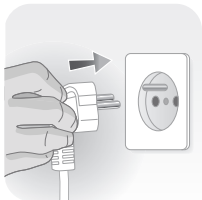

2.



www.tefal.com



www.calor.fr

**SAFETY
AUTO-STOP**



OK



3.

www.tefal.com



www.calor.fr

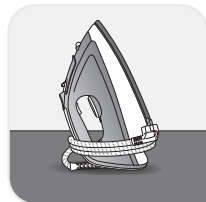
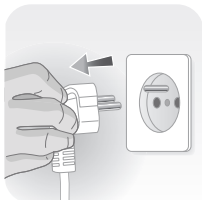
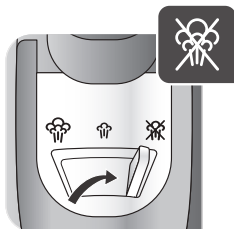

3.

www.tefal.com  www.calor.fr



1H



3.

www.tefal.com



www.calor.fr

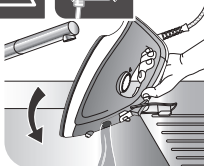

3.

www.tefal.com



www.calor.fr

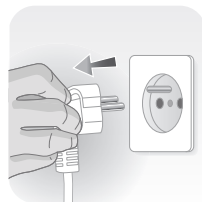
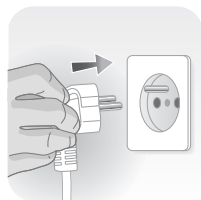

3.

www.tefal.com  www.calor.fr

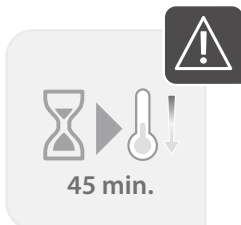
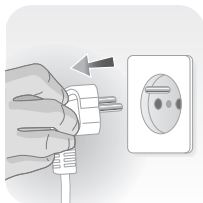
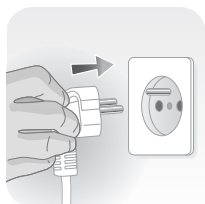

Ovaj dokument je originalno proizveden i objavljen od strane proizvođača, brenda Tefal, i preuzet je sa njihove zvanične stranice. S obzirom na ovu činjenicu, Tehnoteka ističe da ne preuzima odgovornost za tačnost, celovitost ili pouzdanost informacija, podataka, mišljenja, saveta ili izjava sadržanih u ovom dokumentu.

Napominjemo da Tehnoteka nema ovlašćenje da izvrši bilo kakve izmene ili dopune na ovom dokumentu, stoga nismo odgovorni za eventualne greške, propuste ili netačnosti koje se mogu naći unutar njega. Tehnoteka ne odgovara za štetu nanесenu korisnicima pri upotrebi netačnih podataka. Ukoliko imate dodatna pitanja o proizvodu, ljubazno vas molimo da kontaktirate direktno proizvođača kako biste dobili sve detaljne informacije.

Za najnovije informacije o ceni, dostupnim akcijama i tehničkim karakteristikama proizvoda koji se pominje u ovom dokumentu, molimo posetite našu stranicu klikom na sledeći link:

<https://tehnoteka.rs/p/tefal-pegla-fv1542-akcija-cena/>