

Uputstvo za upotrebu

TEFAL friteza FF162131

Tefal®



Tehnoteka je online destinacija za upoređivanje cena i karakteristika bele tehnike, potrošačke elektronike i IT uređaja kod trgovinskih lanaca i internet prodavnica u Srbiji. Naša stranica vam omogućava da istražite najnovije informacije, detaljne karakteristike i konkurentne cene proizvoda.

Posetite nas i uživajte u ekskluzivnom iskustvu pametne kupovine klikom na link:

<https://tehnoteka.rs/p/tefal-friteza-ff162131-akcija-cena/>

Tefal®



www.tefal.com

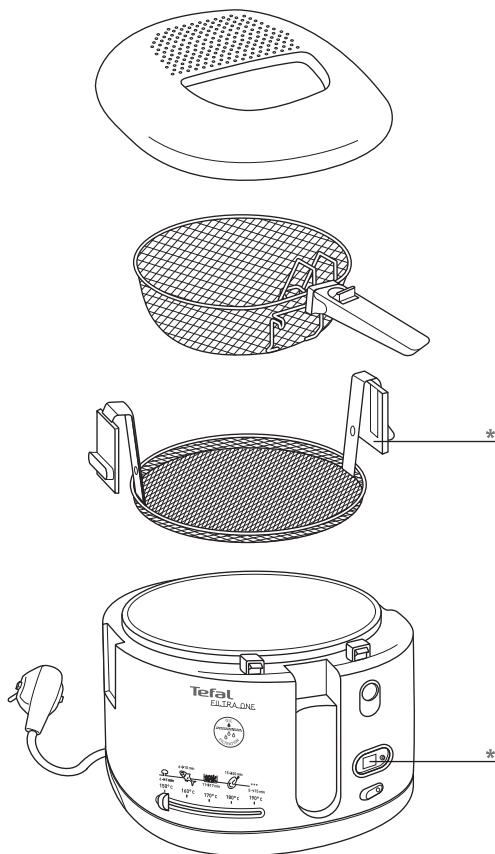

* Selon modèle • Afhankelijk van het model • Je nach Modell • Depending on model • Secondo i modelli • Según modelo • Consoante o modelo • ανάλογα με το μοντέλο • Modele göre • Áfhængig af model • Beroende på modell • Avhenger av modell • Mallista riippuen • Ovisno o modelu • Zavisno od modela • в зависимости от модели • Odvisno od modela • W zależności od typu • Podle modelu • V závislosti od modelu • Modelltól függően • В зависимости от модели • Залежно від моделі • Ovisno o modelu • Sõltuvalt mudelist • Atbilstoši modelim • Pagal modelį • بر حسب الموديل • بحسب مدل

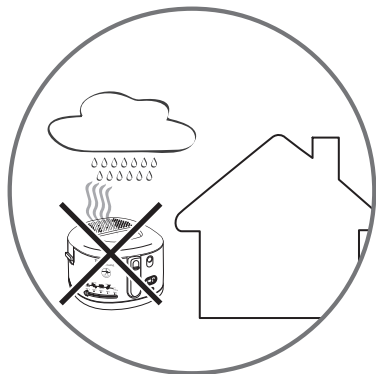

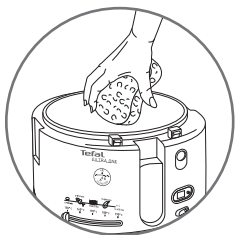
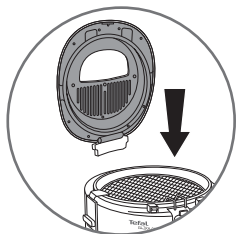
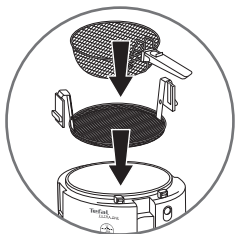
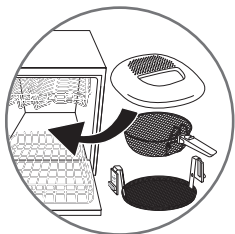
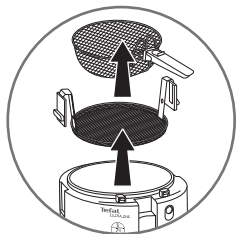
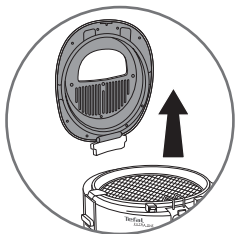



Min. 1,9 l
Max. 2,1 l

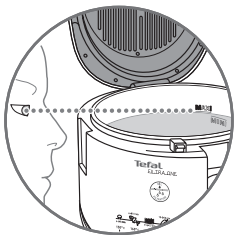
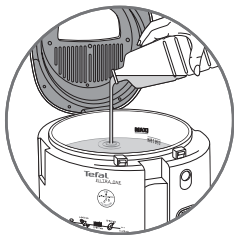

Min. 1660 g
Max. 1910 g

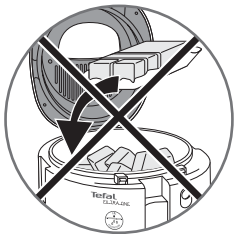
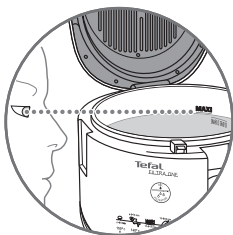
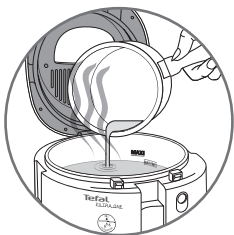
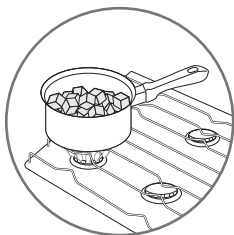



Max. 1200 g

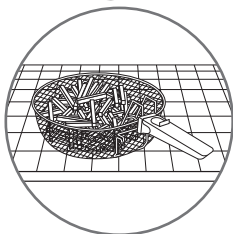
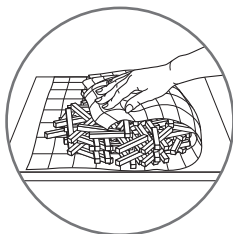

Max. 900 g

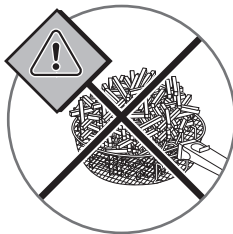
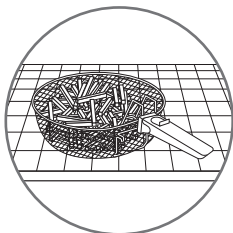
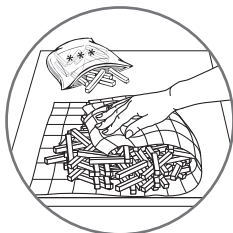

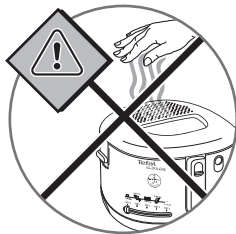
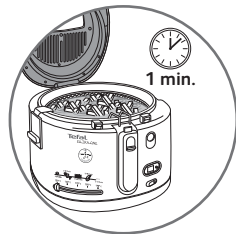
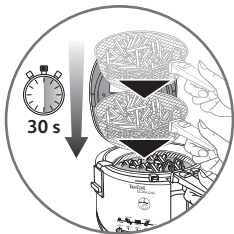
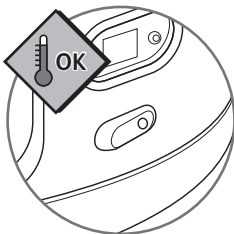
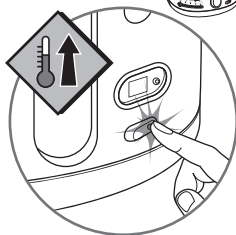
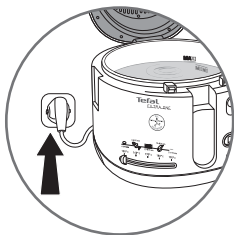

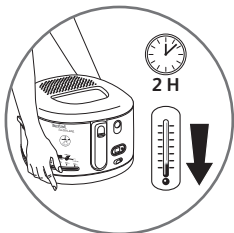
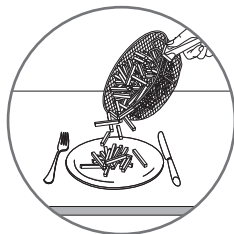
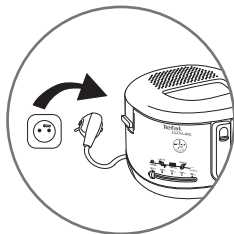
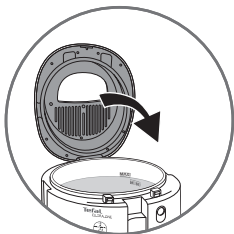
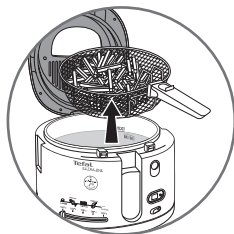
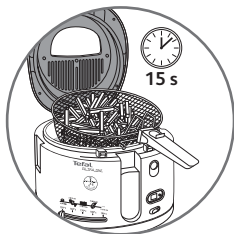
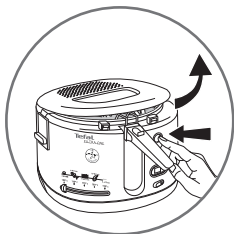
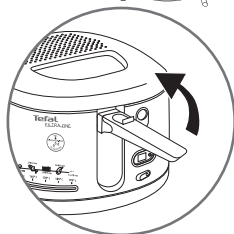
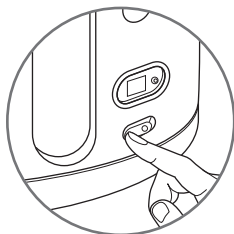
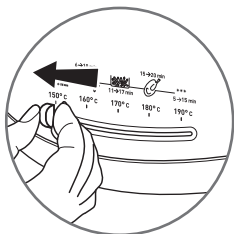

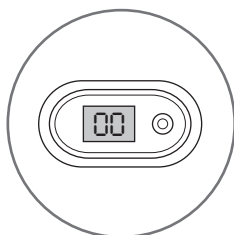
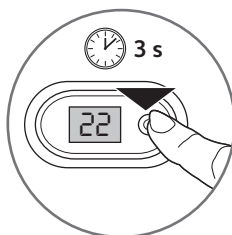
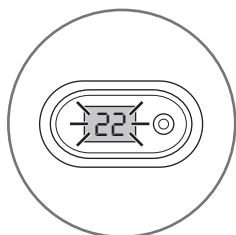
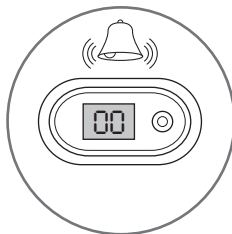
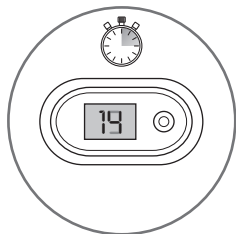
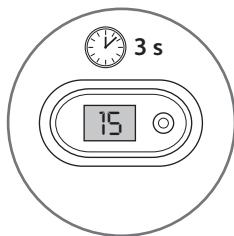
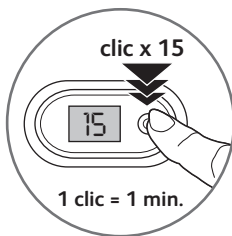
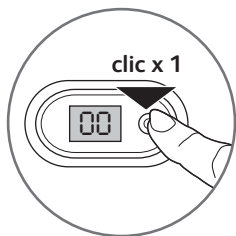























* Selon modèle • Afhankelijk van het model • Je nach Modell • Depending on model • Secondo i modelli • Según modelo • Consoante o modelo • ανάλογα με το μοντέλο • Modelle göre • Áfhængig af model • Beroende på modell • Avhenger av modell • Mallista riippuen • Ovisno o modelu • Zavisno od modela • в зависимости от модели • Odvisno od modela • W zależności od typu • Podle modelu • V závislosti od modelu • Modelltól függően • В зависимости от модели • Залежно від моделі • Ovisno o modelu • Sõltuvalt mudelist • Atbilstoši modelim • Pagal modelį • بر حسب الموديل • بر حسب مدل



	Nb			
		600 g	170°C	+/- 11-13 min
		1000 g	170°C	+/- 15-17 min
	8		180°C	+/- 13-15 min
	3		170°C	+/- 6-8 min
		200 g	150°C	+/- 8-10 min
	7-8		180°C	+/- 8-10 min
	6		180°C	+/- 6-8 min
* * *	Nb			
		750 g	190°C	+/- 8-10 min
		450 g	170°C	+/- 8-10 min
	10		190°C	+/- 6-8 min
	8		190°C	+/- 13-15 min
		900 g	190°C	+/- 7-8 min
		300 g	190°C	+/- 5-6 min

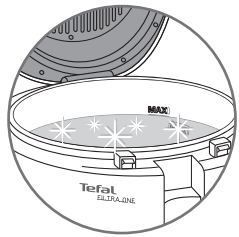
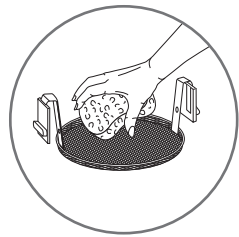
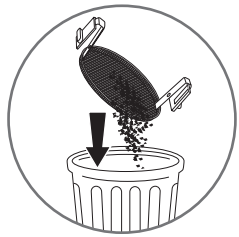
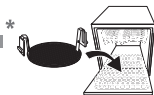

* Selon modèle • Afhankelijk van het model • Je nach Modell • Depending on model • Secondo i modelli • Según modelo • Consoante o modelo • ανάλογα με το μοντέλο • Modele göre • Afhængig af model • Beroende på modell • Avhenger av modell • Mallista riippuen • Ovisno o modelu • Zavisno od modela • в зависимости от модели • Odvisno od modela • W zależności od typu • Podle modelu • V závislosti od modelu • Modelltól függően • В зависимости от модели • Залежно від моделі • Ovisno o modelu • Sõltuvalt mudelist • Atbilstoši modelim • Pagal modelį • بر حسب المدل • حسب الموديل

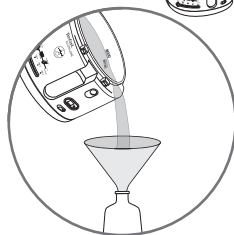
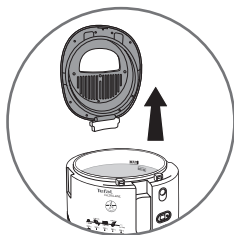

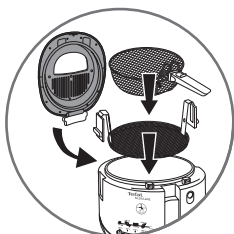
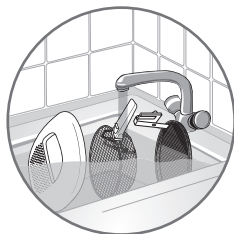
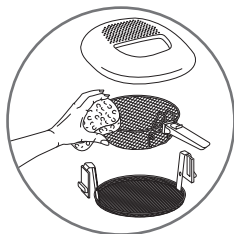
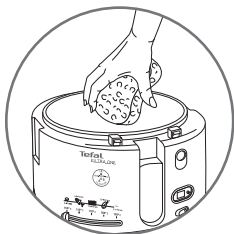
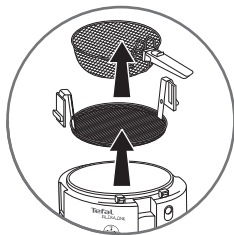
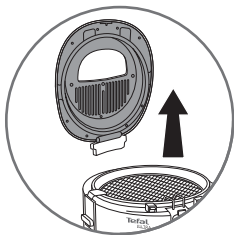

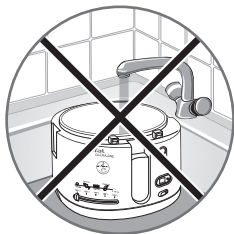

 : www.tefal.com





			
ALGERIA	GROUPE SEB EXPORT Chemin du Petit Bois, Les 4M 69130 ECULLY - FRANCE	213-41 28 18 53	1 year
ARGENTINA	GROUPE SEB ARGENTINA S.A. Billinghurst 1833 3º C1425DTK Capital Federal Buenos Aires	0800-122-2732	2 años
ՀԱՅԱՍՏԱՆ ARMENIA	«Գրուպպա ՍԵԲ-Վոստոկ»ՓԲԸ, 119180 Մոսկվա, Ռուսաստան Ստարոմոնետնի կրք., ս.14, շ.2	(010) 55-76-07	2 տարի/ years
AUSTRALIA	GROUPE SEB AUSTRALIA PO Box 7535, Silverwater NSW 2128	02 97487944	1 year
ÖSTERREICH	SEB ÖSTERREICH HmbH Campus 21 - Businesspark Wien Süd Liebermannstr. A02 702 2345 Brunn am Gebirge	01 866 70 299 00	2 Jahre
BELGIQUE / BELGIE	GROUPE SEB BELGIUM SA NV 25 avenue de l'Espérance - ZI 6220 Fleurus	32 70 23 31 59	2 ans / years
БЕЛАРУСЬ / BELARUS	ЗАО «Группа СЕБ-Восток», 119180 Москва, Россия Старомонетный пер. д.14 стр.2	017 2239290	2 года/ years
BOSNA I HERCEGOVINA	SEB Développement Predstavništvo u BiH Vrazova 8/II 71000 Sarajevo	Info-linija za potrošače 033 551 220	2 godine
BRASIL	GRUPO SEB DO BRASIL PRODUTOS DOMESTICOS LTDA Avenida Arno, 146 Mooca 03108-900 São Paulo SP	0800-119933	1 ano
БЪЛГАРИЯ/ BULGARIA	ГРУП СЕБ БЪЛГАРИЯ ЕООД Ул. Борово 52 Г, ет. 1, офис 1, 1680 София	0700 10 330	2 ГОДИНИ
CANADA	GROUPE SEB CANADA 345 Passmore Avenue Toronto, ON M1V 3N8	1-800-418-3325	1 year
CHILE	GROUPE SEB CHILE Comercial Ltda Avda. Nueva Los Leones 0252 Providencia, Santiago	+56 2 232 77 22	2 años
COLOMBIA	GROUPE SEB COLOMBIA Apartado Aereo 172, Kilometro 1 Via Zipaquira Cajica Cundinamarca	18000919288	2 años
HRVATSKA Croatia	SEB Développement S.A.S. Vodnjanska 26 10000 Zagreb	01 30 15 294	2 godine
ČESKÁ REPUBLIK / CZECH REPUBLIC	GROUPE SEB ČR spol. s r. o. Jankovcova 1569/2c 170 00 Praha 7	731 010 111	2 roky
DANMARK	GROUPE SEB NORDIC AS Tempovej 27 2750 Ballerup	44 663 155	2 år
DEUTSCHLAND	GROUPE SEB DEUTSCHLAND GmbH / KRUPS GmbH Herrrainweg 5 63067 Offenbach	0212 387 400	2 Jahre

 : www.tefal.com

			
EESTI/ ESTONIA	GRUPE SEB POLSKA SP Z O.O. ul. Ostrobramska 79 04-175 Warszawa	5 800 3777	2 aastat
SUOMI / FINLAND	Groupe SEB Finland Kutojantie 7 02630 Espoo	09 622 94 20	2 Vuotta
FRANCE Inclus Martinique, Guadeloupe, Réunion & St. Martin	GRUPE SEB France SAS Place Ambroise Courtois 69355 Lyon Cedex 08	09 74 50 47 74	1 an
GREECE / ΕΛΛΑΔΑ	SEB GROUPE ΕΛΛΑΔΟΣ Α.Ε. Οδός Φραγκοκκλησιάς 7 Τ.Κ. 151 25 Παράδεισος Αμαρουσίου	2106371251	2 χρόνια
HONG KONG	SEB ASIA Ltd. Room 901, 9/F, North Block, Skyway House 3 Sham Mong Road, Tai Kok Tsui, Kowloon	852 8130 8998	1 year
MAGYARORSZÁG/ Hungary	GRUPE SEB CENTRAL-EUROPE Kft. Tavíro köz 4 2040 Budaörs	(1) 8018434	2 év
INDONESIA	Groupe SEB Indonesia (Representative office) Sudirman Plaza, Plaza Marein 8th Floor JL Jendral Sudirman Kav 76-78, Jakarta 12910, Indonesia	+62 21 5793 6881	1 year
ITALIA	GRUPE SEB ITALIA S.p.A. Via Montefeltro, 4 20156 Milano	199207354	2 anni
JAPAN	GRUPE SEB JAPAN Co. Ltd. 1F Takanawa Muse Building, 3-14-13, Higashi Gotanda, Shinagawa-Ku, Tokyo 141-0022	0570-077772	1 year
ҚАЗАҚСТАН KAZAKHSTAN	«Группа СЕБ-Восток» ЖАҚ, 119180 Мәскеу, Ресей Старомонетный тұйық көш, 14-үй, 2-құрылыс	727 378 39 39	2 жыл / years
KOREA	(유)그림 세브 코리아 서울시 종로구 서린동 88 서린빌딩 3층 110-790	1588-1588	1 year
LATVJA / LATVIA	GRUPE SEB POLSKA SP Z O.O. ul. Ostrobramska 79 04-175 Warszawa	6 716 2007	2 gadi
LIETUVA/ LITHUANIA	GRUPE SEB POLSKA SP Z O.O. ul. Ostrobramska 79 04-175 Warszawa	6 470 8888	2 metai
MACEDONIA	Groupe SEB Bulgaria EOOD Office 1, floor 1, 52G Borovo St., 1680 Sofia - Bulgaria ГРУП СЕБ БЪЛГАРИЯ ДООЕЛ Ул. Борово 52 Г, сп. 1, офис 1, 1680 София, България	(0)2 20 50 022	2 години / years
MALAYSIA	GRUPE SEB MALAYSIA SDN. BHD Lot No.C/3A/001 & 002, Block C, Kelana Sq. No.17, Jalan SS7/26, 47301 Kelana Jaya Petaling Jaya, Selangor	65 6550 8900	1 year
MEXICO	G.S.E.B. MEXICANA, S.A. de C.V. Goldsmith 38 Desp. 401, Col. Polanco Delegacion Miguel Hidalgo 11 560 Mexico D.F.	(01800) 112 8325	1 años

			
MOLDOVA	ТОВ «Груп СЕБ Україна» Вул. Драгоманова 31 Б, офіс 1 02068 Київ, Україна	(22) 929249	2 ani / years
NEDERLAND	GROUPE SEB NEDERLAND BV Generatorstraat 6 3903 LJ Veenendaal	0318 58 24 24	2 jaar
NEW ZEALAND	GROUPE SEB NEW ZEALAND Unit E, Building 3, 195 Main Highway, Ellerslie, Auckland	0800 700 711	1 year
NORGE	GROUPE SEB NORDIC AS Tempovej 27 2750 Ballerup DANMARK	815 09 567	2 år
PERU	GROUPE SEB COLOMBIA Av. Camino Real N° 111 of. 805 B San Isidro - Lima - Perú	+511 441 4455	1 años
POLSKA/ POLAND	GROUPE SEB POLSKA SP Z O.O. ul. Ostrobramska 79 04-175 Warszawa	0801 300 422 koszt jak za połączenie lokalne	2 lata
PORTUGAL	GROUPE SEB IBÉRICA SA Urb. da Matinha Rua Projectada à Rua 3 Bloco1 - 3° B/D 1900 - 796 Lisboa	808 284 735	2 anos
REPUBLIC OF IRELAND	GROUPE SEB IRELAND Unit B3 Aerodrome Business Park, College Road, Rathcoole, Co. Dublin	01 677 4003	1 year
ROMÂNIA/ ROMANIA	GROUPE SEB ROMÂNIA Str. Daniel Constantin nr. 8 010632 Bucuresti	0 21 316 87 84	2 ani
РОССИЯ/ RUSSIA	ЗАО «Группа СЕБ-Восток», 119180 Москва, Россия Старомонетный пер. д.14 стр.2	495 213 32 37	2 года/ years
SRBIJA Serbia	SEB Developpement Antifasistické borbe 17/13 11070 Novi Beograd	060 0 732 000	2 godine
SINGAPORE	GROUPE SEB SINGAPORE Pty Ltd. 59 Jalan Pemimpin, #04-01/02 L&Y Building Singapore 577218	65 6550 8900	1 year
SLOVENSKO/ SLOVAKIA	GROUPE SEB SLOVENSKO s.r.o. Rybničná 40 831 07 Bratislava	233 595 224	2 roky
SLOVENIJA	SEB d.o.o Gregorčičeva ulica 6 2000 MARIBOR	02 234 94 90	2 leti
ESPAÑA	GROUPE SEB IBÉRICA S.A. Almogüvers, 119-123. Complejo Ecurban 08018 Barcelona	0902 31 25 00	2 años
SVERIGE	TEFAL SVERIGE SUBSIDIARY OF GROUP SEB NORDIC Truckvägen 14 A, 194 52 Upplands Väsby	08 594 213 30	2 år
SUISSE SCHWEIZ	GROUPE SEB SCHWEIZ GmbH Thurgauerstrasse 105 8152 Glattbrugg	044 837 18 40	2 ans / Jahre
TAIWAN	SEB ASIA Ltd. Taipei International Building, Suite B2, 6F-1, No. 216, Tun Hwa South Road, Sec. 2 Da-an District Taipei 106, R.O.C.	886-2-27333716	1 year

 : www.tefal.com

			
THAILAND	GROUPE SEB THAILAND 2034/66 Italthai Tower, 14th Floor, n° 14-02, New Phetchburi Road, Bangkapi, Huaykwang, Bangkok, 10320	02723 4488	2 years
TÜRKIYE	GROUPE SEB ISTANBUL AS Beybi Giz Plaza Dereboyu Cad. Meydan Sok. No: 28 K.12 Maslak	216 444 40 50	2 YIL
U.S.A.	GROUPE SEB USA 2121 Eden Road Millville, NJ 08332	800-769-3682	1 year
Україна/ UKRAINE	ТОВ «Грул СЕБ Україна» Вул. Драгоманова 31 Б, офіс 1 02068 Київ, Україна	044 492 06 59	2 роки/ years
UNITED KINGDOM	GROUPE SEB UK Ltd. 11-49 Station Road Langley, Slough Berkshire SL3 8 DR	0845 602 1454	1 year
VENEZUELA	GROUPE SEB VENEZUELA Av Eugenio Mendoza, Centro Letonia, Torre ING Bank, Piso 15, Ofc 155 Urb. La Castellana, Caracas	0800-7268724	2 anno
VIETNAM	GROUPE SEB VIETNAM (Representative office) 127-129 Nguyen Hue Street District 1, Ho Chi Minh City, Vietnam	+84-8 3821 6395	1 year

TEFAL / T-FAL INTERNATIONAL GUARANTEE

Date of purchase: / Date d'achat / Fecha de compra /
Data da compra / Data d'acquisto / Kaufdatum / Aankoopdatum / Købsdato / Inköpsdatum /
Kjøpsdato / Ostopäivä / Data zakupu / Data vânzării / Isigijimo data/ Ostukuupäev / Datum nakupa /
Sorozatszám / Dátum nákupu / Pirkuma datums / Datum Kupovine / Datum kupnje / Data
cumpărării / Datum nákupu / Tarikh pembelian / Tanggal pembelian / Ngay mua hàng/ Satin alma
taríhi / Дата продажи / Дата продаж / Дата на закупуване / Датум на купување / Сатылган
мерзімі / Ημερομηνία αγοράς/ Ψαδωνηη ορη /วันที่ซื้อ / 購買日期/購入日/구입일자/ تاریخ
خرید/ تاریخ الشراء

Product reference: / Référence du produit / Referencia del
producto / Nome do produto / tipo de prodotto / Typnummer des Gerätes / Artikelnummer van het
apparaat / Referencenummer / Produktreferens / Artikkelnnummer / Tuotenumero / referenja
produktu / Model / Gaminio numeris / Toote viitenumber / Tip aparata / Vásárlás kelte / Тип
výrobku / Produkta atsauces numurs / Model proizvoda / Oznaka proizvoda / Cod produs / Produkt
rujukan / Referensi produk / Mã sản phẩm/ Ürün kodu / Модель / Модель / Модел на уреда /
Модели / Кодικός προϊόντος / Уηηηη / รุ่นผลิตภัณฑ์ / 產品模型 / 製品レファレンス番号 / 제품명/
مرجع كامل محصول / مرجع المنتج الكامل

Retailer name & address:
/ Nom et adresse du vendeur / Nombre y direcció del minorista / Nome e endereço do revendedor
/ Nome e indirizzo delnegozio / Name und Anschrift des Händlers / Naam en adres van de dealer /
Forhandler navn & adresse / Återförsäljarens namn och adress / Forhandler navn og adresse /
Jälleenmyyjän nimi ja osoite / nazwa i adres sprzedawcy / Numele și adresa vânzătorului /
Parduotuvės pavadinimas ir adresas / Müüja kauplus ja aadress / Naziv in naslov trgovine /
Típusszám / Názov a adresa predajcu / Veikala nosaukums un adrese / Naziv i adresa maloprodaje /
Naziv i adresa prodavca / Naziv i adresa prodajnog mjesta / Nume și adresă vânzător / Název a
adresa prodejece / Nama dan alamat peruncit / Nama Toko Penjual dan alamat / Tên và địa chỉ cửa
hàng bán/ Satıcı firmanın adı ve adresi / Название и адрес продавца / Назва і адреса продавця /
Търговки обект / Назив и адреса на продавницата / Сатушының аты және мекен-жайы /
Επωνυμία και διεύθυνση καταστήματος / Ψαδωνηηη ηηηηηηηη η ηηηηηηηη η ηηηηηηηη /
ชื่อและที่อยู่ของห้าง/ร้านที่ซื้อ / 零售商的店名和地址 / 販売店の名前、住所 / 소매점 이름과 주소/
نام و آدرس خرده فروش / اسم بائع التجزئة و عنوانه

Distributor stamp / Cachet distributeur / Sello del distribuidor /
Carimbo do revendedor / Timbro del negozio / Händlerstempel / Stempel van de dealer /
Forhandler stempel / Återförsäljarens stämpel / Forhandler stempel / Jälleenmyyjän leima / pieczęć
sprzedawcy / Ștampila vânzătorului / Antspaudas / Tempel / Žig trgovine / Eladó neve, címe/
Razítko predajcu / Zīmogs / Pečat maloprodaje/ Pečat prodavca / Pečat prodajnog mjesta / Ștampila
vânzătorului/ Razítko prodejece/ Cap peruncit / Cap dari Toko Penjual / Cửa hàng bán đóng dấu/
Satıcı Firmanın Kaşesi / Печать продавца / Печатка продавця / Печат на търговския обект /
Печат на продавницата / Сатушының мөрі / Σφραγίδα καταστήματος / Ψαδωνηηη ηηηηηηηη
ตราประทับของห้าง/ร้านที่ซื้อ / 零售商的蓋印 / 販売店印 / 소매점 직인 / ختم بائع التجزئة / مهر خرده
فروش

Ovaj dokument je originalno proizveden i objavljen od strane proizvođača, brenda Tefal, i preuzet je sa njihove zvanične stranice. S obzirom na ovu činjenicu, Tehnoteka ističe da ne preuzima odgovornost za tačnost, celovitost ili pouzdanost informacija, podataka, mišljenja, saveta ili izjava sadržanih u ovom dokumentu.

Napominjemo da Tehnoteka nema ovlašćenje da izvrši bilo kakve izmene ili dopune na ovom dokumentu, stoga nismo odgovorni za eventualne greške, propuste ili netačnosti koje se mogu naći unutar njega. Tehnoteka ne odgovara za štetu nanесenu korisnicima pri upotrebi netačnih podataka. Ukoliko imate dodatna pitanja o proizvodu, ljubazno vas molimo da kontaktirate direktno proizvođača kako biste dobili sve detaljne informacije.

Za najnovije informacije o ceni, dostupnim akcijama i tehničkim karakteristikama proizvoda koji se pominje u ovom dokumentu, molimo posetite našu stranicu klikom na sledeći link:

<https://tehnoteka.rs/p/tefal-friteza-ff162131-akcija-cena/>