

Uputstvo za upotrebu

KitchenAid toster KA5KMT2115EOB

KitchenAid[®]



Tehnoteka je online destinacija za upoređivanje cena i karakteristika bele tehnike, potrošačke elektronike i IT uređaja kod trgovinskih lanaca i internet prodavnica u Srbiji. Naša stranica vam omogućava da istražite najnovije informacije, detaljne karakteristike i konkurentne cene proizvoda.

Posetite nas i uživajte u ekskluzivnom iskustvu pametne kupovine klikom na link:

<https://tehnoteka.rs/p/kitchenaid-toster-ka5kmt2115eob-akcija-cena/>

5KMT2115



KitchenAid

Table of Contents

TOASTER SAFETY

Important Safeguards.....	6
Electrical Requirements.....	8
Electrical Equipment Waste Disposal	8

PARTS AND FEATURES..... 9

USING YOUR TOASTER

Before First Use	10
Making Toast.....	11

SPECIAL TOASTING FUNCTIONS

Toasting Bagels.....	12
----------------------	----

CARING FOR YOUR TOASTER..... 12

TROUBLESHOOTING..... 13

WARRANTY AND SERVICE..... 14

Your safety and the safety of others are very important.

We have provided many important safety messages in this manual and on your appliance. Always read and obey all safety messages.



This is the safety alert symbol.

This symbol alerts you to potential hazards that can kill or hurt you and others.

All safety messages will follow the safety alert symbol and either the word "DANGER" or "WARNING." These words mean:

 **DANGER**

You can be killed or seriously injured if you don't immediately follow instructions.

 **WARNING**

You can be killed or seriously injured if you don't follow instructions.

All safety messages will tell you what the potential hazard is, tell you how to reduce the chance of injury, and tell you what can happen if the instructions are not followed.

IMPORTANT SAFEGUARDS

When using electrical appliances, basic safety precautions should always be followed, including the following:

1. Read all instructions. Misuse of appliance may result in personal injury.
2. Do not touch hot surfaces. Use handles or dials.
3. To protect against electrical shock, do not immerse cord, plugs, or Toaster in water or other liquid.
4. Close supervision is necessary when any appliance is used by or near children.
5. Unplug Toaster from outlet when not in use and before cleaning. Allow to cool before putting on or taking off parts.
6. Do not operate any appliance with a damaged cord or plug or after the appliance malfunctions or has been damaged in any manner. Return appliance to the nearest Authorised Service Centre for examination, repair, or adjustment.
7. The use of accessories not recommended by the appliance manufacturer may cause injuries.

8. Do not use outdoors.
9. Do not let cord hang over edge of table or counter, or touch hot surfaces.
10. Do not place on or near a hot gas or electric burner, or in a heated oven.
11. To disconnect, turn any control to “OFF,” then remove plug from outlet.
12. Do not use Toaster for other than intended use.
13. Oversized foods, metal foil packages, or utensils must not be inserted in Toaster as they may involve a risk of fire or electric shock.
14. A fire may occur if Toaster is covered with or touching flammable material, including curtains, draperies, walls and the like, when in operation.
15. Do not attempt to dislodge food when Toaster is plugged in.

SAVE THESE INSTRUCTIONS

This product is designed for household use only.

ELECTRICAL REQUIREMENTS

WARNING



Electrical Shock Hazard

Plug into an earthed outlet.

Do not remove earth prong.

Do not use an adapter.

Do not use an extension cord.

Failure to follow these instructions can result in death, fire, or electrical shock.

Voltage: 220-240 Volts A.C. only

Frequency: 50-60 Hz

NOTE: Your toaster has an earthed plug.

To reduce the risk of electrical shock, this plug will fit in an outlet only one way. If the plug does not fit in the outlet, contact a qualified electrician. Do not modify the plug in any way.

Do not use an extension cord. If the power supply cord is too short, have a qualified electrician or serviceman install an outlet near the appliance.

The cord should be arranged so that it will not drape over the countertop or tabletop where it can be pulled on by children or tripped over unintentionally.

ELECTRICAL EQUIPMENT WASTE DISPOSAL

Disposal of packing material

The packing material is 100% recyclable and is marked with the recycle symbol .

The various parts of the packing must therefore be disposed of responsibly and in full compliance with local authority regulations governing waste disposal.

Scrapping the product

- This appliance is marked in compliance with European Directive 2012/19/EU, Waste Electrical and Electronic Equipment (WEEE).

- By ensuring this product is disposed of correctly, you will help prevent potential negative consequences for the environment

and human health, which could otherwise be caused by inappropriate waste handling of this product.



- The symbol  on the product or on the accompanying documentation indicates that it should not be treated as domestic waste but must be taken to an appropriate collection centre for the recycling of electrical and electronic equipment.

For more detailed information about treatment, recovery and recycling of this product, please contact your local city office, your household waste disposal service or the shop where you purchased the product.

Extra-wide slots with automatic self-centering racks

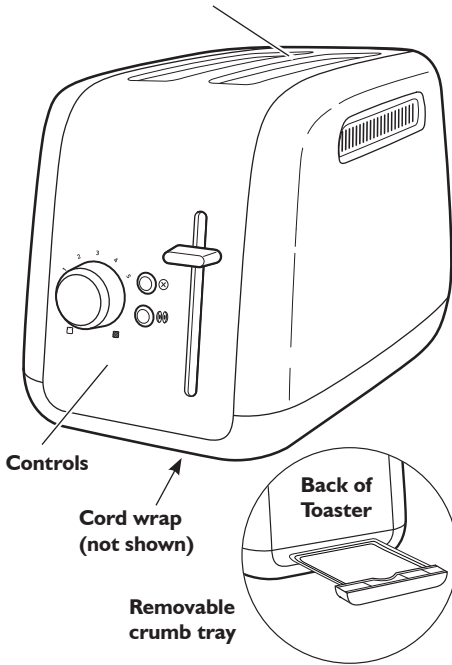

Extra-wide slots with self-centering racks

Extra-wide slots allow you to easily toast bread, bagels, and English muffins up to 2.8 cm thick. Self-centering racks help ensure even heating of thin or thick breads.

Controls

Easy-to-use controls with one-touch buttons allow you to quickly select the desired settings.

Cord wrap

The cord wrap provides convenient storage of the cord when not in use.

Removable crumb tray

The removable crumb tray slides out for quick removal of crumbs. Hand wash only.

Controls

Cord wrap
(not shown)

Removable
crumb tray

Back of
Toaster

Parts and Features

Shade Control Dial

Precisely sets the desired brownness level.

Bagel

Your Toaster features a special setting for bagels, ensuring optimal heat and time for the best results. The heating elements will adjust to nicely toast the inside of a cut bagel without burning the outside surface.

Cancel

Press the Cancel Button to stop a toasting cycle that is already in process.

High-Lift Lever

Press down to lower foods and start the toasting cycle. When toasting is complete, lever lifts food above Toaster for easy removal.

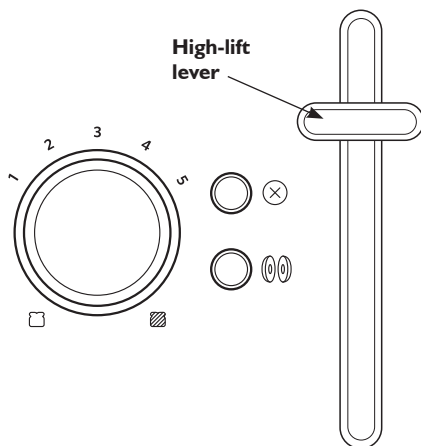

Using Your Toaster

Before First Use

Before using your Toaster, check the extra-wide slots and remove any packing or printed material that might have fallen inside during shipping or handling. Do not probe inside the Toaster with a metal object.

You may see light smoke the first time you use the Toaster. This is normal. The smoke is harmless and will soon disappear.

Using Your Toaster

Making Toast

1. Shorten cord, if necessary, by wrapping cord under the base. The toaster's feet are tall enough to allow the cord to exit from under any side of the Toaster.

⚠ WARNING



Electrical Shock Hazard

- Plug into an earthed outlet.
- Do not remove earth prong.
- Do not use an adapter.
- Do not use an extension cord.
- Failure to follow these instructions can result in death, fire, or electrical shock.

2. Plug the Toaster cord into an earthed outlet.
3. Turn the shade control dial to select the degree of brownness you want. Turn the shade control dial to the right for darker toast or to the left for lighter.
NOTE: Different types of bread and their moisture levels may require different shade settings. For example, dry bread will brown more rapidly than moist bread and will require a lighter setting.

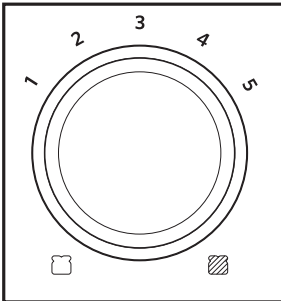

4. Insert bread or other food to be toasted in slot(s).

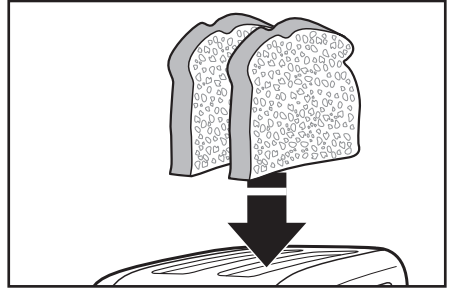

NOTE: For even toasting, toast only one bread type and thickness at a time.

If toasting bagels, be sure to press the Bagel button. See "Toasting Bagels".

5. Press down on lift lever to start the toasting cycle. The toast will rise automatically at the end of the cycle and the Toaster will turn off.

TIP: For smaller items, lift up on the lift lever to raise toast above the top of the Toaster.

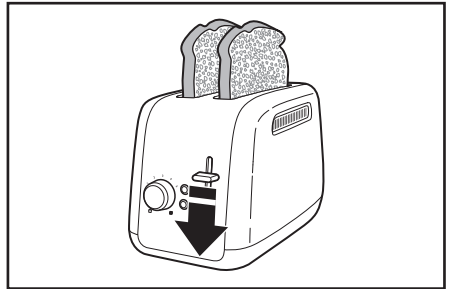

6. To cancel toasting at any time, press the Cancel button. The Toaster will raise the toast and turn off.

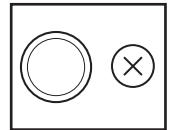

Special Toasting Functions

Toasting Bagels

Your Toaster features a special setting for bagels, ensuring optimal heat and time for the best results. The heating elements will adjust to nicely toast the inside of a cut bagel without burning the outside surface.

1. Insert bagels with the cut side facing in, as shown.

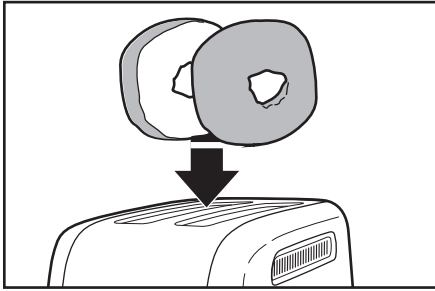

2. With the shade control dial set to the desired level of brownness, press down on the lift lever to start the toasting cycle.
3. Press the Bagel Button. The bagel(s) will rise automatically at the end of the cycle and the Toaster will turn off.

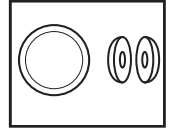

Caring for Your Toaster

1. Unplug the Toaster and let it cool before cleaning.

Grasp the centre of the crumb tray then slide it out. Shake the crumbs into a waste container. It is recommended that the crumb tray be emptied after each use. Crumb tray is hand wash only.

IMPORTANT: The tray will be hot immediately following a toasting cycle.

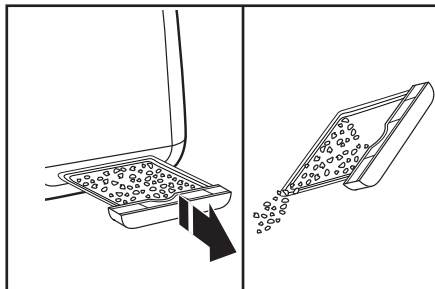

2. Wipe Toaster with a soft, damp cotton cloth. Do not use paper towels, abrasive cleansers, or liquid cleaning products. Do not immerse Toaster in water.

NOTE: If grease or oil splatters on the Toaster, wipe splatters away immediately using a clean, damp cotton cloth.

3. Return crumb tray to Toaster. Press it in firmly until it clicks into position. Do not use the Toaster without the crumb tray in proper position.

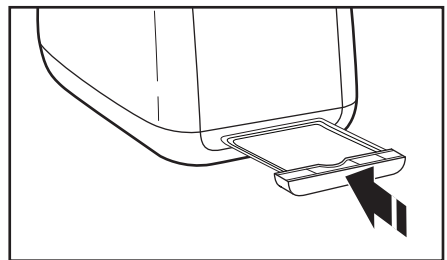

NOTE: KitchenAid does not recommend the use of a toaster cover.

⚠ WARNING



Electrical Shock Hazard

Plug into an earthed outlet.

Do not remove earth prong.

Do not use an adapter.

Do not use an extension cord.

Failure to follow these instructions can result in death, fire, or electrical shock.

If your Toaster should fail to operate, check the following:

1. Check that the Toaster is plugged into a proper electrical outlet. If it is, unplug the Toaster.
2. Plug in Toaster.

3. If the Toaster still does not work, check the household fuse or circuit breaker.

If the problem cannot be corrected:

See the "Warranty and Service" section. Do not return the Toaster to the retailer; retailers do not provide service.

Warranty and Service

KitchenAid Toaster warranty

Length of Warranty:	KitchenAid Will Pay For:	KitchenAid Will Not Pay For:
Europe, Middle East and Africa: For Model 5KMT2115: Two years Full Warranty from date of purchase.	The replacement parts and repair labour costs to correct defects in materials or workmanship. Service must be provided by an Authorised KitchenAid Service Centre.	A. Repairs when Toaster is used for operations other than normal household use. B. Damage resulting from accident, alterations, misuse, abuse, or installation/operation not in accordance with local electrical codes.

KITCHENAID DOES NOT ASSUME ANY RESPONSIBILITY FOR INDIRECT DAMAGES.

Customer service

In U.K. and Ireland:

For any questions, or to find the nearest KitchenAid Authorised Service Centre, please find our contact details below.

NOTE: All service should be handled locally by an Authorised KitchenAid Service Centre.

Contact number for U.K. and Northern Ireland:

Tollfree number 0800 988 1266 (calls from mobile phones are charged standard network rate) or call 0194 260 5504.

Contact number for Ireland:

Tollfree number +44 (0) 20 8616 5148

E-mail contact for U.K. and Ireland:

Go to www.kitchenaid.co.uk, and click on the link "Contact Us" at the bottom of the page.

Address for U.K. and Ireland:

KitchenAid Europa, Inc.
PO BOX 19
B-2018 ANTWERP 11
BELGIUM

General hotline number:



00800 3810 4026

In other countries:

For all product related questions and after sales matters, please contact your dealer to obtain the name of the nearest Authorised KitchenAid Service/Customer Centre.

For more information, visit our website at:
www.KitchenAid.co.uk
www.KitchenAid.eu

©2017 All rights reserved.

Specifications subject to change without notice.

KitchenAid

©2017 All rights reserved.
Specifications subject to change without notice.

Ovaj dokument je originalno proizveden i objavljen od strane proizvođača, brenda KitchenAid, i preuzet je sa njihove zvanične stranice. S obzirom na ovu činjenicu, Tehnoteka ističe da ne preuzima odgovornost za tačnost, celovitost ili pouzdanost informacija, podataka, mišljenja, saveta ili izjava sadržanih u ovom dokumentu.

Napominjemo da Tehnoteka nema ovlašćenje da izvrši bilo kakve izmene ili dopune na ovom dokumentu, stoga nismo odgovorni za eventualne greške, propuste ili netačnosti koje se mogu naći unutar njega. Tehnoteka ne odgovara za štetu nanесenu korisnicima pri upotrebi netačnih podataka. Ukoliko imate dodatna pitanja o proizvodu, ljubazno vas molimo da kontaktirate direktno proizvođača kako biste dobili sve detaljne informacije.

Za najnovije informacije o ceni, dostupnim akcijama i tehničkim karakteristikama proizvoda koji se pominje u ovom dokumentu, molimo posetite našu stranicu klikom na sledeći link:

<https://tehnoteka.rs/p/kitchenaid-toster-ka5kmt2115eob-akcija-cena/>