

Uputstvo za upotrebu

BEKO mašina za sušenje veša DS 8312 PX

The Beko logo is displayed in a bold, blue, sans-serif font. A thick blue horizontal line is positioned below the letters 'o' and 'k', extending from the left side of the logo towards the right.

Tehnoteka je online destinacija za upoređivanje cena i karakteristika bele tehnike, potrošačke elektronike i IT uređaja kod trgovinskih lanaca i internet prodavnica u Srbiji. Naša stranica vam omogućava da istražite najnovije informacije, detaljne karakteristike i konkurentne cene proizvoda.

Posetite nas i uživajte u ekskluzivnom iskustvu pametne kupovine klikom na link:

<https://tehnoteka.rs/p/beko-masina-za-susenje-vesa-ds-8312-px-akcija-cena/>



Dryer

User Manual

Mašina za sušenje

Priručnik za korisnika



DS 8312 PX

EN / SB

2960312834_EN/211020.1124



Please read this user manual first!

Dear Customer,
Thank you for preferring a Beko product. We hope that your product which has been manufactured with high quality and technology will give you the best results. We advise you to read through this manual and the other accompanying documentation carefully before using your product and keep it for future reference. If you transfer the product to someone else, give its manual as well. Pay attention to all details and warnings specified in the user manual and follow the instructions given therein.
Use this user manual for the model indicated on the cover page.



- Read the instructions.

Explanation of symbols

Throughout this user manual the following symbols are used:



DANGER!

- Warning against electric shock.



DANGER!

- Warning against fire hazard.



WARNING!

- Warning for hazardous situations with regard to life and property.



WARNING!

- Warning against hot surfaces.



WARNING!

- Warning against scalding hazard.



NOTE

- Important information or useful hints about usage.



Packaging materials of the product are manufactured from recyclable materials in accordance with our National Environment Regulations.

Do not dispose of the packaging wastes with the domestic waste or other wastes, discard them to the dedicated collection points designated by the local authorities.



This product was manufactured using the latest technology in environmentally friendly conditions.

1 Important instructions for safety and environment



NOTE

- This section contains safety instructions that will help protect from risk of personal injury or property damage. Failure to follow these instructions shall void any warranty.

1.1 General safety



WARNING!

This appliance can be used by children aged from 8 years and above and persons with reduced physical, sensory or mental capabilities or lack of experience and knowledge if they have been given supervision or instruction concerning use of the appliance in a safe way and understand the hazards involved. Children shall not play with the appliance. Cleaning and user maintenance shall not be made by children without supervision.

Children of less than 3 years should be kept away unless continuously supervised.

- Adjustable feet should not be removed. The gap between the dryer and the floor should not be reduced with materials such as carpet, wood and tape. This will cause problems with the dryer.



WARNING!

Always have the installation and repairing procedures carried out by the Authorized Service. Manufacturer shall not be held liable for damages that may arise from procedures carried out by unauthorized persons.

- Never wash the dryer by spraying or pouring water onto it! There is the risk of electric shock!

For the products with a steam function:



WARNING!

- Use only distilled water or water condensed in the water tank of the machine in steam programs. Do not use mains water or additives. When using condensed water in the water tank, it should be filtered and cleared of fibres.
- Do not open the door when steam programs are running. Hot water may be expelled.
- Before putting laundry in a steam program, stains on it should be removed.
- You may only put laundry that is not dirty or stained but permeated with unpleasant odour in steam (odour removal) program.
- Do not use any dry cleaning sets or additional materials in a steam program or in any program.

1.1.1 Electrical safety



DANGER!

- Electrical safety instructions should be followed while electrical connection is made during the installation.
- Connect the dryer to a grounded outlet protected by a fuse at the value specified on the type label. Have the grounding installation performed by a qualified electrician. Our company shall not be liable for any damages that will arise when the dryer is used without grounding in accordance with the local regulations.
- The voltage and allowed fuse protection is stated on the type label plate.
- The voltage specified on the type label must be equal to your mains voltage.
- Unplug the dryer when it is not in use.
- Unplug the dryer from the mains during installation, maintenance, cleaning and repair works.
- Do not touch the plug with wet hands! Never unplug by pulling on the cable, always pull out by grabbing the plug.



WARNING!

- The appliance must not be supplied through an external switching device, such as a timer, or connected to a circuit that is regularly switched on and off by utility.



DANGER!

- Do not use extension cords, multi-plugs or adaptors to connect the dryer to power supply in order to decrease the risk of fire and electric shock.
- Power cable plug must be easily accessible after installation.
- Damaged mains cable should be changed notifying the Authorized Service.
- If the dryer is faulty, it must not be operated unless it is repaired by an authorized service agent! There is the risk of electric shock!

1.1.2 Product safety



DANGER!

- Superheating of the clothes inside of the dryer can occur if you cancel the programme or in the event of a power failure whilst the dryer is running, this concentration of heat can cause self-combustion and fire so always activate the ventilation programme to cool down or quickly remove all laundry from the dryer in order to hang them up and dissipate the heat.



WARNING!

- Ensure that the air inlet of the dryer is open and it is well-ventilated.
- Product contains R290 refrigerant.
- R290 is an environment-friendly, but flammable refrigerant.
- Keep the product away from potential heat sources that may cause it to ignite.

**DANGER!****Points to be taken into consideration for fire hazard:**

Below specified laundry or items must not be dried in the dryer considering fire hazard.

- Unwashed laundry items
- Items soiled with oil, acetone, alcohol, fuel oil, kerosene, stain removers, turpentine, paraffin, paraffin removers, petrol, wax or wax removers must be washed in hot water with plenty of detergent before being dried in the dryer.

For this reason especially the items containing the above specified stains must be washed very well, to do this use adequate detergent and choose a high washing temperature.

Below specified laundry or items must not be dried in the dryer due to the fire hazard:

- Garments or pillows bolstered with rubber foam (latex foam), shower bonnets, water resistant textiles, materials with rubber reinforcement and rubber foam pads.

Clothing cleaned with industrial chemicals.

Items such as lighter, match, coins, metal parts, needle etc. may damage the drum set or may lead to functional problems. Therefore check all the laundry that you will load into your dryer.

**WARNING!**

Never stop your dryer before the programme completes. If you must do this, remove all laundry quickly and lay them out to dissipate the heat.

**DANGER!**

- Clothes that are washed inadequately may ignite on their own and even may ignite after drying ends.
- You must provide enough ventilation in order to prevent gases exiting from devices operating with other types of fuels including the naked flame from accumulating in the room due to the back fire effect.

**WARNING!**

- Underwear that contains metal reinforcements should not be dried in the dryer. Dryer may be damaged if metal reinforcements come loose and break off during drying.

**NOTE**

- Use softeners and similar products in accordance with the instructions of their manufacturers.

Always clean the lint filter before or after each loading. Never operate the dryer without the lint filter installed.



WARNING!

- Never attempt to repair the dryer by yourself. Do not perform any repair or replacement procedures on the product even if you know or have the ability to perform the required procedure unless it is clearly suggested in the operating instructions or the published service manual. Otherwise, you will be putting your life and others' lives in danger.
- There must not be a lockable, sliding or hinged door that may block the opening of the loading door in the place where your dryer is to be installed.
- Install your dryer at places suitable for home use. (Bathroom, closed balcony, garage etc.)
- Make sure that pets do not enter the dryer. Check the inside of the dryer before operating it.
- Do not lean on the loading door of your dryer when it is open, otherwise it may fall over.
- The lint must not be allowed to accumulate around the tumble dryer
- The tumble dryer is not to be used if industrial chemicals have been used for cleaning.
- Fabric softeners, or similar products, should be used as specified by the fabric softener instructions.
- Exhaust air must not be discharged into a flue which is used for exhausting fumes from appliances burning gas or other fuels.

1.2 Mounting over a washing machine

- A fixing device should be used between the two machines when installing the dryer above a washing machine. The fitting device must be installed by the authorized service agent.
- Total weight of the washing machine and the dryer -with full load- when they are placed on top of each other reaches to approx. 180 kilograms. Place the products on a solid floor that has sufficient load carrying capacity!



WARNING!

- Washing machine cannot be placed on the dryer. Pay attention to the above warnings during the installation on your washing machine.

Installation Table for Washing Machine and Dryer

Dryer Depth	Washing Machine Depth			
	62 cm	60 cm	54 cm	< 50 cm
54 cm	Can be installed		Cannot be installed	
60 cm	Can be installed		Cannot be installed	

1.3 Intended use

- Dryer has been designed for domestic use. It is not suitable for commercial use and it must not be used out of its intended use.
- Use the dryer only for drying laundry that are marked accordingly.
- The manufacturer waives any responsibility arisen from incorrect usage or transportation.
- The service life of the dryer that you purchased is 10 years. During this period, original spare parts will be available to operate the dryer properly.

1.4 Child safety

- Packaging materials are dangerous for the children. Keep packaging materials away from children.
- Electrical products are dangerous for the children. Keep children away from the product when it is operating. Do not let

them tamper with the dryer. Use the child-proof lock in order to prevent the children to tamper with the dryer.

materials together with the domestic or other wastes. Take them to the packaging material collection points designated by the local authorities.

1.8 Technical Specifications

EN

Height (Min. / Max.)	84,6 cm / 86,6 cm*
Width	59,7 cm
Depth	56,8 cm
Capacity (max.)	8 kg**
Net weight (± %10)	44 kg
Voltage	See type label***
Rated power input	
Model code	

* Min. height: Height with adjustable feet are closed.

Max. height: Height with adjustable feet are opened maximum.

** Dry laundry weight before washing.

*** Type label is located behind the loading door.

	NOTE
<ul style="list-style-type: none"> • Technical specifications of the dryer are subject to specification without notice to improve the quality of the product. • Figures in this manual are schematic and may not match the product exactly. • Values stated on markers on the dryer or in the other published documentation accompanying with the dryer are obtained in laboratory in accordance with the relevant standards. Depending on operational and environmental conditions of the dryer, these values may vary. 	

	NOTE
<p>Child-proof lock is on the control panel. (See Child lock)</p>	

- Keep loading door closed even when the dryer is not in use.

1.5 Compliance with the WEEE Directive and Disposing of the Waste Product:

This product complies with EU WEEE Directive (2012/19/EU). This product bears a classification symbol for waste electrical and electronic equipment (WEEE).



This symbol indicates that this product shall not be disposed with other household wastes at the end of its service life. Used device must be returned to official collection point for recycling of electrical and electronic devices. To find these collection systems please contact to your local authorities or retailer where the product was purchased. Each household performs important role in recovering and recycling of old appliance. Appropriate disposal of used appliance helps prevent potential negative consequences for the environment and human health.

	DANGER!
<ul style="list-style-type: none"> • R290 is an flammable refrigerant. Thus, ensure that the system and the pipes are not harmed during operation and handling. • Keep the product away from potential heat sources that may cause it to ignite in case of damage. • Do not dispose of the product by putting it in fire. 	

1.6 Compliance with RoHS Directive

The product you have purchased complies with EU RoHS Directive (2011/65/EU). It does not contain harmful and prohibited materials specified in the Directive.

1.7 Package information

Packaging materials of the product are manufactured from recyclable materials in accordance with our National Environment Regulations. Do not dispose of the packaging





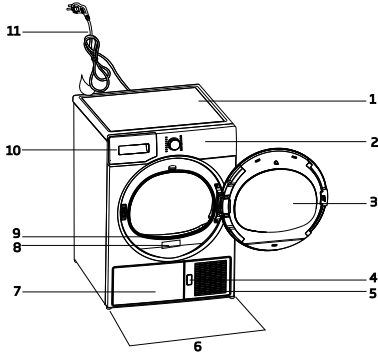

2 Your Dryer

2.1 Overview

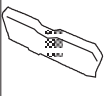

1. Top panel
2. Control panel
3. Loading door
4. Kick plate opening button
5. Ventilation grids
6. Adjustable legs
7. In models where the tank is placed below, the water tank is inside the toe board
8. Type label
9. Lint filter
10. Water tank drawer (in models where the tank is placed above)
11. Power cord

2.2 Package Contents

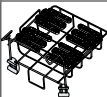
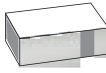
	1. Water drain hose *		5. Drying basket user manual*
	2. Filter drawer spare sponge*		6. Water Filling Container*
	3. User Manual		7. Pure Water*
	4. Drying basket*		8. Fragrance Capsules Group*

*It can be supplied with your machine depending on its model.

3 Installation

Before the calling the nearest Authorized Service for the installation of the dryer, ensure that electrical installation and water drain is appropriate referring to the user's manual. If they are not suitable, contact a qualified electrician and technician to make necessary arrangements.



NOTE

- Preparation of the dryer's location as well as the electrical and waste water installations is under customer's responsibility.



WARNING!

- Prior to installation, visually check if the dryer has any defects on it. If the dryer is damaged, do not have it installed. Damaged products cause risks for your safety.
- Let your dryer wait for 12 hours before starting to use it.

3.1 Appropriate installation location

Install the dryer on a stable and level surface. Dryer is heavy. Do not move it by yourself.

- Operate your dryer in a well ventilated, dust-free environment.
- The gap between the dryer and the surface should not be reduced by the materials such as carpet, wood and tape.
- Do not cover the ventilation grills of the dryer.
- There must not be a lockable, sliding or hinged door that may block the opening of the loading door in the place where your dryer is to be installed.
- Once the dryer is installed, it should stay at the same place where its connections have been made. When installing the dryer, make sure that its rear wall does not touch anywhere (tap, socket, etc.).
- Place the dryer at least 1 cm away from the edges of other furniture.
- Your dryer can be operated at temperatures between +5°C and +35°C. If the operating conditions fall outside of this range, operation of the dryer will be adversely affected and it can get damaged.

- The rear surface of the tumble dryer shall be placed against a wall.

	DANGER!
Do not place the dryer on the power cable.	

* Ignore following warning if your product's system does not contains R290.

	DANGER!
<ul style="list-style-type: none"> • Dryer contains R290 refrigerant.* • R290 is an environment-friendly, but flammable refrigerant.* • Ensure that the air inlet of the dryer is open and it is well-ventilated.* • Keep potential flame sources away from the dryer.* 	

3.2 Removing the transportation safety assembly

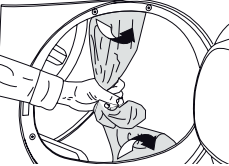
	WARNING!
	<ul style="list-style-type: none"> • Remove the transportation safety assembly before using the dryer for the first time. • If the door swing side of your appliance can be modified, see the reversible door mounting instructions.

3.3 Connecting to the drain

You can directly drain accumulated water through the water drain hose supplied with the product instead of periodically draining the water collected in the water tank.

Connecting the water drain hose

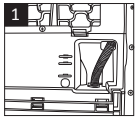
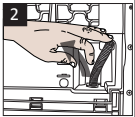
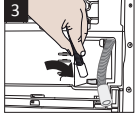
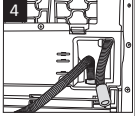
		1-2 Pull hose at the behind of the dryer by hand in order to disconnect it from where it is connected. Do not use any tools to remove the hose.
		
3 Connect one end of the drain hose supplied with the dryer to the connection point from where you removed the hose of the product in previous step.		
4 Connect the other end of the drain hose directly to the wastewater drain or to the washbasin.		

	NOTE
<ul style="list-style-type: none"> • Water drain hose should be attached to a height of maximum 80 cm. • Make sure that the water drain hose is not stepped on and it is not folded between the drain and the machine. • If there is an accessories pack supplied with your product, please see the detailed description. 	

3.4 Adjusting the feet

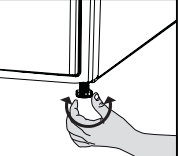
	<ul style="list-style-type: none"> • Turn the feet to left or right until the dryer stands level and firmly.
---	---

3.5 Transportation of the dryer

Drain all water that has remained in the dryer. If direct water drain connection is made, then remove the hose connections.



WARNING!

- We recommend carrying the dryer in upright position. If it is not possible to carry the machine in the upright position, we recommend carrying it by tilting towards the right side when looked from the front.

3.6 Warnings about sounds



NOTE

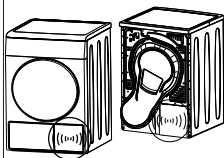

- It is normal to hear a metallic noise from the compressor sometimes during operation.

- Water collected during operation is pumped to water tank. It is normal to hear pumping noise during this process.

3.7 Changing the illumination lamp

In case an illumination lamp is used in your laundry dryer. To change the Bulb/LED used for illumination of your tumble dryer, call your Authorized Service. The lamp(s) used in this appliance is not suitable for household room illumination. The intended purpose of this lamp is to assist the user to place laundry in the tumble dryer in a comfortable way. The lamps used in this appliance have to withstand extreme physical conditions such as vibrations and temperatures above 50 °C

4 Preparation

4.1 Laundry suitable for drying in the dryer

Always obey the instructions given on the garment tags. Dry only the laundry having a label stating that they are suitable for drying in a dryer.

4.2 Laundry not suitable for drying in the dryer



Items with this symbol should not be dried in the dryer.

i NOTE

- Delicate embroidered fabrics, woollen, silk garments, delicate and valuable fabrics, airtight items and tulle curtains are not suitable for machine drying.

4.3 Preparing laundry for drying

- Laundry may be tangled with each other after washing. Separate the laundry items before placing them into the dryer.
- Dry garments having metal accessories such as zippers, inside out.
- Fasten the zippers, hooks and buckles and button sheets.

4.4 Things to be done for energy saving

- Spin your laundry at the highest speed possible when washing them. Thus, the drying time is shortened and energy consumption is reduced.
- Sort out the laundry depending on their type and thickness. Dry the same type of laundry together. For example thin kitchen towels and tablecloths dry quicker than thick bathroom towels.
- Follow the instructions in the user manual for programme selection.
- Do not open the loading door of the machine during drying unless necessary. If you must open the loading door, do not keep it open for a long time.
- Do not add wet laundry while the dryer is in operation
- For models with a condenser unit: clean

the condenser once in a month or after every 30 operations regularly.

- Clean the filter periodically. Read the Maintenance and cleaning of filters for detailed information.
- For models with flue unit: comply with the flue connection instructions and clean the flue.
- During the drying process, air the room well where your tumble dryer is operating
- On models with heat pump, check the condenser at least every 6 months and clean it if it is dirty.
- If you are using the environmentally-friendly filter, you do not need to clean it at every cycle. Replace the filter cloth when the environmentally-friendly filter symbol is displayed on the screen..

4.5 Correct load capacity

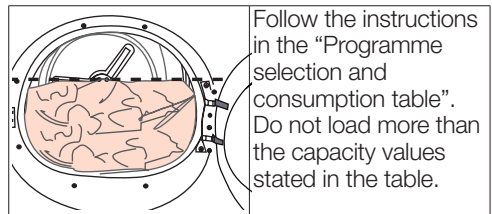

Following weights are given as examples.

Laundry	Approximate weights (g)*	Laundry	Approximate weights (g)*
Cotton quilt covers (double)	1500	Blouses	150
Cotton quilt covers (single)	1000	Cotton shirts	300
Bed sheets (double)	500	Shirts	250
Bed sheets (single)	350	Cotton dresses	500
Large tablecloths	700	Dresses	350
Small tablecloths	250	Jeans	700
Tea towels	100	Handkerchiefs (10 pieces)	100
Bath towels	700	T-Shirts	125
Hand towels	350		

*Dry laundry weight before washing.

5 Operating the product

5.1 Control Panel

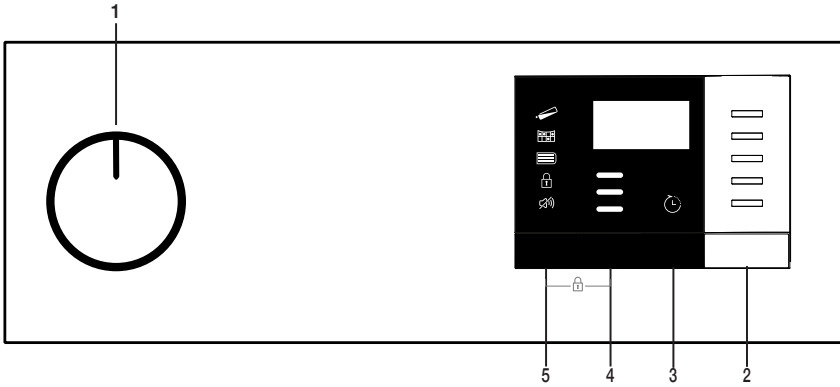

1. On/Off/Program selection button
2. Start/Stand-by button
3. End Time button
4. Drying Level Button
5. Buzzer volume/Time programs selection button

5.2 Symbols

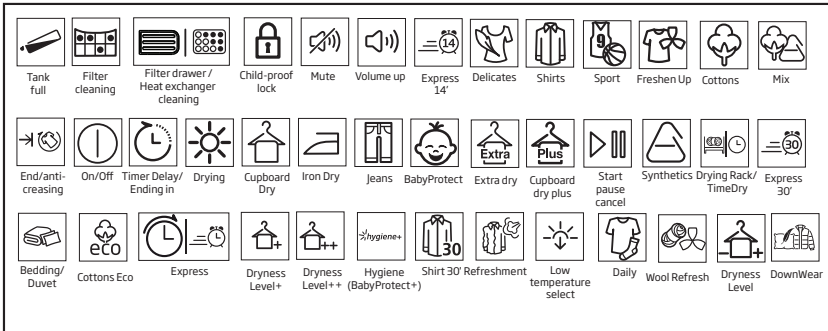

5.3. Preparation of drying machine

- Plug the drying machine.
- Open the loading door.
- Place the laundry to the drying machine without jamming them.
- Push and close the loading door.

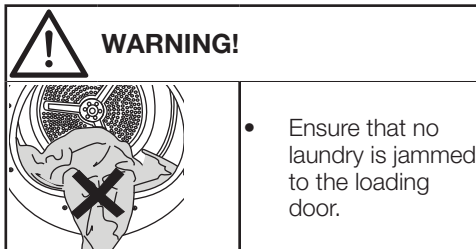

Select the desired program using the On/Off/Program selection knob, the machine will turn on.

NOTE

- Selecting a program using the On/Off/Program selection button does not mean that the program started. Press the Start / Stand-by button to start the program.

5.4 Program selection and consumption chart

EN				
Programmes	Programme Description	Capacity (kg)	Spin speed in washing machine (rpm)	Drying Time (minutes)
Cottons Iron Dry	You may dry your cotton laundry to be ironed in this program to have them slightly damp for ease of ironing. (Shirt, T-shirt, tablecloth, etc.)	8	1000	145
Cottons Eco	It dries single layer, casual cotton textiles in the most economical way.	8	1000	197
Cottons Cupboard Dry	You may use this program for extra dryness in thick laundry such as pants, tracksuit. You can put your laundry in the wardrobe without ironing.	8	1000	210
Cottons Extra Dry	You may dry your thick cotton laundry in this program such as towels, bathrobe, etc. You can put your laundry in the wardrobe without ironing.	8	1000	220
Synthetics Iron Dry	You may dry your synthetic laundry to be ironed in this program to have them slightly damp for ease of ironing. (Shirt, T-shirt, tablecloth, etc.)	4	800	60
Synthetics Cupboard Dry	You may dry all your synthetic laundry in this program. (Shirt, T-shirt, underwear, tablecloth, etc.) You can put your laundry in the wardrobe without ironing.	4	800	70
Timer Programmes	You may select from time programmes between 10 and 160 minutes to achieve the desired drying level at low temperature. In this programme, tumble drier's operation lasts for the set time independently from the dryness of laundry. This product is available to be used with a drying basket as option. For products that are sold without a basket, you can obtain a basket from an authorized service and use the drying programs specified above. For details of use, see the drying basket user guide.	-	-	-
Freshen Up	Ventilates for 10 minutes without blowing hot air. You can ventilate the cotton and linen clothes that have been enclosed for a long time with this program to remove their odour. You can use this program to ventilate and soften wool laundry that can be washed in a washing machine. Do not use for full drying.	-	-	10
Gentle Care / Shirts	It dries the shirts in a more sensitive manner, and causes less creasing and easier ironing.	2	1200	50
Jeans	You may dry denim pants, skirts, shirts or jackets in this program.	4	1200	140
Outdoor/Sports	Use it to dry your clothes made of synthetics, cotton or mixed fabrics or waterproof products such as functional jacket, raincoat etc. Turn them inside out prior to drying.	2	1000	130
Mix / Daily	You can dry both cotton and synthetic laundry with this programme. Sports and fitness clothes may be dried with this program.	4	1000	125

Hygiene +	It is a long-term program that you can use for the clothes (baby clothes, towels, underwear, etc. cotton) you require hygiene. Hygiene is provided with high temperature. It is especially suitable for durable fabrics. ((This program is identified and approved by England's "The British Foundation" (Allergy UK).))	5	800	195
Downwear	You can dry your clothes such as coats and jackets with feathers and fibers which have a label that can be dried in the dryer. Please dry inside out.	-	800	100
Daily Express	Use this program to have 2 shirts ready for ironing.	0,5	1200	30
Energy consumption values				
Programmes	Capacity (kg)	Spin speed in washing machine (rpm)	Approximate amount of remaining humidity	Energy consumption value kWh
Cottons Eco *	8	1000	60%	2,47
Cottons Iron dry	8	1000	60%	2,10
Synthetics cupboard dry	4	800	40%	0,80
	"Cottons Eco programme" used at full and partial load is the standard drying programme to which the information in the label and the fiche relates, that this programme is suitable for drying normal wet Cottons laundry and that it is the most efficient programme in terms of energy consumption for Cottons.			

* : Energy Label standard program (EN 61121:2012) All values in the table are determined according to EN 61121:2012 standard. Consumption values may vary from the values in the chart depending on laundry type, wringing speed, ambient conditions and voltage levels.



Allergy UK is the brand of the British Allergy Association. Seal of Approval is created to guide people that require recommendation about a product that the related product restricts / reduces / eliminates the allergens or reduces the allergen content significantly in the ambient where allergy patients exist. It aims to provide assurance that the products are tested scientifically or examined in a way to provide measurable results.

5.5 Auxiliary functions

Buzzer / time

Drying machine makes an audible warning when the program is completed. If you don't want the machine to make an audible warning, press the "Buzzer / Time" button. When you press the Buzzer/Time button, a light will illuminate and no audible warning will be made when the program ends.



NOTE

- You can select this function before or after the program starts.

Buzzer/Time button is used to adjust program duration while the Rack/Time programs are selected.

Drying Level

Drying Level button is used for adjusting to desired dryness level. Program duration may change depending on the selection.



NOTE

- You can activate this function only prior to start of program.

End time

You can delay the end time of the program up to 24 hours with End time function.

1. Open the loading door and place the laundry.
2. Select the drying program.
3. Press the End Time selection button and set the delay time you wish. End Time LED will illuminate. (When pressed and hold the button, End Time proceeds non-stop).
4. Press the Start / Stand-by button. End Time countdown starts. “:.” Separator in the middle of displayed delay time flashes.



NOTE

- You can add or remove laundry within end time. Displayed time is the sum of normal drying time and end time. End Time LED will turn off at the end of countdown, drying starts and drying LED will illuminate.

Changing the end time

If you want to change the duration during the countdown:

Cancel the program by turning the On/Off/Program selection knob. Select the program you want and repeat the End Time selection process.

Canceling the end time function

If you want to cancel the end time countdown and start the program immediately:

Cancel the program by turning the On/Off/Program selection knob. Select the program you want and press the Start/Stand-by button.

5.6 Warning indicators



NOTE

- Warning indicators may vary depending on the model of your dryer.

Filter cleaning

When the program is completed, the warning indicator for filter cleaning turns on.

Water tank

When the program is completed, the warning indicator to empty the water tank turns on.

If the water tank fills up while the program continues, the warning indicator starts flashing and the machine goes into stand-by. In this case, empty the water tank and start the program by pressing the Start / Stand-by

button. Warning indicator turns off and program resumes.

Filter drawer /Heat exchanger cleaning

When the programme is finished, the cleaning symbol of the heat exchanger or filter drawer may light up.

5.7 Starting the program

Press the Start/Stand-by button to start the program.

Start/Stand-by and Drying indicators will illuminate to indicate that program started.

5.8 Child Lock

The drying machine has a child lock which prevents the program flow from being interrupted when the buttons are pressed during a program. When the child lock is activated, all buttons on the panel except the On/Off/Program selection knob are deactivated.

Press the Drying Level and Buzzer buttons simultaneously for 3 buttons to activate the child lock.

The child lock has to be deactivated to be able to start a new program after the current program is finished or to be able to interfere with the program. To deactivate the child lock, keep the same buttons pressed for 3 seconds.



NOTE

- When the child lock is activated, the child lock warning indicator on the screen turns on.
- Child lock deactivates when the drying machine is turned off and on by the On/Off/Cancel knob.



NOTE

- When the drying machine runs and the child lock is active, it beeps twice when the program selection knob is turned. If the child lock is deactivated without returning the program selection knob to its previous position, program will terminate due to the change in the program selection knob position.

5.9 Changing the program after it is started

You can change the program you selected to dry your laundry with a different program after the drying machine starts running

- For instance, select Extra Dry program by turning the On/Off/Program selection knob to select Extra Dry instead of Iron Dry.
- Press the Start/Stand-by button to start the program.

Adding and removing clothes during stand-by

If you want to add or remove clothes to/from the drying machine after the drying program starts:

- Press the Start/Stand-by button to put the drying machine in Stand-by state. The drying operation stops.
- Open the loading door while in Stand-by state, and close the door after you remove or add laundry.
- Press the Start/Stand-by button to start the program.



NOTE

- Adding laundry after the drying operation starts may cause the dried laundry inside the machine to mix with wet laundry and leave the laundry damp at the end of operation.
- Adding or removing laundry during drying may be repeated as many times as you wish. But this operation continuously interrupts the drying operation, and thus increases program duration and energy consumption. So, it is recommended to add laundry before the program starts.
- If a new program is selected by turning the program selection knob while the drying machine is in stand-by, the running program terminates.

5.10 Cancelling the program

If you want to cancel the program and terminate the drying operation for any reason after the drying machine starts running, turn the On/Off/Cancel knob, the program will be cancelled.



WARNING!

- The inside of the drying machine shall be extremely hot when you cancel the program during machine operation, so run the refresh program to allow it to cool down.

5.11 End of program

When the program ends, the Fibre Filter Cleaning and Water Tank warning symbols on the program observation indicator turn on. Loading door may be opened and the dryer machine becomes ready for another run. Bring the On/Off/Program selection knob to On/Off position to turn the drying machine off.



NOTE

- If the laundry is not removed after the program is completed, the wrinkle prevention function activates for 2 hours to prevent the laundry inside the machine to get wrinkled. The program tumbles the laundry with 10-minute intervals to prevent them from wrinkling.



WARNING!

- Do not touch the inner surface of the drum while adding or removing clothes during a continuing program. The drum surface is hot.

6 Maintenance and cleaning

6.1 Loading Door Inner Surface

The hair and fibres that are separated from the laundry during drying process is collected by the Fibre Filter.

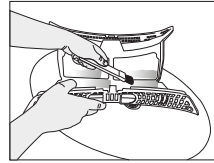

NOTE

- Fibres are formed during wearing and washing clothes.
- You can clean the filter slot with a vacuum cleaner.



WARNING!

- After each drying cycle, clean the fibre filter and the inner surface of the loading door.

To clean the fibre filter:

- Open the loading door.
- Hold the first part (inner filter) of the two part fibre filter and remove it by pulling it upwards.
- Collect the hair, fibres and cotton balls with hand or with a soft cloth.
- Remove the second part (outer filter) by pulling it upwards.

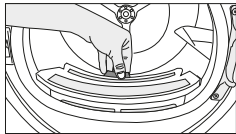
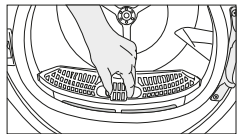

NOTE

- Ensure that hair, fibre and cotton balls do not fall into the slot where the filters are installed.

- Open both filters (top and bottom filters) and to remove the lint with your hand, or use cleaning brush at air routing cover. And if necessary, use a vacuum cleaner to clean filters.



- Clean both filters under water running in reverse direction of fibre accumulation or with a soft brush. Dry the filter before placing it back.

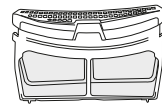
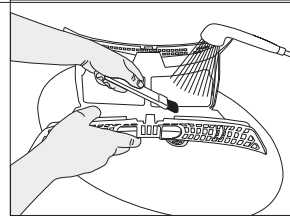
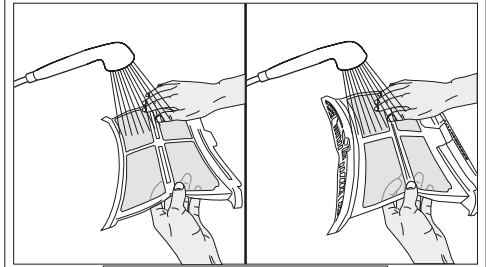

- Insert the fibre filters on one another and place it back in its place.

- Clean the front door interior surface and its gaskets with a soft damp cloth or with the brush on air routing cover.

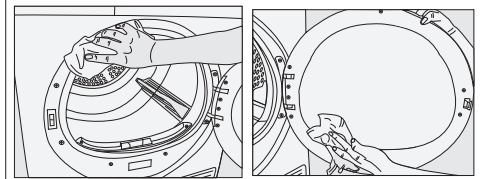

6.2 Cleaning the sensors

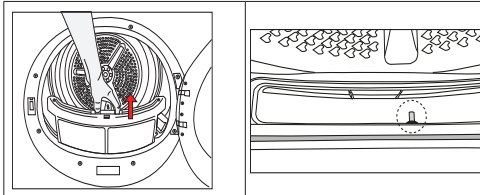

- There are temperature sensor in the dryer that detect whether the laundry is dry or not.

To clean the sensors:

- Open the loading door of the dryer.
- Remove the lint filter by pulling it up.
- Clean the sensor with your hand if any fluff accumulation on it.



NOTE

- Clean the sensor 4 times a year.
- Do not use metal tools when cleaning the sensor.
- Allow the machine to cool down if it is still hot due the drying process.



WARNING!

- Never use solvents, cleaning agents or similar substances for cleaning due to the risk of fire and explosion!

6.3 Draining the water tank

Dampness of the laundry is removed and condensed during drying process and the water that arise accumulates in the water tank. Drain the water tank after each drying cycle.



WARNING!

- Condensed water is not drinkable!
- Never remove the water tank when the program is running!

If you forget to drain the water tank, the machine will stop during the subsequent drying cycles when the water tank is full and the Water Tank warning symbol will flash. If this is the case, drain the water tank and press Start / Pause button to resume the drying cycle.

To drain the water tank:

1. Remove the water tank in the drawer or container carefully.

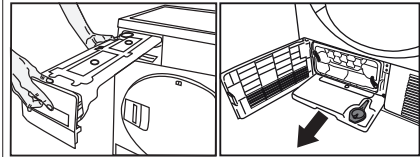

2. Drain the water in the tank.

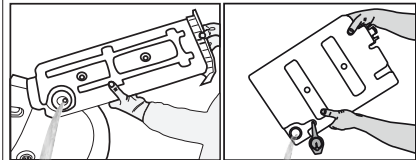

- If there is lint accumulation in the funnel of the water tank, clean it under running water.
- Place the water tank into its seat.



NOTE

- If the direct water draining is used as an option, there is no need to empty the water tank.

6.4 Cleaning the Condenser

Small amount of lint may pass through the lint filter and be collected on the metal surface of the condenser.

Condenser metal surface needs to be cleaned regularly.

If the evaporator icon is flashing on the display, please inspect the metal surface of the condenser. If it is dirty, clean it. This part should be checked at least once every 6 months.

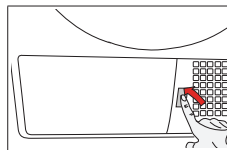

- Open the toe board by pressing on it.

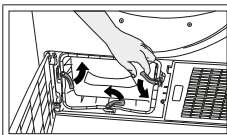

- To open the air routing door, move the release latch.

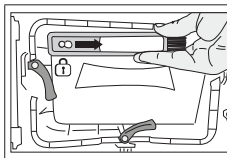

- Insert the brush into its slot pushing to the right, after cleaning condenser, front cover and lint filter.

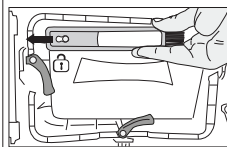

- Pull the brush to the left side and remove it. You can use the cleaning brush for removing collected fluff on the metal surface of the condenser.

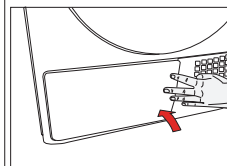

- After the cleaning process is completed, place the air router door to its place, move the latches to close it and close the toe board.



NOTE

- Brush is inside the printing materials bag. You can place it in its housing on the air routing cover after the first usage.



WARNING!

- You can clean by hand, provided you wear protective gloves. Do not try to clean with bare hands. Condenser fins may damage your hands. Cleaning by the left to right movements may damage the condenser fins. This may lead to drying issues.

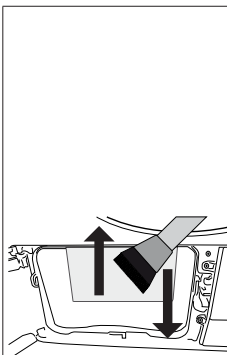

- Collected fluff on condenser surface should be removed by a damp cloth or rubbing the brush placed on the air routing cover up and down on the condenser.

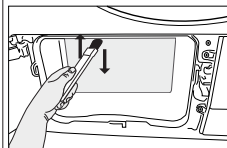

- Please do not clean condenser fins in right-left direction to avoid damage.
- You can also use a vacuum cleaner with a brush for cleaning. Condenser cleaning is not recommended with a brushless vacuum cleaner.

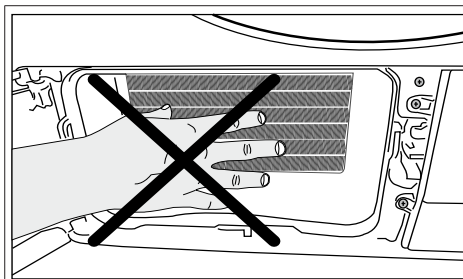

WARNING!

- It is normal to see some water on the plastic surface in front of the condenser when you open the air routing cover.

7 Troubleshooting

Drying operation takes too long.
Fibre filter pores might be clogged. >>> Wash the filter with warm water. Filter drawer might be clogged. >>> Clean the sponge and filter cloth (if any) in the filter drawer. (for the products with a heat pump) The condenser might be blocked. >>> Wash the condenser.(for the products with a condenser) The ventilation grills in front of the machine may be closed. >>> Remove any objects in front of the ventilation grills that blocks air. Ventilation may be inadequate because the area the machine is installed in is too small. >>> Open the door or windows to prevent the room temperature from rising very high. A lime layer may have accumulated on the humidity or temperature sensors. >>> Clean the humidity or temperature sensors. Excessive amount of laundry might be loaded. >>> Do not load the drying machine excessively. Laundry might not have been wrung adequately. >>> Perform a higher speed wringing on the washing machine.
Clothes come out damp after drying.
A program not suitable for the laundry type may have been used.>>> Check the maintenance labels on the clothes and select a program suitable for the clothes' type or use time programs as extra. Fibre filter pores might be clogged. >>> Wash the filter with warm water. The condenser might be blocked. >>> Wash the condenser. (for the products with a condenser) Filter drawer might be clogged. >>> Clean the sponge and filter cloth (if any) in the filter drawer.(For the products with a heat pump) Excessive amount of laundry might be loaded. >>> Do not load the drying machine excessively. Laundry might not have been wrung adequately. >>> Perform a higher speed wringing on the washing machine.
Drying machine does not turn on or program cannot be started. Drying machine does not run after it is configured.
Power plug might be unplugged. >>> Make sure the power cord is plugged in. Loading door might be open. >>> Ensure that the loading door is properly closed. A program might not be set or Start/Stand-by button might not be pressed. >>> Check that the program is set and it is not in Stand-by position. Child lock may be activated. >>> Turn off the child lock.
Program terminated prematurely for no reason.
Loading door might not be closed completely. >>> Ensure that the loading door is properly closed. There might be a power outage. >>> Press the Start/Stand-by button to start the program. Water tank may be full. >>> Empty the water tank.
Clothes have shrunk, hardened or spoiled.
A program not suitable for the laundry type might have been used. >>> Check the maintenance labels on the clothes and select a program suitable for the clothes.
The lighting inside the drying machine does not turn on. (For models with a lamp)
Drying machine might not be turned on with the On/Off button or program might not be selected for machines without an On/Off button. >>> Make sure that the drying machine is turned on. Lamp might be malfunctioning. >>> Contact Authorized Service to replace the lamp.

Filter cleaning warning symbol/LED is on/flashing.
Fibre filter might not be cleaned. >>> Clean the filter. The filter slot might be clogged with lints. >>> Clean the filter slot. A layer of fluff might have accumulated clogging up the lint filter pores. >>> Wash the filter with warm water. The condenser might be blocked. >>> Wash the condenser.
Water drips from the loading door.
Fibres might have gathered on the inner sides of the loading door and the loading door gasket. >>> Clean the inner surfaces of the loading door and the loading door gasket surfaces.
Loading door opens by itself.
Loading door might not be closed completely. >>> Push the loading door until the closing sound is heard.
Water tank warning symbol / led is on/flashing.
Water tank may be full. >>> Empty the water tank. Water discharge hose might have collapsed. >>> If the product is connected directly to the water drain check the water discharge hose.
Steam symbol is flashing.(For the products with a steam function)
Steam tank may be empty => Fill the steam tank with distilled or condensed water.
Steam programs do not start (For the products with a steam function)
Steam tank may be empty, steam tank warning icon may light up on the screen => Fill the steam tank until the steam icon goes off.
Wrinkles are not removed with wrinkle removing program. (For the products with a steam function)
Excess amount of laundry may have been placed => Place specified amount of laundry. Steam application time may be selected in low level => Choose a program with high amount of steam. After completion of the program, the laundry may have stayed in the machine for a long time => Take the laundry out as soon as the program finishes, and hang it out.
Laundry odour not lessened with the odour removal program.(For the products with an odour removal program)
Excess amount of laundry may have been placed => Place specified amount of laundry. Steam application time may be selected in low level => Choose a program with high amount of steam.



WARNING!

- If the problem persists after following the instructions in this section, contact your vendor or an Authorized Service. Never try to repair your product yourself.



NOTE

- In an event that you encounter an issue on any part on your appliance, you can ask for a replacement by contacting the authorized service with the appliance model number.
- Operating the appliance with non-authentic parts may lead the appliance to malfunction.
- Manufacturer and distributor are not liable for malfunctions resulting from using non-authentic parts.

PRODUCT FICHE

Complying Commission Delegated Regulation (EU) No 392/2012

Supplier name or trademark		BEKO
Model name		DS8312PX 7188235080
Rated capacity (kg)		8.0
Type of Tumble Dryer	Air Vented	-
	Condenser	•
Energy efficiency class ⁽¹⁾		A+
Annual Energy Consumption (kWh) ⁽²⁾		297,0
Type of Control	Automatic	•
	Non-automatic	-
Energy consumption of the standard cotton programme at full load (kWh)		2,47
Energy consumption of the standard cotton programme at partial load (kWh)		1,35
Power consumption of the off-mode for the standard cotton programme at full load, P ₀ (W)		0,50
Power consumption of the left-on mode for the standard cotton programme at full load, P _L (W)		1,00
The duration of the left on mode (min)		30
Standard cotton programme ⁽³⁾		•
Programme time of the standard cotton programme at full load, T _{dy} (min)		197
Programme time of the standard cotton programme at partial load, T _{dy1/2} (min)		115
Weighted programme time of the standard cotton programme at full and partial load (T _d)		150
Condensation efficiency class ⁽⁴⁾		B
Average condensation efficiency of the standard cotton programme at full load, C _{dry}		81%
Average condensation efficiency of the standard cotton programme at partial load, C _{dry1/2}		81%
Weighted condensation efficiency of the standard cotton programme at full load and partial load, C _t		81%
Sound power level for the standard cotton programme at full load ⁽⁵⁾		65
Built-in		-

• : Yes - : No

(1) Scale from A+++ (most efficient) to D (least efficient)

(2) Energy consumption based on 160 drying cycles of the standard cotton programme at full and partial load, and the consumption of the low-power modes. Actual energy consumption per cycle will depend on how the appliance is used.

(3) "Cotton cupboard dry programme" used at full and partial load is the standard drying programme to which the information in the label and the fiche relates, that this programme is suitable for drying normal wet cotton laundry and that it is the most efficient programme in terms of energy consumption for cotton

(4) Scale from G (least efficient) to A (most efficient)

(5) Weighted average value — L_{WA} expressed in dB(A) re 1 pW

Najpre pročitajte ovo uputstva za upotrebu!

Poštovani kupče,
Zahvaljujemo vam što birate proizvod Beko. Nadamo se da će vam naš proizvod koji je proizveden u skladu sa najvišim kvalitetom i najboljom tehnologijom dati najbolje rezultate. Savetujemo Vam da prvo pažljivo pročitate ova uputstva i celokupnu ostalu prateću dokumentaciju pre upotrebe proizvoda i da ih sačuvate za ubuduće. Ako date proizvod nekome, dajte im i priručnik za upotrebu. Obratite pažnju na sve detalje i upozorenja navedena u korisničkom priručniku i poštujujte uputstva tamo data. Koristite ovo korisničko uputstvo za model naznačen za korici.



- Pročitajte uputstva.

Objašnjenje simbola

U ovom priručniku za korisnike korišće se sledeći simboli:



OPASNOST!

- Upozorenje zbog strujnog udara.



OPASNOST!

- Upozorenje za opasnost od požara.



UPOZORENJE

- Upozorenje za situacije opasne po život i materijalna dobra.



UPOZORENJE

- Upozorenje za vruće površine.



UPOZORENJE

- Upozorenje na opasnost od opekotina.



NAPOMENA

- Važne informacije ili korisni saveti o upotrebi.



Materijali za pakovanje ovog proizvoda proizvedeni su od materijala koji se mogu reciklirati u skladu sa nacionalnim propisima o zaštiti životne sredine.

Nemojte da odlažete ambalažni otpad sa kućnim otpadom ili drugim vrstama otpada, odložite ga u predodređene sabirne centre koje su odredili lokalni nadležni organi.



Ovaj proizvod je proizveden korišćenjem najnovije tehnologije u ekološki prihvatljivim uslovima.

1 Važna uputstva vezana za bezbednost i životnu sredinu



NAPOMENA

- Ovaj deo sadrži bezbednosna uputstva koja će vam pomoći da se zaštitite od opasnosti od telesnih povreda ili materijalnih šteta. Nepoštovanje ovih uputstava dovešće do gubitka garancije.

1.1 Opšta bezbednost



UPOZORENJE

Ovaj uređaj ne smeju da koriste deca mlađa od 8 godina, kao ni osobe sa ograničenim fizičkim ili mentalnim sposobnostima, niti osobe koje nemaju dovoljno znanja ili iskustva u korišćenju ovog uređaja, osim ako su pod nadzorom osobe koja je odgovorna za njihovu bezbednost i ako su od nje dobile uputstva o pravilnom korišćenju ovog proizvoda. Deca ne smeju da se igraju uređajem. Deca ne smeju da čiste ili održavaju aparat bez odgovarajućeg nadzora.

- Podesive nožice ne treba uklanjati. Prostor između mašine za sušenje veša i poda ne treba smanjivati materijalima kao što su tepisi, drvo i traka. To može da prouzrokuje probleme sa mašnom za sušenje veša.



UPOZORENJE

Instalaciju i popravku uvek treba da obavlja ovlašćeni serviser. Proizvođač neće biti odgovoran za štete koje mogu nastati usled radova koje su obavila neovlašćena lica.

- Nikada nemojte da perete mašinu za sušenje veša prskanjem ili prosipanjem vode! Postoji opasnost od električnog udara!

Za proizvode sa funkcijom pare:



UPOZORENJE

- Koristite samo destilovanu vodu ili vodu koja se kondenzovala u rezervoaru za vodu mašine u programima sa parom. Nemojte da koristite vodu iz glavnog vodovoda ili aditive. Kada koristite kondenzovanu vodu u rezervoaru za vodu treba da se filtrira i očisti od vlakana.
- Nemojte da otvarate vrata kada su pokrenuti programi sa parom. Može doći do izbacivanja vruće vode.
- Pre stavljanja veša u program sa parom, potrebno je ukloniti mrlje sa njega.
- Smete da stavljate samo veš koji nema mrlje i nije zaprljan, već prožet neprijatnim mirisima u program sa parom (uklanjanje neprijatnih mirisa).
- Nemojte da koristite bilo koje komplete za suvo čišćenje ili dodatne materijale u programu sa parom ili bilo kom drugom programu.

1.1.1 Električna bezbednost



OPASNOST!

- **Treba poštovati uputstva za električnu bezbednost tokom priključivanja na električnu mrežu.**
- **Uređaj ne sme da se napaja preko spoljnog prekidača, kao što je tajmer, ili da se priključi na strujno kolo koje se redovno isključuje i uključuje po potrebi.**
- Priključite mašinu za sušenje veša na uzemljenu utičnicu zaštićenu osiguračem sa vrednošću naznačenom na etiketi. Obezbedite da uzemljenje obavi kvalifikovani električar. Naša kompanija se ne smatra odgovornom za oštećenja koja proističu iz korišćenja mašine za sušenje veša bez uzemljenja u skladu sa lokalnim propisima.
- Napon i dozvoljena zaštita osigurača su navedeni na pločici sa podacima.
- Napon naveden na etiketi mora da bude jednak naponu vaše električne mreže.
- Isključite mašinu za sušenje veša kad se ne koristi.
- Isključite kabl za napajanje mašine za sušenje veša iz strujne utičnice tokom instalacije, održavanja, čišćenja i popravke.
- Nemojte da dodirujete utikač mokrim rukama! Nikad nemojte da isključujete mašinu iz struje tako da je povlačite za kabl, uvek hvatajte i vucite utikač.



OPASNOST!

- Da bi se smanjio rizik od električnog udara, ne koristite produžne kablove, razvodnike ili adaptere za povezivanje mašine za sušenje na elektro mrežu.
- Utikač kabla za napajanje mora da bude lako dostupan nakon ugradnje.
- **Oštećeni kabl za napajanje treba zameniti obaveštavanjem ovlašćenog servisera.**
- **Ako je mašina za sušenje neispravna, ne sme se koristiti osim ako je ne popravlja ovlašćeni serviser! Postoji opasnost od električnog udara!**

1.1.2 Bezbednost proizvoda



UPOZORENJE!

- Obezbedite da dovod vazduha na mašini za sušenje bude otvoren i dobro provetren.
- Proizvod sadrži rashladno sredstvo R290.
- R290 je ekološko, ali zapaljivo rashladno sredstvo.
- Proizvod udaljite od potencijalnih izvora toplote koji mogu da izazovu paljenje.



OPASNOST!

- Prekomerno zagrevanje odeće unutar mašine za sušenje može da nastane ako otkazete program ili u slučaju nestanka struje dok je mašina za sušenje pokrenuta, a ta koncentracija toplote može da izazove samosagorevanje i požar, tako da uvek aktivirajte program ventilacije da ohladite ili brzo uklonite sav veš iz mašine za sušenje da biste ga okačili i da bi se uklonila toplota.



OPASNOST!

Tačke koje treba razmotriti zbog opasnosti od požara:

Dolenavedeni veš ili odeća se ne smeju sušiti u mašini za sušenje zbog opasnosti od požara.

- Neoprani veš
- Predmeti zaprljani uljem, acetonom, alkoholom, lož uljem, kerozinom, sredstvima za uklanjanje mrlja, terpentinom, parafinom, sredstvima za uklanjanje parafina, benzinom, voskom ili sredstvima za uklanjanje voska moraju da se operu u toploj vodi sa mnogo deterdženta pre sušenja u mašini za sušenje.
- Iz tog razloga, naročito odeća koja sadrži gorenavedene mrlje se mora isprati veoma dobro, da biste to učinili koristite odgovarajući deterdžent i izaberite visoku temperaturu pranja.

Dolenavedeni veš ili odeća se ne smeju sušiti u mašini za sušenje veša zbog opasnosti od požara:



OPASNOST!

- Odeća ili jastuci punjeni penastom gumom (lateks pena), kape za tuširanje, vodootporni tekstil, materijali obloženi gumom i jastuci punjeni penastom gumom.
- Odeća koja je čišćena industrijskih hemikalijama.
- Predmeti kao što su upaljač, šibice, novčići, metalni delovi, igla itd. mogu oštetiti bubanj ili mogu dovesti do problema u funkcionisanju. Stoga proverite sav veš koji stavljate u mašinu.
- Nikada nemojte da zaustavljate mašinu za sušenje veša pre nego što se program završi. Ako to morate da učinite, izvadite sav veš brzo i postavite ga tako da otpusti toplotu. Odeća koja se pere neadekvatno može se spontano zapaliti ili se može zapaliti čak i nakon završetka sušenja.
- Morate da obezbedite dovoljnu ventilaciju kako biste sprečili da se gasovi koji izlaze iz uređaja koji rade sa raznim vrstama goriva, kao i otvoreni plamen, sakupljaju u prostoriji zbog efekta povratne vatre.



UPOZORENJE

- Donji veš koji sadrži metalna ojačanja ne treba sušiti u mašini za sušenje veša. Mašina za sušenje veša se može oštetiti ako se metalna ojačanja otkace ili polome u toku sušenja.



NAPOMENA

- Koristite omekšivače i slične proizvode u skladu sa uputstvima njihovih proizvođača.
- Pre ili posle svakog punjenja uvek očistite filter za dlačice. Nikad ne koristite aparat za sušenje bez filtera za dlačice.



UPOZORENJE

- Nikada nemojte sami da pokušavate da popravite mašinu za sušenje veša. Nemojte da vršite nikakve popravke ili procedure zamene rezervnih delova kod ovog proizvoda čak i ako znate ili ste u mogućnosti da to radite, osim ako to nije jasno predloženo u uputstvima za upotrebu ili štampanom servisnom uputstvu. Inače ćete dovesti u opasnost svoj život i živote drugih.
- Ne smeju da postoje vrata koja se zaključavanju, klizaju ili poseduju šarke tako da blokiraju otvaranje vrata za ubacivanje veša na mestu gde treba postaviti mašinu za sušenje veša.
- Postavite mašinu za sušenje veša na mestima pogodnim za upotrebu u domaćinstvu. (Kupatilo, zatvorena terasa, garaža itd.)
- Postarajte se da kućni ljubimci ne uđu u mašinu za sušenje veša. Proverite unutrašnjost mašine za sušenje veša pre korišćenja.
- Nemojte da se naslanjate na vrata mašine za sušenje veša dok su otvorena, jer mogu pasti.



UPOZORENJE

- Otpaci od prediva se ne smeju akumulirati oko mašine za sušenje.
- Mašinu za sušenje veša ne treba koristiti ako se za čišćenje koriste industrijske hemikalije.
- Omekšivači za veš ili slični proizvodi treba da se koriste kako je naznačeno u uputstvima na omekšivačima za veš.
- Izduvni vazduh ne sme da se izbacuje kroz dimnjak koji se koristi za izduvnu paru iz uređaja koji sagorevaju gas ili druga goriva.

1.2 Montaža na mašini za pranje veša

- Treba da se koristi montažni element između dve mašine kada se mašina za sušenje veša montira na mašinu za pranje veša. Uređaj za pričvršćivanje treba da postavi ovlašćeni serviser.
- Ako ukupna težina mašine za pranje veša i mašine za sušenje veša kada su postavljene jedna na drugu, sa punim opterećenjem, je oko 180 kilograma. Proizvode postavite na čvrst pod koji može da izdrži ovo opterećenje!



UPOZORENJE

- Mašina za pranje veša se ne može postaviti na mašinu za sušenje veša. Obratite pažnju na gornja obaveštenja tokom instalacije vaše mašine za pranje veša.

Tabela za instalaciju za mašinu za pranje i mašinu za sušenje veša

Dubina mašine za sušenje veša	Dubina mašine za pranje veša			
	62 cm	60 cm	54 cm	< 50 cm
54 cm	Može da se instalira			Ne može da se instalira
60 cm	Može da se instalira		Ne može da se instalira	

1.3 Namenjena upotreba

- Mašina za sušenje veša je dizajnirana za upotrebu u domaćinstvu. Nije prikladna za komercijalnu upotrebu i ne sme se koristiti izvan svoje namene.
- Ovu mašinu za sušenje veša koristite samo za sušenje veša koji je označen za to.
- Proizvođač ne prihvata odgovornost koja proističe iz nepravilne upotrebe ili prenosa.
- Vek rada mašine za sušenje veša koju ste kupili je 10 godina. Tokom ovog perioda, originalni rezervni delovi će biti dostupni za pravilno rukovanje mašinom za sušenje veša.

1.4 Bezbednost dece

- Materijali pakovanja su opasni za decu. Pakovanja držite dalje od dece.
- Električni proizvodi su opasni za decu. Držite decu dalje od ovog proizvoda dok radi. Nemojte da im dajete da diraju mašinu za sušenje veša. Koristite zaključavanje zbog dece da biste sprečili da deca diraju mašinu za sušenje veša.

 NAPOMENA
Zaključavanje zbog dece se nalazi na kontrolnoj tabli. (Pogledajte Zaključavanje zbog dece)

- Vrata za ubacivanje veša treba da budu zatvorena čak i kada mašina nije u upotrebi.

1.5 Usaglašenost sa WEEE direktivom i odlaganje otpada



Ovaj proizvod je usaglašen sa WEEE direktivom Evropske Unije (2012/19/EU). Ovaj proizvod sadrži simbol klasifikacije za električni i elektronski otpad (WEEE).

Ovaj proizvod je napravljen od delova visokog kvaliteta i materijala za višekratnu upotrebu i pogodni su za reciklažu. Nemojte odlagati proizvod u otpad sa običnim kućnim otpadom i drugim otpadima na kraju veka trajanja. Odložite ga u centar za sakupljanje i reciklažu električnog i elektronskog otpada. Konsultujte se sa svojim lokalnim vlastima da biste saznali o ovim centrima za sakupljanje otpada.



OPASNOST!

- R290 je zapaljivo rashladno sredstvo. Zbog toga pazite da se sistem i cevi ne oštete tokom rada i rukovanja.
- Proizvod udaljite od potencijalnih izvora toplote koji mogu da izazovu paljenje u slučaju oštećenja.
- Ne odlažite proizvod tako što ćete ga spaljivati.

1.6 Usaglašenost sa RoHS direktivom:

Proizvod koji ste kupili u saglasnosti je sa RoHS direktivom Evropske Unije (2011/65/EU). On ne sadrži štetne i zabranjene materijale navedene u direktivi.

1.7 Informacije o pakovanju

Materijali za pakovanje ovog proizvoda proizvedeni su od materijala koji se mogu reciklirati u skladu sa nacionalnim propisima o zaštiti životne sredine. Materijale za pakovanje ne odlagati zajedno sa kućnim ili drugim otpadom. Odnosite ih na mesta za prikupljanje ambalažnog materijala određena od strane lokalne vlasti.

1.8 Tehničke specifikacije

SB

Visina (min. / maks.)	84,6 cm / 86,6 cm*
Širina	59,7 cm
Dubina	56,8 cm
Kapacitet (maks.)	8 kg**
Neto težina (± %10)	44 kg
Napon	Pogledajte tipsku pločicu***
Označeni ulaz snage	
Šifra modela	

* Min. visina: Visina dok su podesive nožice zatvorene.

Maks. visina: Visina dok su podesive nožice maksimalno otvorene.

** Težina veša za sušenje pre pranja.

*** Tipska pločica se nalazi iza vrata za punjenje.



NAPOMENA

- Tehničke specifikacije mašine za sušenje veša su podložne izmenama bez prethodnog obaveštenja u cilju poboljšanja kvaliteta proizvoda.
- Slike u ovom priručniku su shematske i možda ne odgovaraju u potpunosti ovom proizvodu.
- Vrednosti navedene na oznakama mašine za sušenje veša ili na štampanim materijalima koji su dostavljeni s proizvodom su vrednosti dobijene u laboratoriju prema odgovarajućim standardima. Zavisno od uslova rada i okoline mašine za sušenje veša, vrednosti mogu biti različite.

2 Vaša mašina za sušenje

2.1 Pregled

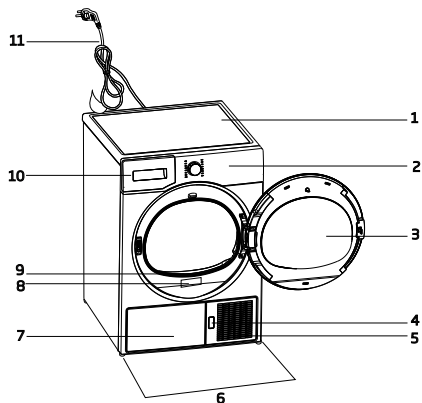

1. Gornji panel
2. Kontrolni panel
3. Vrata za punjenje
4. Dugme za otvaranje ploče u podnožju mašine
5. Ventilacione rešetke
6. Podesive nožice
7. Kod modela gde je rezervoar smešten ispod rezervoara za vodu je unutar donje ploče
8. Tipska pločica
9. Filter za dlačice
10. Fioka rezervoara za vodu (kod modela gde je rezervoar postavljen iznad)
11. Kabl za napajanje

2.2 Sadržaj paketa

	1. Crevo za odvod vode *		5. Korisničko uputstvo za korpu za sušenje*
	2. Rezervni sunđer za fioku za filter*		6. Posuda za punjenje vode*
	3. Priručnik za korisnika		7. Čista voda*
	4. Korpa za sušenje*		8. grupa mirisnih kapsula*

*Može se isporučiti sa vašom mašinom u zavisnosti od modela.

Mašina za sušenje/ Priručnik za korisnika

3 Postavljanje

Pre pozivanja najbližeg ovlašćenog servisa za instalaciju mašine za sušenje, proverite da li su električne instalacije i crevo za odvod vode odgovarajući tako što ćete pogledati korisničko uputstvo. Ako nisu odgovarajući, kontaktirajte sa kvalifikovanim električarom i tehničarom koji će obaviti potrebne izmene.



NAPOMENA

- Priprema mesta postavljanja mašine za sušenje, kao i električne i kanalizacione instalacije spadaju u odgovornost kupca.



UPOZORENJE

- Pre instalacije vizuelno proverite da li na njemu postoje oštećenja. Ako je proizvod oštećen, nemojte da ga instalirate. Oštećeni proizvodi mogu da izazovu opasnost po vašu bezbednost.
- Neka mašina za sušenje veša miruje 12 sati pre uključivanja.

3.1 Odgovarajuća lokacija za instalaciju

Mašinu za sušenje veša instalirajte na stabilnu i ravnu površinu.

Mašina za sušenje veša je teška. Ne pomerajte je sami.

- Mašinu za sušenje veša koristite u dobro provetrenoj sredini bez prašine.
- Prostor između mašine za sušenje veša i površine ne treba smanjiti materijalima kao što su tepih, drvo i traka.
- Nemojte da prekrivate ventilacione rešetke mašine za sušenje veša.
- Ne smeju da postoje vrata koja se zaključavanju, klizaju ili poseduju šarke tako da blokiraju otvaranje vrata za ubacivanje veša na mestu gde treba postaviti mašinu za sušenje veša.
- Kada se mašina za sušenje veša instalira, treba da ostane na mestu na kome su instalirani priključci. Prilikom instalacije proizvoda se pobrinite da njegova zadnja strana ne bude u dodiru ni sa jednom površinom (slavina, utičnica itd.).

- Proizvod postavite najmanje 1 cm od ivica drugog nameštaja.
- Vaš proizvod može da radi na temperaturama između +5°C i +35°C. U slučaju da radni uslovi premašuju ovaj opseg, to će se negativno odraziti na rad ovog proizvoda, može se i oštetiti.
- Zadnja strana mašine za sušenje treba se postaviti nasuprot zidu.

 **OPASNOST!**

Nemojte da stavljate mašinu za sušenje veša na kabl za napajanje.

*** Zanemarite sledeće upozorenje ako sistem vašeg proizvoda ne sadrži R290**

 **OPASNOST!**

- Proizvod sadrži rashladno sredstvo R290.*
- R290 je ekološko, ali zapaljivo rashladno sredstvo.*
- Obezbedite da dovod vazduha na mašini za sušenje bude otvoren i dobro provetren.*
- Udaljite potencijalne izvore plamena od mašine za sušenje.*

3.2 Skidanje sigurnosne zaštite za transport

 **UPOZORENJE**



- Uklonite sigurnosnu zaštitu za transport pre prve upotrebe ovog proizvoda.
- Ako se smer otvaranja vaših vrata na uređaju može menjati, pogledajte uputstva za montiranje reverzibilnih vrata.

3.3 Spajanje na odvod

Možete direktno da pošaljete skupljenu vodu kroz dostavljeno crevo za odvod vode umesto da povremeno praznite vodu sakupljenu u rezervoaru za vodu.

Spajanje creva za odvod vode

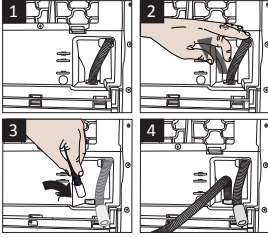

1-2 Povucite crevo na zadnjoj strani mašine za sušenje rukom da biste ga odvojili na mestu na kojem je povezano. Nemojte da koristite nikakve alate za skidanje creva.

- 3** Priključite jedan kraj creva za odvod priloženog uz mašinu za sušenje na priključak sa kog ste uklonili crevo proizvoda u prethodnom koraku.
- 4** Drugi kraj creva spojite direktno na odvod za vodu ili ga stavite u lavabo.

 **NAPOMENA**

- Crevo za odvod vode treba da se priključi maksimalno na visinu od 80 cm.
- Pazite da se crevo za odvod vode ne gazi i da se ne savija između odvoda i mašine.
- Ako je sa vašim proizvodom dostavljeno pakovanje sa dodacima, pogledajte detaljan opis.

3.4 Podešavanje nožica

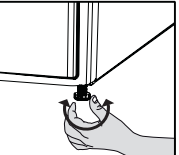

- Nožice okrećite na levo ili desno da biste podesili da mašina stoji u ravnoteži i čvrsto.

3.5 Transport mašine za sušenje veša

Ispustite svu vodu koja je preostala u mašini za sušenje veša.

Ako je uspostavljena direktna veza za odvod vode, uklonite priključke creva.



UPOZORENJE

- Preporučujemo da mašinu za sušenje veša prenosite u uspravnom položaju. Ako mašinu nije moguće nositi u uspravnom položaju, preporučujemo da je nosite nagnutu na desnu stranu gledano spreda.

3.6 Upozorenja o zvucima



NAPOMENA

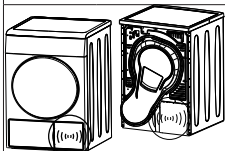

- Normalno je da se povremeno čuje škripanje tokom rada kompresora.

- Voda koja je prikupljena tokom rada pumpa se u rezervoar za vodu. Normalno je da se čuje šum pumpanja tokom ovog procesa.

3.7 Promena lampice za osvetljenje

U slučaju da se u vašoj mašini za sušenje veša koristi lampica za osvetljenje. Da bi promenili svetilju/LED koja se koristi za osvetljenje u vašoj mašini za sušenje, nazovite Ovlašćeni servis. Lampice koje se koriste u ovom uređaju nisu pogodne za osvetljenje soba kod kuće. Ova lampica je namenjena pomoći korisniku kod postavljanja veša u mašinu za sušenje na udoban način. Lampe koje su korišćene u ovom uređaju moraju biti u stanju da izdrže ekstremne fizičke uslove, kao što su vibracije i temperature iznad 50 °C

4 Priprema

4.1 Veš koji može da se suši u mašini za sušenje veša

Uvek se pridržavajte uputstava navedenim na etiketama odeće. Sušite samo veš na čijoj etiketi je navedeno da je pogodan za sušenje u mašini za sušenje veša.

4.2 Veš koji ne može da se suši u mašini za sušenje veša



Artikli sa ovim simbolom se ne smeju sušiti u mašini za sušenje veša.



NAPOMENA

- Osetljive tkanine, vuna, svila, delikatne i vredne tkanine, nepropusne tkanine i zavese od tila nisu pogodni za sušenje u mašini.

4.3 Priprema veša za sušenje

- Veš može međusobno da se zaplete posle pranja. Razdvojite veš pre nego što ga stavite u mašinu za sušenje.
- Sušite odeću sa metalnim delovima kao što su rasjferšlusi, okrenutu.
- Zatvorite rasjferšluse, kuke i šnale kao i dugmad.

4.4 Šta treba uraditi da se uštedi energija

- Kada perete veš, centrifugirajte ga najvećom mogućom brzinom. Stoga, vreme sušenja se skraćuje a potrošnja energije smanjuje.
- Sortirajte veš u zavisnosti od vrste i debljine. Sušite istu vrstu veša zajedno. Na primer, tanke kuhinjske krpe i peškiri se suše brže od debljih peškira za kupatilo.
- Pratite uputstva iz priručnika za korisnike u vezi sa izborom programa.
- Ne otvarajte vrata za punjenje mašine tokom sušenja osim ako je to neophodno. Ako morate da otvorite vrata za punjenje, pazite da ih ne ostavljate otvorena duže vreme.
- Nemojte da dodajete vlažan veš dok je mašina za sušenje u radu.

- Za modele sa kondenzatorom: čistite kondenzator jednom mesečno ili redovno nakon svakih 30 korišćenja.
- Povremeno čistite filter kada na njemu postoji vidljivo gomilanje vazduha ili kada se upali simbol, ukoliko na fioci sa filterom postoji simbol za upozorenje na čišćenje.
- Za modele sa dimnjakom: pridržavajte se uputstava za povezivanje dimnjaka i čistite ga.
- Tokom procesa sušenja dobro provetravajte prostoriju u kojoj se koristi vaša mašina za sušenje veša.

4.5 Odgovarajući kapacitet punjenja

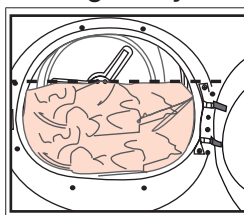

Pratite uputstva koja su navedena u „Tabeli programa i potrošnje”. Ne stavljajte više veša od vrednosti kapaciteta koje su navedene u tabeli.

Sledeće težine su navedene kao primeri.

Veš	Prosečne težine (gr)*	Veš	Prosečne težine (gr)*
Presvlake za jorgan (duple)	1500	Bluze	150
Presvlake za jorgan (obične)	1000	Pamučne košulje	300
Čaršavi (dupli)	500	košulje	250
Čaršavi (obični)	350	Pamučne haljine	500
Veliki stolnjaci	700	Haljine	350
Mali stolnjaci	250	Džins	700
Salvete	100	Maramice (10 komada)	100
Peškiri za kupanje	700	Majice	125
Peškiri za ruke	350		

* Težina veša za sušenje pre pranja.

5 Rukovanje proizvodom

5.1 Kontrolni panel

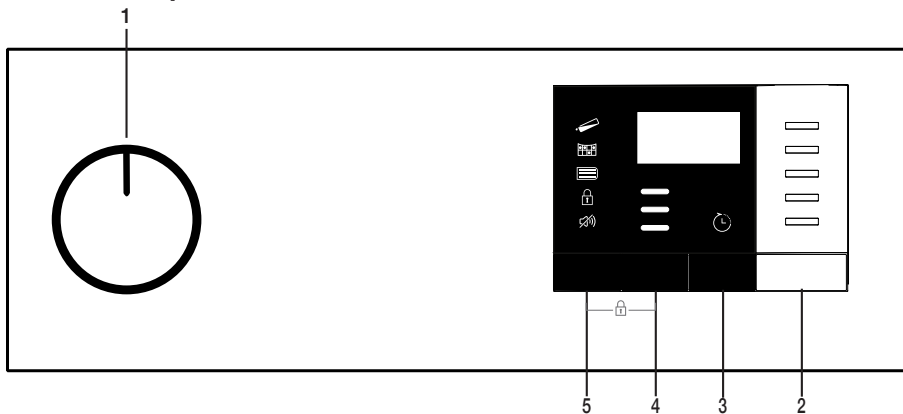

1. Dugme za uključivanje/isključivanje/ biranje programa
2. Dugme za pokretanje/pripravnost
3. Dugme za završetak
4. Dugme za nivo sušenja
5. Dugme za jačinu zujalice / biranje vremenskih programa

5.2 Simboli



5.3. Priprema mašine za sušenje

- Prikjučite mašinu za sušenje.
- Otvorite vrata za punjenje mašine.
- Stavite veš za sušenje u mašinu tako da se ne zaglavi.
- Gurnite i zatvorite vrata za punjenje mašine.

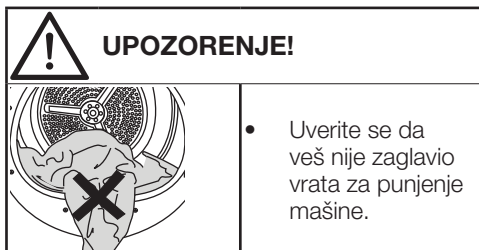

Izaberite željeni program pomoću dugmeta za uključivanje/isključivanje/biranje programa, mašina će se uključiti.



NAPOMENA

- Izbor programa pomoću dugmeta za uključivanje/isključivanje/izbor programa ne znači da će program početi. Pritisnite dugme Pokretanje/pripravnost da biste pokrenuli program.

5.4 Izbor programa i tabela potrošnje

SB				
Programi	Opis programa	Kapacitet (kg)	Brzina centrifuge u mašini za pranje veša (o/min)	Vreme sušenja (minut)
Pamuk Spremno za peglanje	Jednoslojne ležerne pamučne tkanine suše se tako da ostanu malo vlažne i da budu spremne za peglanje.	8	1000	145
Pamuk Eko	Jednoslojne ležerne pamučne tkanine suše se na najekonomičniji mogući način.	8	1000	197
Pamuk Spremno za nošenje	Ovaj program možete koristiti za dodatnu suvoču debelog rublja, kao što su pantalone, trenerke. Možete da stavite odeću u orman bez peglanja.	8	1000	210
Pamuk Veoma suvo	Na ovom ciklusu se suše višeslojne ili debele pamučne tkanine koje su otporne na toplotu i teško se suše.	8	1000	220
Sintetika Spremno za peglanje	Na ovom ciklusu možete da sušite sintetičke tkanine do nivoa pogodnog za peglanje tako što ćete ih ostaviti malo vlažnim da budu praktičnije za peglanje.	4	800	60
Sintetika Spremno za nošenje	Na ovom ciklusu možete sušiti sve vaše sintetičke tkanine. Možete nasložiti vaš veš u ormar bez peglanja.	4	800	70
Sušilica / vremensko sušenje	Možete da birate između vremenskih programa od 10 do 160 minuta da biste postigli željeni nivo sušenja na niskoj temperaturi. Na ovom programu rad mašine za sušenje traje tokom postavljenog vremena, nezavisno od suvoče veša. Ovaj proizvod je dostupan za korišćenje sa korpom za sušenje kao opcijom. Za proizvode koji se prodaju bez korpe, možete da nabavite korpu od ovlašćenog servisa i koristite programe sušenja navedene iznad. Za detalje upotrebe pogledajte korisnički vodič za korpu za sušenje.	-	-	-
Osveživač (Osveživač Vune)	Ventiliše 10 minuta bez duvanja toplog vazduha. Ovim programom možete provetriti pamučnu i platnenu odeću koja je dugo vremena stajala zatvorena kako bi uklonili ustajali miris. Ovaj program možete koristiti za provetranje i omekšavanje vunениh tkanina koje je dozvoljeno prati u mašini za pranje veša. Ne koristiti za potpuno sušenje.	-	-	10
Osetljivo / Košulja	Suši košulje na osetljiviji način i dovodi do manjeg gužvanja i lakšeg peglanja.	2	1200	50
Džinsy	U ovom programu možete sušiti pantalone, suknje, košulje i jakne od teksasa.	4	1200	140
Odeća za spoljašnje uslove/sportska odeća (Goretex)	Koristite ga za sušenje odeće od sintetičkih, pamučnih ili mešanih tkanina ili vodonepropusnih proizvoda, kao što su funkcionalna jakna, kišni mantil itd. Pre sušenja, odeću okrenite naopako.	2	1000	130

Pomesati(Dnevni)	Možete da sušite i pamučni i sintetički veš na ovom programu.Ovim programom se može sušiti sportska odeća i odeća za fitness.	4	1000	125
Higijena (BabyProtect+)	Ovo je duži program koji možete da koristite za odeću (odeću za bebe, peškire, donji veš itd.) koja zahteva higijenu. Higijena se obezbeđuje visokom temperaturom ((Ovaj program je identifikovan i odobren od strane Engleske Britanske Fondacije " The British Foundation" (Allergy UK).))	5	800	195
Perje	Svoju odeću, kao što su kaputi, perjane i mikrofiber jakne možete sušiti ako na sebi imaju etiketu da se mogu sušiti u mašini za sušenje veša. Sušiti okrenuto naopako.	-	800	100
Ekspresno 30'	Koristiti ovaj program kako biste imali 2 stvari spremne za peglanje.	0,5	1200	30

Vrednosti potrošnje energije

Programi	Kapacitet (kg)	Brzina centrifuge u mašini za pranje veša (o/min)	Približna količina preostale vlage	Potrošnja energije kWh
Pamuk Eko*	8	1000	60%	2,47
Pamuk Spretno za peglanje	8	1000	60%	2,10
Sintetika Spretno za nošenje	4	800	40%	0,80
	„Program Pamuk Eko“, koji se koristi za puno i delimično punjenje, je standardni program za sušenje na koji se odnose informacije na etiketi i u dokumentaciji, i prikladan je za sušenje normalno vlažnog pamučnog veša, a predstavlja najefikasniji program u pogledu potrošnje energije za sušenje pamučnog veša.			

* : Energetska nalepnica za standardni program (EN 61121:2012) Sve vrednosti u tabeli se utvrđuju u skladu sa standardom EN 61121:2012 standard. Vrednosti potrošnje mogu da variraju od vrednosti u tabeli u zavisnosti od vrste veša, brzine ceđenja, uslova okoline i nivoa napona.



Allergy UK je brend Britanske Asocijacije Alergija. Pečat Odobrenja je kreiran da vodi osobe koje zahtevaju predloge i savete o proizvodu kojeg određeni proizvod ograničava/ redukuje/ eliminiše alergente i značajno smanjuje prisustvo alergena u ambijentu gde postoje pacijenti sa alergijama. Za cilj ima da omoguću naučno testirane proizvode ili proizvode ispitane na način da daju merljive rezultate.

5.5 Pomoćne funkcije Zujalica/vreme

Mašina za sušenje pravi zvuk upozorenja kada se program završi. Ako ne želite zvučno upozorenje na mašini, pritisnite dugme Zujalica/vreme. Kada pritisnete dugme Zujalica/vreme, nakon završetka programa će zasvetleti lampica bez zvučnog upozorenja.



NAPOMENA

- Možete da izaberete ovu funkciju pre ili posle pokretanja programa.

Dugme Zujalica/vreme koristi se za podešavanje trajanja programa kada se biraju programi Rek/time.

Nivo sušenja

Dugme za nivo sušenja se koristi za podešavanje željenog nivoa sušenja. Trajanje programa se može promeniti u zavisnosti od izbora.



NAPOMENA

- Ovu funkciju možete da aktivirate isključivo pre početka programa.

Završetak

Možete da odložite vreme završetka programa do 24 časa pomoću funkcije Vreme završetka.

1. Otvorite vrata za punjenje i stavite veš.
2. Izaberite program sušenja.
3. Pritisnite dugme za izbor završetka i podesite kašnjenje koje želite. LED lampica za vreme završetka će svetleti. (Kada se dugme pritisne i drži, vreme završetka se produžava na non-stop).
4. Pritisnite dugme Pokretanje/pripravnost. Odbrojavanje za vreme završetka počinje. „:” Separator na sredini prikazanog vremena odlaganja treperi.



NAPOMENA

- Možete dodati ili ukloniti veš na kraju. Prikazano vreme je zbir normalnog vremena sušenja i vremena završetka. LED lampica za kraj vremena će se isključiti na kraju odbrojavanja, sušenje počinje i LED lampica za sušenje će zasvetleti.

Promena vremena završetka

Ukoliko želite da promenite trajanje tokom odbrojavanja:

Otkazite program okretanjem dugmeta za uključivanje/isključivanje/biranje programa. Izaberite željeni program i ponovite proces izbora vremena završetka.

Otkazivanje funkcije vremena završetka
Ako želite da otkazete odbrojavanje vremena završetka i odmah pokrenete program:

Otkazite program okretanjem dugmeta za uključivanje/isključivanje/biranje programa. Izaberite željeni program i pritisnite dugme Pokretanje/pripravnost.

5.6 Indikatori upozorenja



NAPOMENA

- Indikatori upozorenja mogu da variraju u zavisnosti od modela mašine za sušenje veša.

Čišćenje filtera

Kada se program završi, uključice se indikator upozorenja za čišćenje filtera.

Rezervoar za vodu

Ako se rezervoar za vodu napuni dok je program u toku, indikator za upozorenje počinje da treperi i mašina ide u režim pripravnosti. U tom slučaju ispraznite vodu iz rezervoara i pokrenite program pritiskom na dugme Pokretanje/pripravnost. Indikator upozorenja se isključuje i program nastavlja sa radom.

Čišćenje filtera mašine za sušenje veša / Izmenjivača toplote

Kada se program završi, može zasvetleti simbol za čišćenje izmenjivača toplote ili filtera.

5.7 Pokretanje programa

Pritisnite dugme Pokretanje/pripravnost da biste pokrenuli program.

Indikator Pokretanje/pripravnost i Sušenje svetleće da naznače da je program počeo.

5.8 Zaključavanje zbog dece

Mašina ima zaštitu od dece koja sprečava da tok programa bude prekinut kada se stisnu dugmad u toku programa. Kada se aktivira zaštita od dece, sva dugmad na panelu se onemogućavaju osim dugmeta za uključivanje/isključivanje/biranje programa.

Istovremeno pritisnite dugme za Nivo sušenja i Zujalica 3 sekunde da biste aktivirali zaštitu od dece.

Zaključavanje zbog dece treba da se deaktivira da biste mogli da započnete novi program nakon što je tekući program završen ili da biste mogli da promenite program. Za deaktivaciju zaštite od dece, zadržite istu dugmad 3 sekunde.



NAPOMENA

- Kada se zaštita od dece aktivira, na ekranu se uključuje indikator upozorenja na zaštitu od dece.
- Zaštita od dece se deaktivira kada se mašina za sušenje isključi i ponovo uključi pomoću dugmeta za Uključivanje/Isključivanje/Otkazivanje.



NAPOMENA

- Kada mašina za sušenje veša radi a zaštite od dece je aktivna, zvučni signal će se oglasiti dva puta kada se okrene dugme za izbor programa. Ako je zaštita od dece deaktivirana bez vraćanja dugmeta za izbor programa u prethodni položaj, program će se završiti usled promene položaja dugmeta za izbor programa.

5.9 Promena programa nakon što je počeo

Možete promeniti izabrani program za sušenje veša i izabrati drugi program nakon što je mašina za sušenje veša počela da radi

- Na primer, izaberite program za Dodatno sušenje okretanjem dugmeta za Uključivanje/Isključivanje/Izbor programa za izbor Dodatnog sušenja umesto Suvo za peglanje.
- Pritisnite dugme Pokretanje/pripravnost da biste pokrenuli program.

Dodavanje i uklanjanje veša tokom pripravnosti

Ako želite da dodate ili uklonite veš nakon početka programa sušenja:

- Pritisnite dugme Pokretanje/pripravnost da prebacite mašinu za sušenje veša u režim pripravnosti. Operacija sušenja se zaustavlja.
- Otvorite vrata za punjenje mašine dok je u stanju pripravnosti i zatvorite vrata nakon dodavanja ili vađenja veša.
- Pritisnite dugme Pokretanje/pripravnost da biste pokrenuli program.



NAPOMENA

- Dodavanje veša posle početka operacije sušenja može izazvati mešanje osušenog i mokrog veša unutar mašine i veš može ostati vlažan nakon sušenja.



NAPOMENA

- Dodavanje ili uklanjanje veša tokom sušenja možete ponoviti koliko god puta želite. Ali ta operacija neprekidno prekida operaciju sušenja, što produžava trajanje programa i povećava potrošnju energije. Dakle, preporučljivo je da dodate veš pre početka programa.
- Ako izaberete novi program okretanjem dugmeta za izbor programa dok je mašina za sušenje veša u režimu pripravnosti, trenutni program će se prekinuti.



UPOZORENJE!

- Ne dodirujte unutrašnju površinu bubnja prilikom dodavanja ili uklanjanja veša tokom tekućeg programa. Površina bubnja je vruća.

5.10 Otkazivanje programa

Ako želite da otkazete program i da prekinete operaciju sušenja iz bilo kog razloga nakon što mašina za sušenje veša počne sa radom, pritisnite dugme za Uključivanje/Isključivanje/Otkazivanje i program će biti otkazan.



UPOZORENJE!

- Unutrašnjost mašine za sušenje veša može biti veoma vruća kada otkazete program, stoga osvežite program da bi se ohladila.

5.11 Kraj programa

Kada se program završi, LED lampice za upozorenje Poslednje/protiv gužvanja i Čišćenje filtera vlakana na programu će zasvetleti. Vrata za punjenje se mogu otvoriti i mašina za sušenje postaje spremna za novi ciklus rada. Postavite dugme za Uključivanje/Isključivanje/Izbor programa u položaj Uključeno/Isključeno da biste isključili mašinu za sušenje veša.



NAPOMENA

- Ako ne uklonite veš nakon završetka programa, funkcija za sprečavanje gužvanja veša se aktivira na 2 sata radi sprečavanja gužvanja veša unutar mašine. Program okreće veš u intervalima od 10 minuta radi sprečavanja gužvanja veša.

6 Održavanje i čišćenje

6.1 Unutrašnje površine vrata za punjenje mašine

Đlake i vlakna koji se izdvajaju iz veša tokom procesa sušenja prikupljaju se u filteru vlakana.



NAPOMENA

- Vlakna se formiraju tokom nošenja i pranja odeće.
- Kućište filtera možete očistiti usisivačem.



UPOZORENJE!

- Nakon svakog ciklusa sušenja, očistite filter vlakna i unutrašnju površinu vrata za punjenje.

Za čišćenje filtera:

- Otvorite vrata za punjenje mašine.
- Držite prvi deo (unutrašnji filter) dvodelnog filtera za vlakna i uklonite ga tako što ćete ga povući nagore.
- Prikupite đlake, vlakna i pamučne loptice rukom ili mekom krpom.
- Uklonite drugi deo (spoljašnji filter) povlačenjem nagore.

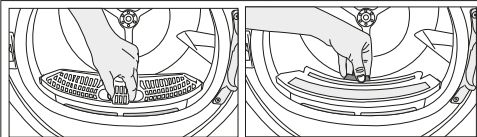

NAPOMENA

- Postarajte se da đlake, vlakna i pamučne loptice ne padnu u kućište gde se filteri instaliraju.

Otvorite oba filtera (gornji i donji) i rukom uklonite vlakna, ili koristite četku za čišćenje na poklopcu za usmeravanje vazduha. A ako je potrebno, koristite usisivač za čišćenje filtera.

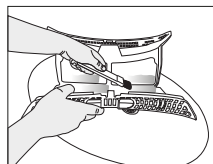
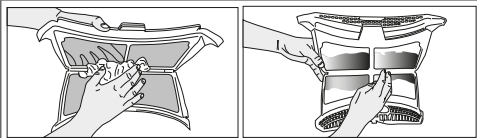

- Očistite oba filtera pod vodom koja teče u smeru suprotnom od nakupljanja vlakana ili korišćenjem meke četke. Osušite filter pre vraćanja.

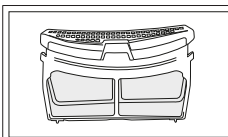
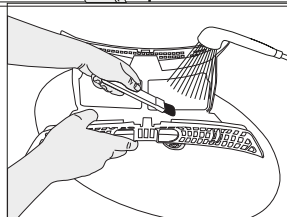
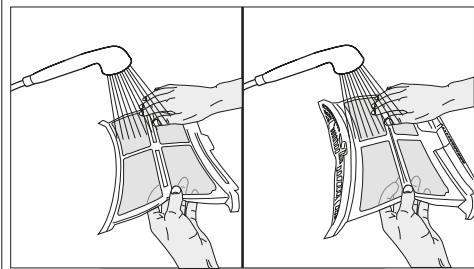

- Ubacite filtere za vlakna jedna na drugi i vratite ih na mesto.

- Očistite unutrašnju površinu prednjih vrata i zaptivke istim mekom vlažnom krpom ili četkom na poklopcu za usmeravanje vazduha

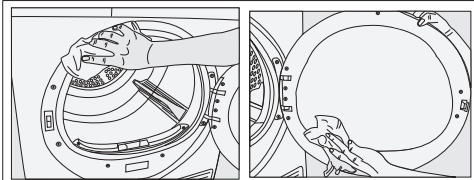

6.2 Čišćenje senzora

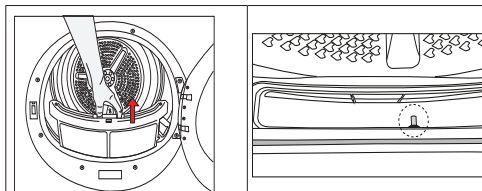

- U mašini za sušenje veša postoji senzor temperature koji otkriva da li je veš suv. Da biste očistili senzor:
- Otvorite vrata za punjenje mašine za sušenje veša.
- Uklonite filter za dlačice tako što ćete ga povući nagore.
- Senzor očistite rukama ako na njemu ima nakupljenog paperja.



NAPOMENA

- Čistite metalne površine senzora 4 puta godišnje.
- Nemojte da koristite alate kada čistite metalne površine senzora.
- Ostavite mašinu da se ohladi ako je još uvek vruća zbog procesa sušenja.



UPOZORENJE!

- Nikada ne koristite rastvarače, sredstva za čišćenje ili slične supstance za čišćenje zbog rizika od požara i eksplozije!

6.3 Pražnjenje rezervoara za vodu

Tokom procesa sušenja se uklonjena vlaga iz veša kondenzuje, a voda koja se stvara se akumulira u rezervoar za vodu. Ispraznite rezervoar za vodu nakon svakog ciklusa sušenja.



UPOZORENJE!

- Kondenzovana voda nije za piće!
- Nikada ne uklanjajte rezervoar za vodu dok je program u toku!

Ako zaboravite da ispraznite rezervoar za vodu, mašina će se tokom sledećih ciklusa sušenja zaustaviti ako se rezervoar za vodu napuni,

a simbol upozorenja na rezervoar za vodu će početi da treperi. Ako je to slučaj, ispraznite rezervoar za vodu i pritisnite dugme Pokretanje/pauza da biste nastavili ciklus sušenja. Za pražnjenje rezervoara za vodu:

1. Pažljivo izvadite rezervoar za vodu iz fiok e ili posude.

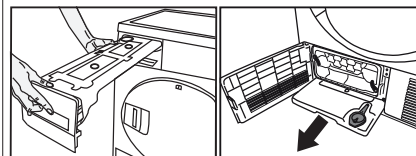

2. Izbacite vodu iz rezervoara.

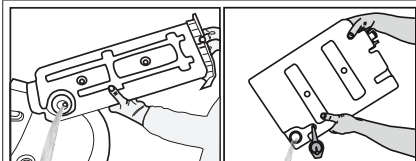

- Ako su se nakupile dlačice u levku rezervoara za vodu, očistite ga pod mlazom vode.
- Rezervoar za vodu vratite na mesto.



NAPOMENA

- Ako se kao opcija koristi direktno ispuštanje vode, nema potrebe za pražnjenjem rezervoara za vodu.

6.4 Čišćenje kondenzatora.

Mala količina vlakna može proći kroz filter za vlakna i sakupljati se na metalnoj površini kondenzatora.

Metalnu površinu kondenzatora treba redovno čistiti.

Ako ikona isparivača treperi na ekranu, proverite metalnu površinu kondenzatora. Ako je prijav, očistite ga. Ovaj deo treba proveriti najmanje jednom u 6 meseci.

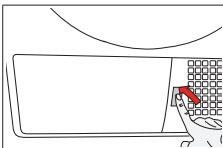

- Otvorite donju ploču tako što ćete je pritisnuti.

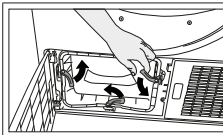

- Da biste otvorili vrata za prolazak vazduha, pomerite bravicu za oslobađanje.

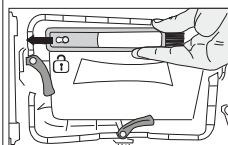

- Potiahnete kefu smerom doľava a vyberte ho. Čistiacu kefu môžete použiť na odstránenie nahromadeného páperia na kovovom povrchu kondenzátora.

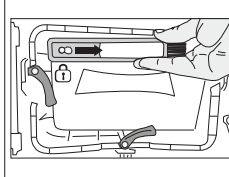

- Umetnite četku u njen otvor gurajući udesno, nakon što očistite kondenzator, prednji poklopac i filter za vlakna.



NAPOMENA

- Četka se nalazi u vrećici sa đtampanim materijalima. Možete je staviti u njeno kućište na poklopac za usmeravanje vazduha nakon prve upotrebe.

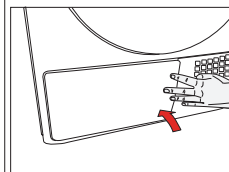

- Nakon što se proces čišćenja završi, stavite vrata za prolazak vazduha na mesto, pomerite bravice da ih zatvorite i zatvorite donju ploču.

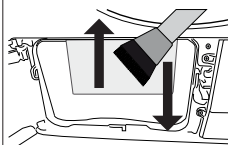

- Nakupljene dlačice na površini kondenzatora treba ukloniti vlažnom krpom ili pokretima četke postavljene na poklopcu za usmeravanje nagore i nadole na kondenzatoru.

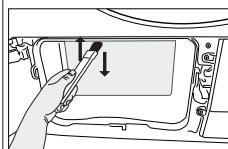

- Nemojte čistiti rebra kondenzatora udesno-levo kako biste izbegli oštećenja.
- Za čišćenje možete koristiti i usisivač sa četkom. Čišćenje kondenzatora se ne preporučuje sa usisivačem bez četkica. .



UPOZORENJE!

- Možete čistiti rukom pod uslovom da nosite zaštitne rukavice. Ne pokušavajte da čistite golim rukama. Možete povrediti ruku na krilcima kondenzatora. Čišćenjem pokretima s leva nadesno možete oštetiti krilca kondenzatora. To može da dovede do problema sa sušenjem.

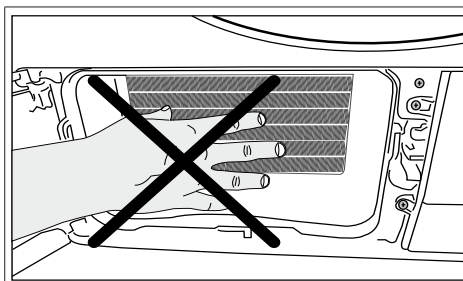

UPOZORENJE!

- Normalno je ako uočite malo vode na plastičnoj površini ispred kondenzatora kada otvorite poklopac za usmeravanje vazduha.

7 Rešavanje problema

Sušenje traje previše dugo.

Pore filtera za vlakna su možda začepljene. >>> Operite filter toplom vodom.
Fioka sa filterom je možda začepljena. >>> Očistite sunder i krpu filtera (ako je prisutna) u fioci filtera. (za proizvode sa pumpom za grejanje)
Kondenzator je možda blokiran. >>> Operite kondenzator. (za proizvode sa kondenzatorom)
Ventilacione rešetke sa prednje strane mašine su možda zatvorene. >>> Uklonite sve predmete koji se nalaze ispred ventilacionih rešetki koji blokiraju vazduh.
Ventilacija možda nije prikladna jer je oblast u koju je instalirana mašina previše mala.
>>> Otvorite vrata ili prozore da sprečite da temperatura u prostoriji previše poraste.
Na senzoru vlage se može napraviti naslaga kamenca. >>> Očistite senzor vlage.
Možda je ubačena prekomerna količina veša.
>>> Nemojte prekomerno da puniti mašinu za sušenje veša.
Veš možda nije pravilno isceden. >>> Podesite brže ceđenje u mašini za pranje.

Odeća je vlažna nakon sušenja.

Možda je korišćen program koji nije pogodan za datu vrstu veša.>>> Proverite oznake za održavanje na odeći i izaberite program koji odgovara vrsti odeće ili primenite dodatne vremenske programe.
Pore filtera za vlakna su možda začepljene. >>> Operite filter toplom vodom.
Kondenzator je možda blokiran. >>> Operite kondenzator. (za proizvode sa kondenzatorom)
Fioka sa filterom je možda začepljena. >>> Očistite sunder i krpu filtera (ako je prisutna) u fioci filtera. (za proizvode sa pumpom za grejanje)
Možda je ubačena prekomerna količina veša.
>>> Nemojte prekomerno da puniti mašinu za sušenje veša.
Veš možda nije pravilno isceden. >>> Podesite brže ceđenje u mašini za pranje.

Mašina za sušenje se ne pokreće ili se program ne može pokrenuti. Mašina za sušenje se ne pokreće nakon što je konfigurisana.

Strujni utikač je možda isključen iz utičnice. >>> Proverite da li je kabl za napajanje uključen u struju.
Vrata za punjenje su možda otvorena. >>> Postarajte se da vrata za punjenje budu pravilno zatvorena.
Program možda nije podešen ili dugme Start/Mirovanje možda nije pritisnuto. >>> Proverite da li je program podešen i da li nije u položaju Mirovanje.
Zaključavanje zbog dece je možda aktivirano. >>> Isključite zaključavanje zbog dece.

Program je bez razloga prerano završen.

Vrata za punjenje možda nisu u potpunosti zatvorena. >>> Postarajte se da vrata za punjenje budu potpuno zatvorena.
Možda je došlo do prekida dotoka struje. >>> Pritisnite dugme Start/Mirovanje da pokrenete program.
Rezervoar za vodu je možda pun. >>> Ispraznite rezervoar za vodu.

Odeća se smanjila, stvrdnula ili je uništena.

Možda je korišćen program koji nije pogodan za datu vrstu veša.>>> Proverite oznake za održavanje na odeći i izaberite program koji odgovara datoj vrsti odeće.

Svetlo unutar mašine za sušenje se ne uključuje. (Za modele sa lampom)

Mašina za sušenje možda nije uključena pritiskom na dugme za uključivanje/ isključivanje ili program možda nije izabran za mašine bez dugmeta za uključivanje/ isključivanje. >>> Proverite da li je mašina za sušenje uključena.
Lampa možda nije ispravna. >>> Obratite se ovlašćenom servisu za zamenu lampe.

Simbol / LED lampica za čišćenje filtera su uključeni / trepere.

Filter za vlakna možda nije očišćen. >>> Očistite filter.
Prerez za filter je možda začepljen dlačicama. >>> Očistite prerez za filter.
Sloj vlakana se možda nakupio i začepljuje pore filtera za dlačice. >>> Operite filter toplom vodom.
Kondenzator je možda blokiran. >>> Operite kondenzator.

Voda kaplje sa vrata za punjenje.
Vlakna su se možda nakupila sa unutrašnjih strana vrata za punjenje i u korpi za punjenje veša. >>> Očistite unutrašnje površine vrata za punjenje i površine korpe vrata za punjenje.
Vrata za punjenje se samostalno otvaraju.
Vrata za punjenje možda nisu potpuno zatvorena. >>> Gurajte vrata za punjenje dok se ne začuje zvučni signal za zatvaranje.
Simbol / LED lampica za upozorenje na rezervoar za vodu su uključeni / trepere.
Rezervoar za vodu je možda pun. >>> Ispraznite rezervoar za vodu. Crevo za izbacivanje vode je možda neispravno. >>> Ako je proizvod direktno povezan sa odvodom vode, proverite crevo za izbacivanje vode.
Simbol pare treperi. (Za proizvode sa funkcijom pare)
Rezervoar za paru je možda prazan => Napunite rezervoar za paru destilovanom ili kondenzovanom vodom.
Programi sa parom se ne pokreću (za proizvode sa funkcijom pare)
Rezervoar za paru je možda prazan, ikonica upozorenja za rezervoar za paru može da zasvetli na ekranu => Napunite rezervoar za paru dok se ikonica za paru ne isključi.
Nabori nisu uklonjeni programom za uklanjanje nabora. (Za proizvode sa funkcijom pare)
Možda je ubačena prekomerna količina veša => Ubacite naznačenu količinu veša. Možda je vreme za primenu pare izabrano na niskom nivou => Izaberite program sa velikom količinom pare. Nakon završetka programa veš je možda dugo ostao u mašini => Izvadite veš čim se program završi i okačite ga.
Neprijatan miris iz veša nije umanjen programom za uklanjanje neprijatnih mirisa. (Za proizvode sa programom za uklanjanje neprijatnih mirisa)
Možda je ubačena prekomerna količina veša => Ubacite naznačenu količinu veša. Možda je vreme za primenu pare izabrano na niskom nivou => Izaberite program sa velikom količinom pare.



UPOZORENJE

- Ako se problem ne otkloni nakon praćenja uputstava iz ovog odeljka, obratite se prodavcu ili ovlašćenom servisu. Nikada nemojte da pokušavate da sami popravite proizvod.



NAPOMENA

- U slučaju da nađete na probleme kod bilo kog dela svog uređaja, možete da zatražite zamenu proizvoda tako što ćete se obratiti ovlašćenom servisu i priložiti broj modela uređaja.
- Korišćenje uređaja sa neoriginalnim delovima može dovesti do kvara uređaja.
- Proizvođač i prodavac nisu odgovorni za kvarove izazvane korišćenjem neoriginalnih delova.

TEHNIČKI LIST PROIZVODA

U skladu sa Uredbom koju je izdala komisija (EU) br.: 392/2012

Naziv dobavljača ili robna marka		BEKO
Naziv modela		DS8312PX 7188235080
Ocena kapaciteta (kg)		8,0
Tip mašine za sušenje veša	Izdovna	-
	Kondenzator	•
Klasa energetske efikasnosti ⁽¹⁾		A+
Godišnja potrošnja energije (kWh) ⁽²⁾		297,0
Vid kontrole	Automatski	•
	Neautomatski	-
Potrošnja energije kod standardnog programa za pamuk pri maksimalnom punjenju (kWh)		2,47
Potrošnja energije kod standardnog programa za pamuk pri delimičnom punjenju (kWh)		1,35
Potrošnja energije u režimu isključeno za standardni program za pamuk pri maksimalnom punjenju, P ₀ (W)		0,50
Potrošnja energije u režimu uključeno za standardni program za pamuk pri maksimalnom punjenju, P ₁ (W)		1,00
Trajanje režima uključeno (min)		30
Standardni program za pamuk ⁽³⁾		•
Vreme za standardni program za pamuk pri maksimalnom punjenju, T _{day} (min)		197
Vreme za standardni program za pamuk pri delimičnom punjenju, T _{day1/2} (min)		115
Procenjeno programsko vreme za standardni program za pamuk pri maksimalnom i delimičnom punjenju (T ₁)		150
Klasa efikasnosti kondenzacije ⁽⁴⁾		B
Prosečna efikasnost kondenzacije kod standardnog programa za pamuk pri delimičnom punjenju C _{day}		81%
Prosečna efikasnost kondenzacije kod standardnog programa za pamuk pri delimičnom punjenju, C _{day1/2}		81%
Procenjena efikasnost kondenzacije kod standardnog programa za pamuk pri maksimalnom i delimičnom punjenju, C ₁		81%
Nivo zvučne snage standardnog programa za pamuk pri maksimalnom punjenju ⁽⁵⁾		65
Ugrađeno		-

• : Da - : Ne

(1) Skala od A+++ (najefikasnije) do D (najmanje efikasno)

(2) Potrošnja energije na osnovu 160 okretaja sušenja za standardni program za pamuk pri maksimalnom i delimičnom punjenju i potrošnja u režimu smanjene potrošnje. Stvarna potrošnja energije po okretaju zavisiće od toga kako se aparat koristi.

(3) „Program za sušenje pamuka bez peglanja“ korišćen za maksimalno i delimično punjenje, standardni je program za sušenje na koji se odnose podaci na nalepnici i tehničkom listu, što znači da je ovaj program pogodan za sušenje normalno vlažnog pamučnog veša i najefikasniji je program za pamuk u pogledu potrošnje energije.

(4) Skala od G (najmanje efikasno) do A (najefikasnije)

(5) Procenjena prosečna vrednost —L_{WA} izražena u dB(A) u odnosu na 1 pW

Ovaj dokument je originalno proizveden i objavljen od strane proizvođača, brenda Beko, i preuzet je sa njihove zvanične stranice. S obzirom na ovu činjenicu, Tehnoteka ističe da ne preuzima odgovornost za tačnost, celovitost ili pouzdanost informacija, podataka, mišljenja, saveta ili izjava sadržanih u ovom dokumentu.

Napominjemo da Tehnoteka nema ovlašćenje da izvrši bilo kakve izmene ili dopune na ovom dokumentu, stoga nismo odgovorni za eventualne greške, propuste ili netačnosti koje se mogu naći unutar njega. Tehnoteka ne odgovara za štetu nanесenu korisnicima pri upotrebi netačnih podataka. Ukoliko imate dodatna pitanja o proizvodu, ljubazno vas molimo da kontaktirate direktno proizvođača kako biste dobili sve detaljne informacije.

Za najnovije informacije o ceni, dostupnim akcijama i tehničkim karakteristikama proizvoda koji se pominje u ovom dokumentu, molimo posetite našu stranicu klikom na sledeći link:

<https://tehnoteka.rs/p/beko-masina-za-susenje-vesa-ds-8312-px-akcija-cena/>