

Uputstvo za upotrebu

AEG ugradna rerna BPB351160M

AEG



Tehnoteka je online destinacija za upoređivanje cena i karakteristika bele tehnike, potrošačke elektronike i IT uređaja kod trgovinskih lanaca i internet prodavnica u Srbiji. Naša stranica vam omogućava da istražite najnovije informacije, detaljne karakteristike i konkurentne cene proizvoda.

Posetite nas i uživajte u ekskluzivnom iskustvu pametne kupovine klikom na link:

<https://tehnoteka.rs/p/aeg-ugradna-rerna-bpb351160m-akcija-cena/>

► SQ Udhëzimet për përdorim	2	SK Návod na používanie	405
BG Ръководство за употреба	38	SL Navodila za uporabo	440
HR Upute za uporabu	76		
CS Návod k použití	111		
ET Kasutusjuhend	146		
EL Οδηγίες Χρήσης	181		
HU Használati útmutató	219		
LV Lietošanas instrukcija	256		
LT Naudojimo instrukcija	292		
MK Упатство за ракување	329		
SR Упутство за употребу	367		

USER MANUAL

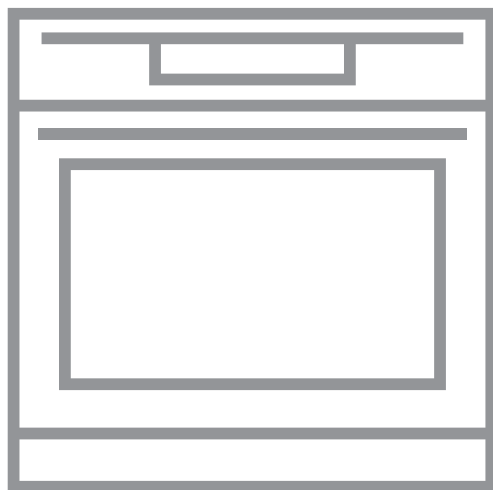

BPB351160M
BPS351160M

AEG

PËR REZULTATE PERFEKTE

Faleminderit që keni zgjedhur këtë produkt AEG. Ne e kemi krijuar atë për t'ju ofruar performancë të përsosur për shumë vite, me teknologji novatore që ndihmojnë në thjeshtimin e jetës - veçori që mund të mos i gjeni në pajisjet e zakonshme. Kushtojini pak minuta leximit për ta shfrytëzuar sa më mirë.

Vizitoni faqen tonë të internetit për:



Të marrë këshilla mbi përdorimin, broshura, informacion rreth zgjidhjes së problemeve, shërbimit dhe riparimit

www.aeg.com/support



Regjistroni produktin për shërbim më të mirë:

www.registreaeg.com



Blini aksesore, pjesë konsumi dhe pjesë origjinale këmbimi për pajisjen:

www.aeg.com/shop



Për më shumë receta, këshilla, diagnostikim problemesh, shkarkoni aplikacionin **My AEG Kitchen**.



KUJDESI DHE SHËRBIMI NDAJ KLIENTIT

Përdorni gjithmonë pjesë këmbimi origjinale.

Kur kontaktoni Qendrën tonë të Autorizuar të Shërbimit, sigurohuni që të keni në dispozicion të dhënat e mëposhtme: Modeli, PNC, numri serial.

Ky Informacioni mund të gjendet në pllakën e klasifikimit.

 Paralajmërim / Të dhëna rreth sigurisë dhe kujdesit

 Të dhëna të përgjithshme dhe këshilla

 Të dhëna rreth ambientit

Rezervohet mundësia e ndryshimeve.

PËRMBAJTJA

1. INFORMACIONI I SIGURISË.....	3	3. PËRSHKRIM I PRODUKTIT.....	9
1.1 Siguria e fëmijëve dhe personave me probleme.....	3	3.1 Pasqyra e përgjithshme.....	9
1.2 Siguria e përgjithshme.....	4	3.2 Aksesoret.....	10
2. UDHËZIMET PËR SIGURINË.....	5	4. SI TË NDEZIM DHE TË FIKIM FURRËN... 10	
2.1 Instalimi.....	5	4.1 Dorezat e palosshme.....	10
2.2 Lidhja elektrike.....	6	4.2 Paneli i kontrollit.....	11
2.3 Përdorimi.....	7	5. PËRPARA PËRDORIMIT TË PARË..... 12	
2.4 Kujdesi dhe pastrimi.....	7	5.1 Pastrimi fillestar.....	12
2.5 Pastrimi pirolitik.....	8	5.2 Ngrohja paraprake fillestare.....	12
2.6 Ndryçimi i brendshëm.....	8		
2.7 Shërbimi.....	9		
2.8 Eliminimi i pajisjes.....	9		

6. PËRDORIMI I PËRDITSHËM.....	12	10.3 Tabelat e gatimit për institutet e testimit.....	26
6.1 Si ta programoni: Funkzionet e nxehtjes.....	13	11. KUJDESI DHE PASTRIMI.....	28
6.2 Funkzionet e nxehtjes.....	13	11.1 Shënime mbi pastrimin.....	28
6.3 Shënime mbi: Pjekje vent. me lagështirë.....	15	11.2 Si ta pastroni: Zbalcim i brendshëm.....	29
6.4 Si ta programoni: Gatim i asistuar.....	15	11.3 Mënyra e heqjes: Mbajtëset e rafteve.....	29
6.5 Gatim i asistuar me receta.....	15	11.4 Si ta përdorni: Pastrimi pirolitik.....	29
7. FUNKSIONET E ORËS.....	21	11.5 Kujtuesi i pastrimit.....	31
7.1 Funkzionet e orës.....	21	11.6 Mënyra e heqjes dhe e instalimit: Dera.....	31
7.2 Si ta programoni: Funkzionet e orës.....	21	11.7 Mënyra e ndërrimit: Llamba.....	32
8. MËNYRA E PËRDORIMIT: AKSESORËT.....	23	12. ZGJIDHJA E PROBLEMEVE.....	32
8.1 Futja e aksesoreve.....	23	12.1 Çfarë duhet bërë nëse.....	33
9. FUNKSIONET SHITESË.....	24	12.2 Të dhëna për shërbimin.....	34
9.1 Kyçje.....	24	13. EFIKASITETI ENERGJETIK.....	34
9.2 Fikja automatike.....	24	13.1 Informacioni i produktit dhe Fleta e informacionit të produktit*.....	34
9.3 Ventilatori i ftohjes.....	25	13.2 Kursimi i energjisë.....	35
10. UDHËZIME DHE KËSHILLA.....	25	14. STRUKTURA E MENYSË.....	36
10.1 Pjekje vent. me lagështirë.....	25	14.1 Menyja.....	36
10.2 Pjekje vent. me lagështirë - aksesorët e rekomanduar.....	25		

1. INFORMACIONI I SIGURISË

Përpara instalimit dhe përdorimit të pajisjes, lexoni me kujdes udhëzimet e ofruara. Prodhuesi nuk është përgjegjës për lëndimet apo dëmet si rezultat i instalimit apo përdorimit të papërshtatshëm. Gjithmonë mbajini udhëzimet në një vend të sigurt dhe ku mund të arrihen lehtë për t'iu referuar në të ardhmen.

1.1 Siguria e fëmijëve dhe personave me probleme

- Kjo pajisje mund të përdoret nga fëmijë të moshës 8 vjeç e sipër dhe persona me aftësi të kufizuara fizike, ndijimesh ose mendore ose që nuk kanë eksperiencë dhe njohuri, nëse këta mbahen nën mbikëqyrje ose udhëzohen për përdorimin e sigurt të pajisjes dhe i kuptojnë rreziqet e

përdorimit. Fëmijët nga nën 8 vjeç dhe personat me aftësi të kufizuara shumë të theksuara dhe komplekse duhet të mbahen larg nga pajisja, përveçse kur mbahen nën monitorim të vazhdueshëm.

- Fëmijët duhet të monitorohen për t'u siguruar se nuk luajnë me pajisjen.
- Mbajeni të gjithë paketimin larg nga fëmijët dhe hidheni atë siç kërkohet.
- **PARALAJMËRIM:** Mbajini fëmijët dhe kafshët shtëpiake larg pajisjes gjatë kohës që ajo është në punë ose që ftohet. Pjesët e arritshme nxehen gjatë përdorimit.
- Nëse pajisja ka një mekanizëm për sigurinë e fëmijëve, ai duhet aktivizuar.
- Fëmijët nuk duhet të kryejnë pastrimin dhe mirëmbajtjen e pajisjes pa mbikëqyrje.

1.2 Siguria e përgjithshme

- Vetëm një person i kualifikuar duhet ta instalojë këtë pajisje dhe të ndërrojë kabllon.
- Mos e përdorni pajisjen përpara se ta instaloni në strukturën inkaso.
- Përpara mirëmbajtjes, shkëputeni pajisjen nga rrjeti elektrik.
- Për të shmangur rreziqet elektrike, nëse kabloja elektrike është e dëmtuar, ajo duhet ndërruar nga prodhuesi, qendra e autorizuar e shërbimit ose persona me kualifikim të ngjashëm.
- **PARALAJMËRIM:** Për të shmangur mundësinë e goditjes elektrike, sigurohuni që pajisja të fiket përpara se të ndërroni llambën.
- **PARALAJMËRIM:** Pajisja dhe pjesët e saj të arritshme nxehen gjatë përdorimit. Duhet të keni kujdes që të shmangni prekjen e elementeve ngrohëse.
- Përdorni gjithmonë doreza furre për të hequr ose për të futur aksesoret ose enët për furrë.

- Për të hequr mbajtëset e rafteve, në fillim hiqni pjesën e përparme të mbajtëses së raftit dhe pastaj pjesën e pasme nga muret anësore. Montojini mbajtëset e rafteve në rendin e kundërt.
- Mos përdorni pastrues me avull për të pastruar pajisjen.
- Mos përdorni pastrues gërryes të fortë ose kruajtëse të mprehta metalike për të pastruar derën prej xhami, pasi mund të gërvishtet sipërfaqja, gjë e cila mund të shkaktojë krisjen e xhamit.
- Derdhjet e tepërta të ushqimeve duhen hequr përpara pastrimit pirolitik. Nxirrini të gjitha pjesët nga furra.

2. UDHËZIMET PËR SIGURINË

2.1 Instalimi



PARALAJMËRIM!

Vetëm një person i kualifikuar duhet ta instalojë këtë pajisje.

- Hiqni të gjithë paketimin.
- Mos instaloni ose mos përdorni një pajisje të dëmtuar.
- Ndiqni udhëzimet e instalimit të dhëna me pajisjen.
- Gjithmonë bëni kujdes kur e lëvizni pajisjen sepse është e rëndë. Përdorni gjithnjë doreza sigurie dhe këpucë të mbyllura.
- Mos e tërhiqni pajisjen nga doreza.
- Instalojeni pajisjen në një vend të sigurt dhe të përshtatshëm që plotëson kërkesat e instalimit.
- Ruani largësitë minimale nga pajisjet dhe njësitë e tjera.
- Përpara montimit të pajisjes, kontrolloni nëse dera e furrës hapet pa pengesë.
- Pajisja vjen me një sistem elektrik ftohjeje. Duhet vënë në punë përmes lidhjes nga priza.
- Njësia e integruar duhet të plotësojë kërkesat e stabilitetit të DIN 68930.

Lartësia minimale e mobilies (Mobilia nën lartësinë minimale të suprinës)	578 (600) mm
Gjerësia e mobilies	560 mm
Thellësia e mobilies	550 (550) mm
Lartësia e pjesës së përparme të pajisjes	594 mm
Lartësia e pjesës së pasme të pajisjes	576 mm

Gjerësia e pjesës së përparme të pajisjes	595 mm
Gjerësia e pjesës së pasme të pajisjes	559 mm
Thellësia e pajisjes	567 mm
Thellësia inkaso e pajisjes	546 mm
Gjerësia me derën të hapur	1027 mm
Madhësia minimale e hapjes së ventilimit. Hapja e vendosur në pjesën e pasme poshtë	560 x 20 mm
Gjatësia e kabllot kryesore të furnizimit. Kablloja është vendosur në këndin e djathtë të pjesës së pasme	1500 mm
Vidat e montimit	4 x 25 mm

2.2 Lidhja elektrike



PARALAJMËRIM!

Rrezik zjarri dhe goditjeje elektrike.

- Të gjitha lidhjet elektrike duhen kryer nga një elektrikist i kualifikuar.
- Pajisja duhet tokëzuar.
- Sigurohuni që parametrat në pllakën e specifikimeve të përkojnë me vlerat elektrike të rrjetit elektrik.
- Përdorni gjithmonë një prizë të tokëzuar të instaluar si duhet.
- Mos përdorni përshtatës me shumë spina dhe kabllot zgjatuese.
- Sigurohuni që të mos dëmtoni prizën dhe kabllon elektrike. Nëse kabllot elektrike duhet zëvendësuar, kjo duhet bërë nga Qendra jonë e autorizuar e shërbimit.
- Mos i lini kabllot elektrike që të prekin derën e pajisjes ose t'i afrohen asaj apo hapësirës poshtë pajisjes, veçanërisht kur është në punë ose dera është e nxehtë.
- Mbrojtja nga goditja e pjesëve me korrent dhe të izoluarat duhet të shtrëngohet në mënyrë të tillë që të mos hiqet pa vegla.
- Pajisjen futeni në prizë vetëm në fund të instalimit. Sigurohuni që spina të jetë e arritshme pas montimit të pajisjes.
- Nëse priza është e lirë, mos e futni spinën.
- Mos e shkëputni pajisjen nga rrjeti duke e tërhequr nga kabllot elektrike. Gjithmonë tërhiqeni kabllon elektrike duke e kapur nga spina.
- Përdorni mjetet e duhura izoluese: çelësat mbrojtës, siguresat (siguresat që vidhosen duhet të hiqen nga foleja), salvavitat dhe kontaktorët.
- Instalimi elektrik duhet të ketë një pajisje instaluese e cila ju lejon të shkëpusni pajisjen nga rrymat elektrike në të gjitha polet. Pajisja instaluese duhet të ketë një hapje kontakti me gjerësi minimale 3 mm.
- Mbylleni plotësisht derën e pajisjes, përpara se të lidhni spinën e rrymës me prizën e rrymës.

- Kjo pajisje ofrohet me spinë dhe kordon elektrik.

2.3 Përdorimi



PARALAJMËRIM!

Rrezik plagosjeje, djegiesh dhe goditjeje elektrike ose shpërthimi.

- Kjo pajisje është vetëm për përdorim shtëpiak (të brendshëm).
- Mos i ndryshoni specifikimet e pajisjes.
- Sigurohuni që vendet e ventilimit të mos jenë bllokuar.
- Mos harroni ta kontrolloni pajisjen gjatë punës.
- Çaktivizojeni pajisjen pas çdo përdorimi.
- Tregoni kujdes në hapjen e derës së pajisjes kur pajisja është në punë. Mund të çlirohet avulli i nxehtë.
- Mos e vendosni në punë pajisjen me duar të lagura ose kur keni pasur kontakt me ujin.
- Mos ushtroni presion mbi derën e hapur.
- Mos e përdorni pajisjen si sipërfaqe pune ose si sipërfaqe mbështetëse.
- Hapeni derën e pajisjes me kujdes. Përdorimi i përbërësve me alkool mund të krijojë një përzjerje alkooli dhe ajri.
- Mos lejoni që pajisja të bjerë në kontakt me shkëndija apo flakë të hapura kur hapni derën.
- Mos vendosni produkte që marrin flakë ose sende të lagura me produkte të ndezshme brenda, pranë pajisjes ose mbi të.



PARALAJMËRIM!

Rrezik dëmtimi i pajisjes.

- Për të parandaluar dëmtimin ose çngjyrosjen e emailit:
 - mos fusni enët e furrës ose objekte të tjera në pajisje drejtpërsëdrejti në fund.
 - mos fusni letër alumini drejtpërdrejt në pjesën e poshtme të hapësirës së pajisjes.
 - mos hidhni ujë drejtpërdrejt në pajisjen e nxehtë.
 - mos lini enë të lagura dhe ushqim në pajisje pasi të keni mbaruar gatimin.
 - bëni kujdes kur hiqni ose vendosni aksesorët.
- Çngjyrimi i emailimit ose i inoksit nuk ndikon në funksionimin e pajisjes.
- Përdorni tepsi të thellë për kekë të butë. Lëngjet e frutave shkaktojnë njolla që mund të mbesin përgjithmonë.
- Kjo pajisje përdoret vetëm për gatim. Ajo nuk duhet të përdoret për qëllime të tjera, për shembull për ngrohje dhome.
- Gatvani gjithmonë me derën e furrës të mbyllur.
- Nëse pajisja është instaluar pas një paneli mobilieje (p.sh. një derë), sigurohuni që dera të mos mbyllet asnjëherë kur pajisja është në punë. Pas një paneli të mbyllur mobilieje mund të akumulohet nxehtësi dhe lagështi, të cilat mund të shkaktojnë si rrjedhim dëme në pajisje, banesë apo dysheme. Mos e mbyllni panelin e mobilies derisa pajisja të jetë ftohur plotësisht pas përdorimit.

2.4 Kujdesi dhe pastrimi



PARALAJMËRIM!

Rrezik plagosjeje, zjarri ose dëmtimi të pajisjes.

- Përpara se të kryeni mirëmbajtjen e pajisjes, çaktivizojeni atë dhe hiqeni nga priza.
- Sigurohuni që pajisja të jetë e ftohtë. Ka rrezik që panelet prej xhami të thyhen.

- Ndërrojini menjëherë panelet prej xhami të derës kur janë të dëmtuara. Kontaktoni qendrën e autorizuar të shërbimit.
- Tregoni kujdes kur e hiqni derën nga pajisja. Dera është e rëndë!
- Pastrojeni pajisjen rregullisht për të parandaluar dëmtimin e materialit të sipërfaqes.
- Pastrojeni pajisjen me një leckë të butë të lagësht. Përdorni vetëm detergjente neutrale. Mos përdorni produkte gërryese, materiale pastruese të ashpra, tretës ose objekte metalike.
- Nëse përdorni spërkatës për furrën, ndiqni udhëzimet e sigurisë në paketim.

2.5 Pastrimi pirolitik



PARALAJMËRIM!

Rrezik plagosjeje/zjarri/emetimesh kimike (avuj) në regjimin pirolitik.

- Përpara se të kryeni funksionin Vetëpastrim pirolitik ose përpara përdorimit të parë ju lutemi hiqni nga hapësira e furrës:
 - çdo ushqim të mbetur, mbetje/rrjedhje vaji ose yndyre.
 - çdo objekt të lëvizshëm (përfshi raftet, shinat anësore etj., që kanë ardhur me produktin) veçanërisht çdo tenxhere, tigan, tavë, takëme etj., që nuk ngjisin.
- Lexoni me kujdes të gjitha udhëzimet për pastrim pirolitik.
- Mbajini fëmijët larg pajisjes, gjatë kohës që pastrimi pirolitik është në funksionim. Pajisja nxeht shumë dhe del ajër i nxehtë nga fletët e përparme të ajrimit.
- Pastrimi pirolitik është një operacion me temperaturë të lartë dhe mund të lëshojë tymra nga mbetjet e gatimit dhe materialet e ndërtimit, prandaj konsumatorët këshillohen të veprojnë si më poshtë:
 - të sigurojnë ajrosje të mirë gjatë dhe pas çdo pastrimi pirolitik.
 - të sigurojnë ajrosje të mirë gjatë përdorimit të parë dhe pas tij, në një temperaturë maksimale pune.
- Në ndryshim nga njerëzit, disa zogj dhe zvarranikë mund të jenë jashtëzakonisht të ndjeshëm ndaj avujve të fortë që dalin gjatë procesit të pastrimit në të gjitha furrat pirolitike.
 - Largoni çdo kafshë shtëpiake (veçanërisht zogjtë) nga zona pranë pajisjes gjatë dhe pas pastrimit pirolitik dhe në fillim përdorni funksionimin në temperaturë maksimale në një zonë të ajrosur mirë.
- Edhe kafshët e vogla shtëpiake mund të jenë të ndjeshme ndaj ndryshimeve të lokalizuara të temperaturave në afërsi të furrave pirolitike kur është në punë programi pirolitik i vetëpastrimit.
- Sipërfaqet jo ngjitëse në tenxhere, tiganë, tabaka, takëme etj., mund të dëmtohen nga përdorimi i funksionit të pastrimit pirolitik në temperaturë të lartë në të gjitha furrat pirolitike dhe mund të jenë gjithashtu burim për avuj të dëmshëm të nivelit të ulët.
- Avujt e lëshuar nga furrat pirolitike/mbetjet e gatimit siç përshkruhet nuk janë të dëmshme për njerëzit, duke përfshirë fëmijët ose personat me probleme mjekësore.

2.6 Ndryshimi i brendshëm



PARALAJMËRIM!

Rrezik goditjeje elektrike.

- Në lidhje me llambat brenda produktit dhe llambat e pjesëve të këmbimit të shitura veçmas: Këto llamba janë prodhuar për kushte ekstreme fizike në pajisjet elektroshtëpiake, si p.sh. temperaturë, dridhje, lagështirë, ose janë prodhuar për të sinjalizuar informacion rreth statusit të përdorimit të pajisjes. Ato nuk janë prodhuar për t'u përdorur në aplikacione të tjera dhe nuk janë të përshtatshme për ndriçim në ambiente shtëpiake.
- Përdorni vetëm llamba me të njëjtat specifike.

2.7 Shërbimi

- Për të riparuar pajisjen kontaktoni me qendrën të autorizuar të shërbimit.
- Përdorni vetëm pjesë këmbimi origjinale.

2.8 Eliminimi i pajisjes



PARALAJMËRIM!

Rrezik plagosjeje ose mbytjeje.

- Shkëputeni pajisjen nga rrjeti i furnizimit me energji.
- Priteni kabllon e rrjetit elektrik pranë pajisjes dhe hidheni atë.
- Hiqni kapësen e derës për të parandaluar ngecjen e fëmijëve dhe të kafshëve shtëpiake brenda pajisjes.

3. PËRSHKRIM I PRODUKTIT

3.1 Pasqyra e përgjithshme

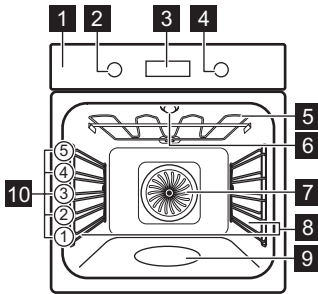

- 1** Paneli i kontrollit
- 2** Çelësi i funksioneve të ngrohjes
- 3** Ekрани
- 4** Çelësi i kontrollit
- 5** Elementi i ngrohjes
- 6** Llamba
- 7** Ventilimi
- 8** Mbështetje e raftit, i lëvizshëm
- 9** Poyicioni i raftit
- 10** Relievi i hapësirës së brendshme

SI TË NDEZIM DHE TË FIKIM FURRËN

3.2 Aksesorët

Rafti me rrjetë

Për enë gatimi, forma keku, rosto.

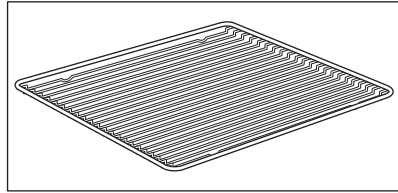

Tava e pjekjes

Për kekë dhe kuleçë.

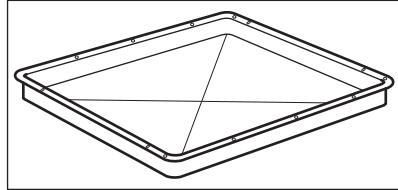

Tava e skarës/pjekjes

Për pjekje dhe rosto ose si tavë për mbledhjen e yndyrës.

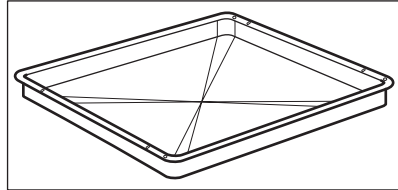

Korridori teleskopik

Për të futur dhe nxjerrë më lehtë tabakatë dhe raftin rrjetë.

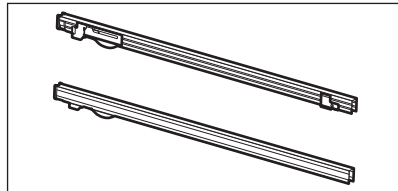









4. SI TË NDEZIM DHE TË FIKIM FURRËN







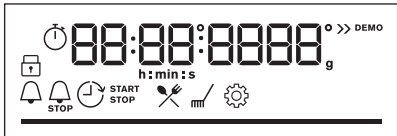

4.1 Dorezat e palosshme

Për të përdorur pajisjen shtypni çelësin. Çelësi del jashtë.

4.2 Paneli i kontrollit

Fushat e sensorit të panelit të kontrollit					Shtypni	Kthejeni çelësin
 Kohëmat ësi	 Nxehje e shpejtë	 Të lehta	 Lock	OK		
Zgjidhni një funksion ngrohjeje për të ndezur furrën.						
Kthejeni çelësin e funksioneve të nxehjes në pozicionin e fikjes për të fikur furrën.						

	Kur çelësi i funksioneve të ngrohjes është në pozicion të fikur, ekrani shkon në gatishmëri.
	Kur gatueri, ekrani tregon temperaturën e caktuar, orën e ditës dhe opsionet e tjera të disponueshme.
	Ekrani me numrin maksimal të funksioneve të vendosura.

Treguesit e ekranit				
 Kycje	 Gatim i asistuar	 Pastrimi	 Cilësimet	 Nxehje e shpejtë
Treguesit e kohëmatës it:				

Shiriti i progresit - për temperaturën ose kohën.	
--	---

PËRPARA PËRDORIMIT TË PARË

Treguesi i gatimit me avull



5. PËRPARA PËRDORIMIT TË PARË



PARALAJMËRIM!

Referojuni kapitujve për sigurinë.

5.1 Pastrimi fillestar

Para përdorimit të parë pastroni furrën bosh dhe vendosni kohën:



00:00

Vendosni kohën. Shtypni OK.

5.2 Ngrohja paraprake fillestare



Ngrohni paraprakisht furrën bosh përpara përdorimit të parë.

Hapi 1

Hiqni të gjithë aksesoret dhe mbajtëset e rafteve që mund të hiqen nga furra.

Hapi 2

Vendosni temperaturën maksimale për funksionin: .
Lëreni furrën të punojë për 1 orë.

Hapi 3

Vendosni temperaturën maksimale për funksionin: .
Lëreni furrën të punojë për 15 minuta.

Furra mund të nxjerrë erë të keqe dhe tym gjatë ngrohjes paraprake. Sigurohuni që dhoma të jetë e ajrosur mirë.



6. PËRDORIMI I PËRDITSHËM





PARALAJMËRIM!

Referojuni kapitujve për sigurinë.

6.1 Si ta programoni: Funksonet e nxehtjes









Nisja e gatimit	
Hapi 1	Hapi 2
	
Vendosni një funksion nxehtjeje.	Vendosni temperaturën.

Gatimi me avull			
Sigurohuni që furra të jetë e ftohtë.			
Hapi 1	Hapi 2	Hapi 3	Hapi 4
			<p>Nxehtni paraprakisht furrën bosh për 10 minuta për të krijuar lagështirë. Futni ushqim në furrë.</p>
Mbusheni relievin e hapësirës së brendshme me ujë rubineti.	Vendosni funksionin e nxehtjes me avull.	Vendosni temperaturën.	
<p>i Kapaciteti maksimal i relievit të hapësirës së brendshme është 250 ml. Mos e rimbushni relievin e hapësirës së brendshme gjatë gatimit ose kur furra është e nxehtë.</p>			

Kur mbaron gatimi me avull:		
Hapi 1	Hapi 2	Hapi 3
Kthejeni çelësin e funksioneve të nxehtjes në pozicionin e fikjes për të fikur furrën.	Hapni derën plotësisht. Lagështira e çliruar mund të shkaktojë djegie.	Sigurohuni që furra të jetë e ftohtë. Hiqni ujin e mbetur nga relievi i hapësirës së brendshme.

6.2 Funksonet e nxehtjes

Funksionet standarde të ngrohjes

Funksioni e ngrohjes	Përdorimi
 <p>Ventilator i plotë</p>	Për të pjekur në deri në tre pozicione të raftit njëkohësisht dhe për të tharë ushqimin. Vendoseni temperaturën 20 - 40°C më të ulët se për Gatim tradicional.
 <p>Gatim tradicional</p>	Për të pjekur ushqimin në një nivel furre.
 <p>SteamBake</p>	Për të shtuar lagështirë gjatë gatimit. Për të marrë ngjyrën e duhur dhe kore kërcitëse gjatë pjekjes. Për të dhënë më shumë lëng gjatë ringrohjes. Për konservimin e frutave ose zarzavateve.
 <p>Funksioni i picës</p>	Për të pjekur pica. Për karamelizim intensiv dhe një fund kërcitës.
 <p>Nxehtësia e poshtme</p>	Për pjekjen e kekëve me fund kërcitës dhe për ruajtjen e ushqimit.
 <p>Ushqime të ngrira</p>	Për të gatuar ushqime të shpejta (p.sh. patate të skuqura, patate me prerje trekëndore ose kuleç) krokante.
 <p>Pjekje vent. me lagështirë</p>	Ky funksion është projektuar për të kursyer energjinë gjatë gatimit. Kur përdorni këtë funksion, temperatura në hapësirën e brendshme mund të ndryshojë nga temperatura e vendosur. Përdoret nxehtësia e mbetur. Fuqia e ngrohjes mund të jetë e ulët. Për më shumë informacion, referojuni kapitullit "Përdorimi i përditshëm", "Shënime mbi": Pjekje vent. me lagështirë.
 <p>Skara</p>	Për të pjekur në skarë ushqime të sheshta dhe për të thekur bukë.
 <p>Skarë turbo</p>	Për të pjekur nyja të mëdha mishi ose shpendësh me kocka në një pozicion rafti. Për të bërë gratina dhe për të karamelizuar.

Funksioni e ngrohjes	Përdorimi
 Menyja	Për të hyrë në menu: Gatim i asistuar, Pastrimi, Cilësimet.

6.3 Shënime mbi: Pjekje vent. me lagështirë

Ky funksion është përdorur për të qenë në pajtim me klasin e efikasitetit energjetik dhe kërkesat e ekodizajnit sipas BE 65/2014 dhe BE 66/2014. Testet sipas EN 60350-1.

Dera e furrës duhet të mbyllet gjatë gatimit në mënyrë që funksioni të mos ndërpritet dhe që furra të funksionojë me efikasitetin më të lartë të mundshëm të energjisë.

Kur përdorni këtë funksion llamba fiket automatikisht pas 30 sekondash.

Për udhëzimet e gatimit shihni kapitullin "Udhëzime dhe këshilla", Pjekje vent. me lagështirë.



Për rekomandimet e përgjithshme të kursimit të energjisë, shihni kapitullin "Efikasiteti energjetik", Kursimi i energjisë.

6.4 Si ta programoni: Gatim i asistuar

Çdo gatim në këtë nënmeny ka një funksion dhe temperaturë të rekomanduar. Mund ta rregulloni kohën dhe temperaturën gjatë gatimit.

Gatim i asistuar - përdoreni për të përgatitur një pjatë shpejt me cilësimet e paracaktuara:			
Hapi 1	Hapi 2	Hapi 3	Hapi 4
 	 	 1 - 45	 OK
Hyni në meny.	Zgjidhni Gatim i asistuar. Shtypni OK .	Zgjidhni gatimin. Shtypni OK .	Vendoseni enën në furrë. Konfirmohet cilësimin.







6.5 Gatim i asistuar me receta

Legjenda	
	Sasia e ujit për funksionin e avullit.
	Ngrohni furrën bosh përpara gatimit.
	Niveli i raftit.











Kur funksioni mbaron kontrolloni nëse ushqimi është gati.



















PËRDORIMI I PËRDITSHËM

	Gatimi	Pesha	Niveli i raftit / Aksessori	Kohëzgjatja
Mish lope 🐄				
P1	Mish i pjekur lope, i pjekur pak	1 - 1,5 kg; pjesë të trasha 4 - 5 cm	☑️ 2; tepsi pjekjeje Skuqni mishin për disa minuta në një tigan të nxehtë. Futeni në furrë.	40 min
P2	Mish i pjekur lope, mesatare			50 min
P3	Mish i pjekur lope, e pjekur mirë			60 min
P4	Biftek, mesatare	180 - 220 g për copë; feta 3 cm trashësi	☑️ ☑️ 3; enë pjekjeje në raftin e telit Skuqni mishin për disa minuta në një tigan të nxehtë. Futeni në furrë.	15 min
P5	Rosto viçi / fërguar (brinjë kryesore, rrethore lart, anësore e trashë)	1,5 - 2 kg	☑️ 2; enë pjekjeje në raftin e telit Skuqni mishin për disa minuta në një tigan të nxehtë. Shtoni lëng. Futeni në furrë.	120 min
P6	Mish i pjekur lope, i pjekur pak (gatim i ngadaltë)	1 - 1,5 kg; pjesë të trasha 4 - 5 cm	☑️ 2; tepsi pjekjeje Përdorni erëzat tuaja të preferuara ose thjesht kripë dhe piper të freskët të bluar. Skuqni mishin për disa minuta në një tigan të nxehtë. Futeni në furrë.	75 min
P7	Mish i pjekur lope, mesatare (gatim i ngadaltë)			85 min
P8	Mish i pjekur lope, e pjekur mirë (gatim i ngadaltë)			130 min











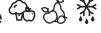



	Gatimi	Pesha	Niveli i raftit / Aksesori	Kohëzgjatja
P9	Filetë, e pjekur pak (gatim i ngadaltë)			75 min
P10	Filetë, mesatare (gatim i ngadaltë)	0,5 - 1,5 kg; pjesë të trasha 5 - 6 cm	 2; tepsi pjekjeje Përdorni erëzat tuaja të preferuara ose thjesht kripë dhe piper të freskët të bluar. Skuqni mishin për disa minuta në një tigan të nxehtë. Futeni në furrë.	90 min
P11	Fileto, e pjekur mirë (gatim i ngadaltë)			120 min
Mish viçi 				
P12	Rosto viçi (p.sh. shpatull)	0,8 - 1,5 kg; pjesë të trasha 4 cm	 2; enë pjekjeje në raftin e telit Përdorni erëzat tuaja të preferuara. Shtoni lëng. Pjekje e mbuluar.	80 min
Mish derri 				
P13	Qafa ose shpatulla e pjekur nga derri	1,5 - 2 kg	 2; enë pjekjeje në raftin e telit Pasi të ketë kaluar gjysma e kohës së gatimit, kthejeni mishin nga ana tjetër.	120 min
P14	Derr i tërhequr g.t.u	1,5 - 2 kg	 2; tepsi pjekjeje Përdorni erëzat tuaja të preferuara. Pasi të ketë kaluar gjysma e kohës së gatimit, kthejeni mishin nga ana tjetër për pjekje të barabartë.	215 min
P15	ljë, e freskët	1 - 1,5 kg; pjesë të trasha 5 - 6 cm	 2; enë pjekjeje në raftin e telit Përdorni erëzat tuaja të preferuara.	55 min





PËRDORIMI I PËRDITSHËM

	Gatimi	Pesha	Niveli i raftit / Aksesori	Kohëzgjatja
P16	Brinjë	2 - 3 kg; përdorni brinjë të pagatuara, 2 - 3 cm të hollë	 3; tigan i thellë Shtoni lëng për të mbuluar pjesën e poshtme të enës. Pasi të ketë kaluar gjysma e kohës së gatimit, kthejeni mishin nga ana tjetër.	90 min
Mish qengji 				
P17	Kofshë qengji me kocka	1,5 - 2 kg; pjesë të trashë 7 - 9 cm	 2; gatim rasto në tepsi pjekjeje Shtoni lëng. Pasi të ketë kaluar gjysma e kohës së gatimit, kthejeni mishin nga ana tjetër.	130 min
Shpezë 				
P18	Pulë e plotë	1 - 1,5 kg; të freskëta	 2;  200 ml; gatim tave në tepsi pjekjeje Përdorni erëzat tuaja të preferuara. Pasi të ketë kaluar gjysma e kohës së gatimit, kthejeni pulën nga ana tjetër për pjekje të barabartë.	60 min
P19	Gjysmë pule	0,5 - 0,8 kg	 3 ; tepsi pjekjeje Përdorni erëzat tuaja të preferuara.	40 min
P20	Gjoks pule	180 - 200 g për copë	  2; tavë në raftin e telit Përdorni erëzat tuaja të preferuara. Skuqni mishin për disa minuta në një tigan të nxehtë.	25 min
P21	Kofshë pule, të freskëta	-	 3; tepsi pjekjeje Nëse së pari keni marinuar këmbët e pulës, vendosni temperaturë më të ulët dhe gatuajini më gjatë.	30 min
P22	Rosë, e plotë	2 - 3 kg	 2; enë pjekjeje në raftin e telit Përdorni erëzat tuaja të preferuara. Vendoseni mishin në tavën e rostos. Pasi të ketë kaluar gjysma e kohës së gatimit, kthejeni rosën nga ana tjetër.	100 min

	Gatimi	Pesha	Niveli i raftit / Aksesori	Kohëzgjatja
P23	Patë, e plotë	4 - 5 kg	 2; tigan i thellë Përdorni erëzat tuaja të preferuara. Vendoseni mishin në tepsinë e thellë të pjekjes. Pasi të ketë kaluar gjysma e kohës së gatimit, kthejeni patën nga ana tjetër.	110 min
Tjetër 				
P24	Copë mishi	1 kg	 2; raft me tel Përdorni erëzat tuaja të preferuara.	60 min
Peshk 				
P25	Peshk i plotë, në skarë	0,5 - 1 kg për peshk	 2 ; tepsi pjekjeje Mbusheni peshkun me gjalpë dhe përdorni erëzat dhe barishtet tuaja të preferuara.	30 min
P26	Fileta peshku	-	  3; tavë në raftin e telit Përdorni erëzat tuaja të preferuara.	20 min
Pjekje të ëmbla/ëmbëlsira 				
P27	Kek me qumështor	-	 2;  28 cm formë në skarën me tel	90 min
P28	Kek me mollë	-	 2;  100 - 150 ml; tepsi pjekjeje	60 min
P29	Tartë me mollë	-	 2; formë byreku në skarën me tel	40 min
P30	Ëmbëlsirë me mollë	-	 2;  100 - 150 ml;  22 cm formë byreku në skarën me tel	60 min
P31	Kekë Brownie	2 kg	 3; tigan i thellë	30 min
P32	Kekë në kupa me çokollatë	-	 2;  100 - 150 ml; tepsi kekësh me kupa në raftin e telit	30 min





PËRDORIMI I PËRDITSHËM

	Gatimi	Pesha	Niveli i raftit / Aksesorë	Kohëzgjatja
P33	Kek klasik	-	 2; tepsi keku në skarën me tel	50 min
Gatime me perime/shoqëruese 				
P34	Patate të pjekura	1 kg	 2; tepsi pjekjeje Vendosini patatet e plota me lëkurë në tepsinë e pjekjes.	50 min
P35	Feta	1 kg	 3; tepsi pjekjeje e veshur me letër furre Përdorni erëzat tuaja të preferuara. Pritini patatet në copa.	35 min
P36	Perime të përziera në skarë	1 - 1,5 kg	 3; tepsi pjekjeje e veshur me letër furre Përdorni erëzat tuaja të preferuara. Pritini perimet në copa.	30 min
P37	Kroketa, të ngrira	0,5 kg	 3; tepsi pjekjeje	25 min
P38	Patate të holla, të ngrira	0,75 kg	 3; tepsi pjekjeje	25 min
Gratina, bukë dhe picë 				
P39	Lazanja/tavë me makarona kineze	1 - 1,5 kg	 2; tavë në raftin e telit	45 min
P40	Patate gratin	1 - 1,5 kg	 1; tavë në raftin e telit	50 min
P41	Picë e freskët, e hollë	-	 2;  100 ml; tepsi pjekjeje e veshur me letër furre	15 min
P42	Picë e freskët, e trashë	-	 2;  100 ml; tepsi pjekjeje e veshur me letër furre	25 min
P43	Quiche	-	 2; formë pjekjeje në skarën me tel	45 min



	Gatimi	Pesha	Niveli i raftit / Aksesori	Kohëzgjatja
P44	Bagetë / çabatë / bukë e bardhë	0,8 kg	 3;  150 ml; tepsi pjekjeje e veshur me letër furre Duhet më shumë kohë për bukë të bardhë.	30 min
P45	Të gjitha drithërat / thekra / buka e errët të gjitha drithërat në tepsinë e bukës	1 kg	 2;  150 ml; tepsi pjekjeje e veshur me letër furre / taft teli	45 min

7. FUNKSIONET E ORËS

7.1 Funksionet e orës

Funksioni i orës	Përdorimi
	Kujtuesi i minutave. Kur përfundon koha, bie sinjali akustik.
	Koha e gatimit. Kur përfundon kohëmatësi, bie sinjali dhe ndalon funksioni i nxehjes.
	Shtyrja e orarit. Për të shtyrë fillimin dhe/ose përfundimin e gatimit.
	Kohëmatësi me rritje. Maksimumi është 23 orë 59 minuta. Ky funksion nuk ndikon në funksionimin e furrës. Për të ndezur dhe fikur Kohëmatësi me rritje, zgjidhni: Menyja, Cilësimet.

7.2 Si ta programoni: Funksionet e orës





Mënyra e vendosjes: Ora Ditore		
Hapi 1	Hapi 2	Hapi 3
		

FUNKSIONET E ORËS

Mënyra e vendosjes: Ora Ditore







Për të ndryshuar orën e ditës, hyni te menuja dhe zgjidhni Cilësimet, periudha e ditës.	Caktoni orën.	Shtypni: OK.
---	---------------	--------------

Mënyra e vendosjes: Kujtuesi i minutave

Hapi 1	Ekрани tregon: 0:00 	Hapi 2	Hapi 3
			
Shtypni: 		Caktoni Kujtuesi i minutave	Shtypni: OK.

 Kohëmatësi fillon menjëherë numërimin mbrapsht.









Mënyra e vendosjes: Koha e gatimit

Hapi 1	Hapi 2	Ekрани tregon: 0:00  STOP	Hapi 3	Hapi 4
				
Zgjidhni një funksion nxehjeje dhe vendosni temperaturën.	Shtypeni disa herë: 		Vendosni kohën e gatimit.	Shtypni: OK.

 Kohëmatësi fillon menjëherë numërimin mbrapsht.

MËNYRA E PËRDORIMIT: AKSESORËT

Mënyra e vendosjes: Shtyrja e orarit

Hapi 1	Hapi 2		Hapi 3	Hapi 4		Hapi 5	Hapi 6
		Në ekran shfaqet: periudha e ditës  NISJA			Ekran i tregon: ---  NDALIM I		
Zgjidhni funksionin e nevojshes.	Shtypeni disa herë: 		Vendosni kohën e fillimit.	Shtypni: OK.		Vendosni kohën e mbarimit.	Shtypni: OK.

 Kohëmatësi fillon të numërojë mbrapsht në një kohë të caktuar fillimi.

8. MËNYRA E PËRDORIMIT: AKSESORËT

8.1 Futja e aksesorëve

Një dhëmbëzim i vogël në pjesën e sipërme rrit sigurinë. Dhëmbëzimet janë gjithashtu mjete që parandalojnë përmbysjen. Buzët e ngritura përreth skarës parandalojnë rrëshqitjen nga rafti.

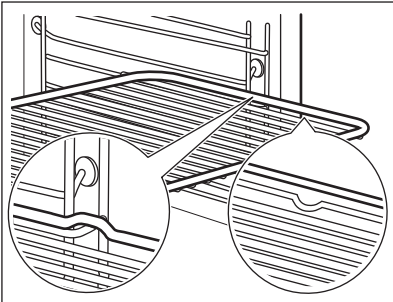
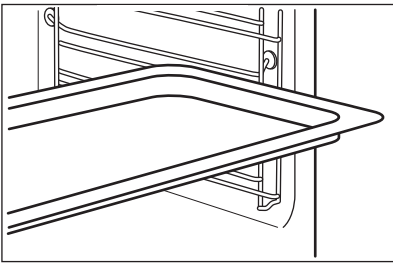
<p>Rafti me rrjetë: Shtyni raftin mes shufrave udhëzuese të mbajtëses së raftit.</p>	
<p>Tava e pjekjes /Tigan i thellë: Shtyni tavën midis shufrave drejtuese të mbajtëses së raftit.</p>	

FUNKSIONET SHITESË

Rafti me rrjetë, Tava e pjekjes /Tigan i thellë:

Shtyni tavën ndërmjet shufrave udhëzuese të mbajtëses së raftit dhe raftin me rrjetë në shufrat udhëzuese më sipër.

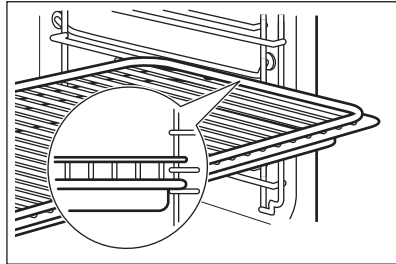

9. FUNKSIONET SHITESË

9.1 Kyçje



Ky funksion parandalon ndryshimin pa dashje të funksionit të furrës.

Ndizeni kur furra punon - gatimi i vendosur vazhdon, paneli i kontrollit është i kyçur.
Ndizeni kur furra është e fikur - furra nuk mund të ndizet, paneli i kontrollit është i kyçur.





 - shtypeni e mbajeni për të aktivizuar funksionin.
Tingëllon një sinjal.

 - shtypeni e mbajeni për të ta çaktivizuar.

 3 x  - pulson kur aktivizohet kyçja.

9.2 Fikja automatike

Për arsye sigurie furra fiket pas një farë kohe nëse një funksion i ngrohjes është në veprim dhe ju nuk ndryshoni asnjë cilësim.

 (°C)	 (h)
30 - 115	12.5
120 - 195	8.5
200 - 245	5.5
250 - maksimumi	3

Fikja automatike nuk punon me funksionet: Të lehta, Shtyrja e orarit.



9.3 Ventilatori i ftohjes

Kur furra është në punë, ventilatori ftohës ndizet aktivizohet për t'i mbajtur sipërfaqet e furrës të ftohta. Nëse fikni furrën, ventilatori ftohës mund të vazhdojë të punojë derisa të ftohet furra.

10. UDHËZIME DHE KËSHILLA

10.1 Pjekje vent. me lagështirë

Për rezultate optimale ndiqni sugjerimet e listuara në tabelën më poshtë. Përdorni pozicionin e tretë të furrës.

	 (°C)	 (min)
Makarona të gratinuara	200 - 220	45 - 55
Patate gratin	180 - 200	70 - 85
Musaka	170 - 190	70 - 95
Lazanja	180 - 200	75 - 90
Kaneloni	180 - 200	70 - 85
Puding me bukë	190 - 200	55 - 70
Puding me oriz	170 - 190	45 - 60
Kek me mollë, me brumë me pandispanjë (forma e rrumbullakët e kekut)	160 - 170	70 - 80
Bukë e bardhë	190 - 200	55 - 70

10.2 Pjekje vent. me lagështirë - aksesoret e rekomanduara

Përdorni tava dhe enë të errëta dhe joreflektuese. Ato e thithin më mirë nxehtësinë se enët me ngjyrë të çelur dhe reflektuese.







 Tavë pice	 Tavë gatimi	 Tasa qeramike	 Tavë për bazë pandispanje
---	--	--	---







E errët, joreflektuese 28 cm diametër	E errët, joreflektuese 26 cm diametër	Qeramikë 8 cm diametër, 5 cm lartësi	E errët, joreflektuese 28 cm diametër
--	--	--	--

10.3 Tabelat e gatimit për institutet e testimit

Informacion për institutet e testimit

Testimet sipas: EN 60350, IEC 60350.

 PJEKJA NË NJË NIVEL. Pjekja në forma				
		 (°C)	 (min)	
Pandispanjë pa yndyrë	Ventilator i plotë	140 - 150	35 - 50	2
Pandispanjë pa yndyrë	Gatim tradicional	160	35 - 50	2
Ëmbëlsirë me mollë, 2 tava Ø20 cm	Ventilator i plotë	160	60 - 90	2
Ëmbëlsirë me mollë, 2 tava Ø20 cm	Gatim tradicional	180	70 - 90	1





 PJEKJA NË NJË NIVEL. Biskota				
 Përdorni nivelin e tretë të furrës.				
		 (°C)	 (min)	
Amareta / Ripa paste	Ventilator i plotë	140	25 - 40	
Amareta / Ripa paste, ngrohni paraprakisht furrën bosh	Gatim tradicional	160	20 - 30	



PJEKJA NË NJË NIVEL. Biskota







Përdorni nivelin e tretë të furrës.

		 (°C)	 (min)
Kekë të vegjël, 20 për tepsi, ngrohni paraprakisht furrën bosh	Ventilator i plotë	150	20 - 35
Kekë të vegjël, 20 për tepsi, ngrohni paraprakisht furrën bosh	Gatim tradicional	170	20 - 30



PJEKJE NË SHUMË NIVELE. Biskota

		 (°C)	 (min)	
Amareta / Ripa paste	Ventilator i plotë	140	25 - 45	1 / 4
Kekë të vegjël, 20 për tepsi, ngrohni paraprakisht furrën bosh	Ventilator i plotë	150	23 - 40	1 / 4
Pandispanjë pa yndyrë	Ventilator i plotë	160	35 - 50	1 / 4

KUJDESI DHE PASTRIMI



SKARA



Ngroheni furrën paraprakisht bosh për 5 minuta.



Piqni në skarë me temperaturë maksimale.



(min)



Bukë e thekur

Skara

1 - 3

5

Biftek viçi, kthejeni pasi të ketë kaluar gjysma e kohës

Skara

24 - 30

4

11. KUJDESI DHE PASTRIMI



PARALAJMËRIM!

Referojuni kapitujve për sigurinë.

11.1 Shënime mbi pastrimin



Agjentët e pastrimit

Pastroni pjesën e përparme të furrës me një copë të butë me ujë të ngrohtë dhe një detergjent të butë.

Përdorni një solucion pastrues për të pastruar sipërfaqet metalike.

Pastroni njollat me një detergjent të butë.



Përdorimi i përditshëm

Pastrojeni hapësirën e brendshme pas çdo përdorimi. Grumbullimi i yndyrës ose mbetjeve të tjera mund të shkaktojë zjarr.

Mos e ruani ushqimin në furrë për më shumë se 20 minuta. Thajeni brendësinë me një leckë të butë pas çdo përdorimi.

 <p>Aksesorët</p>	<p>Pastrojini të gjithë aksesorët pas çdo përdorimi dhe lërii të thahen. Përdorni një leckë të butë me ujë të ngrohtë dhe detergjent të butë. Mos i pastroni aksesorët në lavastovilje.</p>
	<p>Mos i pastroni aksesorët që nuk ngjisin duke përdorur pastrues agresivë ose objekte me majë të mprehtë.</p>

11.2 Si ta pastroni: Zbalcim i brendshëm

Pastroni relievin e hapësirës së brendshme për të hequr mbetjet e çmërsit pas gatimit me avull.

Hapi 1	Hapi 2	Hapi 3
<p>Hidhni: 250 ml uthull në relievin e hapësirës së brendshme. Përdorni maksimumi 6% uthull pa aditivë.</p>	<p>Lërii uthullën të tresë mbetjet e çmërsit në temperaturë ambiente për 30 minuta.</p>	<p>Fshijeni pjesën e brendshme me një leckë të butë.</p>
<p>Për funksionin: SteamBake pastroni furrën për çdo 5 - 10 cikle gatimi.</p>		

11.3 Mënyra e heqjes: Mbajtëset e rafteve

Hiqni mbajtëset e rafteve për të pastruar furrën.

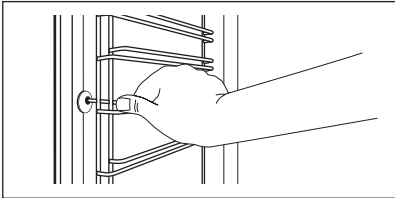
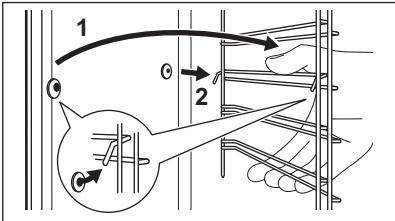
Hapi 1	Fikni furrën dhe prisni derisa të ftohet.	
Hapi 2	Tërhiqni pjesën ballore të mbajtëses nga paret anësor.	
Hapi 3	Tërhiqni pjesën e pasme të mbajtëses së rafteve jashtë paretit anësor dhe hiqni.	
Hapi 4	Montojini mbajtëset e rafteve në rendin e kundërt. Kunjat te shinat teleskopike nuk duhet të jenë vendosur përpara.	

11.4 Si ta përdorni: Pastrimi pirolitik

Pastrojeni furrën me Pastrimi pirolitik.

KUJDESI DHE PASTRIMI



PARALAJMËRIM!

Ekziston mundësia e djegies.





KUJDESI!

Nëse ka pajisje të tjera të instaluara në të njëjtën ndarje, mos i përdorni njëkohësisht me këtë funksion. Kjo mund t'i shkaktojë dëmtim furrës.

Përpara Pastrimi pirolitik:

Fikni furrën dhe prisni derisa të ftohet.	Hiqni të gjithë aksesorët dhe mbështetëset e raftëve që mund të hiqen.	Pastroni dyshtemenë e furrës dhe xhamin e brendshëm të derës me ujë të ngrohtë, leckë të butë dhe detergjent të butë.
---	--	---

Pastrimi pirolitik

Hapi 1	Hyni në menu: Pastrimi  .
Opsioni	Kohëzgjatja
C1 - Pastrimi i lehtë	1 h
C2 - Pastrim normal	1 h 30 min
C3 - Pastrim i plotë	3 h
Hapi 2	OK - shtypni për të zgjedhur programin e pastrimit.
Hapi 3	OK - shtypeni për të filluar pastrimin.
Hapi 4	Pas pastrimit, rrotullojeni çelësin e funksioneve të nxehjes në pozicionin e çaktivizimit.
 Gjatë pastrimit, llamba e furrës qëndron e fikur.	
Kur furra arrin temperaturën e caktuar, dera kyçet. Derisa të shkyçet dera ekrani tregon:  .	

Kur përfundon pastrimi:

Fikni furrën dhe prisni derisa të ftohet.	Fshijeni pjesën e brendshme me një leckë të butë.	Hiqni mbetjet nga fundi i pjesës së brendshme.
---	---	--

11.5 Kujtuesi i pastrimit

Furra ju kujton se kur duhet ta pastroni me pastrim pirolitik.

 pulson në ekran për 5 sekonda pas çdo seance gatimi.

Për të fikur kujtuesin, hyni te Menyja dhe zgjidhni Cilësimet, Kujtuesi i pastrimit.

11.6 Mënyra e heqjes dhe e instalimit: Dera

Mund të hiqni derën dhe panelet e brendshme të xhamit për t'i pastruar. Numri i paneleve të xhamit ndryshon sipas modelit.



PARALAJMËRIM!

Dera është e rëndë.



KUJDESI!

Trajtojeni me kujdes xhamin, veçanërisht rreth anëve të panelit të përparmë. Xhami mund të thyhet.

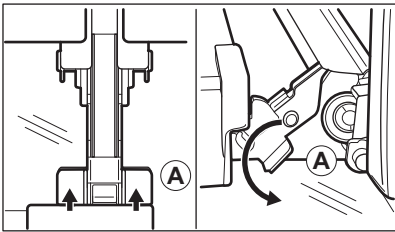
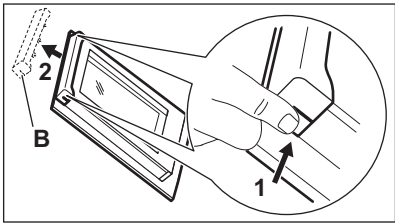
Hapi 1	Hapni derën plotësisht.	
Hapi 2	Ngrini dhe shtyni levat fiksuese (A) në dy menteshat e derës.	
Hapi 3	Mbyllni derën e furrës në pozicionin e parë të hapjes (në kënd rreth 70°). Mbajeni derën në të dyja anët dhe tërhiqeni me kënd lart për ta nxjerrë nga furra. Shtriheni derën nga pjesë a jashtme në një pëlhurë të butë mbi një sipërfaqe të qëndrueshme.	
Hapi 4	Mbani shtrënguar në të dy anët kornizën (B) e sipërme të derës dhe shtyni nga brenda për ta çliruar nga kllapa.	
Hapi 5	Tërhiqeni kornizën e derës drejt vetes për ta hequr.	
Hapi 6	Mbani panelet prej xhami të derës nga cepat e sipërm njëri pas tjetrit dhe tërhiqini nga sipër për t'i nxjerrë nga vendi.	

ZGJIDHJA E PROBLEMEVE

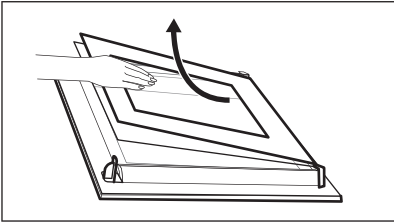
Hapi 7	Pastroni panelin e xhamit me ujë dhe sapun. Fshini me kujdes panelin prej xhami. Mos i pastroni panelet e xhamit në lavastovilje.	
Hapi 8	Pas pastrimit, kryeni hapat e mësipërm në rendin e kundërt.	
Hapi 9	Në fillim vendosni panelin më të vogël të ndjekur nga ai më i madhi dhe më pas derën. Sigurohuni që xhamat të futen në pozicionin e duhur, ndryshe sipërfaqja e derës mund të mbinxehet.	

11.7 Mënyra e ndërrimit: Llamba



PARALAJMËRIM!

Rrezik goditjeje elektrike.
Llamba mund të jetë e nxehtë.

Përpara se të zëvendësoni llambën e furrës:		
Hapi 1	Hapi 2	Hapi 3
Fikni furrën. Prisni derisa furra të jetë ftohur.	Shkëputeni furrën nga priza e korrentit.	Vendosni një pëlhurë në fund të zgavrës.

Llamba e sipërme

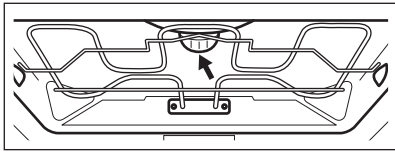
Hapi 1	Rrotullojeni kapakun e llambës për ta hequr.	
Hapi 2	Pastroni mbulesën prej xhami.	
Hapi 3	Ndërroni llambën me një llambë të përshtatshme që i reziston nxehtësisë 300 °C.	
Hapi 4	Montoni kapakun prej xhami.	

12. ZGJIDHJA E PROBLEMEVE



PARALAJMËRIM!

Referojuni kapitujve për sigurinë.

12.1 Çfarë duhet bërë nëse...

Në çdo rast që nuk përfshihet në këtë tabelë, ju lutemi kontaktoni me një qendër të autorizuar shërbimi.



Furra nuk ndizet ose nuk nxehet

Problemi	Kontrolloni nëse...
Nuk arrini ta aktivizoni ose ta vini në punë furrën.	Furra është e lidhur saktë me rrjetin elektrik.
Furra nuk nxehet.	Fikja automatike është e çaktivizuar.
Furra nuk nxehet.	Dera e furrës është e mbyllur.
Furra nuk nxehet.	Është djegur siguresa.
Furra nuk nxehet.	Bllokimi për fëmijët është i çaktivizuar.



Komponentët

Problemi	Kontrolloni nëse...
Llamba është e fikur.	Pjekje vent. me lagështirë - është e ndezur.
Llamba nuk punon.	Llamba është djegur.



Kodet e defekteve

Ekрани shfaq...	Kontrolloni nëse...
Err C3	Dera e furrës është e mbyllur ose kyçi i derës nuk është i prishur.
Err F102	Dera e furrës është e mbyllur.

EFIKASITETI ENERGJETIK



Kodet e defekteve

Err F102	Kyçi i derës nuk është i prishur.
00:00	Pati një ndërprerje të energjisë. Caktimi i periudhës së ditës.
Nëse ekrani shfaq një kod defekti i cili nuk është në këtë tabelë, fikni dhe ndizni siguresën e shtëpisë për të rinisur furrën. Nëse kodi i defektit shfaqet, kontaktoni me qendrën e autorizuar të shërbimit.	



Pastrimi

Problemi	Kontrolloni nëse...
Rrjedh ujë nga relievi i hapësirës së brendshme.	Ka shumë ujë në relievin e hapësirës së brendshme.

12.2 Të dhëna për shërbimin

Nëse nuk e gjeni dot vetë një zgjidhje, kontaktoni shitësin tuaj ose me një qendër shërbimi të autorizuar.

Të dhënat e nevojshme për qendrën e shërbimit ndodhen në etiketën e parametrave. Etiketa e specifikimeve gjendet në kornizën ballore të hapësirës së furrës. Mos e hiqni pllakën e specifikimeve nga pjesa e brendshme e furrës.

Rekomandojmë që ju t'i shkruani të dhënat këtu:

Modeli (MOD.)
Numri i produktit (PNC)
Numri serial (S.N.)

13. EFIKASITETI ENERGJETIK

13.1 Informacioni i produktit dhe Fleta e informacionit të produktit*

Emri i furnitorit	AEG
-------------------	-----

Identifikimi i modelit	BPB351160M 944188506 BPS351160M 944188507	
Indeksi i efikasitetit energjetik	81.2	
Klasi i efikasitetit të energjisë	A+	
Konsumi i energjisë me ngarkesë standarde, regjimi tradicional	1.09 kWh/cikël	
Konsumi i energjisë me ngarkesë standarde, regjimi me ventilim	0.69 kWh/cikël	
Numri i zgavrave	1	
Burimi i nxehtësisë	Elektriciteti	
Volumit	71 l	
Lloji i furrës	Furrë inkaso	
Masa	BPB351160M	34.0 kg
	BPS351160M	34.0 kg

* Për Bashkimin Evropian sipas Rregulloreve të BE-së 65/2014 dhe 66/2014.
Për Republikën e Bjellorusisë sipas STB 2478-2017, Shtojca G; STB 2477-2017, Aneksat A dhe B.
Për Ukrainën sipas 568/32020.

Kategoria e efikasitetit të energjisë nuk aplikohet për Rusinë.

EN 60350-1 - Pajisje shtëpiake gatimi me energji elektrike - Pjesa 1: Diapazonet, furrat, furrat me avull dhe skarat - Mënyrat e vlerësimit të performancës.

13.2 Kursimi i energjisë



Furra ka disa karakteristika që ju ndihmojnë të kurseni energji gjatë gatimit të përditshëm.

Sigurohuni që dera e furrës të jetë e mbyllur kur furra është në punë. Mos e hapni derën e furrës shumë shpesh gjatë gatimit. Mbajeni guarnicionin e derës të pastër dhe sigurohuni që të jetë i fiksuar mirë në vend.

Përdorni enë metalike për të përmirësuar kursimin e energjisë.

Kur është e mundur, mos e ngrohni furrën përpara se të gatuar.

Mbajini periudhat e pushimit mes gatimeve sa më të shkurtra që të jetë e mundur kur përgatitni pak gatime njëkohësisht.

STRUKTURA E MENYSË

Gatimi me ventilator

Kur është e mundur, përdorni funksionet e gatimit me ventilator për të kursyer energji.

Nxehtësia e mbetur

Ventilatori dhe llamba vazhdojnë të funksionojnë. Kur fikni furrën, ekrani tregon nxehtësinë e mbetur. Mund ta përdorni këtë nxehtësi për të mbajtur ushqimin e ngrohtë.

Kur gatimi zgjat më shumë se 30 minuta, reduktoni temperaturën e furrës në minimum, 3 - 10 minuta përpara përfundimit të gatimit. Nxehtësia e mbetur brenda furrës do të vazhdojë të gatuajë.

Përdoreni nxehtësinë e mbetur për të ngrohur gatimet e tjera.

Për ta mbajtur ushqimin të ngrohtë

Zgjidhni cilësimin më të ulët të mundshëm të temperaturës për të përdorur nxehtësinë e mbetur dhe për ta mbajtur ushqimin të ngrohtë. Në ekran shfaqet treguesi ose temperatura e nxehtësisë së mbetur.

Gatimi me llambë të fikur

Fikeni llambën gjatë gatimit. Ndizeni vetëm kur t'ju nevojitet.



Pjekje vent. me lagështirë



Funksioni i projektuar për të kursyer energjinë gjatë gatimit.

Kur përdorni këtë funksion llamba fiket automatikisht pas 30 sekondash. Mund ta ndizni llambën sërish, por ky veprim do të reduktojë kursimin e prishëm të energjisë.

14. STRUKTURA E MENYSË

14.1 Menyja



	 - zgjidhni për të hyrë në Menyja.
---	---

Struktura Menyja		
Gatim i asistuar 	Pastrimi 	Cilësimet 

Hapi 1	Hapi 2	Hapi 3	Hapi 4	Hapi 5
 	 OK	 O1 - O11	 OK	
Zgjidhni Menyja, Cilësimet.	Konfirmoni cilësimin.	Zgjidhni cilësimin.	Konfirmoni cilësimin.	Rregulloni vlerën dhe shtypni OK.

Cilësimet					
O1	Ora Ditore	Ndrysho	O2	Drita e ekranit	1 - 5
O3	Tingujt e butonave	1 - Bip 2 - Klik 3 - Tingulli joaktiv	O4	Volumi i ziles	1 - 4
O5	Kohëmatësi me rritje	Ndez / Fik	O6	Të lehta	Ndez / Fik
O7	Nxehje e shpejtë	Ndez / Fik	O8	Kujtuesi i pastrimit	Ndez / Fik
O9	Modaliteti demo	Kodi i aktivizimit: 2468	O10	Versioni i softuerit	Kontroli
O11	Rivendos të gjitha cilësimet	Po / Jo			

15. ÇËSHTJE QË LIDHEN ME AMBIENTIN

Ricikloni materialet me simbolin . Vendoseni ambalazhin te kontejnerët e riciklimit nëse ka. Ndihmoni në mbrojtjen e mjedisit dhe shëndetit të njerëzve dhe në riciklimin e mbetjeve të pajisjeve elektrike dhe elektronike. Mos hidhni pajisjet e shënuara me simbolin  e mbeturinave shtëpiake. Ktheni produktin në pikën lokale të riciklimit ose kontaktoni me zyrën komunale.

ЗА ОТЛИЧНИ РЕЗУЛТАТИ

Благодарим Ви, че избрахте продукт на AEG. Ние го създадохме, за да Ви предоставим безупречна експлоатация в продължение на много години, с иновативни технологии, които правят живота по-лесен – функции, които не можете да откриете при обикновените уреди. Моля, отделете няколко минути за четене, за да извлечете най-доброто. Посетете нашия уебсайт за:



Вижте полезни съвети за употреба, брошури, отстраняване на неизправности, информация за сервиз и ремонт:

www.aeg.com/support



Регистрирайте Вашия продукт за по-добро обслужване:

www.registeraeg.com



Купете аксесоари, консумативи и оригинални резервни части за Вашия уред:

www.aeg.com/shop



За повече рецепти, съвети, отстраняване на неизправности изтеглете приложение **My AEG Kitchen**.



ОБСЛУЖВАНЕ НА КЛИЕНТИ

Винаги използвайте оригинални резервни части.

Когато се свързвате с нашия оторизиран отдел „Обслужване“, трябва да имате под ръка следната информация: Модел, PNC, сериен номер.

Информацията може да бъде открита на табелката с основни данни

 Предупреждение / Внимание – Информация за безопасност

 Обща информация и съвети

 Информация за околната среда

Запазваме си правото на изменения.

СЪДЪРЖАНИЕ

1. ИНФОРМАЦИЯ ЗА БЕЗОПАСНОСТ..... 39	2.7 Обслужване..... 45
1.1 Безопасност за деца и хора в уязвимо положение..... 39	2.8 Изхвърляне..... 45
1.2 Обща безопасност..... 40	3. ОПИСАНИЕ НА УРЕДА..... 45
2. ИНСТРУКЦИИ ЗА БЕЗОПАСНОСТ..... 41	3.1 Общ преглед..... 46
2.1 Инсталация..... 41	3.2 Аксесоари..... 46
2.2 Електрическо свързване..... 42	4. КАК ДА ВКЛЮЧВАТЕ И ИЗКЛЮЧВАТЕ ФУРНАТА..... 47
2.3 Използване..... 43	4.1 Прибиращи се ключове..... 47
2.4 Грижа и почистване..... 44	4.2 Контролен панел..... 47
2.5 Пиролитично почистване..... 44	
2.6 Вътрешно осветление..... 45	

5. ПРЕДИ ПЪРВА УПОТРЕБА.....	48	10.2 Печене с влажност – препоръчителни аксесоари.....	63
5.1 Първоначално почистване.....	48	10.3 Таблици за готвене за изпитващи институции.....	63
5.2 Начално предварително затопляне.....	49	11. ГРИЖИ И ПОЧИСТВАНЕ.....	65
6. ВСЕКИДНЕВНА УПОТРЕБА.....	49	11.1 Бележки относно почистването.....	66
6.1 Как да настроите: Функции нагряване.....	49	11.2 Как се почиства: Вътрешна част на фурната.....	66
6.2 Функции за затопляне.....	50	11.3 Начин на отстраняване: Нносачи на скарата	66
6.3 Бележки относно: Печене с влажност.....	51	11.4 Начин на използване: Пиролитично почистване.....	67
6.4 Как да настроите: Помощ при готвене.....	52	11.5 Напомняне за почистване.....	68
6.5 Помощ при готвене с рецепти....	52	11.6 Как да премахнете и инсталирате: Вратичка.....	68
7. ФУНКЦИИ НА ЧАСОВНИКА.....	58	11.7 Как да подмените: Лампа.....	70
7.1 Функции на часовника.....	58	12. ОТСТРАНЯВАНЕ НА НЕИЗПРАВНОСТИ.....	70
7.2 Как да настроите: Функции на часовника.....	58	12.1 Как да постъпите, ако.....	70
8. КАК ДА СЕ ИЗПОЛЗВА ПРИНАДЛЕЖНОСТИ.....	60	12.2 Данни за обслужване.....	72
8.1 Поставяне на принадлежности... 60		13. ЕНЕРГИЙНА ЕФЕКТИВНОСТ.....	72
9. ДОПЪЛНИТЕЛНИ ФУНКЦИИ.....	61	13.1 Продуктова информация и Продуктов информационен лист*.....	72
9.1 Заключване.....	61	13.2 Енергоспестяваща.....	73
9.2 Автоматично изключване.....	61	14. СТРУКТУРА НА МЕНЮТО.....	74
9.3 Охлаждащ вентилатор.....	62	14.1 Меню.....	74
10. ПРЕПОРЪКИ И СЪВЕТИ.....	62		
10.1 Печене с влажност.....	62		

1. ⚠ ИНФОРМАЦИЯ ЗА БЕЗОПАСНОСТ

Преди монтирането и употребата на уреда внимателно прочетете предоставените инструкции. Производителят не е отговорен за наранявания или повреди в резултат на неправилна инсталация или употреба. Винаги дръжте инструкциите на безопасно и лесно достъпно място за справка в бъдеще.

1.1 Безопасност за деца и хора в уязвимо положение

- Този уред може да бъде използван от деца над 8-годишна възраст, както и от лица с намалени физически,

сетивни и умствени възможности или от лица без опит и познания, само ако те са под наблюдение или бъдат инструктирани относно безопасната употреба на уреда и разбират възможните рискове. Деца под 8-годишна възраст и хора с тежки или комплексни увреждания трябва да се държат далеч от уреда, освен ако не са под постоянно наблюдение.

- Децата трябва да бъдат под наблюдение, за да се гарантира, че не си играят с уреда.
- Дръжте всички опаковки далече от деца и изхвърлете опаковките по местните правила.
- **ПРЕДУПРЕЖДЕНИЕ:** Пазете децата и домашните любимци далече от уреда, когато работи или когато изстива. Има достъпни части, които се нагряват по време на употреба.
- Ако уредът има устройство за детска безопасност, то трябва да се активира.
- Деца не трябва да извършват почистване или поддръжка на уреда, когато са без надзор.

1.2 Обща безопасност

- Само квалифицирано лице трябва да инсталира уреда и да смени кабела.
- Не използвайте уреда, преди да го инсталирате във вградената конструкция.
- Преди извършването на каквато и да е поддръжка, изключете уреда от електрозахранването.
- Ако захранващият кабел е повреден, той трябва да се смени от производителя, негов оторизиран сервизен център или квалифицирано лице, за да се избегне опасност.
- **ВНИМАНИЕ:** Проверете дали уредът е изключен, преди да смените лампичката, за да избегнете възможността от токов удар.

- **ВНИМАНИЕ:** Уредът и неговите достъпни части се нагорещават по време на употреба. Трябва да се внимава и да се избягва докосване на нагревателите.
- Винаги използвайте ръкавици за фурна при изваждане или поставяне на приставки, или съдове за печене.
- За да премахнете мет. държачи във фурната, първо издърпайте предната част на държача и след това задната, за да се разкачи от стените. Поставете мет. държачи в обратна последователност.
- Не почиствайте уреда с парочистачка.
- Не използвайте агресивни, абразивни, почистващи препарати или остри, метални прибори при почистване на стъклото на вратата, тъй като те могат да надраскат повърхността и да доведат до напукване на стъклото.
- Разлетите храни трябва да се отстранят преди пиrolитичното почистване. Свалете всички приставки на фурната.

2. ИНСТРУКЦИИ ЗА БЕЗОПАСНОСТ

2.1 Инсталация

**ВНИМАНИЕ!**

Само квалифициран човек може да извърши монтажа на уреда.

- Махнете всички опаковки.
- Не монтирайте и не използвайте повреден уред.
- Следвайте инструкциите за инсталиране, приложени към уреда.
- Винаги внимавайте, когато местите уреда, тъй като е тежък. Винаги използвайте предпазни ръкавици и затворени обувки.
- Не дърпайте уреда за дръжката.
- Монтирайте уреда на безопасно и подходящо място, което отговаря на монтажните изисквания.
- Трябва да спазвате минималното разстояние до други уреди и устройства.
- Преди да монтирате уреда, проверете дали вратата на фурната се отваря безпроблемно.
- Уредът е оборудван с електрическа система за охлаждане. Трябва да се използва с електрозахранването.
- Вграденият уред трябва да отговаря на изискванията за стабилност на DIN 68930.

ИНСТРУКЦИИ ЗА БЕЗОПАСНОСТ

Минимална височина на отвора за вграждане (Минимална височина на отвора за вграждане под работния плот)	578 (600) мм
Ширина на отвора за вграждане	560 мм
Дълбочина на отвора за вграждане	550 (550) мм
Височина в предната част на уреда	594 мм
Височина в задната част на уреда	576 мм
Ширина в предната част на уреда	595 мм
Ширина в задната част на уреда	559 мм
Дълбочина на уреда	567 мм
Дълбочина на вграждане на уреда	546 мм
Дълбочина при отворена врата	1027 мм
Минимален размер на отвора за вентилация. Отвор разположен в долната задна страна	560 x 20 мм
Дължина на основния захранващ кабел. Кабелът е разположен в десния ъгъл на задната страна	1500 мм
Монтажни винтове	4 x 25 мм

2.2 Електрическо свързване



ВНИМАНИЕ!

Риск от пожар или токов удар.

- Всички ел. връзки трябва да се направят от квалифициран електротехник.
- Уредът трябва да е заземен.
- Уверете се, че параметрите на табелката с технически данни са съвместими с електрическите данни на захранващата мрежа.
- Винаги използвайте правилно монтиран контакт със защита от токов удар.
- Не използвайте разклонители или адаптери с много входове.
- Внимавайте да не повредите захранващия щепсел и захранващия кабел. Ако захранващият кабел трябва да бъде подменен, това трябва да бъде извършено от нашия оторизиран сервизен център.
- Не допускайте захранващите кабели да се доближават до вратичката на уреда или пространството под него, особено когато е включен или когато вратичката е гореща.

- Защитата от токов удар на горещите и изолирани части трябва да бъде затегната по такъв начин, че да не може да се отстрани без инструменти.
- Свържете кабела за хранването към контакта единствено в края на инсталацията. Уверете се, че щепселът за хранване е достъпен след инсталирането.
- Ако контактът е разхлабен, не свързвайте хранващия щепсел.
- Не издърпвайте хранващия кабел, за да изключите уреда. Винаги издърпвайте щепсела на хранването.
- Използвайте само правилни устройства за изолация: предпазни прекъсвачи на мрежата, предпазители (предпазителите от винтов тип трябва да се извадят от фасунгата), изключватели и контактори за утечка на заземяването.
- Електрическата инсталация трябва да има изолиращо устройство, което Ви позволява да изключите уреда от ел. мрежата при всички полюси. Изолиращото устройство трябва да е с ширина на отваряне на контакта минимум 3 мм.
- Затворете изцяло вратичката на уреда, преди да свържете хранващия кабел към контакта.
- Този уред се доставя с електрохранващи щепсел и кабел.

2.3 Използване



ВНИМАНИЕ!

Риск от нараняване, изгаряния, токов удар или експлозия.

- Този уред е предназначен само за домашна (на закрито) употреба.
- Не променяйте предназначението на уреда.
- Уверете се, че вентилационните отвори не са блокирани.
- Не оставяйте уреда без надзор по време на работа.
- Изключвайте уреда след всяко използване.
- Бъдете внимателни, когато отваряте вратата на уреда, докато уредът работи. Може да излезе горещ въздух.
- Не работете с уреда с мокри ръце или когато има контакт с вода.
- Не оказвайте натиск върху отворената врата.
- Не използвайте уреда като работна повърхност или повърхност за съхранение.
- Отваряйте внимателно вратата на уреда. Използването на съставки с алкохол може да предизвика смесване на алкохол и въздух.
- Не позволявайте искри или открит пламък да влизат в контакт с уреда, когато отваряте вратата.
- Не поставяйте запалими продукти или предмети, които са намокрени със запалими продукти, в близост до уреда или върху него.



ВНИМАНИЕ!

Опасност от повреда в уреда.

- За да се избегнат повреди и обезцветяване на емайла:
 - не поставяйте съдове за фурна или други предмети в уреда директно върху дъното.
 - не поставяйте алуминиево фолио директно върху дъното на уреда.
 - не поставяйте вода директно в горещия уред.
 - не поставяйте влажни съдове и храна в уреда, след като приключите с готвенето.
 - бъдете внимателни, когато махате или поставяте аксесоарите.
- Обезцветяването на емайла или неръждаемата стомана не оказва влияние върху работата на уреда.

ИНСТРУКЦИИ ЗА БЕЗОПАСНОСТ

- Използвайте дълбока тава за влажни торти. Плодовите сокове причиняват петна, които могат да бъдат трайни.
- Този уред е предназначен само за готвене. Той не трябва да се използва за други цели, например за отопление на помещението.
- Винаги гответе със затворена врата на фурната.
- Ако уредът е инсталиран зад преграда от мебелен тип, напр. зад вратичка в шкаф, тази вратичка трябва винаги да е отворена, докато уредът работи. Ако е затворена, могат да се акумулират топлина и влага, които впоследствие да повредят уреда, шкафа или пода. Не затваряйте преградата, докато уредът не изстине напълно след употреба.

2.4 Грижа и почистване



ВНИМАНИЕ!

Опасност от нараняване, пожар или повреда на уреда.

- Преди поддръжка изключете уреда и извадете щепсела на захранването от контакта на ел. мрежата.
- Уверете се, че уредът е студен. Има опасност стъклените панели да се счупят.
- Сменяйте незабавно стъклените панели на вратичката, когато са повредени. Свържете се с оторизиран сервизен център.
- Внимавайте, когато сваляте вратичката от уреда. Вратичката е тежка!
- Почиствайте редовно уреда, за да предотвратите разваляне на повърхностния материал.
- Почистете уреда с мокра и мека кърпа. Използвайте само неутрални препарати. Не използвайте абразивни продукти, грапави, почистващи кърпи, разтворители или метални предмети.
- Ако използвате спрей за фурна, следвайте инструкциите за безопасност върху опаковката му.

2.5 Пиролитично почистване



ВНИМАНИЕ!

Опасност от нараняване / пожар / химически емисии (пушек) в пиролитичен режим.

- Преди извършване на функцията за пиролитично самопочистване или функцията за първа употреба, моля отстранете от вътрешността на фурната:
 - всички излишни хранителни остатъци, масло или разлетели мазнини / отлагания.
 - всички подвижни предмети (включително скари, странични шини и т.н., доставени с продукта) и по-специални всички незалепващи тенджери, тигани, тави, посуда и др.
- Прочетете внимателно всички инструкции за пиролитичното почистване.
- Деца не бива да до уреда, докато тече пиролитичното почистване. Уредът става много горещ и от предните отвори за охлаждане се изпуска горещ въздух.
- Пиролитичното почистване е операция с висока температура, която може да предизвика освобождаването на изпарения от остатъци от готвене и строителни материали, препоръчително е потребителите да:
 - осигурят добра вентилация по време и след всяко пиролитичното почистване.
 - осигурят добра вентилация по време и след първата употреба при работа на максимална температура.

- За разлика от хората, някои птици или влечуги са изключително чувствителни към потенциални изпарения, които се отделят по време на процеса на почистване на всички фурни с пиролиза.
 - Премахнат всички домашни животни (особено птици), които са в близост до уреда по време на и след пиролитичното почистване и първо използване при максимална температура на добре проветрено място.
- Малките домашни любимци също могат да бъдат много чувствителни към локалните промени в температурата около всички фурни с пиролиза, когато програмата за пиролитично самопочистване работи.
- Незалепващите покрития върху тенджери, тигани, тави, прибори и т.н., могат да бъдат повредени по време на пиролитично почистване при висока температура на всички фурни с пиролиза и също така могат да бъдат източник на ниски нива на вредни изпарения.
- Изпарения, излъчени от фурни с пиролиза / остатъци от храна, както е описано, не са вредни за хора, в това число деца и хора със здравословни проблеми.

2.6 Вътрешно осветление



ВНИМАНИЕ!

Опасност от токов удар.

- Относно лампата(ите) вътре в този продукт и резервните лампи, продавани отделно: Тези лампи са предназначени да издържат на екстремни физически условия в домакински уреди, като температура, вибрации, влажност или са предназначени да сигнализират информация за работното състояние на уреда. Те не са предназначени за използване в други приложения и не са подходящи за осветяване на помещения в домакинството.
- Използвайте само лампи със същите спецификации.

2.7 Обслужване

- За поправка на уреда се свържете с оторизиран сервизен център.
- Използвайте само оригинални резервни части.

2.8 Изхвърляне



ВНИМАНИЕ!

Риск от нараняване или задушаване.

- Изключете уреда от електрозахранването.
- Извадете захранващия ел. кабел в близост до уреда и го изхвърлете.
- Премахнете дръжката на вратичката, за да предотвратите заклещването на деца, или домашни любимци в уреда.

3. ОПИСАНИЕ НА УРЕДА

3.1 Общ преглед

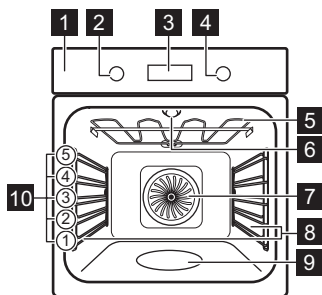

- 1** Контролен панел
- 2** Копче за функциите за нагриване
- 3** Екран
- 4** Копче за управление
- 5** Нагриващ елемент
- 6** Лампа
- 7** Вентилатор
- 8** Водачи за скара, отстраняеми
- 9** Позиция на скара
- 10** Вътрешна част на фурната

3.2 Аксесоари

Скара/рафт

За съдове за готвене, тави за торти и печене.

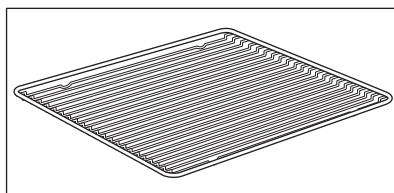

Тава за печене

За торти и бисквити.

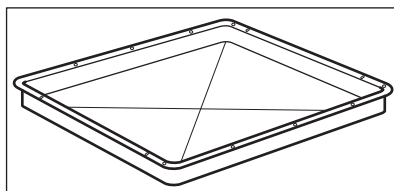

КАК ДА ВКЛЮЧВАТЕ И ИЗКЛЮЧВАТЕ ФУРНАТА

Съд за грил / печене

За печене или като тиган за събиране на мазнина.

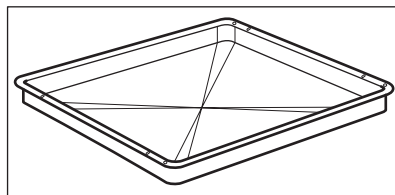

Телескопични водачи

За лесно поставяне и изваждане на тавите и скарата.

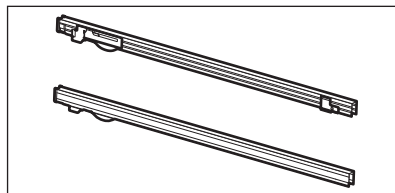







4. КАК ДА ВКЛЮЧВАТЕ И ИЗКЛЮЧВАТЕ ФУРНАТА

4.1 Прибиращи се ключове

За да използвате уреда, натиснете ключа. Ключът излиза.

4.2 Контролен панел

Сензорни полета на панела за управление					Натиснете	Завъртете ключа
 Таймер	 Бързо нагряване	 Осветление	 Заклучване	OK		

Изберете функция за нагряване, за да включите фурната.

Завъртете ключа за функциите за нагряване в изключена позиция, за да изключите фурната.

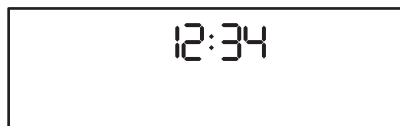

Когато ключът за функциите за нагряване е в изключена позиция, екранът става в режим на готовност.

ПРЕДИ ПЪРВА УПОТРЕБА

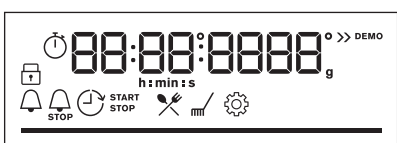
	Когато готвите, екранът показва зададените температура, час от деня и други налични опции.
	Екранът с максимален брой зададени функции.

Индикатори на екрана

 Заклучване	 Помощ при готвене	 Почистване	 Настройки	 Бързо нагряване
Индикатори на таймера:				





Лента да напредъка - за температура или час.	
--	---

Индикатор за готвене с пара	
-----------------------------	---

5. ПРЕДИ ПЪРВА УПОТРЕБА

 ВНИМАНИЕ! Вж. глава "Безопасност".

5.1 Първоначално почистване

Преди първата употреба почистете празната фурна и задайте час.			
			 00:00 Настройте таймера. Натиснете: OK

5.2 Начално предварително затопляне



Затоплете предварително празната фурна преди първата употреба.

Стъпка 1

Извадете от фурната всички принадлежности и подвижните опори на скарата.

Стъпка 2

Задайте максималната температура за функцията: .
Оставете фурната да работи за 1 час.

Стъпка 3

Задайте максималната температура за функцията: .
Оставете фурната да работи за 15 мин.

 От фурната може да излиза миризма и дим по време на предварителното затопляне. Уверете се, че стаята е проветрена.

6. ВСЕКИДНЕВНА УПОТРЕБА



ВНИМАНИЕ!

Вж. глава "Безопасност".

6.1 Как да настроите: Функции нагряване

Започнете да готвите

Стъпка 1



Задайте функция за затопляне.

Стъпка 2



Задайте температурата.

Готвене на пара

Уверете се, че фурната е студена.

Стъпка 1

Стъпка 2

Стъпка 3

Стъпка 4

Готвене на пара



			<p>Оставете празната фурна да загрее предварително в продължение на 10 минути, за да се образува влага. Поставете я във фурната.</p>
<p>Напълнете релефа във вътрешността с чешмяна вода.</p>	<p>Изберете функцията на затопляне на пара.</p>	<p>Задайте температурата.</p>	
<p>i Максималната вместимост на релефа във вътрешността е 250 мл. Не пълнете отново релефа във вътрешността по време на готвене или когато фурната е гореща.</p>			









Когато готвенето на пара приключи:

Стъпка 1	Стъпка 2	Стъпка 3
<p>Завъртете ключа за функциите за нагряване в изключена позиция, за да изключите фурната.</p>	<p>Отворете вратата внимателно. Освободената влажност може да предизвика изгаряния.</p>	<p>Уверете се, че фурната е студена. Отстранете остатъчната вода от релефа във вътрешността.</p>

6.2 Функции за затопляне

Стандартни функции за нагряване

Функция за затопляне	Приложение
 <p>Горещ въздух/вентилир</p>	<p>За печене на три нива едновременно и за сушене на храна. Задайте температура с 20 - 40°C по-ниска отколкото за Традиционно печене.</p>
 <p>Традиционно печене</p>	<p>За печене на тестени и месни храни на едно ниво.</p>

Функция за затопляне	Приложение
 SteamBake	За добавяне на влажност по време на готвене. За получаване на правилния цвят и хрупкава коричка по време на печене. За повече сочност при претопляне. За консервиране на плодове и зеленчуци.
 Функция пица	За печене на пица. За хрупкав и запечен блат.
 Долен нагревател	За печене на сладкиши с хрупкава долна част и за запазване на храната.
 Дълбоко замразени храни	За да станат хрупкави полуготовите храни (напр. картофки, картофи с коричка или пролетни ролца).
 Печене с влажност	Функцията е разработена за пестене на енергия по време на готвене. Когато използвате тази функция, температурата във вътрешността може да се различава от зададената. Използва се остатъчната топлина. Степента на нагриване може да бъде намалена. За повече информация вижте глава „Всекидневна употреба“, забележете: Печене с влажност.
 Грил	За запичане на тънки храни или препичане на хляб.
 Турбо грил	За печене на големи парчета месо или птици с костите на едно ниво. За огретени и за кафява коричка.
 Меню	За да влезете в Менюто: Помощ при готвене, Почистване, Настройки.

6.3 Бележки относно: Печене с влажност





Тази функция беше използвана за спазване на изискванията за клас на енергийна ефективност и екодизайн според ЕС 65/2014 и ЕС 66/2014. Тестове съгласно EN 60350-1. Вратата на фурната трябва да се затвори по време на готвене, така че функцията да не се прекъсва и да се гарантира, че фурната работи с възможно най-висока енергийна ефективност.

Когато използвате тази функция, лампичката автоматично се изключва след 30 секунди.



За инструкции за готвене вижте глава „Съвети“, Печене с влажност. За общи препоръки относно пестене на енергия вижте глава „Енергийна ефективност“, Пестене на енергия.

6.4 Как да настроите: Помощ при готвене

Всяко ястие в това подменю има препоръчителна функция и температура. Можете да настроите часа и температурата по време на готвене.

Помощ при готвене - използвайте го, за да пригответе бързо дадено ястие с настройка по подразбиране:			
Стъпка 1	Стъпка 2	Стъпка 3	Стъпка 4
			
Влезте в менюто.	Изберете Помощ при готвене. Натиснете OK .	Изберете ястието. Натиснете: OK	Поставете ястието във фурната. Потвърдете настройката.

6.5 Помощ при готвене с рецепти

Легенда	
	Количеството вода за функцията за пара.
	Загрейте предварително фурна преди да започнете да готвите.
	Ниво на скарата.











Когато функцията приключва, проверете дали храната е готова.

	Ястие	Тегло	Ниво на скарата/Аксесоари	Времетраене
Говеждо 				





















	Ястие	Тегло	Ниво на скарата/Аксесоари	Времетраене
P1	Говеждо печено, алангле	1 - 1,5 кг; парчета с дебелина 4 - 5 см	☐ 2; тава за печене Запържете месото за няколко минути в горещ тиган. Поставете го във фурната.	40 мин.
P2	Говеждо печено, средно изпечено			50 мин.
P3	Говеждо печено, добре изпечено			60 мин.
P4	Пържола, средно изпечена	180 - 220 гр парче; парчета с дебелина 3 см	☒ ☐ 3; печене на ястието на скара Запържете месото за няколко минути в горещ тиган. Поставете го във фурната.	15 мин.
P5	Печено/Задушено говеждо (основно ребро, горен кръг, дебела сланина)	1,5 – 2 кг	☐ 2; печене на ястието на скара Запържете месото за няколко минути в горещ тиган. Добавете течност. Поставете го във фурната.	120 мин.
P6	Печено говеждо, алангле (бавно готвене)	1 - 1,5 кг; парчета с дебелина 4 - 5 см	☐ 2; тава за печене Използвайте любимите си подправки или само сол и прясно смлян пипер. Запържете месото за няколко минути в горещ тиган. Поставете го във фурната.	75 мин.
P7	Печено говеждо, средно изпечено (бавно готвене)			85 мин.
P8	Печено говеждо, добре изпечено (бавно готвене)			130 мин.

















ВСЕКИДНЕВНА УПОТРЕБА

	Ястие	Тегло	Ниво на скарата/Аксесоари	Времетраене
P9	Филе, алангле (бавно готвене)	0,5 - 1,5 кг; парчета с дебелина 5 - 6 см	☒ 2; тава за печене Използвайте любимите си подправки или само сол и прясно смлян пипер. Запържете месото за няколко минути в горещ тиган. Поставете го във фурната.	75 мин.
P10	Филе, средно изпечено (бавно готвене)			90 мин.
P11	Филе, изпечено (бавно готвене)			120 мин.
Телешко 🍖				
P12	Печено телешко (на пр., плешка)	0,8 - 1,5 кг; парчета с дебелина 4 см	☒ 2; печене на ястието на скара Използвайте любимите си подправки. Добавете течност. Покрито печено.	80 мин.
Свинско 🍖 🍖				
P13	Печен свински врат или плешка	1,5 - 2 кг	☒ 2; печена на ястието на скара След половината от времето за готвене обърнете месото.	120 мин.
P14	Дърпано свинско LTC	1,5 - 2 кг	☒ 2; тава за печене Използвайте любимите си подправки. След половината от времето за готвене обърнете месото, за да получи равномерен златист цвят.	215 мин.
P15	Бонфиле, прясно	1 - 1,5 кг; парчета с дебелина 5 - 6 см	☒ 2; печене на ястието на скара Използвайте любимите си подправки.	55 мин.







	Ястие	Тегло	Ниво на скарата/Акcesoари	Времетраене
P16	Свински ребра	2 - 3 кг; използвайте сурови, свински ребра с дебелина 2 - 3 см	 3; дълбок тиган Добавете течност, за да покриете дъното на ястието. След половината от времето за готвене обърнете месото.	90 мин.
Агнешко 				
P17	Агнешки бут с кост	1,5 - 2 кг; парчета с дебелина 7 - 9 см	 2; печете ястието в тава за печене Добавете течност. След половината от времето за готвене обърнете месото.	130 мин.
Птиче месо 				
P18	Цяло пиле	1 - 1,5 кг; прясно	 2;  200 мл; касерол в тава за печене Използвайте любимите си подправки. След половината от времето за готвене обърнете пилето, за да получи равномерен златист цвят.	60 мин.
P19	Половин пиле	0,5 - 0,8 кг	 3; тава за печене Използвайте любимите си подправки.	40 мин.
P20	Пилешки фенер	180 - 200 гр. парче	  2; каресол на скара Използвайте любимите си подправки. Запържете месото за няколко минути в горещ тиган.	25 мин.
P21	Пилешки бутчета, пресни	-	 3; тава за печене Ако първо маринувате пилешките бутчета, задайте по-ниска температура и гответе по-дълго.	30 мин.
P22	Патица, цяла	2 - 3 кг	 2; печене на ястието на скара Използвайте любимите си подправки. Поставете месото в съд за печене. След половината от времето за готвене обърнете патицата.	100 мин.

ВСЕКИДНЕВНА УПОТРЕБА

	Ястие	Тегло	Ниво на скарата/Аксесоари	Времетраене
P23	Гъска, цяла	4 - 5 кг	 2; дълбок тиган Използвайте любимите си подправки. Поставете месото в дълбока тава за печене. След половината от времето за готвене обърнете гъската.	110 мин.
Друго 				
P24	Руло „Стефани“	1 кг	 2; скара Използвайте любимите си подправки.	60 мин.
Риба 				
P25	Цяла риба, на грил	0,5 - 1 кг риба	 2 ; тава за печене Напълнете рибата с масло и използвайте любимите си подправки и билки.	30 мин.
P26	Филе от риба	-	  3; касерол на скара Използвайте любимите си подправки.	20 мин.
Сладки печива / десерти   				
P27	Чийзкейк	-	 2;  28 см форма за торта на скара	90 мин.
P28	Ябълков кейк	-	 2;  100 - 150 мл; тава за печене	60 мин.
P29	Ябълков тарт	-	 2; форма за пай на скара	40 мин.
P30	Ябълков пай	-	 2;  100 - 150 мл;  22 см форма за пай на скара	60 мин.
P31	Брауни	2 кг	 3; дълбок тиган	30 мин.
P32	Шоколадови мъфини	-	 2;  100 - 150 мл; форма за мъфини на скара	30 мин.





	Ястие	Тегло	Ниво на скарата/Аксесоари	Времетраене
P33	Кейк с хляб-на форма	-	 2; форма за хляб на скара	50 мин.
Зеленчуци/Гарнитури 				
P34	Печени картофи	1 кг	 2; тава за печене Поставете цели картофи с обелката в тава за печене.	50 мин.
P35	Картофи с коричка	1 кг	 3; тава за печене с поставена хартия за печене Използвайте любимите си подправки. Нарезете картофите на парчета.	35 мин.
P36	Гриловани смесени зеленчуци	1 - 1,5 кг	 3; тава за печене с поставена хартия за печене Използвайте любимите си подправки. Нарезете зеленчуците на парчета.	30 мин.
P37	Крокети, замразени	0,5 кг	 3; тава за печене	25 мин.
P38	Пържени картофи, замразени	0,75 кг	 3; тава за печене	25 мин.
Огретени, хляб и пица 				
P39	Лазаня/Касерол с нудли	1 - 1,5 кг	 2; касерол на скара	45 мин.
P40	Запечени картофи	1 - 1,5 кг	 1; касерол на скара	50 мин.
P41	Прясна пица, тънка	-	  2;  100 мл; тава за печене с поставена хартия за печене	15 мин.
P42	Прясна пица, дебела	-	  2;  100 мл; тава за печене с поставена хартия за печене	25 мин.
P43	Киш	-	 2; тава за печене на скара	45 мин.

ФУНКЦИИ НА ЧАСОВНИКА

	Ястие	Тегло	Ниво на скарата/Аксесоари	Времетраене
P44	Багета/Чабата/Бял хляб	0,8 кг	  3;  150 мл; тава за печене с поставена хартия за печене За бял хляб е необходимо повече време.	30 мин.
P45	Всички пълнозърнести зърнени/ржени/тъмни хлябове във форма за хляб	1 кг	  2;  150 мл; тава за печене поставена хартия за печене / скара	45 мин.

7. ФУНКЦИИ НА ЧАСОВНИКА

7.1 Функции на часовника

Функция „Часовник“	Приложение
	Таймер. Когато таймерът приключи се чува сигнал.
	Време за готвене. Когато таймерът приключи се чува сигнал и функцията за нагряване спира.
	Отложен старт. За отлагане на старта и/или края на готвенето.
	Брояч. Максимумът е 23 ч. и 59 мин. Тази функция не влияе върху работата на фурната. За да включите или изключите Брояч , изберете: Меню, Настройки.

7.2 Как да настроите: Функции на часовника





Как да настроите: Час от денонощието		
Стъпка 1	Стъпка 2	Стъпка 3
		

ФУНКЦИИ НА ЧАСОВНИКА

Как да настроите: Час от денонощието





<p>За да промените часа от денонощието, влезте в менюто и изберете Настройки, Час от денонощието.</p>	<p>Настройте часовника.</p>	<p>Натиснете: OK.</p>
---	-----------------------------	-----------------------

Как да настроите: Таймер

Стъпка 1		Стъпка 2	Стъпка 3
	<p>На екрана се показва: 0:00</p> 		
<p>Натиснете: .</p>		<p>Настройте Таймер</p>	<p>Натиснете: OK.</p>

Таймерът  започва да отброява веднага.









Как да настроите: Време за готвене

Стъпка 1	Стъпка 2		Стъпка 3	Стъпка 4
		<p>На екрана се показва: 0:00</p> 		
<p>Изберете функция за затопляне и настройте температурата.</p>	<p>Натиснете няколко пъти: .</p>		<p>Задайте времето за готвене.</p>	<p>Натиснете: OK.</p>

Таймерът  започва да отброява веднага.

КАК ДА СЕ ИЗПОЛЗВА ПРИНАДЛЕЖНОСТИ

Как да настроите: Отложен старт

Стъпка 1	Стъпка 2		Стъпка 3	Стъпка 4		Стъпка 5	Стъпка 6
		На екрана се показва: часът от денонощието			На екрана се показва:		
Изберете функцията за затопляне.	Натиснете няколко пъти: 	нощието  СТАРТ	Настройте време за начало.	Натиснете: ОК.	--:--  СТОП	Настройте време за край.	Натиснете: ОК.

Таймерът  започва да отброява съгласно настроеното време за начало.

8. КАК ДА СЕ ИЗПОЛЗВА ПРИНАДЛЕЖНОСТИ

8.1 Поставяне на принадлежности

Малката вдлъбнатина отгоре увеличава безопасността. Вдлъбнатините са също така средства против преобръщане. Високият ръб около шкафа предотвратява изплъзването на готварски съдове.

Скара/рафт:



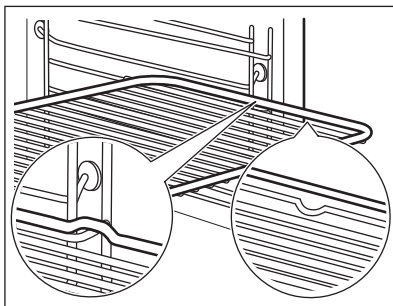

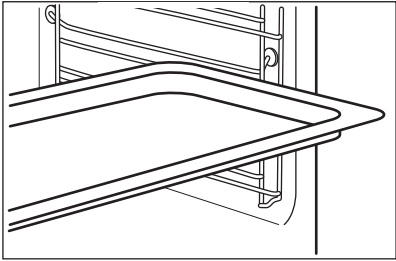
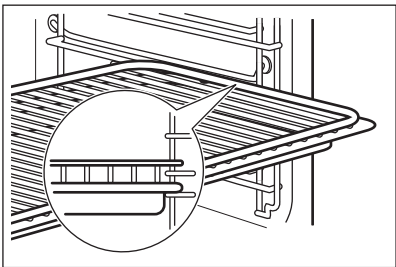

Вкарайте скарата между водачите на опорите ѝ.



<p>Тава за печене /Дълбока тава: Натиснете тавата между водачите на опората на скарата.</p>	
<p>Скара/рафт, Тава за печене /Дълбока тава: Плъзнете тавата между водачите на опората на скарата и решетъчната скара на водачите отгоре.</p>	

9. ДОПЪЛНИТЕЛНИ ФУНКЦИИ



9.1 Заклучване

<p>Тази функция предотвратява случайна промяна на работата на фурната.</p>		
<p>Включете я, когато фурната работи - зададеното готвене продължава, контролният панел е заключен. Включете я, когато фурната е изключена - фурната не може да бъде включена, контролният панел е заключен.</p>		
 	<p> - натиснете и задръжте, за да включите функцията. Прозвучава сигнал.</p>	<p> - натиснете и задръжте, за да я изключите.</p>
<p> 3 x  - премигва, когато заключването е включено.</p>		

9.2 Автоматично изключване

От съображения за безопасност фурната се изключва автоматично след известно време, ако е включена функцията за затопляне, а настройките не са променени.

ПРЕПОРЪКИ И СЪВЕТИ

 (°C)	 (h)
30 - 115	12.5
120 - 195	8.5
200 - 245	5.5
250 - максимум	3

Автоматичното изключване не действа при следните функции: Осветление, Отложен старт.



9.3 Охлаждащ вентилатор

Когато фурната работи, охлаждащият вентилатор се включва автоматично, за да поддържа повърхностите на фурната хладни. Ако изключите фурната, вентилаторът за охлаждане може да продължи да работи, докато фурната се охлади.

10. ПРЕПОРЪКИ И СЪВЕТИ

10.1 Печене с влажност

За най-добри резултати следвайте предложенията в долната таблица. Използвайте позицията на третия рафт.

	 (°C)	 (min)
Огретен с паста	200 - 220	45 - 55
Запечени картофи	180 - 200	70 - 85
Мусака	170 - 190	70 - 95
Лазаня	180 - 200	75 - 90
Канелони	180 - 200	70 - 85
Хлебен пудинг	190 - 200	55 - 70
Ориз пудинг	170 - 190	45 - 60

	 (°C)	 (min)
Ябълков кейк с пандишпанова торта (кръгла форма за сладкиши)	160 - 170	70 - 80
Бял хляб	190 - 200	55 - 70

10.2 Печене с влажност – препоръчителни аксесоари







Използвайте тъмни, неотразяващи фолия и съдове. Те абсорбират топлина по-добре от светлите и отразителни съдове.

 Тава за пица	 Съд за печене	 Купички за печене	 Метална основа за флан
Тъмен, неотразяващ материал 28 cm диаметър	Тъмен, неотразяващ материал 26 cm диаметър	Керамичен материал 8 cm диаметър, 5 cm височина	Тъмен, неотразяващ материал 28 cm диаметър

10.3 Таблици за готвене за изпитващи институции.

Информация за изпитващи лаборатории





Изпитвания съгласно: EN 60350, IEC 60350.

 ПЕЧЕНЕ НА ЕДНО НИВО. Печене в плитка тава				
		 (°C)	 (min)	
Пандишпанова торта без мазнина	Горещ въздух/вентилатор	140 - 150	35 - 50	2
Пандишпанова торта без мазнина	Традиционно печене	160	35 - 50	2

ПРЕПОРЪКИ И СЪВЕТИ



ПЕЧЕНЕ НА ЕДНО НИВО. Печене в плитка тава





		 (°C)	 (min)	
Ябълков пай, 2 тави Ø20 cm	Горещ въздух/ вентилир	160	60 - 90	2
Ябълков пай, 2 тави Ø20 cm	Традиционно пече- не	180	70 - 90	1



ПЕЧЕНЕ НА ЕДНО НИВО. Бисквити







Използвайте позицията на третия рафт.

		 (°C)	 (min)
Масленки / Сладкиши на пръчици	Горещ въздух/вентилир	140	25 - 40
Масленки / Сладкиши на пръчици, подгрейте праз- ната фурна	Традиционно печене	160	20 - 30
Малки кейкове 20 броя/ табла, подгрейте празна- та фурна	Горещ въздух/вентилир	150	20 - 35
Малки кейкове 20 броя/ табла, подгрейте празна- та фурна	Традиционно печене	170	20 - 30



ПЕЧЕНЕ НА НЯКОЛКО НИВА. Бисквити

		 (°C)	 (min)	
Масленки / Сладкиши на пръчици	Горещ въздух/вентил	140	25 - 45	1 / 4
Малки кейкове 20 броя/табла, подгрейте празната фурна	Горещ въздух/вентил	150	23 - 40	1 / 4
Пандишпанова торта без мазнина	Горещ въздух/вентил	160	35 - 50	1 / 4







ЕДИНИЧЕН ГРИЛ



Загрейте празната фурна предварително за 5 минути.



Гриловайте на максималната температура.

		 (min)	
Тост	Грил	1 - 3	5
Говежда пържола, обърнете по средата на времето за приготвяне	Грил	24 - 30	4

11. ГРИЖИ И ПОЧИСТВАНЕ





ВНИМАНИЕ!

Вж. глава "Безопасност".

11.1 Бележки относно почистването

 Препарати за почистване	Почистете лицевата част на фурната с мека кърпа с топла вода и лек препарат за почистване.
	Използвайте почистващ разтвор, за да почистите металните повърхности.
	Почистете петната с лек почистващ препарат.

 Всекидневна употреба	Почиствайте вътрешността след всяка употреба. Натрупвания на мазнини или други остатъци могат да доведат до пожар.
	Не съхранявайте храната във фурната за повече от 20 минути. Подсушавайте вътрешността на фурната с мека кърпа след всяка употреба.

 Акcesoари	Почиствайте принадлежностите на фурната след всяко ползване и ги оставяйте да изсъхнат. Използвайте мека кърпа с топла вода и лек почистващ препарат. Не почиствайте принадлежностите в съдомиялна.
	Не почиствайте незалепващите акcesoари с абразивно почистващо средство или предмети с остри ръбове.

11.2 Как се почиства: Вътрешна част на фурната

Почистете релефа на вътрешността, за да отстраните остатъци от варовик след готвене с пара.

Стъпка 1	Стъпка 2	Стъпка 3
Налейте: 250 мл бял оцет в релефа на вътрешността на фурната. Използвайте максимум 6% оцет без добавки.	Оставете оцета да разтвори остатъчния варовик на стойна температура за 30 минути.	Изчистете вътрешността с топла вода и мека кърпа.
За функцията: SteamBake почиствайте фурната на всеки 5-10 цикъла на готвене.		

11.3 Начин на отстраняване: Нносачи на скарата

Отстранете опорите на скарата, за да почистите фурната.

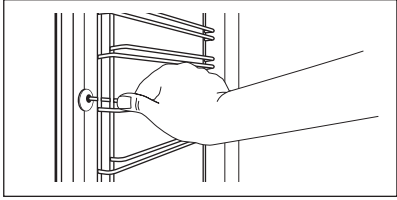
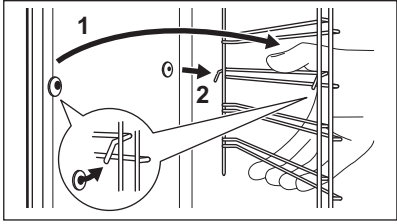
Стъпка 1	Изключете фурната и изчакайте да изстине.	
Стъпка 2	Издърпайте предната част на опорите на скарата от страничната стена.	
Стъпка 3	Издърпайте задната част на носачите на скарата от стената и я извадете.	
Стъпка 4	Поставете носачите на скарата в обратна последователност. Задържащите щифтове на телескопичните водачи трябва да са обърнати напред.	

11.4 Начин на използване: Пиролитично почистване

Почистете фурната с Пиролитично почистване.



ВНИМАНИЕ!

Има риск от изгаряния.



ПРЕДУПРЕЖДЕНИЕ!



Ако в същия шкаф има монтирани други уреди, не ги използвайте едновременно с тази функция. Това може да причини повреда на фурната.

Преди Пиролитично почистване:

Изключете фурната и изчакайте да изстине.	Отстранете всички аксесоари и подвижни скари.	Почистете пода на фурната и вътрешното стъкло на вратата с топла вода, мека кърпа и умерен почистващ препарат.
---	---	--

Пиролитично почистване

Стъпка 1	Влезте в менюто: Почистване ml .	
	Опция	Времетраене
	C1 - Леко почистване	1 h
	C2 - Нормално почистване	1 h 30 min

Пиролитично почистване	
С3 - Цялостно почистване	3 h
Стъпка 2	OK – натиснете, за да изберете програмата за почистване.
Стъпка 3	OK – натиснете, за да започнете почистването.
Стъпка 4	След почистване завъртете ключа за функциите за затопляне на изключена позиция.
<p> По време на почистването лампичката на фурната е изключена.</p> <p>Когато фурната достигне зададената температура, вратичката се блокира. Докато вратата се отключи, дисплеят показва: .</p>	

Когато чистенето приключи:		
Изключете фурната и изчакайте да изстине.	Изчистете вътрешността с мека кърпа.	Премахнете остатъка от дъното на вътрешността.

11.5 Напомняне за почистване

Фурната Ви напомня кога да я почистите с пиролитично почистване.	
 мига на екрана за 5 секунди след всяко готвене.	За да изключите напомнянето, влезте в Меню и изберете Настройки, Напомняне за почистване.

11.6 Как да премахнете и инсталирате: Вратичка

Можете да отстраните вратата и вътрешните стъклени панели, за да ги почистите. Номерът на стъклените панели е различен за различните модели.

	ВНИМАНИЕ! Вратата е тежка.
--	--------------------------------------

	ПРЕДУПРЕЖДЕНИЕ! Подхождайте с внимание, когато почиствате стъклото, особено около ръбовете на предния панел. Стъклото може да се счупи.
--	---

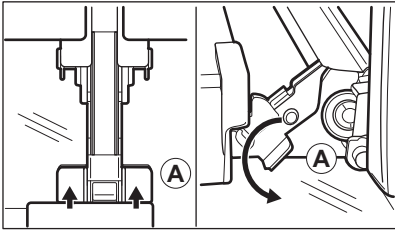
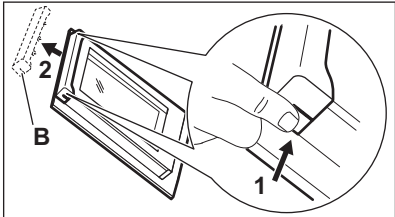
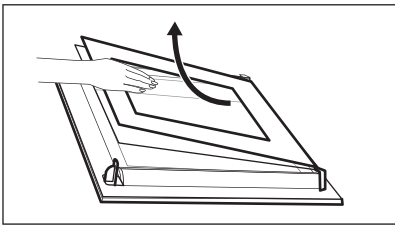
Стъпка 1	Отворете вратата изцяло.	
Стъпка 2	Повдигнете и натиснете закрепващите лостчета (A) на двете панти на вратичката.	
Стъпка 3	Затворете вратичката на фурната до първото възможно положение за отваряне (под ъгъл от около 70°). Задръжте вратичката от двете страни и я отстранете от фурната под ъгъл нагоре. Поставете вратичката с външната страна надолу върху мека кърпа на стабилна повърхност.	
Стъпка 4	Хванете рамката в горната част на вратата (B) от двете ѝ страни и натиснете навътре, за да освободите езичето.	
Стъпка 5	Издърпайте рамката на вратичката към себе си, за да я извадите.	
Стъпка 6	Хванете стъклените панели в горния край един по един и ги извадете нагоре от водачите.	
Стъпка 7	Почистете стъкления панел с вода и сапун. Внимателно подсушете стъкления панел. Не почиствайте стъклените панели в съдомиялна машина.	
Стъпка 8	След почистване изпълнете горните стъпки в обратна последователност.	
Стъпка 9	Поставете първо по-малкия панел, после по-големия и вратичката. Уверете се, че стъклата са поставени на правилните места, иначе повърхността на вратичката може да прегрее.	

ОТСТРАНЯВАНЕ НА НЕИЗПРАВНОСТИ

11.7 Как да подмените: Лампа



ВНИМАНИЕ!

Опасност от токов удар.
Лампата може да е гореща.

Преди да смените лампата:

Стъпка 1	Стъпка 2	Стъпка 3
Изключете фурната. Изчаквайте, докато фурната изстине.	Изключете фурната от електрическата мрежа.	Поставете парче плат върху дъното на фурната.

Горна лампа

Стъпка 1	Завъртете стъкления капак, за да го извадите.	
Стъпка 2	Почистете стъкления капак.	
Стъпка 3	Сменете старата крушка с подходяща нова крушка, устойчива на температура 300°C.	
Стъпка 4	Монтирайте стъкления капак.	

12. ОТСТРАНЯВАНЕ НА НЕИЗПРАВНОСТИ



ВНИМАНИЕ!

Вж. глава "Безопасност".

12.1 Как да постъпите, ако...

За случаите, които липсват в таблицата, моля, свържете се с оторизиран сервиз.



Фурната не се включва или не загрева

Проблем	Проверете дали...
---------	-------------------

ОТСТРАНЯВАНЕ НА НЕИЗПРАВНОСТИ



Фурната не се включва или не загрева

Не можете да активирате или работите с фурната.	Фурната е правилно свързана към електрозахранването.
Фурната не се затопля.	Автоматичното изключване е деактивирано.
Фурната не се затопля.	Вратата на фурната е затворена.
Фурната не се затопля.	Предпазителят не е изгорял.
Фурната не се затопля.	Защитата за деца е изключена.



Компоненти

Проблем	Проверете дали...
Лампичката е изключена.	Печене с влажност - е включена.
Лампичката не работи.	Лампичката е изгоряла.



Кодове за грешка

На дисплея се показва...	Проверете дали...
Err C3	Вратата на фурната е затворена или заключалката не е повредена.
Err F102	Вратата на фурната е затворена.
Err F102	Заключалката на вратата не е повредена.
00:00	Имаше прекъсване на захранването. Задайте час от денонощието.

Ако дисплеят показва код с грешка, който не е упоменат в настоящата таблица, изключете предпазителя и след това го включете наново, за да рестартирате фурната. Ако кодът с грешка се появи отново, обърнете се към оторизиран сервизен център.



Почистване

Проблем	Проверете дали...
Водата изтича от вътрешното отделение.	Има прекалено много вода във вътрешното отделение.

12.2 Данни за обслужване

Ако не можете да намерите решение на проблема сами, обърнете се към търговеца си или към упълномощен сервизен център.

Данните, необходими за сервизния център, са посочени на табелката с данни. Тази табелка се намира върху предната рамка на вътрешността на фурната. Не отстранявайте табелката с данни от вътрешността на фурната.

Препоръчваме ви да запишете данните тук:	
Модел (MOD.)
Номер на продукт (PNC)
Сериен номер (SN)

13. ЕНЕРГИЙНА ЕФЕКТИВНОСТ

13.1 Продуктова информация и Продуктов информационен лист*

Име на доставчик	AEG
Идентификация на модела	BPB351160M 944188506 BPS351160M 944188507
Индекс на енергийна ефективност	81.2
Клас на енергийна ефективност	A+
Консумация на енергия със стандартно натоварване, конвенционален режим	1.09 kWh/цикъл
Консумация на енергия със стандартно натоварване, засилен вентилационен режим	0.69 kWh/цикъл

Брой кухни	1	
Топлинен източник	Електричество	
Сила на звука	71 l	
Тип на фурната	Фурна за вграждане	
Маса	BPB351160M	34.0 kg
	BPS351160M	34.0 kg

*За Европейския съюз съгласно Регламенти (ЕС) 65/2014 и 66/2014.
За Република Беларус съгласно СТБ 2478 – 2017, Приложение G; СТБ 2477 – 2017, Анекси А и В.
За Украйна съгласно 568/32020.

Класът на енергийна ефективност не е приложим за Русия.

EN 60350-1 – Битови електрически уреди за готвене – Част 1: Гами, фурни, парни фурни и грилове – Методи за измерване на производителността.

13.2 Енергоспестяваща



Фурната съдържа функции, които ви позволяват да спестявате енергия при ежедневното готвене.

Уверете се, че вратата на фурната е затворена, когато фурната работи. Не отваряйте вратата на фурната твърде често по време на готвене. Поддържайте уплътнението на вратата чисто и се уверете, че е добре фиксирано в своята позиция. Използвайте метални готварски съдове, за да подобрите енергоспестяването. Когато е възможно, не загрявайте предварително фурната, преди готвене. Когато приготвяте няколко ястия наведнъж, свеждайте интервалите между готвенето им до минимум.

Готвене с вентилатор

При възможност използвайте функциите за готвене с вентилатор, за да пестите електроенергия.

Остатъчна топлина

Вентилаторът и лампичката продължават да работят. Когато изключите фурната, дисплеят показва остатъчната топлина. Можете да използвате тази топлина, за да държите храната топла.

Когато продължителността на готвене е по-голяма от 30 минути, намалете температурата на фурната до минимум 3 – 10 минути преди края на готвенето.

Остатъчната топлина вътре във фурната ще продължи да готви.

Използвайте остатъчната топлина, за да затопляте други храни.

Подгряване на храна

Изберете най-ниската възможна температурна настройка, за да използвате остатъчната топлина и да поддържате ястията топли. Индикаторът за остатъчна топлина или температура се появява на дисплея.

СТРУКТУРА НА МЕНЮТО

Готвене с изключена лампичка

Изключете лампичката по време на готвене. Включвайте я само, когато имате нужда от нея.



Печене с влажност

Функция, разработена за пестене на енергия по време на готвене.



Когато използвате тази функция, лампата автоматично се изключва след 30 секунди. Може да включите лампичката отново, но това действие ще намали очакваното енергоспестяване.

14. СТРУКТУРА НА МЕНЮТО

14.1 Меню

	 - изберете, за да влезете в Меню.
---	---

Меню структура

Помощ при готвене 	Почистване 	Настройки 
---	--	---



Стъпка 1	Стъпка 2	Стъпка 3	Стъпка 4	Стъпка 5
 	 OK	 O1 - O11	 OK	
Изберете Меню, Настройки.	Потвърдете настройката.	Изберете настройката.	Потвърдете настройката.	Настройте стойността и натиснете OK.

Настройки

O1	Час от денонощието	Промяна	O2	Яркост на екрана	1 - 5
O3	Звук на бутоните	1 - Бийп 2 - Щрак 3 - Изключен звук	O4	Сила на звук. сигнал	1 - 4
O5	Брояч	Вкл. / Изкл.	O6	Осветление	Вкл. / Изкл.

Настройки					
07	Бързо нагряване	Вкл. / Изкл.	08	Напомняне за почистване	Вкл. / Изкл.
09	Демо режим	Активиращ код: 2468	010	Софтуерна версия	Проверка
011	Зануляване на настройките	Да/Не			

15. ОПАЗВАНЕ НА ОКОЛНАТА СРЕДА

Рециклирайте материалите със символа . Поставете опаковките в съответните контейнери за рециклирането им. Помогнете за опазването на околната среда и човешкото здраве, както и за рециклирането на отпадъци от електрически и електронни уреди. Не изхвърляйте уредите, означени със символа , заедно с битовата смет. Върнете уреда в местния пункт за рециклиране или се обърнете към вашата общинска служба.

ZA SAVRŠENE REZULTATE

Hvala vam na odabiru ovog AEG proizvoda. Proizveli smo ga tako da dugo godina besprijekorno radi, primjenom inovativnih tehnologija koje olakšavaju život - funkcije koje možda nećete pronaći kod običnih uređaja. Odvojite nekoliko minuta na čitanje kako biste iz njega izvukli ono najbolje.

Posjetite naše internetske stranice:



Dobit ćete savjete o korištenju, rješavanju problema, brošure i informacije o servisu i popravcima:

www.aeg.com/support



Registrirajte svoj proizvod za bolju uslugu:

www.registreaeg.com



Kupite dodatnu opremu, potrošni materijal i originalne rezervne dijelove za svoj uređaj:

www.aeg.com/shop



Za više recepata, savjeta i rješavanje problema preuzmite aplikaciju **My AEG Kitchen**.





KORISNIČKA SLUŽBA I SERVIS

Uvijek koristite originalne zamjenske dijelove.

Kada kontaktirate naš ovlaštenu servis trebate imati sljedeće podatke: Model, PNC (part number code - bročana šifra dijela), serijski broj.

Podaci se mogu naći na nazivnoj pločici.

 Upozorenje / oprez - sigurnosne informacije

 Opće informacije i savjeti

 Ekološke informacije

Zadržava se pravo na izmjene.

SADRŽAJ

1. INFORMACIJE O SIGURNOSTI.....	77	3. OPIS PROIZVODA.....	83
1.1 Sigurnost djece i ranjivih osoba.....	77	3.1 Opći pregled.....	83
1.2 Opća sigurnost.....	78	3.2 Dodatna oprema.....	83
2. SIGURNOSNE UPUTE.....	79	4. KAKO UKLJUČITI I ISKLJUČITI	
2.1 Instalacija.....	79	PEČNICU.....	84
2.2 Električni priključak.....	80	4.1 Uvlačive tipke.....	84
2.3 Primjena.....	80	4.2 Upravljačka ploča.....	84
2.4 Održavanje i čišćenje.....	81	5. PRIJE PRVE UPORABE.....	85
2.5 Potrebno je čišćenje.....	82	5.1 Početno čišćenje.....	85
2.6 Unutarnje osvjetljenje.....	82	5.2 Početno predgrijavanje.....	86
2.7 Usluga.....	82		
2.8 Odlaganje.....	82		

6. SVAKODNEVNA UPORABA.....	86	11. ČIŠĆENJE I ODRŽAVANJE.....	101
6.1 Kako postaviti: Funkcije pećnice.....	86	11.1 Napomene o čišćenju.....	102
6.2 Funkcije pećnice.....	87	11.2 Kako očistiti: Udubljenje u unutrašnjosti.....	102
6.3 Napomene o: Vlažno pečenje.....	88	11.3 Kako ukloniti: Nosači police	102
6.4 Kako postaviti: Pomoć pri kuhanju.....	89	11.4 Način upotrebe: Pirolitičko čišćenje.....	103
6.5 Pomoć pri kuhanju s receptima.....	89	11.5 Podsjetnik Za Čišćenje.....	104
7. FUNKCIJE SATA.....	95	11.6 Kako ukloniti i postaviti: Vrata....	104
7.1 Funkcije sata.....	95	11.7 Kako zamijeniti: Žarulju.....	105
7.2 Kako postaviti: Funkcije sata.....	95	12. RJEŠAVANJE PROBLEMA.....	106
8. NAČIN KORIŠTENJA: PRIBOR.....	96	12.1 Što učiniti ako	106
8.1 Umetanje dodataka.....	97	12.2 Servisni podaci.....	107
9. DODATNE FUNKCIJE.....	97	13. ENERGETSKA UČINKOVITOST.....	108
9.1 Blokiranje.....	98	13.1 Podaci o proizvodu i List s podacima o proizvodu*.....	108
9.2 Automatsko isključivanje.....	98	13.2 Ušteda energije.....	109
9.3 Ventilator za hlađenje.....	98	14. STRUKTURA IZBORNIKA.....	109
10. SAVJETI.....	98	14.1 Izbornik.....	109
10.1 Vlažno pečenje.....	98		
10.2 Vlažno pečenje - preporučeni dodaci.....	99		
10.3 Tablice pečenja za ispitne ustanove.....	99		

1. INFORMACIJE O SIGURNOSTI

Prije postavljanja i korištenja uređaja, pažljivo pročitajte isporučene upute. Proizvođač nije odgovoran za bilo kakvu ozljedu ili oštećenje koji su rezultat neispravnog postavljanja ili korištenja. Upute uvijek držite na sigurnom i pristupačnom mjestu za buduću upotrebu.

1.1 Sigurnost djece i ranjivih osoba

- Ovaj uređaj mogu koristiti djeca u dobi od 8 godina i starija te osobe smanjenih tjelesnih, osjetilnih ili mentalnih mogućnosti ili osobe koje ne raspolažu iskustvom ili znanjem ako su pod nadzorom osobe odgovorne za njihovu sigurnost i rade po uputama koje se odnose na sigurno korištenje uređaja te razumiju uključene opasnosti. Djeca mlađa od 8 godina i osobe s vrlo teškim i složenim

invaliditetom moraju se držati podalje od uređaja, osim ako su pod stalnim nadzorom.

- Djeca bi trebala biti pod nadzorom kako bi se osiguralo da se ne igraju s uređajem.
- Ambalažu držite podalje od djece i zbrinite je na odgovarajući način.
- UPOZORENJE: Držite djecu i kućne ljubimce podalje od uređaja dok radi ili tijekom hlađenja. Dostupni dijelovi postaju vrući tijekom uporabe.
- Ako uređaj ima funkciju roditeljske zaštite, mora se aktivirati.
- Bez nadzora djeca ne smiju obavljati čišćenje uređaja i korisničko održavanje.

1.2 Opća sigurnost

- Samo kvalificirana osoba može postaviti ovaj uređaj i zamijeniti kabel.
- Ne upotrebljavajte uređaj prije postavljanja u ugradbeni ormarić.
- Isključite uređaj iz izvora napajanja prije obavljanja bilo kakvog održavanja.
- Ako je kabel napajanja oštećen, proizvođač, ovlaštenu servisnu centar ili slično kvalificirana osoba mora ga zamijeniti kako bi se izbjegla opasnost od strujnog udara.
- UPOZORENJE: Prije zamjene žarulje provjerite je li uređaj isključen kako biste izbjegli mogućnost strujnog udara.
- UPOZORENJE: Uređaj i njegovi dostupni dijelovi zagrijavaju se tijekom uporabe. Pazite da ne dodirujete grijače.
- Prilikom vađenja ili stavljanja pribora ili posuđa obavezno koristite rukavice.
- Za skidanje vodilica plitica najprije povucite prednji dio vodilice, a zatim stražnji dio dalje od bočnih stijenki. Vodilice polica vratite na mjesto obrnutim redoslijedom.
- Za čišćenje uređaja ne upotrebljavajte uređaje za parno čišćenje.

- Nemojte koristiti agresivna abrazivna sredstva za čišćenje ili oštre metalne strugače za čišćenje stakla na vratima pećnice jer mogu oštetiti površinu, a to može dovesti do loma stakla.
- Višak prolivenih tekućina mora se ukloniti prije pirolitičkog čišćenja. Izvadite sve dijelove iz pećnice.

2. SIGURNOSNE UPUTE

2.1 Instalacija



UPOZORENJE!

Samo kvalificirana osoba smije postaviti ovaj uređaj.

- Odstranite svu ambalažu.
- Ne postavljajte i ne koristite oštećeni uređaj.
- Slijedite upute za postavljanje isporučene s uređajem.
- Prilikom pomicanja uređaja uvijek budite pažljivi jer je uređaj težak. Uvijek nosite zaštitne rukavice i zatvorenu obuću.
- Uređaj ne povlačite za ručku.
- Ugradite uređaj na sigurno i prikladno mjesto koje udovoljava zahtjevima instalacije.
- Održavajte minimalnu udaljenost od drugih uređaja i kuhinjskih elemenata.
- Prije montaže uređaja provjerite otvaraju li se vrata pećnice bez ograničenja.
- Uređaj je opremljen električnim sustavom za hlađenje. Mora se priključiti na napajanje.
- Ugrađena jedinica mora udovoljavati zahtjevima stabilnosti prema normi DIN 68930.

Minimalna visina ormarića (minimalna visina ormarića ispod radne ploče)	578 (600) mm
Širina ormarića	560 mm
Dubina ormarića	550 (550) mm
Visina prednje strane uređaja	594 mm
Visina stražnje strane uređaja	576 mm
Širina prednje strane uređaja	595 mm
Širina stražnje strane uređaja	559 mm
Dubina uređaja	567 mm
Ugradna dubina uređaja	546 mm

Dubina s otvorenim vratima	1027 mm
Minimalna veličina ventilacijskog otvora. Otvor smješten na donjoj stražnjoj strani	560 x 20 mm
Dužina priključnog kabela. Kabel je smješten u desnom kutu stražnje strane	1500 mm
Vijci za montažu	4 x 25 mm

2.2 Električni priključak



UPOZORENJE!

Opasnost od požara i strujnog udara.

- Svako povezivanje s električnom mrežom treba izvršiti kvalificirani električar.
- Uređaj mora biti uzemljen.
- Provjerite jesu li parametri na natpisnoj pločici kompatibilni s električnim vrijednostima mrežnog napajanja.
- Uvijek koristite pravilno montiranu utičnicu sa zaštitom od strujnog udara.
- Ne koristite adaptere s više utičnica i produžne kabele.
- Pazite da ne oštetite utikač i kabel napajanja. Ako je potrebno zamijeniti električni kabel, to mora izvršiti ovlašteni servisni centar.
- Ne dopustite da kabel napajanja dodiruje ili dođe blizu vrata uređaja ili niši ispod uređaja, posebice kada radi ili su vrata vruća.
- Zaštita od strujnog udara dijelova pod naponom i izoliranih dijelova mora biti pričvršćena na takav način da se ne može ukloniti bez alata.
- Utikač kabela napajanja uključite u utičnicu tek po završetku postavljanja. Provjerite postoji li nakon montaže pristup utikaču.
- Ako je utičnica labava, nemojte priključivati utikač.
- Ne povlačite kabel napajanja kako biste izvukli utikač iz utičnice. Uvijek uhvatite i povucite utikač.
- Koristite samo odgovarajuće izolacijske uređaje: automatske sklopke, osigurače (osigurače na uvrtnje izvaditi iz ležišta), sklopke i releje zemnog spoja.
- Električna instalacija mora imati izolacijski uređaj koji vam omogućuje isključivanje uređaja iz električne mreže na svim polovima. Izolacijski uređaj mora imati kontakte s otvorom minimalne širine 3 mm.
- Vrata uređaja do kraja zatvorite prije priključivanja utikača u utičnicu napajanja.
- Ovaj uređaj se isporučuje s glavnim utikačem i glavnim kabelom.

2.3 Primjena



UPOZORENJE!

Opasnost od ozljede, opekline, strujnog udara ili eksplozije.

- Ovaj uređaj namijenjen je isključivo uporabi u kućanstvu (u zatvorenom).
- Ne mijenjajte specifikacije ovog uređaja.
- Pazite da se ventilacijski otvori nisu blokirani.

- Ne ostavljajte uređaj bez nadzora tijekom rada.
- Isključite uređaj nakon svake uporabe.
- Budite oprezni prilikom otvaranja vrata dok uređaj radi. Može se osloboditi vrući zrak.
- Ne rukujte uređajem mokrim rukama ili ako ima kontakt s vodom.
- Ne pritiskajte otvorena vrata.
- Ne koristite uređaj kao radnu površinu ili kao površinu za odlaganje.
- Pažljivo otvorite vrata uređaja. Korištenje sastojaka s alkoholom može uzrokovati mješavinu alkohola i zraka.
- Kad otvarate vrata, ne dopustite da iskre ili otvoreni plamen dođu u kontakt s uređajem.
- Ne stavljajte zapaljive proizvode ili mokre predmete sa zapaljivim proizvodima u uređaj, blizu uređaja ili na uređaj.



UPOZORENJE!

Postoji opasnost od oštećenja uređaja.

- Da biste spriječili oštećenje ili promjenu boje emajla:
 - ne stavljajte posuđe ili druge predmete izravno na dno uređaja.
 - ne stavljajte aluminijsku foliju izravno na dno unutrašnjosti uređaja.
 - ne stavljajte vodu izravno u vrući uređaj.
 - ne držite vlažno posuđe i hranu u uređaju nakon završetka kuhanja.
 - budite oprezni prilikom uklanjanja ili instaliranja dodatne opreme.
- Gubitak boje emajla ili nehrđajućeg čelika nema utjecaj na performanse uređaja.
- Koristite duboku pliticu za vlažne kolače. Voćni sokovi uzrokuju mrlje koje mogu biti trajne.
- Ovaj uređaj namijenjen je isključivo za kuhanje. Ne smije se koristiti u druge svrhe, na primjer za grijanje prostorije.
- Uvijek kuhajte s zatvorenim vratima pećnice.
- Ako je uređaj postavljen iza neke ploče (npr. vrata) osigurajte da vrata nikad nisu zatvorena dok uređaj radi. Toplina i vlaga mogu se nakupiti iza takve ploče i uzrokovati naknadna oštećenja uređaja, kućišta ili poda. Ne zatvarajte ploču dok se uređaj potpuno ne ohladi nakon uporabe.

2.4 Održavanje i čišćenje



UPOZORENJE!

Postoji opasnost od ozljede, vatre ili oštećenja uređaja.

- Prije održavanja uređaj isključite a utikač izvucite iz utičnice mrežnog napajanja.
- Provjerite je li uređaj hladan. Postoji opasnost od puknuća staklenih ploča.
- Staklene ploče vrata odmah zamijenite kada su oštećene. Obratite se ovlaštenom servisnom centru.
- Pazite pri uklanjanju vrata s uređaja. Vrata su teška!
- Uređaj redovito očistite kako biste spriječili propadanje materijala površine.
- Uređaj očistite vlažnom mekom krpom. Koristite samo neutralne deterdžente. Nikada ne koristite abrazivna sredstva, abrazivne spužvice za ribanje, otapala ili metalne predmete.
- Ako koristite raspršivač za čišćenje pećnice, slijedite sigurnosne upute na ambalaži.

2.5 Potrebno je čišćenje



UPOZORENJE!

Opasnost od ozljeda/ požara/ kemijskog isparavanja (dim) u pirolitičkom načinu rada.

- Prije uključenja funkcije Pirolitičko samočišćenje ili Prva Uporaba, iz unutrašnjosti pećnice izvadite:
 - sve prekomjerne ostatke hrane, ostatke/naslage ulja ili masti.
 - sve uklonjive predmete (uključujući police, bočne vodilice itd. isporučene s uređajem) te posebno sve neprijanjajuće posude, plitice, pladnjeve, pribor itd.
- Pažljivo pročitajte sve upute za pirolitičko čišćenje.
- Zadržite djecu daleko od uređaja dok pirolitičko čišćenje djeluje. Uređaj postane vruć, a kroz prednje ventilacijske otvore izlazi vrući zrak.
- Pirolitičko čišćenje je operacija s visokom temperaturom koja može uzrokovati otpuštanje dima od ostataka jela i konstrukcijskih materijala, te se strogo preporučuje:
 - omogućiti dobru ventilaciju tijekom i nakon svakog pirolitičkog čišćenja.
 - omogućiti dobru ventilaciju tijekom i nakon prve upotrebe na maksimalnoj temperaturi.
- Za razliku od ljudi, neke ptice i gmazovi mogu biti iznimno osjetljivi na moguće dimove koji se javljaju tijekom postupka čišćenja svih pirolitičkih pećnica.
 - Kućni ljubimci (osobito ptice) ne smiju biti u blizini pećnice tijekom i nakon pirolitičkog čišćenje i prvog korištenja na maksimalnoj temperaturi u dobro prozračenom području.
- Mali kućni ljubimci također mogu biti vrlo osjetljivi na lokalne promjene u temperaturi u blizini pirolitičkih pećnica kada je program pirolitičkog samočišćenja u radu.
- Neprijanjajuće površine na posudama, tavama, pliticama, priboru, itd., može oštetiti visoka temperatura pirolitičkog čišćenja u pirolitičkim pećnicama, a može biti i izvor štetnih plinova niske razine.
- Opisani dimovi koji se ispuštaju iz pirolitičkih pećnica / od ostataka kuhanja nisu štetni za ljude djecu, ili osobe s kroničnim oboljenjima.

2.6 Unutarnje osvjetljenje



UPOZORENJE!

Opasnost od električnog udara.

- Što se tiče žarulje(a) unutar ovog proizvoda i rezervnih žarulja koje se prodaju zasebno: Ove žarulje namijenjene su da izdrže ekstremne fizičke uvjete u kućanskim uređajima, poput temperature, vibracija, vlage ili namijenjene su signalizaciji informacija o radnom stanju uređaja. Nisu namijenjene za druge primjene i nisu pogodne za osvjetljenje u kućanstvu.
- Koristite samo žarulje s istim specifikacijama.

2.7 Usluga

- Za popravak uređaja kontaktirajte ovlaštenu servis.
- Koristite samo originalne rezervne dijelove.

2.8 Odlaganje



UPOZORENJE!

Opasnost od ozljede ili gušenja.

- Iskopčajte uređaj iz napajanja.
- Odrežite kabel napajanja blizu uređaja i odložite ga.

- Uklonite bravu na vratima kako biste spriječili zatvaranje djece ili kućnih ljubimaca u uređaju.

3. OPIS PROIZVODA

3.1 Opći pregled

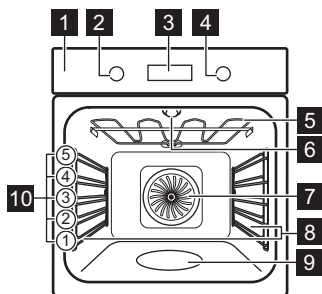

- 1** Upravljačka ploča
- 2** Regulator funkcija pećnice
- 3** Zaslon
- 4** Upravljački okretni gumb
- 5** Toplinski element
- 6** Žarulja
- 7** Ventilator
- 8** Nosač polica, uklonjiv
- 9** Položaji polica
- 10** Udubljenje u unutrašnjosti

3.2 Dodatna oprema

Mreža za pečenje

Za posuđe, kalupe za torte, pečenje.

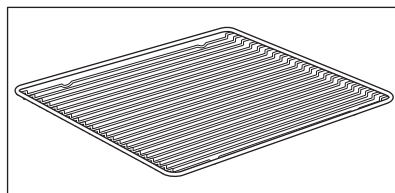

Pekač za pecivo

Za torte i biskvite.

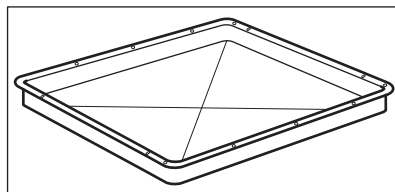

KAKO UKLJUČITI I ISKLJUČITI PEĆNICU

Duboka plitica za roštilj/prženje

Za prženje i pečenje ili kao tava za skupljanje masnoće.

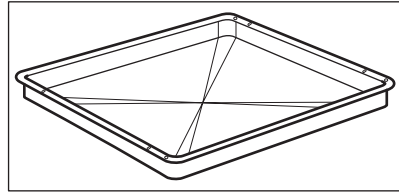

Teleskopske vodilice

Za lakše umetanje i uklanjanje plitica i mreže za pečenje.

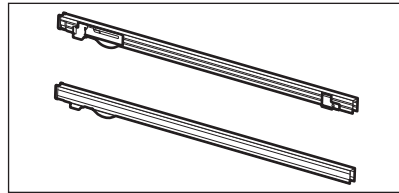







4. KAKO UKLJUČITI I ISKLJUČITI PEĆNICU

4.1 Uvlačive tipke

Za početak korištenja uređaja pritisnite tipku. Tipka se izvlači.

4.2 Upravljačka ploča

Polja senzora na upravljačkoj ploči					Pritisnite	Okrenite regulator
 Tajmer	 Brzo zagrijavanje	 Osvjetljenje unutrašnjosti	 Blokiranje	OK		
Odaberite funkciju pećnice i uključite pećnicu.						
Okrenite regulator funkcija pećnice u isključeni položaj i isključite pećnicu.						

	Kad je regulator za funkcije pećnice u položaju isključeno, zaslon prelazi u stanje pripravnosti.
---	---

PRIJE PRVE UPORABE

	<p>Kad kuhate, na zaslonu se prikazuje podešena temperatura, sat i ostale dostupne opcije.</p>
	<p>Zaslon s maksimalnim brojem postavljenih funkcija.</p>

Indikatori zaslona				
<p>Blokiranje</p>	<p>Pomoć pri kuhanju</p>	<p>Čišćenje</p>	<p>Postavke</p>	<p>Brzo zagrijavanje</p>
<p>Pokazatelji tajmera:</p>				
<p>Traka napretka - za temperaturu ili vrijeme.</p>				
<p>Pokazatelj kuhanja na pari</p>				

5. PRIJE PRVE UPORABE

	<p>UPOZORENJE! Pogledajte poglavlja sa sigurnosnim uputama.</p>
--	--

5.1 Početno čišćenje

Prije prve uporabe obavite čišćenje prazne pećnice i podesite vrijeme:			
			<p>00:00 Postavite vrijeme. Pritisnite OK.</p>

svakodnevna uporaba

5.2 Početno predgrijavanje



Prije prve uporabe unaprijed zagrijte praznu pećnicu.

1. korak Izvadite sav pribor i sve uklonjive nosače polica iz pećnice.

2. korak Postavite maksimalnu temperaturu za funkciju: 
Pustite pećnicu da radi 1 sat.

3. korak Postavite maksimalnu temperaturu za funkciju: 
Pustite pećnicu da radi 15 minuta.

 Tijekom predgrijavanja pećnica može stvarati neugodan miris i dim. Obavezno provjerite da se prostorija prozračuje.

6. SVAKODNEVNA UPORABA



UPOZORENJE!

Pogledajte poglavlja sa sigurnosnim uputama.

6.1 Kako postaviti: Funkcije pećnice

Početak kuhanja

1. korak



Postavite funkciju zagrijavanja.

Korak 2



Postavite temperaturu.

Kuhanje na pari



Provjerite je li pećnica hladna.

Korak 1

2. korak

3. korak



4. korak









Kuhanje na pari			
			Prethodno zagrijte praznu pećnicu 10 min kako bi se stvorila vlaga. Stavite hranu u pećnicu.
Udubinu u unutrašnjosti pećnice napunite vodom iz slavine.	Podesite paru funkciju pećnice.	Postavite temperaturu.	
<p>i Maksimalni kapacitet udubine u unutrašnjosti iznosi 250 ml. Tijekom kuhanja ili dok je pećnica još vruća ne nadopunjavajte udubinu u unutrašnjosti.</p>			

Kada se završi kuhanje na pari:		
Korak 1	2. korak	Korak 3
Okrenite okretni gumb za funkcije pećnice u položaj isključeno za isključivanje pećnice.	Pažljivo otvorite vrata. Ispuštena vlaga može izazvati opekline.	Provjerite je li pećnica hladna. Iz udubine u unutrašnjosti uklonite preostalu vodu.

6.2 Funkcije pećnice

Standardne funkcije pećnice

Funkcija pećnice	Aplikacija
 Vrući zrak	Za pečenje na do tri razine polica istovremeno i za sušenje hrane. Podesite temperaturu 20 - 40 °C niže nego za Tradicionalno pečenje.
 Tradicionalno pečenje	Za pečenje i prženje hrane na jednoj razini police.

Funkcija pećnice	Aplikacija
 <p>SteamBake</p>	Za dodavanje vlažnosti tijekom kuhanja. Da biste dobili pravu boju i hrskavu koru tijekom pečenja. Za više sočnosti tijekom podgrijavanja. Za konzerviranje voća i povrća.
 <p>Funkcija za pizzu</p>	Za pečenje pizze. Za intenzivno tamnjenje i hrskavo dno.
 <p>Donji grijač</p>	Za pečenje kolača s hrskavim dnom i konzerviranje hrane.
 <p>Zamrznuta hrana</p>	Za pripremu hrskavih gotovih jela (npr. pomfrita, kroketa od krumpira ili proljetnih rolada).
 <p>Vlažno pečenje</p>	Ova funkcija napravljena je za uštedu energije tijekom kuhanja. Kad koristite ovu funkciju, temperatura u unutrašnjosti može se razlikovati od postavljene temperature. Koristi se preostala toplina. Snaga zagrijavanja može se smanjiti. Za više informacija pogledajte poglavlje "Svakodnevna uporaba", napomene o: Vlažno pečenje.
 <p>Roštilj</p>	Za roštiljanje tankih komada hrane i pripremu tostiranog kruha.
 <p>Turbo roštilj</p>	Za pečenje velikih komada mesa ili peradi s kostima na jednom položaju police. Za pripremu zapečenih jela i tamnjenje.
 <p>Izbornik</p>	Za ulazak u izbornik: Pomoć pri kuhanju, Čišćenje, Postavke.

6.3 Napomene o: Vlažno pečenje





Ova funkcija korištena je za usklađivanje s razredom energetske učinkovitosti i zahtjevima ekološkog dizajna u skladu s EU 65/2014 i EU 66/2014. Ispitivanja u skladu s EN 60350-1. Vrata pećnice moraju biti zatvorena tijekom pečenja tako da se funkcija ne ometa i da pećnica radi s najvišom mogućom energetskom učinkovitošću.

Kad koristite ovu funkciju, svjetlo se automatski isključuje nakon 30 s.



Upute za kuhanje potražite u poglavlju "Savjeti i preporuke", Vlažno pečenje. Opće preporuke za uštedu energije potražite u poglavlju "Energetske učinkovitost", Ušteda energije.

6.4 Kako postaviti: Pomoć pri kuhanju

Svako jelo u ovom podizborniku ima preporučenu funkciju i temperaturu. Možete podesiti vrijeme i temperaturu tijekom kuhanja.

Pomoć pri kuhanju - upotrijebite za brzu pripremu jela sa zadanim postavkama:			
Korak 1	2. korak	3. korak	4. korak
			
Uđite u izbornik.	Odaberite Pomoć pri kuhanju. Pritisnite OK.	Odaberite jelo. Pritisnite OK.	Stavite jelo u pećnicu. Potvrdite postavku.





6.5 Pomoć pri kuhanju s receptima

Legenda	
	Količina vode za parnu funkciju.
	Prethodno zagrijte pećnicu prije početka kuhanja.
	Razina police.









Kad funkcija završi, provjerite je li hrana spremna.

	Jelo	Težina	Razina police / dodatna oprema	Vrijeme trajanja
Govedina 				













svakodnevna uporaba

	Jelo	Težina	Razina police / dodatna oprema	Vrijeme trajanja
P1	Goveđe pečenje, slabo pečeno	1 - 1,5 kg; 4 - 5 cm, debeli komadi	 2; pekač za pecivo Meso pržite nekoliko minuta na vrućoj tavi. Stavite u pećnicu.	40 min
P2	Goveđe pečenje, srednje pečeno			50 min
P3	Goveđe pečenje, dobro pečeno			60 min
P4	Odrezak, srednje pečen	180 - 220 g po komadu; kriške debele 3 cm	  3; jelo pečeno na mreži za pečenje Meso pržite nekoliko minuta na vrućoj tavi. Stavite u pećnicu.	15 min
P5	Goveđe pečenje / pirjano (glavno rebro, gornji okrugli odrezak, debeli but)	1,5 - 2 kg	 2; jelo pečeno na mreži za pečenje Meso pržite nekoliko minuta na vrućoj tavi. Dodajte tekućinu. Stavite u pećnicu.	120 min
P6	Goveđe pečenje, slabo pečeno (sporo pečenje)	1 - 1,5 kg; 4 - 5 cm, debeli komadi	 2; pekač za pecivo Koristite svoje omiljene začine ili jednostavno samo sol i svježe mljeveni papar. Meso pržite nekoliko minuta na vrućoj tavi. Stavite u pećnicu.	75 min
P7	Goveđe pečenje, srednje pečeno (sporo pečenje)			85 min
P8	Goveđe pečenje, dobro pečeno (sporo pečenje)			130 min























SVAKODNEVNA UPORABA

	Jelo	Težina	Razina police / dodatna oprema	Vrijeme trajanja
P9	Filet, slabo pečen (sporo pečenje)	0,5 - 1,5 kg; 5 - 6 cm debeli komadi	 2; pekač za pecivo Koristite svoje omiljene začine ili jednostavno samo sol i svježe mljeveni papar. Meso pržite nekoliko minuta na vrućoj tavi. Stavite u pećnicu.	75 min
P10	Filet, srednje pečen (sporo pečenje)			90 min
P11	Filet, pečen (sporo pečenje)			120 min
Teletina 				
P12	Teleće pečenje (npr. plećka)	0,8 - 1,5 kg; 4 cm debeli komadi	 2; jelo pečeno na mreži za pečenje Koristite svoje omiljene začine. Dodajte tekućinu. Pečenje pokriveno.	80 min
Svinjetina 				
P13	Pečena svinjetina, vrat ili plećka	1,5 - 2 kg	 2; jelo pečeno na mreži za pečenje Meso okrenite nakon polovice vremena kuhanja.	120 min
P14	Trgana svinjetina LTC	1,5 - 2 kg	 2; pekač za pecivo Koristite svoje omiljene začine. Meso okrenite nakon polovice vremena kuhanja da se ujednačeno zapeče.	215 min
P15	Pečenica, svježa	1 - 1,5 kg; 5 - 6 cm debeli komadi	 2; jelo pečeno na mreži za pečenje Koristite svoje omiljene začine.	55 min
P16	Svinjska rebrica	2 - 3 kg; upotrijebite sirove, 2 - 3 cm tanke svinjske rebrice	 3; duboka tava Dodajte tekućinu tako da pokrije dno posude. Meso okrenite nakon polovice vremena kuhanja.	90 min
Janjetina 				



















svakodnevna uporaba



	Jelo	Težina	Razina police / dodatna oprema	Vrijeme trajanja
P17	Janjeći but s kosti	1,5 - 2 kg; 7 - 9 cm debeli komadi	 2; jelo pečeno na pekaču za pecivo . Dodajte tekućinu. Meso okrenite nakon polovice vremena kuhanja.	130 min
Perad 				
P18	Cijelo pile	1 - 1,5 kg; svježe	 2;  200 ml; složenac na pekaču za pecivo . Koristite svoje omiljene začine. Piletinu okrenite nakon polovice vremena kuhanja da se ujednačeno zapeče.	60 min
P19	Polovica pileta	0,5 - 0,8 kg	 3 ; pekač za pecivo . Koristite svoje omiljene začine.	40 min
P20	Pileća prsa	180 - 200 g po komadu	  2; složenac na mreži za pečenje . Koristite svoje omiljene začine. Meso pržite nekoliko minuta na vrućoj tavi.	25 min
P21	Pileći batak, svježi	-	 3; pekač za pecivo . Ako ste pileće batak prvo marinirali, podesite nižu temperaturu i kuhajte ih duže.	30 min
P22	Patka, cijela	2 - 3 kg	 2; jelo pečeno na mreži za pečenje . Koristite svoje omiljene začine. Stavite meso na posudu za pečenje. Patku okrenite nakon polovice vremena kuhanja.	100 min
P23	Guska, cijela	4 - 5 kg	 2; duboka tava . Koristite svoje omiljene začine. Stavite meso na duboki pekač za pecivo. Gusku okrenite nakon polovice vremena kuhanja.	110 min
Ostalo 				
P24	Mesna štruca	1 kg	 2; mreža za pečenje . Koristite svoje omiljene začine.	60 min

SVAKODNEVNA UPORABA

	Jelo	Težina	Razina police / dodatna oprema	Vrijeme trajanja
 Riba				
P25	Cijela riba, na roštilju	0,5 - 1 kg po ribi	 2 ; pekač za pecivo Ribu napunite maslacem i upotrijebite svoje omiljene začine i začinsko bilje.	30 min
P26	Riblji filet	-	  3; složenac na mreži za pečenje Koristite svoje omiljene začine.	20 min
slatko pecivo / deserti   				
P27	Torta od sira	-	 2;  28 cm kalup za kore na mreži za pečenje	90 min
P28	Torta od jabuka	-	 2;  100 - 150 ml; pekač za pecivo	60 min
P29	Tart od jabuka	-	 2; kalup za pitu na mreži za pečenje	40 min
P30	Pita od jabuka	-	 2;  100 - 150 ml;  22 cm kalup za pitu na mreži za pečenje	60 min
P31	Čokoladni kolačići (tzv. brownies)	2 kg	 3; duboka tava	30 min
P32	Čokoladni muffini	-	 2;  100 - 150 ml; pekač za muffine na mreži za pečenje	30 min
P33	Kolač štruca	-	 2; kalup za štruca na mreži za pečenje	50 min
Povrće / prilozi   				
P34	Pečeni krumpiri	1 kg	 2; pekač za pecivo Stavite cijele krumpire s korom na pekač za pecivo.	50 min





svakodnevna uporaba

	Jelo	Težina	Razina police / dodatna oprema	Vrijeme trajanja
P35	Kroketi	1 kg	 3; pekač za pecivo obložen papirom za pečenje Koristite svoje omiljene začine. Krumpir rezani na komadiće.	35 min
P36	Grilovano miješano povrće	1 - 1,5 kg	 3; pekač za pecivo obložen papirom za pečenje Koristite svoje omiljene začine. Narežite povrće na komadiće.	30 min
P37	Kroketi, smrznuti	0,5 kg	 3; pekač za pecivo	25 min
P38	Pommes, smrznuti	0,75 kg	 3; pekač za pecivo	25 min
Gratini, kruh i pizza   				
P39	Složenac lasagna / rezanci	1 - 1,5 kg	 2; složenac na mreži za pečenje	45 min
P40	Zapečeni krumpir	1 - 1,5 kg	 1; složenac na mreži za pečenje	50 min
P41	Pizza svježa, tanka	-	  2;  100 ml; pekač za pecivo obložen papirom za pečenje	15 min
P42	Pizza svježa, debela	-	  2;  100 ml; pekač za pecivo obložen papirom za pečenje	25 min
P43	Quiche	-	 2; kalup za pečenje na mreži za pečenje	45 min
P44	Baguette / ciabatta / bijeli kruh	0,8 kg	  3;  150 ml; pekač za pecivo obložen papirom za pečenje Potrebno je više vremena za bijeli kruh.	30 min

	Jelo	Težina	Razina police / dodatna oprema	Vrijeme trajanja
P45	Sve žitarice / raž / crni kruh sve žitarice u kalupu za kruh	1 kg	  2;  150 ml; pekač za pecivo obložen papirom za pečenje / mrežom za pečenje	45 min

7. FUNKCIJE SATA

7.1 Funkcije sata





Funkcija sata	Aplikacija
	Zvučni alarm. Po isteku tajmera oglašava se zvučni signal.
	Vrijeme kuhanja. Po isteku tajmera oglašava se zvučni signal i funkcija pećnice se zaustavlja.
	Vrijeme odgode. Za odgodu početka i / ili na kraju kuhanja.
	Tajmer prema gore. Maksimalno je 23 h 59 min. Ova funkcija ne utječe na rad pećnice. Za uključivanje i isključivanje Tajmer prema gore odaberite: Izbornik, Postavke.

7.2 Kako postaviti: Funkcije sata

Kako podesiti: Sat		
Korak 1	2. korak	Korak 3
		
Za promjenu sata, uđite u izbornik i odaberite postavke, sat.	Postavite sat.	Pritisnite: OK.







NAČIN KORIŠTENJA: PRIBOR

Kako podesiti: Zvučni alarm

1. korak	Na zaslonu se prikazuje: 0:00 	2. korak	Korak 3
			
Pritisnite: 		Postavite Zvučni alarm	Pritisnite: OK.









 Tajmer odmah počinje s odbrojavanjem.

Kako podesiti: Vrijeme kuhanja

Korak 1	Korak 2	Na zaslonu se prikazuje: 0:00  STOP	3. korak	4. korak
				
Odaberite funkciju pećnice i postavite temperaturu.	Pritisnite nekoliko puta: 		Postavite vrijeme kuhanja.	Pritisnite: OK.

 Tajmer odmah počinje s odbrojavanjem.

Kako podesiti: Vrijeme odgode

Korak 1	Korak 2	Na zaslonu se prikazuje: sat  POČETAK	3. korak	4. korak	Na zaslonu se prikazuje: --:--  ZAUŠTAVI	5. korak	6. korak
							
Odaberite funkciju pećnice.	Pritisnite nekoliko puta: 		Postavite vrijeme početka.	Pritisnite: OK.		Postavite vrijeme završetka.	Pritisnite: OK.

 Tajmer počinje odbrojavanje u podešeno vrijeme početka.

8. NAČIN KORIŠTENJA: PRIBOR

8.1 Umetanje dodataka

Mala udubljenja na vrhu povećavaju sigurnost. Te udubine ujedno su i dodatna mjera protiv prevrtanja. Visoki obod oko police sprječava klizanje posuđa s police.

Mreža za pečenje:

Gurnite mrežu između vodilica nosača police .

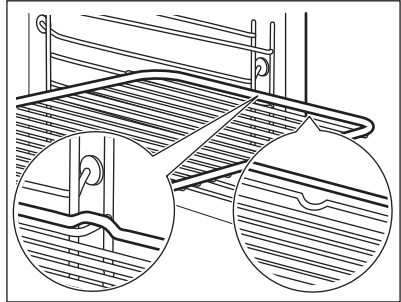
**Pekač za pecivo /Duboka plitica:**

Gurnite pladanj za pečenje između vodilica police.

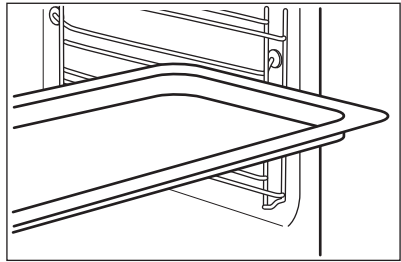
**Mreža za pečenje, Pekač za pecivo /Duboka plitica:**

Gurnite pekač za pecivo između vodilica na nosaču police i mreže za pečenje na vodilicama iznad.

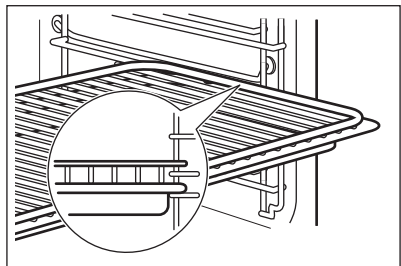

9. DODATNE FUNKCIJE

9.1 Blokiranje

Ova funkcija sprječava nehotičnu promjenu funkcije pećnice.

Uključite je kad pećnica radi - podešeno kuhanje se nastavlja, upravljačka ploča je blokirana.
Uključite je kad je pećnica isključena - pećnica se ne može uključiti, upravljačka ploča je blokirana.





 - pritisnite i držite za uključivanje funkcije.
Čuje se zvučni signal.

 - pritisnite i držite za isključivanje.

 3 x  - bljeska kad je blokiranje uključeno.

9.2 Automatsko isključivanje

Iz sigurnosnih razloga pećnica se isključuje nakon nekog vremena, ako funkcija pećnice radi a vi ne promijenite niti jednu postavku.

 (°C)	 (h)
30 - 115	12.5
120 - 195	8.5
200 - 245	5.5
250 - maksimum	3

Automatsko isključivanje ne radi s funkcijama: Osvijetljenje unutrašnjosti, Vrijeme odgode.



9.3 Ventilator za hlađenje

Kad pećnica radi, ventilator za hlađenje automatski se uključuje da ohladi površine pećnice.
Ako isključite pećnicu, ventilator za hlađenje može nastaviti s radom dok se pećnica ne ohladi.

10. SAVJETI

10.1 Vlažno pečenje

Za najbolje rezultate slijedite preporuke navedene u tablici ispod.
Koristite treći položaj police u pećnici.

	 (°C)	 (min)
Zapečena tjestenina	200 - 220	45 - 55
Zapečeni krumpir	180 - 200	70 - 85
Musaka	170 - 190	70 - 95
Lasagne	180 - 200	75 - 90
Caneloni	180 - 200	70 - 85
Puding od kruha	190 - 200	55 - 70
Puding od riže	170 - 190	45 - 60
Torta od jabuka, od miješanog biskvita (okrugli kalup za kolače)	160 - 170	70 - 80
Bijeli kruh	190 - 200	55 - 70

10.2 Vlažno pečenje - preporučeni dodaci

Koristite tamne i nereflektirajuće posude i spremnike. Imaju bolju apsorpciju topline od svjetle boje i reflektirajućeg posuđa.

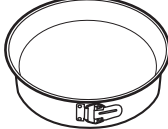
			
Tava za pizzu	Posuda za pečenje	Ramekin posude	Kalup za flan
Tamni, nereflektirajući Promjer 28 cm	Tamni, nereflektirajući Promjer 26 cm	Keramika Promjer 8 cm, visina 5 cm	Tamni, nereflektirajući Promjer 28 cm





10.3 Tablice pečenja za ispitne ustanove

Informacije za ustanove za testiranje

Testovi prema: EN 60350, IEC 60350.



PEČENJE NA JEDNOJ RAZINI. Pečenje u kalupima





		 (°C)	 (min)	
Bezmasni biskvit	Vrući zrak	140 - 150	35 - 50	2
Bezmasni biskvit	Tradicionalno pečenje	160	35 - 50	2
Pita od jabuka, 2 kalupa Ø20 cm	Vrući zrak	160	60 - 90	2
Pita od jabuka, 2 kalupa Ø20 cm	Tradicionalno pečenje	180	70 - 90	1



PEČENJE NA JEDNOJ RAZINI. Keksi







Koristite treći položaj police u pećnici.

		 (°C)	 (min)
Prhko tijesto / Prutići od tijesta	Vrući zrak	140	25 - 40
Prhko tijesto / Prutići od tijesta, prethodno zagrijte praznu pećnicu	Tradicionalno pečenje	160	20 - 30
Mali kolači, 20 po plitici, prethodno zagrijte praznu pećnicu	Vrući zrak	150	20 - 35
Mali kolači, 20 po plitici, prethodno zagrijte praznu pećnicu	Tradicionalno pečenje	170	20 - 30



PEČENJE NA VIŠE RAZINA. Keksi

		 (°C)	 (min)	
Prhko tijesto / Prutići od tijesta	Vrući zrak	140	25 - 45	1 / 4
Mali kolači, 20 po plitici, prethodno zagrijte praznu pećnicu	Vrući zrak	150	23 - 40	1 / 4
Bezmasni biskvit	Vrući zrak	160	35 - 50	1 / 4







ROŠTILJ



Praznu pećnicu prethodno zagrijte 5 minuta.



Roštilj na maksimalnoj postavci temperature.

		 (min)	
Tost	Roštilj	1 - 3	5
Goveđi odrezak, okrenite na drugu stranu nakon protoka polovice vremena	Roštilj	24 - 30	4



11. ČIŠĆENJE I ODRŽAVANJE



UPOZORENJE!

Pogledajte poglavlja sa sigurnosnim uputama.

11.1 Napomene o čišćenju

 Sredstva za čišćenje	Prednju stranu pećnice očistite mekom krpom namočenom u mlaku vodu i blagim deterdžentom.
	Za čišćenje metalnih površina koristite otopinu za čišćenje.
	Mrlje očistite blagim deterdžentom.
 Svakodnevna uporaba	Unutrašnjost pećnice očistite nakon svake uporabe. Nakupljanje masti ili drugih ostataka može uzrokovati požar.
	Ne čuvajte hranu u pećnici dulje od 20 minuta. Nakon svake uporabe osušite unutrašnjost mekanom krpom.
 Dodatna oprema	Nakon svake upotrebe očistite svu dodatnu opremu i pustite da se osuši. Koristite meku krpu namočenu u toplu vodu i blagi deterdžent. Pribor ne perite u perilici posuđa.
	Ne čistite pribor s neprijanjajućim površinama pomoću abrazivnih sredstava za čišćenje ili predmeta s oštrim rubovima.

11.2 Kako očistiti: Udubljenje u unutrašnjosti

Očistite udubljenje u unutrašnjosti kako biste uklonili ostatke kamenca nakon kuhanja s parom.

Korak 1	2. korak	Korak 3
Ulijte: 250 ml alkoholnog octa u udubljenje u unutrašnjosti. Koristite najviše 6%-ni ocat bez ikakvih dodataka.	Ostavite ocat 30 minuta na sobnoj temperaturi da otopi naslage kamenca.	Unutrašnjost očistite toplom vodom i mekanom krpom.
Za funkciju: SteamBake očistite pećnicu svakih 5 - 10 ciklusa kuhanja.		

11.3 Kako ukloniti: Nosači police

Kako biste očistili pećnicu, skinite nosače police.

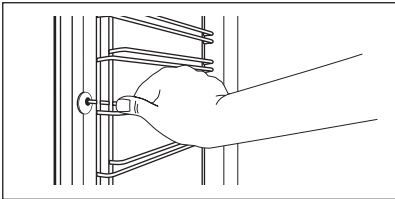
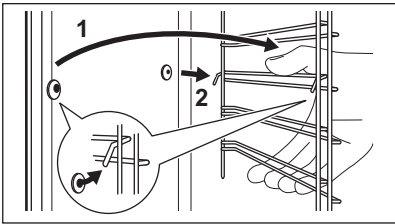
1. korak	Isključite pećnicu i pričekajte da se ohladi.	
2. korak	Prednji dio nosača police povucite dalje od bočne stijenke.	
3. korak	Stražnji dio nosača police povucite s bočne stijenke i uklonite ga.	
4. korak	Nosače police vratite na mjesto obrnutim redosljedom. Zatike za držanje na sklopivim vodilicama morate usmjeriti prema naprijed.	

11.4 Način upotrebe: Pirolitičko čišćenje

Očistite pećnicu opcije Pirolitičko čišćenje.



UPOZORENJE!

Postoji rizik od opekline.



OPREZ!

Ako su u isti ormarić postavljeni drugi uređaji, ne upotrebljavajte ih istodobno s ovom funkcijom. To može uzrokovati oštećenje pećnice.

Prije Pirolitičko čišćenje:

Isključite pećnicu i pričekajte da se ohladi.	Izvadite sav pribor iz pećnice i uklonjive nosače polica.	Očistite dno pećnice i unutrašnje staklo vrata toplom vodom, mekom krpom i blagim deterdžentom.
---	---	---

Pirolitičko čišćenje

1. korak	Uđite u izbornik: Čišćenje $\frac{m}{l}$.	
	Opcija	Trajanje
	C1 - Lagano čišćenje	1 h
	C2 - Normalno čišćenje	1 h 30 min

ČIŠĆENJE I ODRŽAVANJE

Pirolitičko čišćenje

C3 - Temeljito čišćenje

3 h

2. korak

OK – pritisnite za odabir programa za čišćenje.

3. korak

OK – pritisnite za početak čišćenja.

4. korak

Nakon čišćenja regulator funkcija pećnice okrenite u položaj isključeno.

 Tijekom čišćenja svjetlo pećnice je isključeno.

Kada je pećnica na postavljenoj temperaturi, vrata se zaključavaju. Dok se vrata ne otključaju, na zaslonu se prikazuje: .

Kada čišćenje završi:

Isključite pećnicu i pričeka-
kajte da se ohladi.

Unutrašnjost očistite mekanom
krpom.

S dna unutrašnjosti uklonite
ostatke.

11.5 Podsjetnik Za Čišćenje

Pećnica vas podsjeća kad je trebate očistiti pirolitičkim čišćenjem.

 bljeska na zaslonu 5 sek. nakon svakog ku-
hanja.

Za isključivanje podsjetnika unesite Izbornik i odaberite Postavke, Podsjetnik Za Čišćenje.

11.6 Kako ukloniti i postaviti: Vrata

Možete ukloniti vrata i unutrašnje staklene ploče kako biste ih očistili. Broj staklenih ploča različit je za različite modele.



UPOZORENJE!

Vrata su teška.



OPREZ!

Pažljivo rukujte staklom, posebno oko rubova prednje ploče. Staklo se može razbiti.

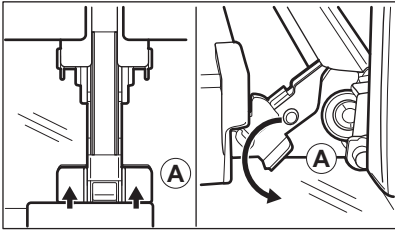
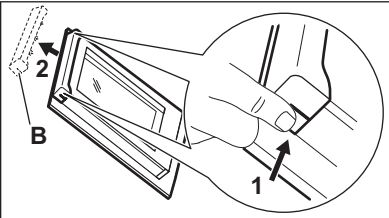
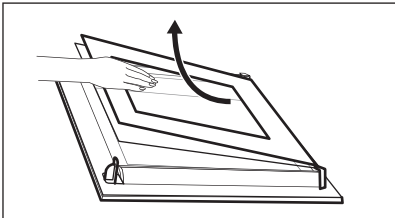
1. korak	Potpuno otvorite vrata.	
2. korak	Podignite i pritisnite stezne poluge (A) na dvjema šarkama vrata.	
3. korak	Vrata pećnice zatvorite do prvog otvorenog položaja (približno pod kutom od 70°). Vrata držite s obje strane i povucite ih od pećnice i pod kutom prema gore. Stavite vrata s vanjskom stranom prema dolje na meku krpu na stabilnu površinu.	
4. korak	Uhvatite oblogu vrata (B) na gornjem rubu vrata s dvije strane i pritisnite prema unutra kako biste oslobodili koplju.	
5. korak	Povucite oblogu vrata prema naprijed kako biste je uklonili.	
6. korak	Držite staklene ploče vrata za gornji rub jedan po jedan i povucite ih prema gore iz vodilice.	
7. korak	Očistite staklenu ploču vodom i sapunicom. Pažljivo osušite staklenu ploču. Staklene ploče ne perite u perilici posuđa.	
8. korak	Nakon čišćenja gore opisane korake obavite obrnutim redoslijedom.	
9. korak	Najprije umetnite manju ploču, zatim veću i vrata. Provjerite jesu li stakla umetnuta u ispravnom položaju jer se u protivnom površina vrata može pregrijati.	

11.7 Kako zamijeniti: Žarulju



UPOZORENJE!

Opasnost od električnog udara.
Žarulja može biti vruća.

RJEŠAVANJE PROBLEMA

Prije zamjene žarulje:		
1. korak	2. korak	3. korak
Isključite pećnicu. Pričekajte dok se pećnica ne ohladi.	Isključite pećnicu iz električnog napajanja.	Na dno unutrašnjosti pećnice stavite krp.

Gornja žarulja

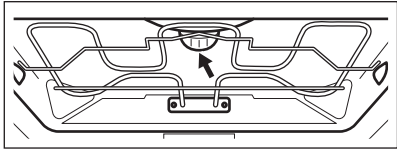
1. korak	Okrenite stakleni poklopac žarulje i skinite ga.	
2. korak	Očistite stakleni poklopac.	
3. korak	Zamijenite žarulju odgovarajućom žaruljom koja je otporna na toplinu od 300 °C.	
4. korak	Postavite stakleni poklopac.	

12. RJEŠAVANJE PROBLEMA



UPOZORENJE!

Pogledajte poglavlja sa sigurnosnim uputama.

12.1 Što učiniti ako ...

Za svaki slučaj koji nije uključen u ovu tablicu obratite se ovlaštenom servisnom centru.

 Pećnica se ne uključuje ili se ne zagrijava	
Problem	Provjerite ako ...
Ne možete uključiti ili koristiti pećnicu.	Pećnica je ispravno spojena na električno napajanje.
Pećnica se ne zagrijava.	Automatsko isključivanje je isključeno.
Pećnica se ne zagrijava.	Vrata pećnice su zatvorena.
Pećnica se ne zagrijava.	Osigurač je pregorio.



Pećnica se ne uključuje ili se ne zagrijava

Pećnica se ne zagrijava.

Isključena je funkcija roditeljska zaštita.



Komponente

Problem

Provjerite ako ...

Svjetlo je isključeno.

Vlažno pečenje - je uključen.

Svjetiljka ne radi.

Žarulja je pregorjela.



Šifre pogreški

Na zaslonu se prikazuje...

Provjerite ako ...

Err C3

Vrata pećnice su zatvorena ili blokada vrata nije slomljena.

Err F102

Vrata pećnice su zatvorena.

Err F102

Blokada vrata nije slomljena.

00:00

Nestalo je struje. Podesite sat.

Ako se na zaslonu prikaže šifra pogreške koja nije u ovoj tablici, isključite kućni osigurač i ponovno uključite pećnicu. Ako se šifra pogreške i dalje pojavljuje, obratite se servisnom centru.



Čišćenje

Problem

Provjerite ako ...

Voda curi iz udubljenja u unutrašnjosti.

Previše je vode u udubini unutrašnjosti pećnice.

12.2 Servisni podaci

Ako sami ne možete pronaći rješenje problema, obratite se vašem zastupniku iliovlaštenom servisu.

ENERGETSKA UČINKOVITOST

Podaci potrebni za servis nalaze se na nazivnoj pločici. Nazivna pločica nalazi se na prednjem okviru unutrašnjosti pećnice. Ne vadite nazivnu pločicu iz unutrašnjosti pećnice.

Preporučujemo da podatke zapišete ovdje:	
Model (MOD.)
Broj proizvoda (PNC)
Serijski broj (S.N.)

13. ENERGETSKA UČINKOVITOST

13.1 Podaci o proizvodu i List s podacima o proizvodu*

Naziv dobavljača	AEG	
Identifikacija modela	BPB351160M 944188506 BPS351160M 944188507	
Indeks energetske učinkovitosti	81.2	
Klasa energetske učinkovitosti	A+	
Potrošnja energije sa standardnim opterećenjem, konvencionalni način rada	1.09 kWh/ciklusu	
Potrošnja energije sa standardnim opterećenjem, rad s ventilatorom	0.69 kWh/ciklusu	
Broj prostora za pečenje	1	
Izvor topline	Električna struja	
Zapremnina	71 l	
Vrsta pećnice	Ugradbena pećnica	
Masa	BPB351160M	34.0 kg
	BPS351160M	34.0 kg

* Za Europsku uniju prema EU Uredbama 65/2014 i 66/2014.
Za Republiku Bjelorusiju prema STB 2478-2017, Dodatak G; STB 2477-2017, Prilozi A i B.
Za Ukrajinu prema 568/32020.

Klasa energetske učinkovitosti nije primjenjiva u Rusiji.

EN 60350-1 - Kućanski električni uređaji za kuhanje - 1. dio: Štednjaci, pećnice, parne pećnice i roštilji - Metode za mjerenje izvedbi.

13.2 Ušteda energije



Pećnica sadrži značajke koje vam pomažu uštedjeti energiju tijekom svakodnevnog kuhanja.

Uvjerite se da su vrata pećnice zatvorena dok pećnica radi. Tijekom kuhanja ne otvarajte vrata pećnice prečesto. Brtvu vrata održavajte čistom i uvjerite se da je dobro pričvršćena u svom položaju.

Da biste povećali uštedu energije, koristite metalno posuđe.

Kad je to moguće, nemojte prethodno zagrijte pećnicu prije pečenja.

Tijekom istovremene pripreme nekoliko jela, neka vremenske pauze između pečenja budu što kraće.

Kuhanje s ventilatorom

Ako je moguće, koristite funkcije kuhanja s ventilatorom kako biste uštedjeli energiju.

Preostala toplina

Ventilator i svjetlo nastavljaju raditi. Kada isključite pećnicu, na zaslonu se prikazuje preostala toplina. Tu toplinu možete koristiti da hranu održite toplom.

Kad je vrijeme kuhanja duže od 30 min, 3 - 10 min prije završetka kuhanja smanjite temperaturu pećnice na minimum. Preostala toplina unutar pećnice nastavit će kuhanje.

Koristite preostalu toplinu za zagrijavanje ostalih jela.

Održavajte jela toplim

Za korištenje preostale topline i održavanje hrane toplom, odaberite najnižu moguću postavku temperature. Na zaslonu se pojavljuje indikator preostale topline ili temperature.

Kuhanje s isključenim svjetlom

Tijekom kuhanja isključite svjetlo. Uključite ga samo kad ga trebate.

Vlažno pečenje

Funkcija je namijenjena je za uštedu energije tijekom kuhanja.

Kad koristite tu funkciju, svjetlo se automatski isključuje nakon 30 sek. Svjetlo možete ponovno uključiti, ali to će smanjiti očekivanu uštedu energije.



14. STRUKTURA IZBORNIKA





14.1 Izbornik



- odaberite za ulazak u Izbornik.



STRUKTURA IZBORNIKA

Izbornik struktura		
Pomoć pri kuhanju 	Čišćenje 	Postavke 

Korak 1	2. korak	3. korak	4. korak	5. korak
	 OK	 O1 - O11	 OK	
Odaberite Izbornik, Postavke.	Potvrdite postavku.	Odaberite postavku.	Potvrdite postavku.	Podesite vrijednost i pritisnite. OK.

Postavke					
O1	Sat	Promijeni	O2	Svjetlina zaslona	1 - 5
O3	Tonovi tipki	1 - Zvučni signal 2 - Klik 3 - Zvuk isključen	O4	Glasnoća zujalice	1 - 4
O5	Tajmer prema gore	Uključeno / Isključeno	O6	Osvjetljenje unutrašnjosti	Uključeno / Isključeno
O7	Brzo zagrijavanje	Uključeno / Isključeno	O8	Podsjetnik Za Čišćenje	Uključeno / Isključeno
O9	Demo način rada	Aktivacijska šifra: 2468	O10	Verzija softvera	Provjera
O11	Resetiraj sve postavke	Da / Ne			

15. BRIGA ZA OKOLIŠ

Reciklirajte materijale sa simbolom . Ambalažu za recikliranje odložite u prikladne spremnike. Pomozite u zaštiti okoliša i ljudskog zdravlja, kao i u recikliranju otpada od električnih i elektroničkih uređaja. Uređaje označene simbolom  ne bacajte zajedno s kućnim otpadom. Proizvod odnesite na lokalno reciklažno mjesto ili kontaktirajte nadležnu službu.

PRO DOKONALÉ VÝSLEDKY

Děkujeme vám, že jste si zvolili výrobek značky AEG. Aby vám bezchybně sloužil mnoho let, vyrobili jsme jej s pomocí inovativních technologií, které usnadňují život, a vybavili funkcemi, které u obyčejných spotřebičů nespíš nenajdete. Aby vám sloužil co nejlépe, stačí věnovat pár minut čtení.

Navštivte naše webové stránky:



Rady k používání, brožury, poradce při potížích a informace o servisu a opravách získáte na:

www.aeg.com/support



Zaregistrujte svůj spotřebič a získáte lepší servis:

www.registreaeg.com



Nákup příslušenství, spotřebního materiálu a originálních náhradních dílů pro váš spotřebič:

www.aeg.com/shop



Stáhněte si aplikaci **My AEG Kitchen**, kde naleznete další recepty, rady a pokyny pro odstraňování potíží.



PÉČE O ZÁKAZNÍKY A SERVIS

Doporučujeme používat originální náhradní díly.

V případě kontaktování našeho autorizovaného servisního střediska mějte u sebe následující údaje: Model, výrobní číslo, sériové číslo.

Tyto informace naleznete na typovém štítku.

 Varování / Důležité bezpečnostní informace

 Všeobecné informace a rady

 Informace o ochraně životního prostředí

Změny vyhrazeny.

OBSAH

1. BEZPEČNOSTNÍ INFORMACE.....	112	2.6 Vnitřní osvětlení.....	117
1.1 Bezpečnost dětí a zranitelných osob.....	112	2.7 Obsluha.....	117
1.2 Všeobecné bezpečnostní informace.....	113	2.8 Likvidace.....	118
2. BEZPEČNOSTNÍ POKYNY	114	3. POPIS SPOTŘEBIČE.....	118
2.1 Instalace.....	114	3.1 Celkový pohled.....	118
2.2 Připojení k elektrické síti.....	115	3.2 Příslušenství.....	118
2.3 Použijte.....	115	4. JAK ZAPNOUT A VYPNOUT TROUBU..	119
2.4 Čištění a údržba.....	116	4.1 Zasunovací ovladače.....	119
2.5 Pyrolytické čištění.....	117	4.2 Ovládací panel.....	119

5. PŘED PRVNÍM POUŽITÍM.....	120	10.3	Tabulky vaření pro zkušební.....	134
5.1 První čištění.....	121	11. ČIŠTĚNÍ A ÚDRŽBA.....	136	
5.2 První přehřátí.....	121	11.1 Poznámky k čištění.....	137	
6. DENNÍ POUŽÍVÁNÍ.....	121	11.2 Jak provádět čištění: Vyrýtá část vnitřku trouby.....	137	
6.1 Jak nastavit: Pečicí funkce.....	121	11.3 Jak vyjmout: Drážky na rošty	137	
6.2 Pečicí funkce.....	122	11.4 Pokyny k použití:		
6.3 Poznámky: Vlhký horkovzduch....	123	Pyrolytická čistící.....	138	
6.4 Jak nastavit:		11.5 Připomínka čištění.....	139	
Podporované Vaření.....	124	11.6		
6.5 Podporované Vaření s recepty....	124	Jak odstranit a nainstalovat: Dvířka...	139	
7. FUNKCE HODIN.....	130	11.7 Jak vyměnit: Osvětlení.....	140	
7.1 Funkce hodin.....	130	12. ODSTRAŇOVÁNÍ ZÁVAD.....	141	
7.2 Jak nastavit: Funkce hodin.....	130	12.1 Co dělat, když.....	141	
8. POUŽITÍ: PŘÍSLUŠENSTVÍ.....	131	12.2 Servisní údaje.....	142	
8.1 Vkládání příslušenství.....	132	13. ENERGETICKÁ ÚČINNOST.....	143	
9. DOPLŇKOVÉ FUNKCE.....	132	13.1 Informace o výrobku a list s údaji o výrobku*.....	143	
9.1 Zámek.....	133	13.2 Úspora energie.....	144	
9.2 Automatické vypnutí.....	133	14. STRUKTURA NABÍDKY.....	144	
9.3 Chladicí ventilátor.....	133	14.1 Nabídka.....	144	
10. TIPY A RADY.....	133			
10.1 Vlhký horkovzduch.....	133			
10.2 Vlhký horkovzduch - doporučená příslušenství.....	134			

1. ⚠️ BEZPEČNOSTNÍ INFORMACE

Tento návod si pečlivě přečtěte ještě před instalací spotřebiče a jeho prvním použitím. Výrobce nenese odpovědnost za žádný úraz ani škodu v důsledku nesprávné instalace nebo použití. Návod k použití vždy uchovávejte na bezpečném a přístupném místě pro jeho budoucí použití.

1.1 Bezpečnost dětí a zranitelných osob

- Tento spotřebič smí používat děti starší osmi let nebo osoby se sníženými fyzickými, smyslovými nebo duševními schopnostmi nebo osoby bez patřičných zkušeností a znalostí, pouze pokud tak činí pod dozorem nebo obdrželi instrukce týkající se bezpečného provozu spotřebiče, a pokud rozumí rizikům spojeným s provozem spotřebiče. Děti

mladší osmi let a osoby s rozsáhlým a komplexním postižením bez stálého dozoru udržujte z dosahu spotřebiče.

- Nenechte děti hrát si se spotřebičem.
- Všechny obaly uschovejte mimo dosah dětí a řádně je zlikvidujte.
- **VAROVÁNÍ:** Je-li spotřebič v provozu nebo pokud chladne, nedovolte dětem a domácím zvířatům, aby se k ní přibližovaly. Přístupné části se při použití zahřívají na vysokou teplotu.
- Je-li spotřebič vybaven dětskou bezpečnostní pojistkou, doporučuje se ji aktivovat.
- Čištění a uživatelskou údržbu spotřebiče by neměly provádět děti bez dozoru.

1.2 Všeobecné bezpečnostní informace

- Tento spotřebič smí instalovat a výměnu kabelu provádět jen kvalifikovaná osoba.
- Nepoužívejte spotřebič, dokud není nainstalován do vestavné konstrukce.
- Před prováděním jakékoli údržby vždy spotřebič odpojte od napájení.
- Jestliže je poškozený napájecí kabel, smí ho vyměnit pouze výrobce, autorizované servisní středisko nebo osoba s podobnou příslušnou kvalifikací, jinak by mohlo dojít k úrazu.
- **VAROVÁNÍ:** Před výměnou žárovky se nejprve přesvědčte, že je spotřebič vypnutý, abyste předešli riziku úrazu elektrickým proudem.
- **VAROVÁNÍ:** Spotřebič a jeho dostupné části se mohou během používání zahřát na vysokou teplotu. Nedotýkejte se topných článků.
- Při vkládání či vyjímání příslušenství či nádobí vždy používejte kuchyňské chňapky.

BEZPEČNOSTNÍ POKYNY

- K odstranění drážek na rošty nejprve odtáhněte přední a poté zadní konec drážek na rošty od stěny trouby. Drážky roštů instalujte stejným postupem v opačném pořadí.
- K čištění spotřebiče nepoužívejte čisticí zařízení na páru.
- Nepoužívejte drsné čisticí prostředky nebo ostré kovové škrabky k čištění skleněných dvířek, mohly by poškrábat povrch, což by mohlo následně vést k rozbití skla.
- Před pyrolytickým čištěním je nutné odstranit nadměrné zbytky jídel. Vyjměte z trouby všechno příslušenství.

2. BEZPEČNOSTNÍ POKYNY

2.1 Instalace



VAROVÁNÍ!

Tento spotřebič smí instalovat jen kvalifikovaná osoba.

- Odstraňte veškerý obalový materiál.
- Poškozený spotřebič neinstalujte ani nepoužívejte.
- Řiďte se pokyny k instalaci dodanými spolu s tímto spotřebičem.
- Při přemísťování spotřebiče buďte vždy opatrní, protože je těžký. Vždy používejte ochranné rukavice a uzavřenou obuv.
- Netahejte spotřebič za držadlo.
- Spotřebič nainstalujte na bezpečném a vhodném místě, které splňuje požadavky na instalaci.
- Dodržujte minimální vzdálenosti od ostatních spotřebičů a nábytku.
- Před instalací spotřebiče ověřte, zda se dvířka trouby otevírají bez omezení.
- Spotřebič je vybaven elektrickým chladicím systémem. Musí být zapojen do elektrické sítě.
- Vestavná jednotka musí splňovat požadavky na stabilitu dle normy DIN 68930.

Minimální výška skříňky (minimální výška skříňky pod pracovní deskou)	578 (600) mm
Šířka skříňky	560 mm
Hloubka skříňky	550 (550) mm
Výška přední části spotřebiče	594 mm
Výška zadní části spotřebiče	576 mm
Šířka přední části spotřebiče	595 mm
Šířka zadní části spotřebiče	559 mm

Hloubka spotřebiče	567 mm
Vestavná hloubka spotřebiče	546 mm
Hloubka s otevřenými dvířky	1027 mm
Minimální velikost ventilačního otvoru. Otvor umístěný na spodní zadní straně	560 x 20 mm
Délka napájecího síťového kabelu. Kabel se nachází v pravém rohu zadní strany	1500 mm
Montážní šrouby	4 x 25 mm

2.2 Připojení k elektrické síti



VAROVÁNÍ!

Hrozí nebezpečí požáru nebo úrazu elektrickým proudem.

- Veškerá elektrická připojení by měla být provedena kvalifikovaným elektrikářem.
- Spotřebič musí být uzemněn.
- Zkontrolujte, zda údaje na typovém štítku souhlasí s parametry elektrické sítě.
- Vždy používejte správně instalovanou síťovou zásuvku s ochranou proti úrazu elektrickým proudem.
- Nepoužívejte rozbočovací zástrčky ani prodlužovací kabely.
- Dbejte na to, abyste nepoškodili napájecí kabel a síťovou zástrčku. Jestliže potřebujete přívodní kabel vyměnit, musí výměnu provést námi autorizované servisní středisko.
- Síťové kabely se nesmí dotýkat nebo se nacházet v blízkosti dvířek spotřebiče nebo výklenku pod spotřebičem, obzvláště je-li spotřebič v provozu nebo jsou-li dvířka horká.
- Ochrana před úrazem elektrickým proudem u živých či izolovaných částí musí být připevněna tak, aby nešla odstranit bez použití nástrojů.
- Síťovou zástrčku zapojte do síťové zásuvky až na konci instalace spotřebiče. Po instalaci musí zůstat síťová zástrčka nadále dostupná.
- Pokud je síťová zásuvka uvolněná, nezapojte do ni síťovou zástrčku.
- Neodpojujte spotřebič ze zásuvky tahem za kabel. Vždy tahejte za zástrčku.
- Používejte pouze správná izolační zařízení: ochranné vypínače vedení, pojistky (pojistky šroubového typu se musí odstranit z držáku), ochranné zemnicí jističe a stykače.
- Je nutné instalovat vhodný vypínač nebo izolační zařízení k řádnému odpojení všech napájecích vodičů spotřebiče. Toto izolační zařízení musí mít mezeru mezi kontakty alespoň 3 mm širokou.
- Před zapojením síťové zástrčky do síťové zásuvky zcela zavřete dvířka spotřebiče.
- Spotřebič se dodává se síťovou zástrčkou a napájecím kabelem.

2.3 Použijte



VAROVÁNÍ!

Hrozí nebezpečí zranění, popálení, úrazu elektrickým proudem či výbuchu.

BEZPEČNOSTNÍ POKYNY

- Tento spotřebič je určen pouze k domácímu (vnitřnímu) použití.
- Neměňte technické parametry spotřebiče.
- Ujistěte se, že větrací otvory nejsou zablokované.
- Během provozu nenechávejte spotřebič bez dozoru.
- Po každém použití spotřebič vypněte.
- Pokud je spotřebič v provozu, buďte při otevírání jeho dvířek opatrní. Může uniknout horký vzduch.
- Nepoužívejte spotřebič, máte-li vlhké ruce, nebo když je v kontaktu s vodou.
- Na otevřená dvířka netlačte.
- Nepoužívejte spotřebič jako pracovní nebo odkládací plochu.
- Dvířka spotřebiče otvírejte opatrně. Používáte-li přísady obsahující alkohol, může vzniknout směs alkoholu a vzduchu.
- Při otvírání dvířek nesmí být v blízkosti spotřebiče jiskry ani otevřený oheň.
- Do spotřebiče, do jeho blízkosti nebo na spotřebič neumísťujte hořlavé předměty nebo předměty nasáklé hořlavinami.



VAROVÁNÍ!

Hrozí nebezpečí poškození spotřebiče.

- Aby nedošlo k poškození nebo změnám barvy smaltu:
 - Nepokládejte nádoby ani jiné předměty přímo na dno spotřebiče.
 - Nepokládejte hliníkovou fólii přímo na dno vnitřku spotřebiče.
 - Nenalévejte vodu přímo do horkého spotřebiče.
 - Po dokončení přípravy jídla nenechávejte ve spotřebiči vlhké talíře ani jídlo.
 - Při vkládání nebo vyjímání příslušenství buďte opatrní.
- Barevné změny na smaltovaném povrchu nebo nerezové oceli nemají vliv na výkon spotřebiče.
- Při pečení vláčných moučníků použijte hluboký plech. Ovočné šťávy mohou zanechat trvalé skvrny.
- Spotřebič je určen výhradně pro přípravu jídel. Nesmí být používán k jiným účelům, například k vytápění místností.
- Vždy pečte se zavřenými dvířky trouby.
- Je-li spotřebič instalován za nábytkovým panelem (např. dvířky), dvířka nábytku nesmí být nikdy zavřená, když je spotřebič v provozu. Za zavřeným nábytkovým panelem může docházet k nárůstu horka a vlhka, což může následně poškodit spotřebič, pouzdro nebo podlahu. Nezavírejte nábytkový panel, dokud spotřebič po použití zcela nevychladne.

2.4 Čištění a údržba



VAROVÁNÍ!

Hrozí nebezpečí poranění, požáru nebo poškození spotřebiče.

- Před čištěním nebo údržbou spotřebič vždy vypněte a vytáhněte síťovou zástrčku ze zásuvky.
- Přesvědčte se, že spotřebič už vychladl. Mohlo by dojít k prasknutí skleněných panelů.
- Poškozené skleněné panely okamžitě vyměňte. Kontaktujte autorizované servisní středisko.
- Při snímání dvířek spotřebiče buďte opatrní. Dvířka jsou těžká!
- Spotřebič čistěte pravidelně, abyste zabránili poškození materiálu jeho povrchu.

- Vyčistěte spotřebič vlhkým měkkým hadrem. Používejte pouze neutrální mycí prostředky. Nepoužívejte prostředky s drsnými částicemi, drátěnky, rozpouštědla nebo kovové předměty.
- Použijete-li sprej do trouby, řiďte se bezpečnostními pokyny uvedenými na jeho balení.

2.5 Pyrolytické čištění



VAROVÁNÍ!

V pyrolytickém režimu hrozí riziko poranění / požáru / chemických emisí (výparů).

- Před použitím samočisticí pyrolytické funkce nebo funkce prvního použití z vnitřku trouby odstraňte následující:
 - jakékoliv zbytky či nánosy jídla, olejů či tuků.
 - jakékoliv vyjímatelné předměty (včetně roštů, bočních kolejniček, apod. dodaných spolu se spotřebičem), obzvláště pak hrnce, pánve a jiné náčiní s nepřilnavým povrchem.
- Pečlivě si přečtěte všechny pokyny ohledně pyrolytického čištění.
- Držte děti z dosahu spotřebiče během chodu pyrolytického čištění. V průběhu této funkce bude spotřebič velmi horký a z předních větracích otvorů bude vycházet horký vzduch.
- Pyrolytické čištění je proces, při kterém se díky vysokým teplotám mohou uvolňovat výpary ze zbytků potravin či konstrukčních materiálů, a zákazníkům se proto důrazně doporučuje následující:
 - během každého pyrolytického čištění a po jeho dokončení zajistit dobré větrání.
 - během prvního použití při maximální teplotě a po jeho dokončení zajistit dobré větrání.
- Na rozdíl od lidí mohou být někteří plazi či ptáci velmi citliví na výpary, k jejichž tvorbě může docházet během čistícího procesu u všech pyrolytických trub.
 - Během chodu pyrolytického čištění odstraňte z blízkosti trouby všechna domácí zvířata (obzvláště ptactvo) a maximální teplotu čištění poprvé použijte v dobře větraném prostoru.
- Malá domácí zvířata mohou být také velmi citlivá na místní změny teploty, ke kterým dochází během samočisticího pyrolytického programu v blízkosti všech pyrolytických trub.
- Při vysokoteplotním pyrolytickém čištění může u všech pyrolytických trub dojít k poškození nepřilnavého povrchu hrnců, pánví, plechů, náčiní apod. a může také vést ke tvorbě méně škodlivých výparů.
- Výpary uvolňované z pyrolytických trub / zbytky jídel nejsou dle jejich popisu škodlivé pro člověka, děti nebo osoby se zdravotními problémy.

2.6 Vnitřní osvětlení



VAROVÁNÍ!

Nebezpečí úrazu elektrickým proudem!

- Pokud jde o žárovku (žárovky) v tomto spotřebiči a samostatně prodávané náhradní žárovky: Tyto žárovky jsou navrženy tak, aby odolaly extrémním fyzickým podmínkám v domácích spotřebičích, ať už jde o teplotu, vibrace či vlhkost, nebo jsou určeny k signalizaci informací o provozním stavu spotřebiče. Nejsou určeny k použití v jiných spotřebičích a nejsou vhodné k osvětlení místností v domácnosti.
- Používejte pouze žárovky se stejnými vlastnostmi .

2.7 Obsluha

- Pro opravu spotřebiče se obraťte na autorizované servisní středisko.
- Používejte výhradně originální náhradní díly.

POPIS SPOTŘEBIČE

2.8 Likvidace



VAROVÁNÍ!

Hrozí nebezpečí úrazu či udušení.

- Odpojte spotřebič od elektrické sítě.
- Odřízněte síťový kabel v blízkosti spotřebiče a zlikvidujte jej.
- Odstraňte dveřní západku, abyste zabránili uvěznění dětí a domácích zvířat ve spotřebiči.

3. POPIS SPOTŘEBIČE

3.1 Celkový pohled

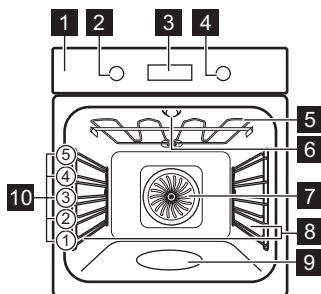

- 1** Ovládací panel
- 2** Volič pečicích funkcí
- 3** Displej
- 4** Ovladač
- 5** Topné těleso
- 6** Osvětlení
- 7** Ventilátor
- 8** Zasouvací mřížka, vyjímatelné
- 9** Polohy mřížky
- 10** Vlis vnitřku trouby

3.2 Příslušenství

Tvarovaný rošt

Pro nádoby na pečení, koláčové formy, pečeně.

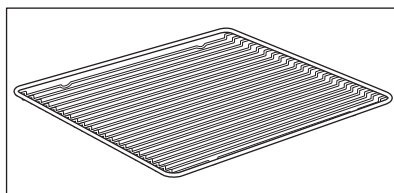

JAK ZAPNOUT A VYPNOUT TROUBU

Plech na pečení

Pro koláče a sušenky.

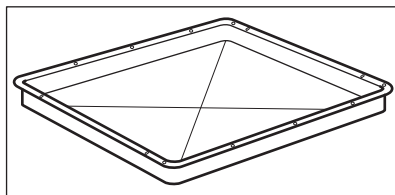

Hluboký pekáč/plech

K pečení a opékání jídel nebo jako plech na zachytávání tuku.

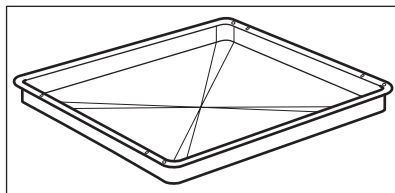

Teleskopické výsuvy

Pro snazší vkládání a vyjímání plechů a tvarovaného roštu.

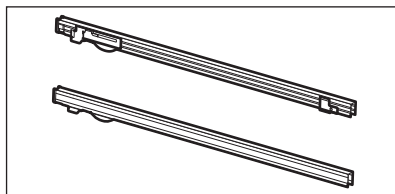







4. JAK ZAPNOUT A VYPNOUT TROUBU



4.1 Zasunovací ovladače

Chcete-li spotřebič použít, stiskněte ovladač. Ovladač se vysune.







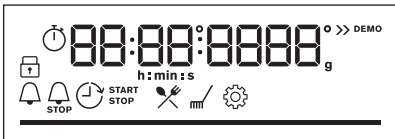

4.2 Ovládací panel

Senzorová tlačítka ovládacího panelu					Stiskněte	Otočte ovladačem
 Časovač	 Rychlé zahřátí	 Osvětlení	 Lock	OK		
K zapnutí trouby zvolte pečicí funkci.						
Troubu vypnete otočením ovladače pečicích funkcí do polohy vypnuto.						

PŘED PRVNÍM POUŽITÍM

	Když je ovladač pečících funkcí v poloze vypnuto, displej se přepne do pohotovostního režimu.
	Při pečení se na displeji zobrazuje nastavená teplota, denní čas a další dostupné funkce.
	Displej s maximálním počtem nastavených funkcí.

Ukazatele na displeji

 Zámek	 Podporované Vaření	 Čištění	 Nastavení	 Rychlé zahřátí
Ukazatele časovače:				

Stavová lišta – pro teplotu nebo čas.



Ukazatel pečení v páře







5. PŘED PRVNÍM POUŽITÍM







VAROVÁNÍ!

Viz kapitoly o bezpečnosti.

5.1 První čištění

Před prvním použitím vyčistěte prázdnou troubu a nastavte čas:			
			 00:00 Nastavte čas. Stiskněte tlačítko OK .





5.2 První předehřátí

 Před prvním použitím prázdnou troubu předehřejte.	
Krok 1	Z trouby odstraňte veškeré příslušenství a vyjímatelné drážky na rošty.
Krok 2	Nastavte maximální teplotu pro funkci  Nechte troubu pracovat jednu hodinu.
Krok 3	Nastavte maximální teplotu pro funkci  Nechte troubu pracovat 15 minut.
 Během předehřívání může z trouby vycházet zápach a kouř. Místnost musí být větraná.	

6. DENNÍ POUŽÍVÁNÍ



 **VAROVÁNÍ!**
Viz kapitoly o bezpečnosti.

6.1 Jak nastavit: Pečicí funkce

Zahájení vaření	
Krok 1	Krok 2
 	 
Nastavte pečicí funkci.	Nastavte teplotu.

Pečení v páře

Přesvědčte se, že je trouba chladná.



Krok 1	Krok 2	Krok 3	Krok 4
			Přehřejte prázdnou troubu po dobu 10 minut k vytvoření vlhkosti. Vložte jídlo do trouby.
Naplňte vlis vnitřku trouby vodou z kohoutku.	Nastavte parní pečicí funkci.	Nastavte teplotu.	
<p>i Maximální objem vlisu vnitřku trouby je 250 ml. Neplňte vlis vnitřku trouby vodou během pečení, nebo když je trouba horká.</p>			









Po dokončení pečení v páře:

Krok 1	Krok 2	Krok 3
Troubu vypnete otočením ovladače pečicích funkcí do polohy vypnuto.	Opatrně otevřete dvířka. Uvolněná vlhkost může způsobit popáleniny.	Přesvědčte se, že je trouba chladná. Odstraňte zbývající vodu z vlisu vnitřku trouby.

6.2 Pečicí funkce

Standardní pečicí funkce

Pečicí funkce	Použití
 <p>Pravý horký vzduch</p>	K pečení jídel na třech úrovních současně a k sušení potravin. Nastavte teplotu o 20–40 °C nižší než pro Horní/spodní ohřev.
 <p>Horní/spodní ohřev</p>	K pečení a opékání jídel na jedné úrovni trouby.

Pečící funkce	Použití
 SteamBake	K dodání vlhkosti během pečení. K získání správné barvy a křupavé kůrky během pečení. K zajištění větší šťavnatosti při opětovném ohřevu. K zavařování ovoce či zeleniny.
 Pizza	K pečení pizzy. K intenzivnějšímu opečení dozlatova a dosažení křupavého korpusu.
 Spodní ohřev	K pečení koláčů s křupavým korpusem a zavařování potravin.
 Mražené potraviny	K přípravě polotovarů do křupava (např. hranolek, amerických brambor nebo jarních závitků).
 Vlhký horkovzduch	Tato funkce slouží k úspoře energie při pečení. Při použití této funkce se teplota ve vnitřku trouby může lišit od nastavené teploty. Je využito zbytkové teplo. Může dojít ke snížení tepelného výkonu. Další informace naleznete v kapitole „Denní používání“, Poznámky: Vlhký horkovzduch.
 Gril	Ke grilování tenkých kusů potravin a opékání chleba.
 Turbo gril	K pečení velkých kusů masa nebo drůbeže s kostmi na jedné úrovni. K zapékání a pečení dozlatova.
 Nabídka	Otevření nabídky: Podporované Vaření, Čištění, Nastavení.

6.3 Poznámky: Vlhký horkovzduch

Tato funkce byla použita ke splnění energetické třídy a požadavků na ekodesign podle směrnice EU 65/2014 a EU 66/2014. Testy podle normy EN 60350-1.





Dvířka trouby by měla být během pečení zavřená, aby nedošlo k přerušení funkce a aby trouba fungovala co nejuspěšněji.

Pokud používáte tuto funkci, osvětlení se automaticky vypne po 30 sekundách.



Pokyny k pečení najdete v kapitole „Tipy a rady“, Vlhký horkovzduch. Pro obecná doporučení ohledně úspory energie viz kapitolu „Energetická účinnost“, Úspora energie.

6.4 Jak nastavit: Podporované Vaření

Každý pokrm v této podnabídce má doporučenou funkci a teplotu. Čas a teplotu lze během pečení upravovat.

Podporované Vaření – tuto funkci použijte k rychlé přípravě pokrmů s výchozími nastaveními:			
Krok 1	Krok 2	Krok 3	Krok 4
			
Otevřete nabídku.	Zvolte Podporované Vaření. Stiskněte OK.	Zvolte pokrm. Stiskněte tlačítko OK.	Vložte jídlo do trouby. Potvrďte nastavení.

6.5 Podporované Vaření s recepty

Legenda	
	Množství vody pro parní funkci.
	Před započítím pečení troubu předehřejte.
	Poloha roštu.













Když funkce skončí, zkontrolujte, zda je jídlo hotové.

	Jídlo	Hmotnost	Poloha roštu / příslušenství	Doba trvání
Hovězí 				























	Jídlo	Hmotnost	Poloha roštu / příslušenství	Doba trvání
P1	Hovězí peče- ně, neprope- čená	1–1,5 kg; 4– 5 cm silné kousky	☐ 2; plech na pečení Maso pod dobu několika minut osmahně- te na horké pánvi. Vložte do trouby.	40 min.
P2	Hovězí peče- ně, středně propečená			50 min.
P3	Hovězí peče- ně, dobře pro- pečená			60 min.
P4	Steak, střed- ně propečený	180–220 g na jeden kus; 3 cm silné plátky	☐ 3; pečicí mísa na tvarovaném ro- štu Maso pod dobu několika minut osmahně- te na horké pánvi. Vložte do trouby.	15 min.
P5	Hovězí peče- ně / dušená (kvalitní žebír- ka, spodní šál, silný bok)	1,5–2 kg	☐ 2; pečicí mísa na tvarovaném roštu Maso pod dobu několika minut osmahně- te na horké pánvi. Přidejte tekutinu. Vlož- te do trouby.	120 min.
P6	Hovězí peče- ně, neprope- čená (nízkote- plotní pečení)	1–1,5 kg; 4– 5 cm silné kousky	☐ 2; plech na pečení Použijte své oblíbené koření nebo jedno- duše sůl a čerstvou mletou papriku. Ma- so pod dobu několika minut osmahněte na horké pánvi. Vložte do trouby.	75 min.
P7	Hovězí peče- ně, středně propečená (nízkoteplotní pečení)			85 min.
P8	Hovězí peče- ně, dobře pro- pečená (nízko- teplotní peče- ní)			130 min.



















DENNÍ POUŽÍVÁNÍ

	Jídlo	Hmotnost	Poloha roštu / příslušenství	Doba trvání
P9	Filet, nepropečený (nízkoteplotní pečení)			75 min.
P10	Filet, středně propečený (nízkoteplotní pečení)	0,5–1,5 kg; 5–6 cm silné kousky	☐ 2; plech na pečení Použijte své oblíbené koření nebo jednoduše sůl a čerstvou mletou papriku. Maso pod dobu několika minut osmahněte na horké pánvi. Vložte do trouby.	90 min.
P11	Filet, propečený (nízkoteplotní pečení)			120 min.
Telecí 🐟				
P12	Telecí pečeně (např. plecko)	0,8–1,5 kg; 4 cm silné kousky	☐ 2; pečicí mísa na tvarovaném roštu Použijte své oblíbené koření. Přidejte tekutinu. Pečte zakryté.	80 min.
Vepřové 🐷				
P13	Pečeně z vepřové krkovičky nebo plecaka	1,5–2 kg	☐ 2; pečicí mísa na tvarovaném roštu V polovině doby pečení maso obraťte.	120 min.
P14	Trhané vepřové LTC	1,5–2 kg	☐ 2; plech na pečení Použijte své oblíbené koření. V polovině doby pečení maso obraťte, aby bylo rovnoměrně opečené.	215 min.
P15	Kýta, čerstvá	1–1,5 kg; 5–6 cm silné kousky	☐ 2; pečicí mísa na tvarovaném roštu Použijte své oblíbené koření.	55 min.
P16	Vepřová žebírka	2–3 kg; použijte syrová, 2–3 cm tenká vepřová žebírka	☐ 3; hluboký pekáč Přidejte tekutinu k zakrytí spodní části pokrmu. V polovině doby pečení maso obraťte.	90 min.
Jehněčí 🐐				



	Jídlo	Hmotnost	Poloha roštu / příslušenství	Doba trvání
P17	Jehněčí stehno s kostmi	1,5–2 kg; 7–9 cm silné kousky	 2; pečicí mísa na plechu na pečení Přidejte tekutinu. V polovině doby pečení maso obraťte.	130 min.
Drůbež 				
P18	Celé kuře	1–1,5 kg; čerstvé	 2;  200 ml; zapékací mísa na plechu na pečení Použijte své oblíbené koření. V polovině doby pečení kuře obraťte, aby bylo rovnoměrně opečené.	60 min.
P19	Půlka kuřete	0,5–0,8 kg	 3 ; plech na pečení Použijte své oblíbené koření.	40 min.
P20	Kuřecí prsa	180–200 g na jeden kus	  2; zapékací mísa na tvárováném roštu Použijte své oblíbené koření. Maso pod dobu několika minut osmahněte na horké pánvi.	25 min.
P21	Kuřecí stehna, čerstvá	-	 3; plech na pečení Pokud jste kuřecí stehna nejprve marinovali, nastavte nižší teplotu a pečte je déle.	30 min.
P22	Kachna, celá	2–3 kg	 2; pečicí mísa na tvárováném roštu Použijte své oblíbené koření. Vložte maso do pečicí nádoby. V polovině doby pečení kachnu obraťte.	100 min.
P23	Husa, celá	4–5 kg	 2; hluboký pekáč Použijte své oblíbené koření. Vložte maso do hlubokého plechu na pečení. V polovině doby pečení husu obraťte.	110 min.
Jiné 				
P24	Sekaná	1 kg	 2; tvárováný rošt Použijte své oblíbené koření.	60 min.

DENNÍ POUŽÍVÁNÍ

	Jídlo	Hmotnost	Poloha roštu / příslušenství	Doba trvání
 Ryba				
P25	Celá ryba, grilovaná	0,5–1 kg na rybu	 2; plech na pečení Rybu naplňte máslem a použijte své oblíbené koření a bylinky.	30 min.
P26	Rybí filé	-	  3; zapékací mísa na tvárováném roštu Použijte své oblíbené koření.	20 min
Sladké pečivo / dezerty   				
P27	Tvarohový koláč	-	 2;  28cm rozkládací forma na pečení na tvárováném roštu	90 min.
P28	Jablečný koláč	-	 2;  100–150 ml; plech na pečení	60 min.
P29	Jablečný koláč	-	 2; forma na koláč na tvárováném roštu	40 min.
P30	Jablečný koláč	-	 2;  100–150 ml;  22cm forma na koláč na tvárováném roštu	60 min.
P31	Brownies - čokoládové sušenky	2 kg	 3; hluboký pekáč	30 min.
P32	Čokoládové muffiny	-	 2;  100–150 ml; plech na muffiny na tvárováném roštu	30 min.
P33	Biskupský chlebíček	-	 2; forma na biskupský chlebíček na tvárováném roštu	50 min.
Zeleninové pokrmy / přílohy   				
P34	Pečené brambory	1 kg	 2; plech na pečení Vložte celé brambory ve slupce na plech na pečení.	50 min.





	Jídlo	Hmotnost	Poloha roštu / příslušenství	Doba trvání
P35	Americké brambory	1 kg	 3; plech na pečení vyložený pečicím papírem Použijte své oblíbené koření. Brambory nakrájejte na kousky.	35 min.
P36	Grilovaná zelenina	1–1,5 kg	 3; plech na pečení vyložený pečicím papírem Použijte své oblíbené koření. Zeleninu nakrájejte na kousky.	30 min.
P37	Krokety, zmražené	0,5 kg	 3; plech na pečení	25 min.
P38	Brambory, zmražené	0,75 kg	 3; plech na pečení	25 min.
Zapékaná jídla, chléb a pizza   				
P39	Lasagne / dušená/zapékaná jídla s nudlemi	1–1,5 kg	 2; zapékač mísa na tvarovaném roštu	45 min
P40	Zapečené brambory	1–1,5 kg	 1; zapékač mísa na tvarovaném roštu	50 min.
P41	Čerstvá pizza, tenká	-	  2;  100 ml; plech na pečení vyložený pečicím papírem	15 min
P42	Čerstvá pizza, silná	-	  2;  100 ml; plech na pečení vyložený pečicím papírem	25 min.
P43	Slaný koláč	-	 2; forma na pečení na tvarovaném roštu	45 min
P44	Bageta / ciabatta / bílý chléb	0,8 kg	  3;  150 ml; plech na pečení vyložený pečicím papírem Pro bílý chléb je třeba více času.	30 min.

FUNKCE HODIN



	Jídlo	Hmotnost	Poloha roštu / příslušenství	Doba trvání
P45	Celozrnný/ žitný/tmavý chléb ve for- mě na biskup- ský chlebiček	1 kg	  2;  150 ml; plech na pečení vyložený pečicím papírem / tvárovany rošt	45 min

7. FUNKCE HODIN





7.1 Funkce hodin

Funkce hodiny	Použití
	Minutka. Po uplynutí času na časovači zazní zvukový signál.
	Čas pečení. Po uplynutí času na časovači zazní zvukový signál a pečicí funkce se vypne.
	Časový odklad. K odložení spuštění nebo ukončení pečení.
	Časovač. Maximum je 23 h 59 min. Tato funkce nemá žádný vliv na provoz trouby. Pro zapnutí a vypnutí Časovač zvolte: Nabídka, Nastavení.

7.2 Jak nastavit: Funkce hodin







Jak nastavit: Denní čas		
Krok 1	Krok 2	Krok 3
		
Pro změnu denního času otevřete nabídku a zvolte Nastavení, Denní čas.	Nastavte hodiny.	Stiskněte: OK.

Jak nastavit: Minutka

Krok 1	Na displeji se zobrazí: 0:00 	Krok 2	Krok 3
			
Stiskněte: 		Nastavte Minutka	Stiskněte: OK.





 Časovač začne okamžitě odpočítávat.

Jak nastavit: Čas pečení

Krok 1	Krok 2	Na displeji se zobrazí: 0:00  STOP	Krok 3	Krok 4
				
Zvolte pečicí funkci a nastavte teplotu.	Opakovaně tiskněte: 		Nastavte dobu přípravy.	Stiskněte: OK.

 Časovač začne okamžitě odpočítávat.

Jak nastavit: Časový odklad

Krok 1	Krok 2	Na displeji se zobrazí: denní čas  ZAPNOUT	Krok 3	Krok 4	Na displeji se zobrazí: --:--  VYPNOUT	Krok 5	Krok 6
							
Zvolte pečicí funkci.	Opakovaně tiskněte: 		Nastavte čas spuštění.	Stiskněte: OK.		Nastavte čas ukončení.	Stiskněte: OK.

 Časovač začne odpočítávat v nastavený čas spuštění.

8. POUŽITÍ: PŘÍSLUŠENSTVÍ

8.1 Vkládání příslušenství

Malý zářez nahoře zajišťuje vyšší bezpečnost. Tyto zářezy také fungují jako zařízení proti překlopení. Vysoký okraj kolem roštu slouží jako ochrana proti sklouznutí varných nádob z roštu.

Tvarovaný rošt:

Rošt zasuněte mezi vodící lišty drážek rošťů.

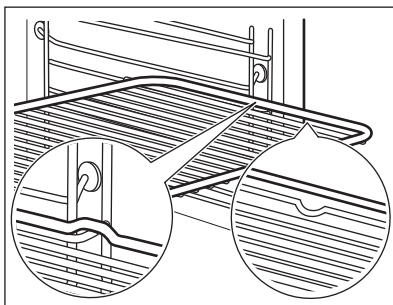

Plech na pečení /Hluboký pekáč:

Zasuňte plech mezi drážky zvolené úrovně roštu.

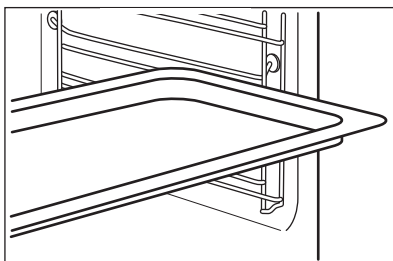

Tvarovaný rošt, Plech na pečení /Hluboký pekáč:

Plech zasuněte mezi drážky zvolené úrovně roštu a tvarovaný rošt v drážkách nad nimi.

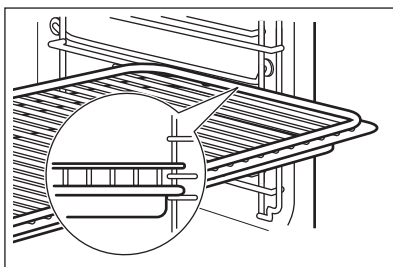

9. DOPLŇKOVÉ FUNKCE

9.1 Zámek

Tato funkce brání náhodné změně funkce trouby.

Pokud ji zapnete, když trouba pracuje, nastavená příprava jídla bude pokračovat a ovládací panel bude zablokovaný.

Pokud ji zapnete, když je trouba vypnutá, troubu nepůjde zapnout a ovládací panel bude zablokovaný.





 – stisknutím a podržením funkce zapnete. Zazní zvukový signál.

 – stisknutím a podržením funkce vypnete.

 3x  – bliká při zapnutí zámku.

9.2 Automatické vypnutí

Pokud je spuštěna nějaká pečicí funkce a vy nezměníte žádné nastavení, trouba se po určité době z bezpečnostních důvodů vypne.

 (°C)	 (h)
30 - 115	12.5
120 - 195	8.5
200 - 245	5.5
250 – maximální	3

Automatické vypnutí nefunguje s funkcemi: Osvětlení, Časový odklad.



9.3 Chladicí ventilátor

Když je trouba v provozu, chladicí ventilátor se automaticky zapne, aby udržoval povrch trouby chladný. Jestliže troubu vypnete, bude chladicí ventilátor pokračovat v chlazení až do úplného ochlazení trouby.

10. TIPY A RADY

10.1 Vlhký horkovzduch

Nejlépešších výsledků dosáhnete, budete-li se řídit doporučenou dobou pečení v tabulce níže. Použijte třetí polohu roštu.

	 (°C)	 (min)
Zapečené těstoviny	200 - 220	45 - 55
Zapečené brambory	180 - 200	70 - 85
Moussaka	170 - 190	70 - 95
Lasagne	180 - 200	75 - 90
Zapečené cannelloni	180 - 200	70 - 85
Chlebový pudink	190 - 200	55 - 70
Rýžový pudink	170 - 190	45 - 60
Jablečný koláč z piškotového těsta (kulatá dortová forma na pečení)	160 - 170	70 - 80
Bílý chléb	190 - 200	55 - 70

10.2 Vlhký horkovzduch - doporučená příslušenství

Používejte formy a nádoby z tmavého kovu a s povrchovou vrstvou. Pohlcují teplo lépe než nádoby ze světlého kovu a s reflexní úpravou.

			
Plech na pizzu	Zapékací mísa	Pečicí šálky	Dortový korpus
Tmavý, nereflexní Průměr 28 cm	Tmavý, nereflexní Průměr 26 cm	Keramika Průměr 8 cm, výška 5 cm	Tmavý, nereflexní Průměr 28 cm





10.3 Tabulky vaření pro zkušebny

Informace pro zkušebny

Testy podle normy: EN 60350, IEC 60350.



PEČENÍ NA JEDNÉ ÚROVNI. Pečení ve formě





		 (°C)	 (min)	
Piškotový koláč bez tuku	Pravý horký vzduch	140 - 150	35 - 50	2
Piškotový koláč bez tuku	Horní/spodní ohřev	160	35 - 50	2
Jablečný koláč, 2 formy na pečení, Ø 20 cm	Pravý horký vzduch	160	60 - 90	2
Jablečný koláč, 2 formy na pečení, Ø 20 cm	Horní/spodní ohřev	180	70 - 90	1









PEČENÍ NA JEDNÉ ÚROVNI. Sušenky









Použijte třetí polohu roštu.

		 (°C)	 (min)
Máslové sušenky / Proužky těsta	Pravý horký vzduch	140	25 - 40
Máslové sušenky / Proužky těsta, předehřejte prázdnou troubu	Horní/spodní ohřev	160	20 - 30
Malé koláče, 20 kousků na plech, předehřejte prázdnou troubu	Pravý horký vzduch	150	20 - 35
Malé koláče, 20 kousků na plech, předehřejte prázdnou troubu	Horní/spodní ohřev	170	20 - 30

ČIŠTĚNÍ A ÚDRŽBA

 PEČENÍ NA VÍCE ÚROVNÍCH. Sušenky				
		 (°C)	 (min)	
Máslové sušenky / Proužky těsta	Pravý horký vzduch	140	25 - 45	1 / 4
Malé koláče, 20 kousků na plech, předehřejte prázdnou troubu	Pravý horký vzduch	150	23 - 40	1 / 4
Piškotový koláč bez tuku	Pravý horký vzduch	160	35 - 50	1 / 4

 GRIL				
 Předehřejte prázdnou troubu po dobu pěti minut.				
 Gril s maximálním nastavením teploty.				
		 (min)		
Topinky	Gril	1 - 3	5	
Hovězí steak, v polovině doby obraťte	Gril	24 - 30	4	



11. ČIŠTĚNÍ A ÚDRŽBA



VAROVÁNÍ!

Viz kapitoly o bezpečnosti.

11.1 Poznámky k čištění

 <p>Čistící prostředky</p>	Přední stranu trouby otřete měkkým hadříkem namočeným v roztoku teplé vody a šetrného mycího prostředku.
	Kovové plochy očistěte pomocí čistícího roztoku.
	Skvrny vyčistěte pomocí šetrného čistícího prostředku.
 <p>Každodenní použití</p>	Vnitřek trouby očistěte po každém použití. Hromadění mastnoty či zbytků jídel může způsobit požár.
	Neuchovávejte potraviny v troubě déle než 20 minut. Osušte vnitřek měkkým hadrem po každém použití.
 <p>Příslušenství</p>	Vyčistěte všechno příslušenství po každém použití a nechte jej vysušit. Použijte měkký hadr a vlažnou vodu s šetrným mycím prostředkem. Nečistěte příslušenství v myčce nádobí
	Nepřilnavé příslušenství nečistěte pomocí abrazivních čistících prostředků nebo ostrých předmětů.

11.2 Jak provádět čištění: Vyrytá část vnitřku trouby

Po pečení v páře vyčistěte vlis vnitřku trouby a odstraňte usazeniny vodního kamene.

Krok 1	Krok 2	Krok 3
Nalijte do vlisu vnitřku trouby 250 ml bílého octa. Použijte maximálně 6% ocet bez jakýchkoliv přísad.	Nechte ocet rozpustit usazeniny vodního kamene při pokojové teplotě po dobu 30 minut.	Vnitřek trouby umyjte vlažnou vodou a měkkým hadrem.
V případě funkce: SteamBake čistěte troubu každých 5–10 cyklů pečení.		

11.3 Jak vyjmout: Drážky na rošty

K vyčištění trouby vyjměte drážky na rošty.

ČIŠTĚNÍ A ÚDRŽBA

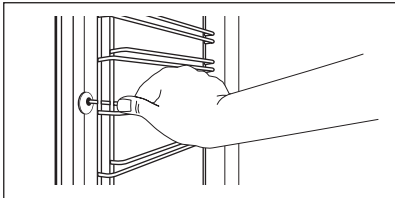
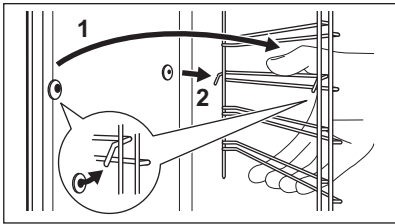
Krok 1	Vypněte troubu a vyčkejte, dokud nevychladne.	
Krok 2	Odtáhněte přední část drážek na rošty od stěny trouby.	
Krok 3	Odtáhněte zadní konec drážek na rošty od stěny trouby a vytáhněte je ven.	
Krok 4	Drážky na rošty instalujte stejným postupem v opačném pořadí. Zarážky na teleskopických výsuvkách musí směřovat dopředu.	

11.4 Pokyny k použití: Pyrolytická čističí

Vyčistěte troubu pomocí Pyrolytická čističí.



VAROVÁNÍ!

Hrozí nebezpečí popálení.



POZOR!



Jsou-li ve stejné skříni instalovány další spotřebiče, nepoužívejte je současně s touto funkcí. Trouba by se mohla poškodit.

Před Pyrolytická čističí:

Vypněte troubu a vyčkejte, dokud nevychladne.	Vyjměte všechno příslušenství a vyjímatelné drážky na rošty.	Dno trouby a vnitřní sklo dveřík otřete měkkým hadříkem namočeným v roztoku teplé vody a šetrného mycího prostředku.
---	--	--

Pyrolytická čističí

Krok 1	Vstupte do nabídky: Čištění $\text{mm} /$.	
	Funkce	Délka
	C1 - Lehké čištění	1 h
	C2 - Normální čištění	1 h 30 min

Pyrolytická čisticí	
C3 - Důkladné čištění	3 h
Krok 2	OK – stisknutím vyberete čisticí program.
Krok 3	OK – stisknutím spustíte čištění.
Krok 4	Po čištění otočte ovladačem pečicích funkcí do polohy vypnuto.
 Během čištění je osvětlení vnitřku trouby vypnuté.	
Jakmile trouba dosáhne nastavené teploty, dvířka se zablokují. Až do odemčení dvířek je na displeji zobrazeno:  .	



Po ukončení čištění:		
Vypněte troubu a vyčkejte, dokud nevychladne.	Vnitřek trouby vytřete měkkým hadříkem.	Ze dna trouby odstraňte veškeré zbytky.

11.5 Připomínka čištění

Trouba vás upozorní, kdy je nutné ji vyčistit pomocí pyrolytického čištění.	
 bliká na displeji po každém pečení po dobu 5 sekund.	K vypnutí připomínky zadejte Nabídka a zvolte Nastavení, Připomínka čištění.

11.6 Jak odstranit a nainstalovat: Dvířka

Dvířka a vnitřní skleněné panely lze za účelem čištění demontovat. Počet skleněných panelů se liší dle modelu.

 VAROVÁNÍ! Dvířka jsou těžká.
 POZOR! Se sklem manipulujte opatrně, především u hran předního skleněného panelu. Sklo může prasknout.

ČIŠTĚNÍ A ÚDRŽBA

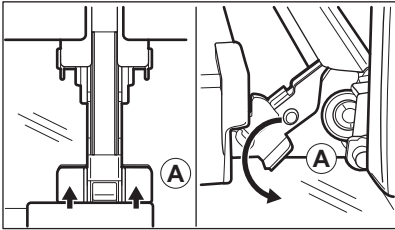
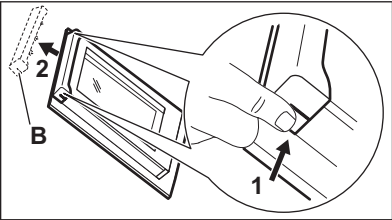
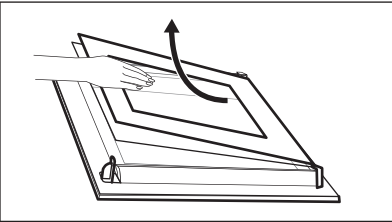
Krok 1	Zcela otevřete dvířka.	
Krok 2	Nadzdvihněte a stiskněte upínací páčky (A) na obou dveřních závěsech až na doraz.	
Krok 3	Privřete dvířka trouby do první polohy otevření (přibližně do úhlu 70°). Podržte dvířka na obou stranách a vytáhněte je směrem šikmo vzhůru od trouby. Dvířka položte vnější stranou dolů na měkkou látku na rovné podložce.	
Krok 4	Uchopte okrajovou lištu (B) na horní straně dvířek na obou stranách a zatlačením směrem dovnitř uvolněte svorku těsnění.	
Krok 5	Vytáhněte okrajovou lištu dopředu a vyjměte ji.	
Krok 6	Uchopte skleněné panely jednu po druhé na jejich horní straně a vytáhněte je z drážek směrem nahoru.	
Krok 7	Skleněný panel omyjte vodou s mycím prostředkem. Skleněný panel pečlivě osušte. Skleněné panely nemyjte v myčce nádobí.	
Krok 8	Po čištění proveďte výše uvedené kroky v opačném pořadí.	
Krok 9	Nejprve nainstalujte menší a potom větší panel a dvířka. Ujistěte se, že jsou skleněné panely vloženy do správné polohy, jinak by se mohl povrch dvířek přehřívát.	

11.7 Jak vyměnit: Osvětlení



VAROVÁNÍ!

Nebezpečí úrazu elektrickým proudem.
Žárovka může být horká.

Před výměnou osvětlení:

Krok 1	Krok 2	Krok 3
Vyprňte troubu. Počkejte, dokud trouba nevychladne.	Odpojte troubu od elektrické sítě.	Na dno vnitřku trouby položte utěrku.

Horní žárovka

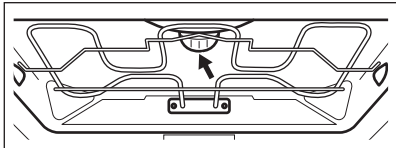
Krok 1	Skleněným krytem otočte a sejměte jej.	
Krok 2	Skleněný kryt vyčistěte.	
Krok 3	Žárovku vyměňte za vhodnou žárovku žáruvzdornou do 300 °C.	
Krok 4	Nasadte skleněný kryt.	

12. ODSTRAŇOVÁNÍ ZÁVAD



VAROVÁNÍ!

Viz kapitoly o bezpečnosti.

12.1 Co dělat, když...

Ve všech případech, které nejsou v této tabulce zahrnuty, se obraťte na autorizované servisní středisko.



Trouba se nezapne nebo se neohřívá

Problém	Zkontrolujte, zda...
Troubu nelze zapnout ani používat.	Trouba je správně zapojená do elektrické sítě.
Trouba nehřeje.	Funkce automatického vypnutí je vypnutá.
Trouba nehřeje.	Dvířka trouby jsou zavřená.
Trouba nehřeje.	Není spálená pojistka.

ODSTRAŇOVÁNÍ ZÁVAD



Trouba se nezapne nebo se neohřívá

Trouba nehřeje.

Dětská bezpečnostní pojistka je vypnutá.



Součásti

Problém

Zkontrolujte, zda...

Osvětlení je vypnuté.

Vlhký horkovzduch – je zapnuté.

Osvětlení nefunguje.

Spálená žárovka.



Chybové kódy

Na displeji se zobrazuje...

Zkontrolujte, zda...

Chyba C3

Dvířka trouby jsou zavřená nebo není rozbitý zámek dveří.

Chyba F102

Dvířka trouby jsou zavřená.

Chyba F102

Zámek dveří není rozbitý.

00:00

Došlo k výpadku proudu. Nastavte denní čas.

Pokud se na displeji zobrazuje chybový kód, který není obsažen v této tabulce, restartujte troubu vypnutím a opětovným zapnutím domovní pojistky. Pokud se chybový kód zobrazí znovu, kontaktujte autorizované servisní středisko.



Čištění

Problém

Zkontrolujte, zda...

Z vlisu vnitřku trouby vytéká voda.

Ve vlisu vnitřku trouby je příliš mnoho vody.

12.2 Servisní údaje

Pokud problém nemůžete vyřešit sami, obraťte se na svého prodejce nebo autorizované servisní středisko.

Potřebné údaje pro servisní středisko najdete na typovém štítku. Typový štítek se nachází na předním rámu vnitřní části trouby. Nesundávejte typový štítek z vnitřní části trouby.

Doporučujeme, abyste si údaje napsali zde:	
Model (MOD.)
Výrobní číslo (PNC)
Sériové číslo (SN)

13. ENERGETICKÁ ÚČINNOST

13.1 Informace o výrobku a list s údaji o výrobku*

Název dodavatele	AEG	
Označení modelu	BPB351160M 944188506 BPS351160M 944188507	
Index energetické účinnosti	81.2	
Třída energetické účinnosti	A+	
Spotřeba energie se standardním zatížením, konvenční režim	1.09 kWh/cyklus	
Spotřeba energie se standardním zatížením, intenzivní horkovzdušný režim	0.69 kWh/cyklus	
Počet pečicích prostorů	1	
Tepelný zdroj	Elektrická energie	
Objem	71 l	
Typ trouby	Vestavná trouba	
Hmotnost	BPB351160M	34.0 kg
	BPS351160M	34.0 kg

STRUKTURA NABÍDKY

* Pro Evropskou unii v souladu se směrnicemi EU 65/2014 a 66/2014.
Pro Běloruskou republiku v souladu s STB 2478-2017, příloha G; STB 2477-2017, dodatky A a B.
Pro Ukrajinu v souladu s 568/32020.

Třída energetické účinnosti neplatí pro Rusko.

EN 60350-1 - Elektrické spotřebiče na vaření pro domácnost - část 1: Sporáky, trouby, parní trouby a grily - Metody měření funkce.

13.2 Úspora energie



Trouba je vybavena funkcemi, které vám pomohou ušetřit energii při každodenním pečení.

Při provozu spotřebiče se přesvědčte, že jsou dvířka trouby zavřená. Během pečení neotvírejte dvířka trouby příliš často. Těsnění dvířek udržujte čisté a kontrolujte, zda je na svém místě řádně uchyceno.

Pro účinnější úsporu energie používejte kovové nádoby.

Je-li to možné, troubu před pečením nepředehřívejte.

Připravujete-li několik jídel najednou, snažte se, aby prodlevy při pečení byly co nejkratší.

Horkovzdušné pečení

Je-li to možné, pro úsporu energie používejte funkce pečení s ventilátorem.

Zbytkové teplo

Ventilátor a osvětlení nadále pracují. Po vypnutí trouby se na displeji zobrazuje zbytkové teplo.

Toto teplo můžete využít k udržení teploty jídla.

Je-li doba pečení delší než 30 minut, snižte teplotu trouby na minimum 3–10 minut před koncem pečení. Pečení bude pokračovat i díky zbytkovému teplu uvnitř trouby.

Zbytkové teplo můžete využít k ohřevu jiného jídla.

Uchování teploty jídla

Chcete-li využít zbytkové teplo k uchování teploty pokrmu, zvolte nejnižší možné nastavení teploty. Na displeji se zobrazí ukazatel zbytkového tepla nebo teplota.

Pečení s vypnutým osvětlením

Při pečení vypněte osvětlení. Zapněte ho pouze tehdy, když ho skutečně potřebujete.

Vlhký horkovzduch

Tato funkce slouží k úspoře energie při pečení.



Pokud používáte tuto funkci, osvětlení se automaticky vypne po 30 sekundách. Osvětlení můžete znovu zapnout, ale omezíte tím předpokládanou úsporu energie.

14. STRUKTURA NABÍDKY

14.1 Nabídka





– zvolte pro zadání Nabídka.

Nabídka struktura		
Podporované Vaření 	Čištění 	Nastavení 

Krok 1	Krok 2	Krok 3	Krok 4	Krok 5
				
Zvolte Nabídka, Nastavení.	Potvrďte nastavení.	Zvolte nastavení.	Potvrďte nastavení.	Upravte hodnotu a stiskněte OK.

Nastavení					
O1	Denní čas	Změnit	O2	Displej jas	1 - 5
O3	Tóny tlačítek	1 – Pípnutí 2 – Cvaknutí 3 – Zvuk vypnutý	O4	Hlasitost zv. signalizace	1 - 4
O5	Časovač	Zap/Vyp	O6	Osvětlení	Zap/Vyp
O7	Rychlé zahřátí	Zap/Vyp	O8	Připomínka čištění	Zap/Vyp
O9	Režim demo	Aktivační kód: 2468	O10	Verze software	Kontrola
O11	Zrušit všechna nastavení	Ano/Ne			

15. POZNÁMKY K OCHRANĚ ŽIVOTNÍHO PROSTŘEDÍ

Recyklujte materiály označené symbolem . Obaly vyhodte do příslušných odpadních kontejnerů k recyklaci. Pomáhejte chránit životní prostředí a lidské zdraví a recyklovat elektrické a elektronické spotřebiče určené k likvidaci. Spotřebiče označené příslušným symbolem  nelikvidujte spolu s domovním odpadem. Spotřebič odevzdejte v místním sběrném dvoře nebo kontaktujte místní úřad.

PARIMATE TULEMUSTE SAAVUTAMISEKS

Täname, et valisite selle AEG toote. Töötasime selle välja, et saaksite palju aastaid nautida laitmatuid tulemusi, ning lisasime elu lihtsustavaid uuenduslikke funktsioone, mida te tavaliste seadmete juures ei pruugi leida. Leidke mõni minut aega ning lugege, kuidas seadmega parimaid tulemusi saavutada.

Külastage meie veebisaiti, kust leiate



nõuandeid, brošüüre, tõrkeotsingu, remondi- ja hooldusteavet:
www.aeg.com/support



Paremaks teeninduseks registreerige oma toode aadressil
www.registeraeg.com



Ostke oma seadmele lisaseadmeid, tarvikuid ja originaalvaruosi aadressil
www.aeg.com/shop



Täiendavate retseptide, näpunäidete ja tõrkeotsingu juhendi saamiseks laadige alla rakendus **My AEG Kitchen**.



KLIENDITEENINDUS JA HOOLDUS

Alati tuleb kasutada originaalvaruosi.

Volitatud teeninduskeskusesse pöördumisel peaksid teil olema varuks alljärgnevad andmed: mudel, osanumber (PNC), seerianumber.

Teave on toodud andmeplaadil.

Hoiatused / Ettevaatusabinõud – ohutusteave

Üldine teave ja vihjed

Keskkonnateave

Jäetakse õigus teha muutusi.

SISUKORD

1. OHUTUSINFO	147	2.7 Hooldus	152
1.1 Laste ja haavatavate inimeste turvalisus.....	147	2.8 Kõrvaldamine.....	152
1.2 Üldine ohutus.....	148	3. TOOTE KIRJELDUS	153
2. OHUTUSJUHISED	149	3.1 Üldine ülevaade.....	153
2.1 Paigaldamine.....	149	3.2 Lisatarvikud.....	153
2.2 Elektriühendus.....	150	4. AHJU SISSE- JA VÄLJALÜLITAMINE ... 154	
2.3 Kasutamine.....	150	4.1 Sisselükatavad nupud.....	154
2.4 Puhastus ja hooldus.....	151	4.2 Juhtpaneel.....	154
2.5 Pürolüüspuhastamine.....	152	5. ENNE ESIMEST KASUTAMIST	155
2.6 Sisevalgustus.....	152	5.1 Esmane puhastamine.....	156

5.2 Algne eelkuumutamine.....	156	10.2 Niiske küpsetus pöördõhuga - soovitavad tarvikud.....	168
6. IGAPÄEVANE KASUTAMINE.....	156	10.3 Küpsetustabelid testimisasutustele.....	169
6.1		11. PUHASTUS JA HOOLDUS.....	171
Kuidas seadistada: Küpsetusrežiimid	156	11.1 Juhised puhastamiseks.....	171
6.2 Küpsetusrežiimid.....	157	11.2 Kuidas puhastada: Veesüvend..	172
6.3 Märkused: Niiske küpsetus pöördõhuga.....	158	11.3 Kuidas eemaldada: restitoed	172
6.4 Kuidas seadistada: Juhendatud küpsetamine.....	159	11.4 Kuidas kasutada: Pürolüüspuhastamine.....	172
6.5 Juhendatud küpsetamine retseptidega.....	159	11.5 Puhastamise meeldetuletus.....	174
7. KELLA FUNKTSIOONID.....	164	11.6 Kuidas eemaldada ja paigaldada: Uk s.....	174
7.1 Kella funktsioonid.....	164	11.7 Kuidas asendada: lamp.....	175
7.2 Kuidas seadistada: Kella funktsioonid.....	165	12. VEAOTSING.....	175
8. KUIDAS KASUTADA: TARVIKUD.....	166	12.1 Mida teha, kui.....	176
8.1 Tarvikute sisestamine.....	166	12.2 Hooldusteave.....	177
9. LISAFUNKTSIOONID.....	167	13. ENERGIATÕHUSUS.....	177
9.1 Lukk.....	167	13.1 Tooteteave ja toote infoleht*	177
9.2 Automaatne väljalülitus.....	167	13.2 Energia kokkuhoid.....	178
9.3 Jahutusventilaator.....	168	14. MENÜÜ STRUKTUUR.....	179
10. VIHJEID JA NÄPUNÄITEID.....	168	14.1 Menüü.....	179
10.1 Niiske küpsetus pöördõhuga.....	168		

1. ⚠ OHUTUSINFO

Enne seadme paigaldamist ja kasutamist lugege kaasasolev juhend tähelepanelikult läbi. Tootja ei võta endale vastutust vigastuste või varalise kahju eest, mis on tingitud paigaldusnõuete eiramisest või väärast kasutusest. Hoidke kasutusjuhend kindlas kohas alles, et saaksite seda vajadusel vaadata.

1.1 Laste ja haavatavate inimeste turvalisus

- Vähemalt 8-aastased ja vanemad lapsed ning piiratud füüsiliste, sensorsete või vaimsete võimete või väheste kogemuste ja teadmistega isikud tohivad seda seadet kasutada järelevalve all või kui neid on õpetatud seadet ohutul viisil kasutama ja mõistma kaasnevaid ohte. Lapsed

vanuses kuni 8 aastat ning raske või väga keerulise puudega isikud tuleks hoida seadmest eemal, kui neil ei saa pidevalt silma peal hoida.

- Tuleb jälgida, et lapsed ei mängiks seadmega ega.
- Hoidke pakendimaterjal lastele kättesaamatus kohas ja kõrvaldage see nõuetekohaselt.
- HOIATUS: Hoidke lapsed ja lemmikloomad seadmest eemal, kui see töötab või jahtub. Kasutamisel võivad juurdepääsetavad osad minna kuumaks.
- Kui seadmel on olemas laste ohutusseade, tuleks see sisse lülitada.
- Lapsed ei tohi ilma järelvalveta seadet puhastada ega hooldustoiminguid läbi viia.

1.2 Üldine ohutus

- Seadme paigaldamine ja toitekaablit vahetamine on lubatud ainult kvalifitseeritud elektrikule!
- Ärge kasutage seadet enne, kui see on köögimööblisse sisse ehitatud.
- Enne mis tahes hooldustöid ühendage seade vooluvõrgust lahti.
- Kui toitejuhe on vigastatud, laske see elektriohutuse tagamiseks välja vahetada tootja, selle volitatud hooldekeskuse või vastavat kvalifikatsiooni omava isiku poolt.
- HOIATUS! Elektrilöögi ärahoidmiseks tuleb seade enne ahjuvalgusti vahetamist kindlasti välja lülitada.
- HOIATUS! Seade ja selle juurde kuuluvad osad lähevad kasutamise ajal kuumaks. Olge ettevaatlik, et te kütteelemente ei puutuks.
- Tarvikute või ahjunõude eemaldamisel või sisestamisel kasutage alati pajakindaid.
- Ahjuplaadi tugede eemaldamiseks tõmmake esmalt plaaditoe esiots ja seejärel tagumine ots külgseina küljest

lahti. Paigaldage ahjuplaadi toed tagasi vastupidises järjekorras.

- Ärge kasutage seadme puhastamiseks aurupuhastit.
- Ärge kasutage ukseklaasi puhastamiseks karedaid, abrasiivseid puhasteid ega teravaid metallist kaabitsaid, sest need võivad klaasi pinda kriimustada, mille tagajärjel võib klaas puruneda
- Väljavalgunud liigne vedelik tuleb enne pürolüütilist puhastamist eemaldada. Eemaldage ahjust kõik osad.

2. OHUTUSJUHISED

2.1 Paigaldamine



HOIATUS!

Seadet tohib paigaldada ainult kvalifitseeritud tehnik.

- Eemaldage kõik pakkematerjalid.
- Kahjustatud seadet ei tohi paigaldada ega kasutada.
- Järgige seadmega kaasasolevaid paigaldusjuhiseid.
- Kuna seade on raske, olge selle liigutamisel ettevaatlik. Kasutage töökindaid ja kinnisi jalanõusid.
- Ärge tõmmake seadet käepidemest.
- Paigaldage seade ohutusse ja sobivasse kohta, mis vastab paigaldusnõuetele.
- Tagage minimaalne kaugus muudest seadmetest ja mööbliesemetest.
- Enne seadme paigaldamist kontrollige, kas ahjuuks avaneb takistusteta.
- Seade on varustatud elektrilise jahutussüsteemiga. See tuleb ühendada elektritoitesüsteemiga.
- Integreeritud seade peab vastama standardi DIN 68930 stabiilsusnõuetele.

Kapi minimaalne kõrgus (tööpinna all asuva kapi minimaalne kõrgus)	578 (600) mm
Kapi laius	560 mm
Kapi sügavus	550 (550) mm
Seadme esiosa kõrgus	594 mm
Seadme tagaosaga kõrgus	576 mm
Seadme esiosa laius	595 mm
Seadme tagaosaga laius	559 mm

Seadme sügavus	567 mm
Sisseehitatud seadme sügavus	546 mm
Sügavus avatud uksega	1027 mm
Ventilatsiooniava minimaalne suurus. Ava asub põhja tagumises osas	560 x 20 mm
Toitejuhtme pikkus. Juhe asub tagumisel küljel parempoolses nurgas	1500 mm
Kinnituskrivid	4 x 25 mm

2.2 Elektriühendus



HOIATUS!

Tulekahju- ja elektrilöögioht!

- Kõik elektriühendused peab teostama kvalifitseeritud elektrik.
- Seade peab olema maandatud.
- Kontrollige, kas andmeplaadil olevad elektriandmed vastavad teie kohaliku vooluvõrgu näitajatele.
- Kasutage alati nõuetekohaselt paigaldatud elektriõhutat pistikupesa.
- Ärge kasutage mitmikpistikuid ega pikenduskaableid.
- Veenduge, et te ei vigastaks toitepistikut ega -juhet. Kui seadme toitekaabel tuleb välja vahetada, siis pöörduge meie hoolduskeskusse.
- Jälgige, et toitejuhe ei puutuks vastu seadme ust ega oleks uksele lähedal või seadme all olevas nišis, eriti siis, kui seade töötab või uks on kuum.
- Isoleeritud ja isoleerimata osad peavad olema kinnitatud nii, et neid ei saaks ilma tööriistadeta eemaldada.
- Ühendage toitepistik seinakontakti alles pärast paigalduse lõpuleviimist. Veenduge, et pärast paigaldamist säilib juurdepääs toitepistikule.
- Kui seinakontakt logiseb, ärge pange sinna toitepistikut.
- Seadet vooluvõrgust eemaldades ärge tõmmake toitekaablist. Võtke alati kinni pistikust.
- Kasutage ainult õigeid isolatsiooniseadiseid: kaitselüliteid, kaitsmeid (keermega kaitsmed tuleb pesast eemaldada), maalekkevoolu kaitsmeid ja kontaktoreid.
- Seadme ühendus vooluvõrguga tuleb varustada mitmepooluselise isolatsiooniseadisega. Isolatsiooniseadise lahutatud kontaktide vahemik peab olema vähemalt 3 mm.
- Enne toitejuhtme pistikusse sisestamist sulgege korralikult seadme uks.
- Seadmega kaasnevad toitekaabel ja toitepistik.

2.3 Kasutamine



HOIATUS!

Vigastuse, põletuse, elektrilöögi või plahvatuse oht!

- See seade on ette nähtud ainult koduseks (siseruumides) kasutamiseks.

- Ärge muutke seadme tehnilisi omadusi.
- Veenduge, et ventilatsiooniavad pole kinni.
- Ärge jätke töötavat seadet järelvalveta.
- Deaktiveerige seade iga kord pärast kasutamist.
- Olge seadme töötamise ajal ukse avamisega ettevaatlik. Kuum õhk võib vabaneda.
- Ärge kasutage seadet märgade kätega ega veega kokku puutudes.
- Ärge avaldage avatud uksele survet.
- Ärge kasutage seadet töö- ega hoiupinnana.
- Avage seadme uks ettevaatlikult. Koostisosade kasutamine koos alkoholiga võib tekitada alkoholi ja õhu segu.
- Ärge laske ukse avamisel sädemetel ega lahtisel leegil seadmega kokku puutuda.
- Ärge pange tuleohtlikke või tuleohtliku ainega märgunud esemeid seadmesse, selle lähedusse ega peale.



HOIATUS!

Seadme vigastamise või kahjustamise oht!

- Emailihi kahjustamise või värvimuutuse ärahoidmiseks:
 - ärge pange ahjunõusid ega muid esemeid otse seadme põhjale.
 - ärge asetage alumiiniumfooliumit vahetult seadme sisemuse põhjale.
 - ärge pange vett vahetult kuuma seadmesse.
 - ärge hoidke pärast küpsetamise lõpetamist seadmes niiskeid nõusid ja toitu.
 - olge lisavarustuse eemaldamisel või paigaldamisel ettevaatlik.
- Emaili või roostevaba terase värvi muutumine ei mõjuta seadme tööd kuidagi.
- Mahlasemate kookide puhul kasutage sügavat vormi. Puuviljamahlad tekitavad plekke, mis võivad olla püsivad.
- See seade on ette nähtud ainult toidu valmistamiseks. Seda ei tohi kasutada muudel eesmärkidel, näiteks ruumi soojendamiseks.
- Küpsetage alati suletud ahjuuksega.
- Kui seade paigaldatakse kööginõõbli paneeli (nt ukse) taha, siis jälgige, et seadme töötamise ajal oleks uks alati lahti. Vastasel korral võib kinnise mööblipaneeli taha kogunev niiskus kahjustada nii seadet, mööblit kui ka põrandat. Ärge sulgege paneeli või ust, enne kui seade pole pärast kasutamist täielikult maha jahtunud.

2.4 Puhastus ja hooldus



HOIATUS!

Vigastuse, tulekahju või seadme kahjustamise oht!

- Enne hooldust lülitage seade välja ja ühendage toitepistik pistikupesast lahti.
- Veenduge, et seade on maha jahtunud. Klaaspaneelid võivad puruneda.
- Kui ukse klaaspaneeli tekib mõra, tuleb see kohe välja vahetada. Pöörduge volitatud hoolduskeskusse.
- Olge ukse seadme küljest eemaldamisel ettevaatlik. Uks on raske!
- Puhastage seadet regulaarselt, et vältida pinnamaterjali kahjustumist.
- Puhastage seadet pehme niiske lapiga. Kasutage ainult neutraalseid pesuaineid. Ärge kasutage abrasiivseid tooteid, küürimisšvamme, lahusteid ega metallist esemeid.
- Ahjupihusti kasutamisel järgige pakendil olevaid ohutusjuhiseid.

2.5 Pürolüüspuhastamine



HOIATUS!

Pürolüütilise režiimiga kaasneb vigastusohu / tuleohu / keemiliste heitmete (aurud) eraldumine.

- Enne pürolüütilise isepuhastus- või esimese kasutamise läbiviimist eemaldage ahjuõõnsusest:
 - kõik toidujäätmed, õli ja rasvapritsmed või -jäädid.
 - kõik lahtivõetavad osad (sealhulgas ahjurestid, külgsiinid jm ahju juurde kuuluvad esemed), eriti aga teflonpannid, potid, plaadid, söögiriistad jne.
- Lugege hoolikalt pürolüüspuhastamise kohta käivaid juhiseid.
- Hoidke väikesed pürolüütilise puhastamise ajal seadme eemal. Seade läheb väga kuumaks ja kuum õhk väljub eesmistest jahutusavadest.
- Pürolüütiline puhastus on kõrge temperatuuri juures läbiviidav toiming, mille puhul võivad küpsetusjääkidest ja ahju materjalidest eralduda aurud. Seetõttu on soovitatav teha järgmist:
 - pürolüütilise puhastamise ajal ja pärast seda tuulutage ruumi hoolikalt.
 - esmakordsel maksimaalse temperatuuri kasutamisel ja pärast seda tuleb ruumi korralikult tuulutada.
- Erinevalt inimestest võivad mõned linnud ja roomajad pürolüütilise puhastuse ajal ahjust eralduvate aurude suhtes väga tundlikud olla.
 - Viige kõik lemmikloomad (eriti linnud) pürolüüspuhastamise ajaks ning esmakordse maksimumtemperatuuriga kasutamise ajal ja pärast seda seadme lähedusest eemale hästi tuulutatud kohta.
- Ka väikesed lemmikloomad võivad pürolüütilise puhastuse ajal ahjude läheduses tekkivate temperatuurikõikumiste suhtes üsna tundlikud olla.
- Teflonkattega potid, pannid, küpsetusplaadid või muud köögiriistad võivad pürolüütilise puhastuse ajal kasutatava kõrge temperatuuri tõttu kahjustuda; samuti võib neist selle käigus eralduda kahjulikke aineid.
- Ülal kirjeldatud aurud, mis pürolüütilistest ahjudest või küpsetusjääkidest eralduvad, ei ole inimestele, sealhulgas väikestele ega haigusi põdevatele inimestele ohtlikud.

2.6 Sisevalgustus



HOIATUS!

Elektrilöögi oht!

- Teave selles seadmes olevate lampide ja eraldi müüdvate varulampide kohta: Need lambid taluvad ka koduste majapidamiseseadmete äärmuslikumaid tingimusi, näiteks temperatuuri, vibratsiooni, niiskust või on mõeldud edastama info seadme tööoleku kohta. Need pole mõeldud kasutamiseks muudes rakendustes ega sobi ruumide valgustamiseks.
- Kasutage ainult samasuguste näitajatega lampe .

2.7 Hooldus

- Seadme parandamiseks võtke ühendust volitatud teeninduskeskusega.
- Kasutage ainult originaalvaruosi.

2.8 Kõrvaldamine



HOIATUS!

Lämbumis- või vigastusohu!

- Eemaldage seade vooluvõrgust.
- Lõigake elektrijuhe seadme lähedalt läbi ja visake ära.
- Eemaldage uksekäepide, et vältida laste või lemmikloomade seadmesse lõksujäämist.

3. TOOTE KIRJELDUS

3.1 Üldine ülevaade

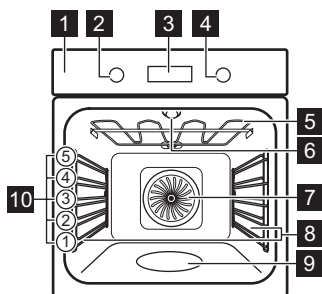

- 1** Juhtpaneel
- 2** Küpsetusrežiimide nupp
- 3** Ekraan
- 4** Juhtnupp
- 5** Kuumutuselement
- 6** Lamp
- 7** Ventilaator
- 8** Riiulitugi, eemaldatav
- 9** Riiuli asendid
- 10** Ahjuõõnsus

3.2 Lisatarvikud

Traatrest

Küpsetusnõudele, koogivormidele, praadidele.

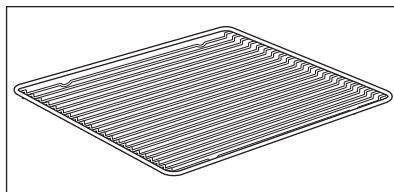

AHJU SISSE- JA VÄLJALÜLITAMINE

Küpsetusplaat

Kookide ja küpsiste jaoks.

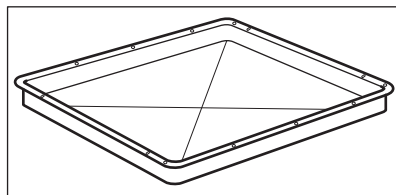

Grill-/küpsetuspann

Küpsetamiseks ja röstimiseks või pannina rasva kogumiseks.

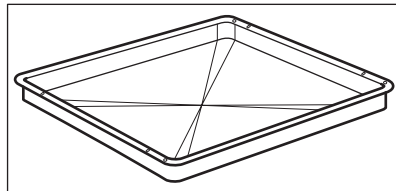

Teleskoopsiinid

Küpsetusplaatide ja traatrestide hõlpsamaks sisestamiseks ja eemaldamiseks.

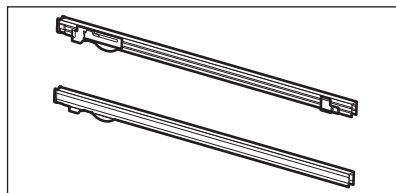







4. AHJU SISSE- JA VÄLJALÜLITAMINE



4.1 Sisselükatavad nupud







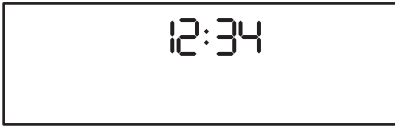

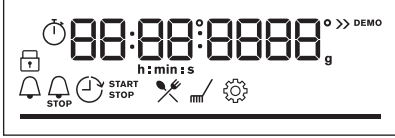
Seadme kasutamiseks vajutage nuppu. Nupp tuleb välja.

4.2 Juhtpaneel

Juhtpaneeli sensorväljad					Vajutage	Pöörake nuppu
 Taimer	 Kiirkuumus	 Sisevalgustus	 Lock	OK		
Valige küpsetusrežiim, et ahi sisse lülitada.						
Keerake küpsetusrežiimide nupp väljas-asendisse, et ahi välja lülitada.						

ENNE ESIMEST KASUTAMIST

	<p>Kui küpsetusrežiimide nupp on väljas-asendis, läheb ekraan ooterežiimi.</p>
	<p>Toiduvalmistamise ajal näitab ekraan seatud temperatuuri, kellaega ja teisi saadaolevaid funktsioone.</p>
	<p>Ekraan maksimaalse valitud funktsioonide hulgaga.</p>

Ekraani indikaatorid				
 Lukk	 Juhendatud küpsetamine	 Puhastamine	 Seaded	 Kiirkuumus
Taimeri indikaatorid:		 STOP		

<p>Edenemisriba – temperatuuri või aja jaoks.</p>	
---	---





<p>Auruküpsetuse indikaator</p>	
---------------------------------	---

5. ENNE ESIMEST KASUTAMIST





	<p>HOIATUS! Vt ohutust käsitlevaid peatükke.</p>
--	---

IGAPÄEVANE KASUTAMINE

5.1 Esmane puhastamine

Enne esimest kasutuskorda puhastage tühi ahi ja seadke aeg:			
			 0:00 Seadke kella-aeg. Vajutage nuppu OK.

5.2 Algne eelkuumutamine

 Eelkuumutage ahju enne esimest kasutamist.	
1. samm	Eemaldage ahjust kõik tarvikud ja eemaldatavad restitoided.
2. samm	Valige maksimumtemperatuur funktsioonile:  . Laske ahjul 1 h töötada.
3. samm	Valige maksimumtemperatuur funktsioonile:  . Laske ahjul 15 min töötada.
 Eelkuumutuse ajal võib ahjust tulla lõhna ja suitsu. Tuulutage ruumi pärast seda toimingut.	



6. IGAPÄEVANE KASUTAMINE





HOIATUS!

Vt ohutust käsitlevaid peatükke.

6.1 Kuidas seadistada: Küpsetusrežiimid

Alustage küpsetamist	
1. samm	2. samm
 	 °C

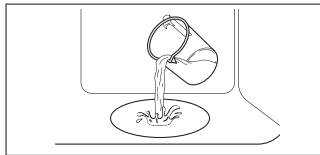
Alustage küpsetamist	
Seadke küpsetusrežiim	Seadke temperatuur.

Auruküpsetus			
Veenduge, et ahi on jahtunud.			
1. samm	2. samm	3. samm	4. samm
			Niiskuse tekitamiseks eelkuumutage tühja ahju 10 minutit. Pange toit ahju.
Kallake ahjuõõnsuse süvendisse kraanivett.	Seadke aurukuumutuse funktsioon.	Seadke temperatuur.	
<p>i Ahjuõõnsuse süvendi maksimaalne maht on 250 ml. Küpsetamise ajal või siis, kui ahi on veel kuum, ei tohi ahjuõõnsuse süvendisse vett valada.</p>			









Kui auruküpsetus lõpeb:		
1. samm	2. samm	3. samm
Keerake küpsetusrežiimide nupp väljas-asendisse, et ahi välja lülitada.	Avage ettevaatlikult uks. Eralduv aur võib põhjustada nahapõletust.	Veenduge, et ahi on jahtunud. Eemaldage ahjuõõnsuse süvendist sinna jäänud vesi.

6.2 Küpsetusrežiimid

Tavalised küpsetusrežiimid

Küpsetusrežiim	Kasutamine
 Pöördõhk	Küpsetamiseks korraka kuni kolmel tasandil ja toidu kuivatamiseks. Seadke temperatuur 20 – 40 °C madalamaks kui funktsiooniga Ülemine + alumine kuumutus.

IGAPÄEVANE KASUTAMINE

Küpsetusrežiim	Kasutamine
 Ülemine + alumine kuumutus	Ühel ahjutasandil küpsetamiseks ja röstimiseks.
 SteamBake	Niiskuse lisamiseks küpsetamise ajal. Õige värvi ja krõbeda kooriku saavutamiseks. Toidu soojendamisel mahlasuse lisamiseks. Puu- ja köögiviljade säilitamiseks.
 Pitsa funktsioon	Pitsa küpsetamiseks. Intensiivseks pruunistamiseks ja krõbeda põhja saavutamiseks.
 Alumine kuumutus	Krõbeda põhjaga kookide küpsetamiseks ja toidu hoidistamiseks.
 Külmutatud toiduained	Kiirtoidu (nt friikartulite, kartuliviilude, kevadrullide) krõbestamiseks.
 Niiske küpsetus pöördõhuga	Funktsioon küpsetamise ajal energia säästmiseks. Selle funktsiooni kasutamisel võib ahju sisemine temperatuur erineda valitud temperatuurist. Kasutatakse jääkuumust. Kuumutusvõimsus võib väheneda. Lisateavet leiata jaotisest "Igapäevane kasutamine", Märkused: Niiske küpsetus pöördõhuga.
 Grill	Õhemate toidupalade grillimiseks ja leiva röstimiseks.
 Turbogrill	Suurte kondiga liha- või linnulihatükkide röstimiseks ühel ahjutasandil. Gratineerimiseks ja pruunistamiseks.
 Menüü	Menüüsse sisenemiseks: Juhendatud küpsetamine, Puhastamine, Seaded.

6.3 Märkused: Niiske küpsetus pöördõhuga

Seda funktsiooni kasutati energiaklassi ja ökodisaini nõuete järgimiseks vastavalt määrustele EL 65/2014 ja EL 66/2014. Testid vastavalt standardile EN 60350-1.





Ahjuuks peab küpsetamise ajal olema suletud, et vältida kasutatava funktsiooni katkestamist ja tagada ahju töötamine võimalikult suure energiatõhususega.

Kasutades seda funktsiooni, lülitub lamp 30 sekundi pärast automaatselt välja.



Toiduvalmistamisjuhised leiate jaotisest "Nõuanded ja näpunäited", Niiske küpsetus pöördõhuga. Üldiseid energiasäästunõuandeid leiate jaotisest „Energiatõhusus“ alajaotisest Energiasääst.

6.4 Kuidas seadistada: Juhendatud küpsetamine

Iga selles alammenüüs oleva toidu juurde kuulub soovituslik funktsioon ja temperatuur. Saate reguleerida aega ja temperatuuri küpsetamise ajal.

Juhendatud küpsetamine – kasutage seda toidu kiireks valmistamiseks vaikesätetega:			
1. samm	2. samm	3. samm	4. samm
			
Sisenege menüüsse.	Valige Juhendatud küpsetamine. Vajutage OK.	Valige toit. Vajutage nuppu OK.	Sisestage toit ahju. Kinnitage sätted.

6.5 Juhendatud küpsetamine retseptidega













Selgitus	
	Vee kogus aurufunktsiooni jaoks.
	Enne küpsetamist eelkuumutage ahju.
	Riuli tasand.

Kui funktsioon lõpeb, kontrollige, kas toit on valmis.

	Toit	Kaal	Riuli tasand/tarvik	Kestus
Veiseliha 				

IGAPÄEVANE KASUTAMINE

	Toit	Kaal	Riili tasand/tarvik	Kestus
P1	Rostbiif, väheküps	1 – 1,5 kg; 4 – 5 cm pak-sused tükid	☐ 2; küpsetusplaat Praadige liha paar minutit kuumal pannil. Sisestage see ahju.	40 min
P2	Rostbiif, poolküps			50 min
P3	Rostbiif, täisküps			60 min
P4	Steik, poolküps	180 – 220 g tükid; 3 cm paksused viilud	☐☐ 3; toidu röstimine traatrestil Praadige liha paar minutit kuumal pannil. Sisestage see ahju.	15 min
P5	Veiseliha rostiif / hautatud veiseliha (ribiliha, sisetükk, läbikasvanud)	1,5 – 2 kg	☐ 2; toidu röstimine traatrestil Praadige liha paar minutit kuumal pannil. Lisage vedelikku. Sisestage see ahju.	120 min
P6	Rostbiif, väheküps (aeglane küpsetamine)	1 – 1,5 kg; 4 – 5 cm pak-sused tükid	☐ 2; küpsetusplaat Kasutage oma lemmikvürtse või lihsalt soola ja värsket jahvatatud pipart. Praadige liha paar minutit kuumal pannil. Sisestage see ahju.	75 min
P7	Rostbiif, poolküps (aeglane küpsetamine)			85 min
P8	Rostbiif, täisküps (aeglane küpsetamine)			130 min
P9	Filee, väheküps LTC* (aeglane küpsetamine)	0,5 – 1,5 kg; 5 – 6 cm paksused tükid	☐ 2; küpsetusplaat Kasutage oma lemmikvürtse või lihsalt soola ja värsket jahvatatud pipart. Praadige liha paar minutit kuumal pannil. Sisestage see ahju.	75 min
P10	Filee, poolküps (aeglane küpsetamine)			90 min
P11	Filee, täisküps (aeglane küpsetamine)			120 min

	Toit	Kaal	Riuli tasand/tarvik	Kestus
Vasikaliha 				
P12	Röstitud vasikaliha (nt abatükk)	0,8 – 1,5 kg; 4 cm paksused tükid	 2 ; toidu röstimine traatrestil Kasutage oma lemmikvürtse. Lisage vedelikku. Röstpraad, kaetud.	80 min
Sealiha 				
P13	Röstitud sea-kael või abatükk	1,5 – 2 kg	 2 ; toidu röstimine traatrestil Pöörake liha poole küpsetusaja möödudes.	120 min
P14	Rebitud sealiha LTC	1,5 – 2 kg	 2 ; küpsetusplaat Kasutage oma lemmikvürtse. Pöörake liha poole küpsetusaja möödudes, et saavutada ühtlane pruunistumine.	215 min
P15	Seljatükk, värske	1 – 1,5 kg; 5 – 6 cm paksused viilud	 2 ; toidu röstimine traatrestil Kasutage oma lemmikvürtse.	55 min
P16	Searibid	2 – 3 kg; kasutage tooreid, 2 – 3 cm paksuseid searibid	 3 ; ahjupann Lisage vedelikku, et katta nõu põhi. Pöörake liha poole küpsetusaja möödudes.	90 min
Lammas 				
P17	Tallekoot, luudega	1,5 – 2 kg; 7 – 9 cm paksused tükid	 2 ; toidu röstimine küpsetusplaadil Lisage vedelikku. Pöörake liha poole küpsetusaja möödudes.	130 min
Linnuliha 				
P18	Kana, terve	1 – 1,5 kg; värske	 2 ;  200 ml; vormiroog küpsetusplaadil Kasutage oma lemmikvürtse. Pöörake kana poole küpsetusaja möödudes, et saavutada ühtlane pruunistumine.	60 min















IGAPÄEVANE KASUTAMINE

	Toit	Kaal	Riili tasand/tarvik	Kestus
P19	Pool kana	0,5 – 0,8 kg	3 ; küpsetusplaat Kasutage oma lemmikvürtse.	40 min
P20	Kanarind	180 – 200 g tükid	2; vormiroog traatrestil Kasutage oma lemmikvürtse. Praadige liha paar minutit kuuma pannil.	25 min
P21	Kanakoivad, värsked	-	3; küpsetusplaat Kui marineerisite kõigepealt kanakoivad, seadke temperatuur madalamaks ja küpsetage neid kauem.	30 min
P22	Part, terve	2 – 3 kg	2; toidu röstimine traatrestil Kasutage oma lemmikvürtse. Pange liha röstimispannile. Pöörake parti poole küpsetusaja möödudes.	100 min
P23	Hani, terve	4 – 5 kg	2; ahjupann Kasutage oma lemmikvürtse. Pange liha sügavale küpsetusplaadile. Pöörake hane poole küpsetusaja möödudes.	110 min
Muu				
P24	Pikkpoiss	1 kg	2; traatrest Kasutage oma lemmikvürtse.	60 min
Kala				
P25	Terve kala, grillitud	0,5 – 1 kg kala kohta	2 ; küpsetusplaat Täitke kala võiga ning kasuta oma lemmikvürtse ja -ürte.	30 min
P26	Kalafilee	-	3; vormiroog traatrestil Kasutage oma lemmikvürtse.	20 min
Magusad küpsetised/magustoidud				
P27	Juustukook	-	2; 28 cm lahtikäiv metallvorm traatrestil	90 min

IGAPÄEVANE KASUTAMINE





	Toit	Kaal	Riuli tasand/tarvik	Kestus
P28	Õunakook	-	2; 100 – 150 ml; küpsetusplaat	60 min
P29	Õunakook	-	2; koogivorm traatrestil	40 min
P30	Õunapirukas	-	2; 100 – 150 ml; 22 cm koogivorm traatrestil	60 min
P31	Šokolaadi-koogikesed	2kg	3; ahjupann	30 min
P32	Šokolaadi-muffinid	-	2; 100 – 150 ml; muffinialus traatrestil	30 min
P33	Pätsikook	-	2; leivapann traatrestil	50 min
Köögiviljatoidud/lisandid				
P34	Küpsetatud kartulid	1 kg	2; küpsetusplaat Pange terved koorimata kartulid küpsetusplaadile.	50 min
P35	Viilud	1 kg	3; küpsetuspaberiga vooderdatud küpsetusplaat Kasutage oma lemmikvürtse. Lõigake kartulid tükkideks.	35 min
P36	Grillitud köögiviljasegu	1 – 1,5 kg	3; küpsetuspaberiga vooderdatud küpsetusplaat Kasutage oma lemmikvürtse. Lõigake köögiviljad tükkideks.	30 min
P37	Kroketid, külmutatud	0,5 kg	3; küpsetusplaat	25 min
P38	Kartulipallikesed, külmutatud	0,75 kg	3; küpsetusplaat	25 min
Gratäänid, leib ja pitsa				

KELLA FUNKTSIOONID



	Toit	Kaal	Riili tasand/tarvik	Kestus
P39	Lasanje/nuud-livorm	1 – 1,5 kg	 2; vormiroog traatrestil	45 min
P40	Kartuligratään	1 – 1,5 kg	 1; vormiroog traatrestil	50 min
P41	Värske pitsa, õhuke	-	  2;  100 ml; küpsetuspaberiga vooderdatud küpsetusplaat	15 min
P42	Värske pitsa, paks	-	  2;  100 ml; küpsetuspaberiga vooderdatud küpsetusplaat	25 min
P43	Quiche	-	 2; küpsetusvorm traatrestil	45 min
P44	Baguette/ ciabatta/sai	0,8 kg	  3;  150 ml; küpsetuspaberiga vooderdatud küpsetusplaat Saia küpsetamiseks on vaja rohkem aega.	30 min
P45	Täisteraleib/ rukkileib/täisteraline must leib leivapannil	1 kg	  2;  150 ml; küpsetuspaberiga vooderdatud liküpsetusplaat/ traatrest	45 min







7. KELLA FUNKTSIOONID







7.1 Kella funktsioonid

Kella funktsioon	Kasutamine
	Minutilugeja. Kui taimer jõuab lõpule, kõlab signaal.
	Küpsetusaeg. Kui taimer jõuab lõpule, kõlab signaal ja küpsetusrežiim lõpetab töö.
	Viivitusae. Algusaja ja/või küpsetusaja lõpu edasilükkamiseks.
	Uptimer. Maksimumaeg on 23 h 59 min. See funktsioon ei mõjuta ahju tööd. Uptimer sisse ja välja lülitamiseks valige: Menüü, Seaded.











7.2 Kuidas seadistada: Kella funktsioonid

Kuidas seadistada: Kellaeg		
1. samm	2. samm	3. samm
		
Kellaaja muutmiseks sisenege menüüsse ja valige Sätted, Kellaeg.	Seadke kell.	Vajutage: OK.

Kuidas seadistada: Minutilugeja			
1. samm	Näidikul kuvatakse: 0:00 	2. samm	3. samm
			
Vajutage: 	Seadke Minutilugeja	Vajutage: OK.	
 Taimer alustab kohe pöördloendust.			

Kuidas seadistada: Kõpsetusaeg				
1. samm	2. samm	Näidikul kuvatakse: 0:00  STOP	3. samm	4. samm
				
Valige kõpsetusrežiim ja seadke temperatuur.	Vajutage korduvalt: 	Seadke kõpsetusaeg.	Vajutage: OK.	
 Taimer alustab kohe pöördloendust.				

KUIDAS KASUTADA: TARVIKUD

Kuidas seadistada: Viivitusaeg							
1. samm	2. samm		3. samm	4. samm		5. samm	6. samm
		Ekraanil kuvatakse: kella-aeg 			Näidikul kuvatakse: --- 		
Seadke küpsetusrežiim.	Vajutage korduvalt: 		START	Seadke algusaeg.		Vajutage: OK	STOPP
 Taimer alustab kindlal algusajal pöördloendust.							

8. KUIDAS KASUTADA: TARVIKUD

8.1 Tarvikute sisestamine

Väike ülaosas asuv sälg suurendab turvalisust. Need sälgud aitavad ära hoida ka kaldumist. Kõrged servad aitavad ära hoida ahjunõude restilt mahalibisemist.

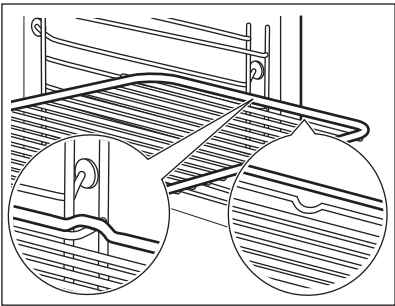
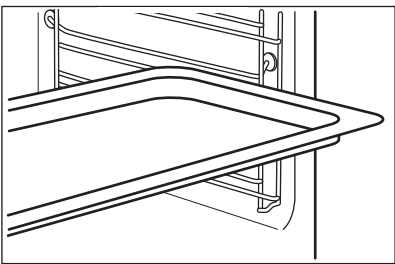
<p>Traatrest: Lükake rest restitoe juhtsoontele .</p>	
<p>Küpsetusplaat /Sügav pann: Lükake ahjuresst riuliraami juhtsoonte vahele.</p>	

Traatrest, Küpsetusplaat /Sügav pann:

Lükake plaat restitugede juhikutesse ja traatrest selle kohal olevatesse juhikutesse.

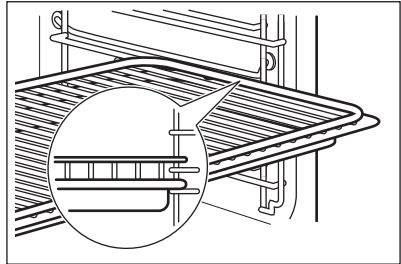

9. LISAFUNKTSIOONID

9.1 Lukk

See funktsioon hoiab ära küpsetusrežiimi tahtmatu muutmise.

Lülitage see sisse, kui ahi töötab – seatud küpsetamine jätkub, juhtpaneel on lukustatud.
Lülitage see sisse, kui ahi on väljas – ahju ei saa sisse lülitada, juhtpaneel on lukustatud.





 – funktsiooni sisse lülitamiseks vajutage ja hoidke. Kostab signaal.

 – funktsiooni välja lülitamiseks vajutage ja hoidke.

 3 x  – vilgub, kui lukustus on sisse lülitatud.

9.2 Automaatne väljalülitus

Turvakaalutlustel lülitub ahi mõne aja pärast välja, kui küpsetusrežiim töötab ja te ühtegi sätet ei muuda.

 (°C)	 (h)
30 - 115	12.5
120 - 195	8.5
200 - 245	5.5
250 – maksimum	3

Automaatne väljalülitus ei tööta funktsioonidega: Sisevalgustus, Viivitusae.

VIHJEID JA NÄPUNÄITEID



9.3 Jahutusventilaator

Ahju töö ajal lülitub jahutusventilaator automaatselt sisse, et hoida seadme pinnad jahedana. Ahju välja lülitades võib jahutusventilaator jätkata tööd seni, kuni ahi on maha jahtunud.

10. VIHJEID JA NÄPUNÄITEID



10.1 Niiske küpsetus pöördõhuga

Parimate tulemuste saamiseks järgige alltoodud tabelis olevaid soovitusi. Kasutage kolmandat riulitasandit.

	 (°C)	 (min)
Pastavorm	200 - 220	45 - 55
Kartuligratään	180 - 200	70 - 85
Moussaka	170 - 190	70 - 95
Lasanje	180 - 200	75 - 90
Cannelloni	180 - 200	70 - 85
Saiavorm	190 - 200	55 - 70
Riisipuding	170 - 190	45 - 60
Õunakook biskviitaignast (ümmargune koogivorm)	160 - 170	70 - 80
Sai	190 - 200	55 - 70

10.2 Niiske küpsetus pöördõhuga - soovitatavad tarvikud

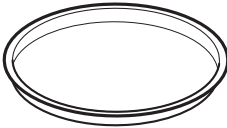
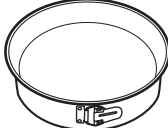
Kasutage tumedaid ja mittepeegeldava pinnaga nõusid. Need tõmbavad kuumust paremini sisse kui heledad ja peegelduvad pinnad.







 Pitsapann	 Küpsetusnõu	 Portsjoninõu	 Pirukavorm
--	---	--	---







Tume, mittepeegelduv 28 cm läbimõõduga	Tume, mittepeegelduv 26 cm läbimõõduga	Keraamika 8 cm läbi- mõõduga, 5 cm kõrged	Tume, mittepeegelduv 28 cm läbimõõduga
---	---	--	---

10.3 Küpsetustabelid testimisasutustele

Teave testimisasutustele

Testid vastavalt standardile: EN 60350, IEC 60350.

 KÜPSETAMINE ÜHEL TASANDIL. Küpsetamine vormides				
		 (°C)	 (min)	
Rasvatu keeks	Pöördõhk	140 - 150	35 - 50	2
Rasvatu keeks	Ülemine + alumine kuumutus	160	35 - 50	2
Õunakook, 2 vormis Ø 20 cm	Pöördõhk	160	60 - 90	2
Õunakook, 2 vormis Ø 20 cm	Ülemine + alumine kuumutus	180	70 - 90	1

 KÜPSETAMINE ÜHEL TASANDIL. Küpsised				
 Kasutage kolmandat tasandit.				
		 (°C)	 (min)	
Liivaküpsised / Taignaribad	Pöördõhk	140	25 - 40	
Liivaküpsised / Taignaribad, tühja ahju eelkuumutamine	Ülemine + alumine kuumutus	160	20 - 30	





VIHJEID JA NÄPUNÄITEID



KÜPSETAMINE ÜHEL TASANDIL. Küpsised







Kasutage kolmandat tasandit.

		 (°C)	 (min)
Väikesed koogid, 20 tk plaadil, tühja ahju eelkuu- mutamine	Pöördõhk	150	20 - 35
Väikesed koogid, 20 tk plaadil, tühja ahju eelkuu- mutamine	Ülemine + alumine kuu- mutus	170	20 - 30



KÜPSETAMINE MITMEL TASANDIL. Küpsised

		 (°C)	 (min)	
Liivaküpsised / Taignari- bad	Pöördõhk	140	25 - 45	1 / 4
Väikesed koogid, 20 tk plaadil, tühja ahju eelkuu- mutamine	Pöördõhk	150	23 - 40	1 / 4
Rasvatu keeks	Pöördõhk	160	35 - 50	1 / 4



GRILLIMINE



Eelsoojendage tühja ahju 5 minutit.



Grill maksimaalse temperatuuriseadega.



(min)



Röstleib/-sai

Grill

1 - 3

5

Biifsteek, pöörake poole valmistusaja möödudes

Grill

24 - 30

4

11. PUHASTUS JA HOOLDUS



HOIATUS!

Vt ohutust käsitlevaid peatükke.

11.1 Juhised puhastamiseks



Puhastusvahendid

Puhastage ahju esikülge pehme lapi, sooja vee ning pehmetoimelise pesuvahendiga.

Metallpindadel kasutage puhastusvahendi lahust.

Plekkide eemaldamiseks kasutage pehmetoimelist puhastusvahendit.



Igapäevane kasutamine

Puhastage ahi pärast igakordset kasutamist. Toidujääkide kogunemine võib kaasa tuua süttimise.

Ärge jätke toitu ahju kauemaks seisma kui 20 minutit. Kuivatage pärast kasutamist ahju sisemust pehme lapiga.



Tarvikud

Pärast iga kasutuskorda puhastage kõik ahjutarvikud ja laske neil kuivada. Kasutage pehmet lappi sooja vee ja õrna puhastusvahendiga. Ärge peske tarvikuid nõudepesumasinas.

Ärge puhastage mittenakkuva pinnaga tarvikuid abrasiivse puhastusvahendi või teravate esemetega.

11.2 Kuidas puhastada: Veēsüvend

Puhastage ahjuõõnsuse süvendit, et eemaldada lubjasettejäädid pärast auruküpsetust.

1. samm	2. samm	3. samm
Kallake 250 ml vett ahju põhjas olevasse süvendisse. Kasutage max 6%-list ilma lisanuditeta äädikat.	Laske 30 minuti jooksul äädikal lubjasettejäädid toatemperatuuril lahustada.	Puhastage ahjuõõnsus sooja vee ja lahja pesuvahendiga.
Funktsiooni seadmine: SteamBake puhastage ahju iga 5 – 10 küpsetustsükli järel.		

11.3 Kuidas eemaldada: restitoid

Ahju puhastamiseks eemaldage restitoid .

1. samm	Lülitage ahi välja ja oodake, kuni see on jahtunud.	
2. samm	Tõmmake ahjuresti tugede esiosa külgseina küljest lahti.	
3. samm	Tõmmake ahjuresti toe tagaosa külgseina küljest lahti ja eemaldage tugi.	
4. samm	Paigaldage ahjuplaadi toed tagasi vastupidises järjekorras. Teleskoopsiinide tõkked peavad olema suunatud ettepoole.	

11.4 Kuidas kasutada: Pürolüüspuhastamine

Puhastage ahi, kasutades Pürolüüspuhastamine.



HOIATUS!

Eksisteerib põletusohu.



ETTEVAATUST!

Kui samasse kapiossa on paigaldatud ka teisi seadmeid, ärge kasutage neid selle funktsiooniga samal ajal. See võib ahju kahjustada.

Enne Pürolüüspuhastamine:

Lülitage ahi välja ja oodake, kuni see on jahtunud.	Eemaldage kõik tarvikud ja eemaldatavad restitoided.	Puhastage ahjupõhja ja sisemist ukseklaasi sooja vee, pehmetoimelise nõudepesuvahendi ja pehme lapiga.
---	--	--

Pürolüüspuhastamine

1. samm	Sisenege menüüsse: Puhastamine $\text{mm}/$.	
	Funktsioon	Kestus
	C1 - Kerge puhastamine	1 h
	C2 - Tavaline puhastamine	1 h 30 min
	C3 - Põhjalik puhastamine	3 h
2. samm	OK – vajutage, et valida puhastusprogramm.	
3. samm	OK – vajutage, et alustada puhastamist.	
4. samm	Pärast puhastamist keerake küpsetusrežiimide nupp väljas-asendisse.	
<p> Puhastamise ajal ahju tuli ei põle.</p> <p>Kui ahi on jõudnud seatud temperatuurini, uks lukustub. Kuni ukse avanemiseni kuvatakse ekraanil: .</p>		

Kui puhastamine lõpeb:

Lülitage ahi välja ja oodake, kuni see on jahtunud.	Puhastage ahju sisemust pehme lapiga.	Eemaldage jäägid ahju põhjast.
---	---------------------------------------	--------------------------------

11.5 Puhastamise meeldetuletus

Ahi tuletab teile meelde, millal seda tuleb pürolüütilise funktsiooniga puhastada:	
 vilgub ekraanil 5 sekundit pärast iga toiduvalmistamisseansi.	Meeldetuletuse välja lülitamiseks sisenege Menüü ja valige Seaded, Puhastamise meeldetuletus.

11.6 Kuidas eemaldada ja paigaldada: Uks

Puhastamiseks saate ukse ja sisemised klaaspaneelid eemaldada. Klaaspaneelide arv on erinev konkreetsest mudelist.

	HOIATUS! Uks on raske.
	ETTEVAATUST! Olge klaasi ja esipaneeli servade käsitlemisel ettevaatlik. Klaas võib puruneda.

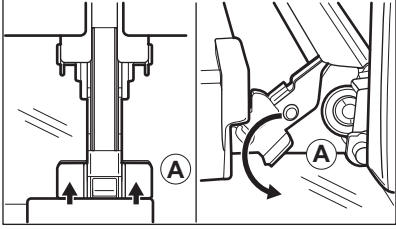
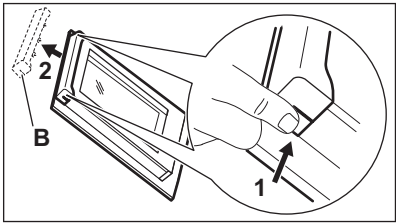
1. samm	Sulgege uks korralikult.	
2. samm	Tõstke üles ja suruge täielikult sisse kinnitushoovad (A), mis paiknevad kahel uksehingel.	
3. samm	Sulgege ahjuuks esimesse avamisasendisse (ligikaudu 70° nurga all). Hoidke ust mõlemalt poolt ja tõmmake see ülespoole suunatult ahjust eemale. Pange uks, väliskülj allpool, pehmele ja tasasele pinnale.	
4. samm	Vajutage ukse ülemises servas olevat ukselistu (B) kummaltki küljelt sissepoole, et klamberkinnitus vabastada.	
5. samm	Eemaldamiseks tõmmake ukselistu ettepoole.	
6. samm	Hoidke ukse klaaspaneeli ülaservast ühekaupa kinni ja tõmmake need, suunaga üles, juhikust välja.	

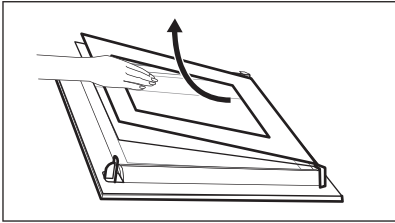
7. samm	Puhastage klaaspaneeli seebiveega. Kuivatage klaaspaneeli hoolikalt. Ärge peske klaaspaneeli nõudepesumasinas.	
8. samm	Pärast puhastamist korrake eeltoodud samme vastupidi-ses järjestuses.	
9. samm	Pange esmalt kohale väiksem paneel, seejärel suurem ja siis uks. Veenduge, et tagasipaigutatavad klaasid on õigetpidi, vastasel korral võib ukse pind üle kuumeneda.	

11.7 Kuidas asendada: lamp



HOIATUS!

Elektrilöögi oht!
Lamp võib olla kuum.

Enne lambi vahetamist:		
1. samm	2. samm	3. samm
Lülitage ahi välja. Oodake, kuni ahi on jahtunud.	Eemaldage ahi vooluvõrgust.	Pange ahju põhjale riie.

Ülemine lamp

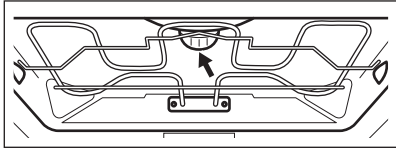
1. samm	Klaaskatte eemaldamiseks keerake seda.	
2. samm	Puhastage klaaskate.	
3. samm	Asendage lamp sobiva 300 °C taluva kuumakindla lambiga.	
4. samm	Paigaldage klaaskate.	

12. VEAOTSING



HOIATUS!

Vt ohutust käsitlevaid peatükke.

12.1 Mida teha, kui...

Tabelis loetlemata variantide puhul pöörduge volitatud teeninduskeskuse poole.



Ahi ei lülitu sisse või ei kuumene

Probleem	Kontrollige, kas:
Ahju ei saa käivitada või kasutada.	Ahi ei ole õigesti elektrivõrku ühendatud.
Ahi ei kuumene.	Väljalülitusautomaatika on deaktiveeritud.
Ahi ei kuumene.	Ahjuuks on lukustatud.
Ahi ei kuumene.	Kaitse ei ole vallandunud.
Ahi ei kuumene.	Lapselukk on välja lülitatud.



Komponendid

Probleem	Kontrollige, kas:
Lamp on välja lülitatud.	Niiske küpsetus pöördõhuga – on sisse lülitatud.
Lamp ei tööta.	Lamp on läbi põlenud.



Veakoodid

Ekraanil kuvatakse...	Kontrollige, kas:
Err C3	Ahjuuks on suletud või ukسلukk ei ole katki.
Err F102	Ahjuuks on lukustatud.
Err F102	Ukselukk ei ole katki.

**Veakoodid**

0:00

Toimus elektrikatkestus. Seadke kella-aeg.

Kui ekraanil kuvatakse veakood, mida tabelis ei leidu, lülitage kaitse välja ja sisse, et ahi taaskäivitada. Kui veakood ilmub uuesti, pöörduge volitatud teeninduskeskuse poole.

**Puhastamine****Probleem****Kontrollige, kas:**

Vesi valgub ahjuõõnsuse süvendist välja.

Ahjuõõnsuse süvendis on liiga palju vett.

12.2 Hooldusteave

Kui te ei suuda probleemile ise lahendust leida, siis võtke ühendust edasimüüja või teeninduskeskusega.

Teeninduskeskuse andmed leiate andmesildilt. Andmesilt asub ahjuõõne raami esiküljel. Ärge andmesilti ahju sisemusest eemaldage.

Soovitame märkida siia järgmised andmed:

Mudel (MOD.)

.....

Tootenumber (PNC)

.....

Seerianumber (S.N.)

.....

13. ENERGIATÕHUSUS

13.1 Tooteteave ja toote infoleht*

Tarnija nimi	AEG
Mudeli tunnus	BPB351160M 944188506 BPS351160M 944188507
Energiatõhususe indeks	81.2
Energiatõhususe klass	A+

ENERGIATÕHUSUS

Energiatarbimine standardtäituvusel, tavalises režiimis	1.09 kWh/tsükliks	
Energiatarbimine standardtäituvusel, pöördõhurežiimis	0.69 kWh/tsükliks	
Kambrite arv	1	
Soojusallikas	Elekter	
Helitugevus	71 l	
Ahju tüüp	Sisseehitatud ahi	
Mass	BPB351160M	34.0 kg
	BPS351160M	34.0 kg

* Euroopa Liidu puhul vastavalt EL-i määrustele 65/2014 ja 66/2014.

Valgevene Vabariigi puhul vastavalt standardile STB 2478-2017, lisa G; STB 2477-2017, lisad A ja B.

Ukraina puhul vastavalt dokumendile 568/32020.

Energiatõhususe klass ei kehti Venemaa puhul.

EN 60350-1 – Kodumajapidamises kasutatavad elektrilised toiduvalmistusseadmed – Osa 1: Pliidid, ahjud, auruahjud ja grillid. – Toimivuse mõõtemetodid.

13.2 Energia kokkuhoid



Seadmel on funktsioonid, mis aitavad säästa energiat igapäevasel toiduvalmistamisel.

Veenduge, et ahjuuks on ahju töötamise ajal suletud. Ärge küpsetamise ajal ahjuust liiga tihti avage. Jälgige, et uksetihend oleks puhas ja korralikult omal kohal.

Energia kokkuhoiu tagamiseks kasutage metallnõusid.

Kui võimalik, ärge eelkuumutage ahju enne küpsetamist.

Kui valmistate järjest mitu küpsetist, püüdke need ahju panna võimalikult lühikeste vahedega.

Küpsetamine pöördõhuga

Võimalusel kasutage energia kokkuhoiuks pöördõhuga küpsetusrežiime.

Jääkkuumus

Ventilaator ja valgusti jäävad sisselülitatuks. Ahju väljalülitamisel kuvatakse ekraanil jääkkuumuse näit. Seda soojust saab kasutada toidu soojashoidmiseks.

Kui küpsetusaeg on pikem kui 30 minutit, vähendage vähemalt 3–10 minutit enne küpsetusaja lõppu ahju temperatuuri. Ahju sees oleva jääkkuumuse abil küpsemine jätkub.

Muude toitade soojendamiseks kasutage jääkkuumust.

Muude toitade soojendamiseks kasutage jääkkuumust.

Toidu soojashoidmine

Jääkkuumuse kasutamiseks ja toidu soojashoidmiseks valige madalaim võimalik temperatuur.

Ekraanile ilmub jääkkuumuse indikaator või temperatuurinäit.

Küpsetamine väljalülitatud valgustiga

Lülitage küpsetamise ajaks valgusti välja. Pange see põlema ainult siis, kui vaja.

Niiske küpsetus pöördõhuga



Funktsioon, mis säästab küpsetamise ajal energiat.







Selle funktsiooni kasutamisel lülitub lamp automaatselt 30 sekundi pärast välja. Lambi võib soovi korral sisse lülitada, kuid see vähendab eeldatavat energiakokkuhoidu.

14. MENÜÜ STRUKTUUR

14.1 Menüü

	 – valige, et sisestada Menüü.
---	---

Menüü struktuur		
Juhendatud küpsetamine 	Puhastamine 	Seaded 



1. samm	2. samm	3. samm	4. samm	5. samm
 	 OK	 O1 - O11	 OK	
Valige Menüü, Seaded.	Kinnitage sätted.	Valige säte.	Kinnitage sätted.	Reguleerige väärtust ja vajutage nuppu OK.

Seaded					
O1	Kellaaeg	Muuda	O2	Ekraani heledus	1 - 5
O3	Nuputoonid	1 - Piiks 2 - Klõps 3 - Heli väljas	O4	Helitugevus	1 - 4
O5	Uptimer	Sees/Väljas	O6	Sisevalgustus	Sees/Väljas
O7	Kiirkuumutus	Sees/Väljas	O8	Puhastamise meeldetuletus	Sees/Väljas

MENÜÜ STRUKTUUR

Seaded					
O9	Demorežiim	Aktiveerimis- kood: 2468	O10	Tarkvaraversioon	Kontrollida
O11	Taasta tehaseseaded	Jah/ei			

15. JÄÄTMEKÄITLUS

Sümboliga  tähistatud materjalid võib ringlusse suunata. Selleks viige pakendid vastavatesse konteineritesse. Aidake hoida keskkonda ja inimeste tervist ja suunake elektri- ja elektroonilised jäätmed ringlusse. Ärge visake sümboliga  tähistatud seadmeid muude majapidamisjäätmete hulka. Viige seade kohalikku ringluspunkti või pöörduge abi saamiseks kohalikku omavalitsusse.

ΓΙΑ ΤΕΛΕΙΑ ΑΠΟΤΕΛΕΣΜΑΤΑ

Ευχαριστούμε που επιλέξατε αυτό το προϊόν AEG. Το έχουμε δημιουργήσει για να σας παρέχουμε τέλεια απόδοση για πολλά χρόνια, με καινοτόμες τεχνολογίες που βοηθούν να απλοποιείτε τη ζωή σας – δυνατότητες που μπορεί να μην βρείτε σε συνηθισμένες συσκευές. Σας παρακαλούμε να αφιερώσετε λίγα λεπτά και να διαβάσετε τις οδηγίες, ώστε να διασφαλίσετε την καλύτερη δυνατή χρήση της συσκευής σας.

Επισκεφθείτε τον ιστότοπό μας για να:



Βρείτε υποδείξεις χρήσης, φυλλάδια, συμβουλές για την επίλυση προβλημάτων, πληροφορίες σέρβις και επισκευής:

www.aeg.com/support



Καταχωρίστε το προϊόν σας, ώστε να έχετε καλύτερο σέρβις:

www.registreaeg.com



Αγοράστε αξεσουάρ, αναλώσιμα και γνήσια ανταλλακτικά για τη συσκευή σας:

www.aeg.com/shop



Για περισσότερες συνταγές, συμβουλές, επίλυση προβλημάτων, κάντε λήψη της εφαρμογής **My AEG Kitchen**.



ΕΞΥΠΗΡΕΤΗΣΗ ΠΕΛΑΤΩΝ ΚΑΙ ΣΕΡΒΙΣ

Χρησιμοποιείτε πάντα μόνο γνήσια ανταλλακτικά.

Όταν επικοινωνείτε με το Εξουσιοδοτημένο Κέντρο Σέρβις, βεβαιωθείτε ότι έχετε διαθέσιμα τα ακόλουθα στοιχεία: Μοντέλο, PNC, Αριθμός σειράς.

Μπορείτε να βρείτε τις πληροφορίες στην πινακίδα τεχνικών χαρακτηριστικών.

 Προειδοποίηση / Προσοχή - Πληροφορίες για την ασφάλεια

 Γενικές πληροφορίες και συμβουλές

 Πληροφορίες σχετικά με το περιβάλλον

Υπόκειται σε αλλαγές χωρίς προειδοποίηση.

ΠΕΡΙΕΧΟΜΕΝΑ

1. ΠΛΗΡΟΦΟΡΙΕΣ ΓΙΑ ΤΗΝ ΑΣΦΑΛΕΙΑ.... 182	2.5 Πυρολυτικός καθαρισμός..... 187
1.1 Ασφάλεια παιδιών και ευπαθών ατόμων..... 182	2.6 Εσωτερικός φωτισμός..... 188
1.2 Γενικές πληροφορίες για την ασφάλεια..... 183	2.7 Σέρβις..... 188
	2.8 Απώρριψη..... 188
2. ΟΔΗΓΙΕΣ ΓΙΑ ΤΗΝ ΑΣΦΑΛΕΙΑ..... 184	3. ΠΕΡΙΓΡΑΦΗ ΠΡΟΪΟΝΤΟΣ..... 188
2.1 Εγκατάσταση..... 184	3.1 Γενική επισκόπηση..... 189
2.2 Ηλεκτρική σύνδεση..... 185	3.2 Αξεσουάρ..... 189
2.3 Χρήση..... 186	
2.4 Φροντίδα και καθαρισμός..... 187	

4. ΓΙΑ ΕΝΕΡΓΟΠΟΪΗΣΗ ΚΑΙ ΑΠΕΝΕΡΓΟΠΟΪΗΣΗ ΤΟΥ ΦΟΥΡΝΟΥ.....	190
4.1 Βυθιζόμενοι διακόπτες.....	190
4.2 Πίνακας χειριστηρίων.....	190
5. ΠΡΙΝ ΤΗΝ ΠΡΩΤΗ ΧΡΉΣΗ.....	191
5.1 Αρχικός καθαρισμός.....	191
5.2 Αρχική προθέρμανση.....	192
6. ΚΑΘΗΜΕΡΙΝΉ ΧΡΉΣΗ.....	192
6.1 Τρόπος ρύθμισης: Προγράμματα θέρμανσης.....	192
6.2 Προγράμματα.....	193
6.3 Σημειώσεις σχετικά με: Υγρός Θερμός Αέρας	194
6.4 Τρόπος ρύθμισης: Μαγείρεμα με βοήθεια.....	195
6.5 Μαγείρεμα με βοήθεια με συνταγές.....	195
7. ΛΕΙΤΟΥΡΓΙΕΣ ΡΟΛΟΓΙΟΥ.....	201
7.1 Λειτουργίες ρολογιού.....	201
7.2 Τρόπος ρύθμισης: Λειτουργίες ρολογιού.....	202
8. ΤΡΟΠΟΣ ΧΡΉΣΗΣ: ΑΞΕΣΟΥΑΡ.....	203
8.1 Εισαγωγή αξεσουάρ.....	203
9. ΠΡΟΣΘΕΤΕΣ ΛΕΙΤΟΥΡΓΙΕΣ.....	204
9.1 Κλειδίωμα.....	204
9.2 Αυτόματη απενεργοποίηση.....	204
9.3 Ανεμιστήρας.....	205
10. ΥΠΟΔΕΪΞΕΙΣ ΚΑΙ ΣΥΜΒΟΥΛΕΣ.....	205
10.1 Υγρός Θερμός Αέρας	205
10.2 Υγρός Θερμός Αέρας - προτεινόμενα αξεσουάρ.....	206
10.3 Πίνακες μαγειρέματος για ινστιτούτα δοκιμών.....	206
11. ΦΡΟΝΤΙΔΑ ΚΑΙ ΚΑΘΑΡΙΣΜΑ.....	208
11.1 Σημειώσεις για τον καθαρισμό... ..	209
11.2 Τρόπος καθαρισμού: Ανάγλυφο τμήμα εσωτερικού του φούρνου.....	209
11.3 Τρόπος αφαίρεσης: Στηρίγματα σαχάρων	209
11.4 Τρόπος χρήσης: Πυρολυτικός Καθαρισμός.....	210
11.5 Υπενθύμιση Καθαρισμού.....	211
11.6 Τρόπος αφαίρεσης και τοποθέτησης: Πόρτα.....	211
11.7 Τρόπος αντικατάστασης: Λαμπτήρας.....	213
12. ΑΝΤΙΜΕΤΩΠΙΣΗ ΠΡΟΒΛΗΜΑΤΩΝ.....	213
12.1 Τι να κάνετε αν.....	213
12.2 Δεδομένα Σέρβις.....	215
13. ΕΝΕΡΓΕΙΑΚΉ ΑΠΟΔΟΣΗ.....	215
13.1 Πληροφορίες Προϊόντος και Φύλλο Πληροφοριών Προϊόντος*.....	215
13.2 Εξοικονόμηση ενέργειας.....	216
14. ΔΟΜΉ ΜΕΝΟΥ.....	217
14.1 Μενού.....	217

1. ⚠ ΠΛΗΡΟΦΟΡΪΕΣ ΓΙΑ ΤΗΝ ΑΣΦΑΛΕΙΑ

Πριν από την εγκατάσταση και τη χρήση της συσκευής, διαβάστε προσεκτικά τις παρεχόμενες οδηγίες. Ο κατασκευαστής δεν είναι υπεύθυνος για τυχόν τραυματισμούς ή ζημιές που είναι αποτέλεσμα λανθασμένης εγκατάστασης ή χρήσης. Να φυλάσσετε πάντα αυτές τις οδηγίες σε ένα ασφαλές μέρος με εύκολη πρόσβαση για μελλοντική αναφορά.

1.1 Ασφάλεια παιδιών και ευπαθών ατόμων

- Η συσκευή αυτή μπορεί να χρησιμοποιηθεί από παιδιά ηλικίας 8 ετών και άνω και από άτομα με μειωμένες

σωματικές, αισθητηριακές ή πνευματικές δυνατότητες ή έλλειψη εμπειρίας και γνώσης, εάν επιβλέπονται ή έχουν λάβει οδηγίες σχετικά με τη χρήση της συσκευής με ασφαλή τρόπο και κατανοούν τους κινδύνους που ενέχονται. Παιδιά ηλικίας μικρότερης των 8 ετών και άτομα με εκτενείς και περίπλοκες αναπηρίες πρέπει να παραμένουν μακριά από τη συσκευή, εκτός εάν επιβλέπονται συνεχώς.

- Τα παιδιά πρέπει να εποπτεύονται ώστε να διασφαλίζεται ότι δεν παίζουν με τη συσκευή.
- Φυλάσσετε όλα τα υλικά συσκευασίας μακριά από τα παιδιά και απορρίψτε τα κατάλληλα.
- ΠΡΟΕΙΔΟΠΟΙΗΣΗ: Κρατάτε τα παιδιά και τα κατοικίδια ζώα μακριά από τη συσκευή όταν λειτουργεί ή όταν ψύχεται. Τα προσβάσιμα μέρη θερμαίνονται κατά τη χρήση.
- Εάν η συσκευή διαθέτει διάταξη ασφαλείας για παιδιά, θα πρέπει να είναι ενεργοποιημένη.
- Τα παιδιά δεν πρέπει να εκτελούν τον καθαρισμό και τη συντήρηση που εκτελεί ο χρήστης στη συσκευή χωρίς επίβλεψη.

1.2 Γενικές πληροφορίες για την ασφάλεια

- Η εγκατάσταση αυτής της συσκευής και η αντικατάσταση του καλωδίου πρέπει να εκτελείται μόνο από κατάλληλα καταρτισμένο άτομο.
- Μην χρησιμοποιείτε τη συσκευή πριν την εγκαταστήσετε στην ενσωματωμένη δομή.
- Πριν από οποιαδήποτε εργασία συντήρησης, αποσυνδέετε τη συσκευή από την πρίζα.
- Εάν το καλώδιο τροφοδοσίας έχει υποστεί φθορές, θα πρέπει να αντικατασταθεί από τον κατασκευαστή, το Εξουσιοδοτημένο Κέντρο Σέρβις ή ένα κατάλληλα καταρτισμένο άτομο, ώστε να αποφευχθεί τυχόν κίνδυνος από το ηλεκτρικό ρεύμα.

ΟΔΗΓΙΕΣ ΓΙΑ ΤΗΝ ΑΣΦΑΛΕΙΑ

- **ΠΡΟΕΙΔΟΠΟΙΗΣΗ:** Βεβαιωθείτε ότι η συσκευή είναι απενεργοποιημένη προτού αντικαταστήσετε τον λαμπτήρα για την αποφυγή πιθανότητας ηλεκτροπληξίας.
- **ΠΡΟΕΙΔΟΠΟΙΗΣΗ:** Η συσκευή και τα προσβάσιμα μέρη της θερμαίνονται κατά τη χρήση. Χρειάζεται προσοχή για να μην αγγίζετε τις αντιστάσεις.
- Χρησιμοποιείτε πάντα γάντια φούρνου όταν αφαιρείτε ή εισάγετε εξαρτήματα ή σκεύη.
- Για να αφαιρέσετε τα στηρίγματα σχαρών, πρώτα τραβήξτε το μπροστινό άκρο του στηρίγματος σχάρας και κατόπιν το πίσω άκρο από τα πλαϊνά τοιχώματα. Τοποθετήστε τις πλευρικές σχάρες στη θέση τους, ακολουθώντας την παραπάνω διαδικασία με την αντίστροφη σειρά.
- Μη χρησιμοποιείτε ατμοκαθαριστή για τον καθαρισμό της συσκευής.
- Μη χρησιμοποιείτε ισχυρά λειαντικά καθαριστικά ή αιχμηρές μεταλλικές ξύστρες για να καθαρίσετε τη γυάλινη πόρτα, καθότι μπορεί να χαράξουν την επιφάνεια και αυτό μπορεί να προκαλέσει θραύση του γυαλιού.
- Πριν από τον πυρολυτικό καθαρισμό πρέπει να απομακρυνθεί η μεγαλύτερη ποσότητα από τα χυμένα υγρά. Αφαιρέστε όλα τα εξαρτήματα από τον φούρνο.

2. ΟΔΗΓΙΕΣ ΓΙΑ ΤΗΝ ΑΣΦΑΛΕΙΑ

2.1 Εγκατάσταση

**ΠΡΟΕΙΔΟΠΟΙΗΣΗ!**

Η εγκατάσταση αυτής της συσκευής πρέπει να εκτελείται μόνο από κατάλληλα καταρτισμένο άτομο.

- Αφαιρέστε όλα τα υλικά της συσκευασίας.
- Εάν η συσκευή έχει υποστεί ζημιά, μην προβείτε σε εγκατάσταση ή χρήση της.
- Ακολουθείτε τις οδηγίες εγκατάστασης που παρέχονται με τη συσκευή.
- Πάντα να προσέχετε όταν μετακινείτε τη συσκευή καθώς είναι βαριά. Να χρησιμοποιείτε πάντα γάντια ασφαλείας και κλειστά παπούτσια.
- Μην τραβάτε τη συσκευή από τη λαβή.
- Τοποθετήστε τη συσκευή σε κατάλληλο και ασφαλές μέρος που πληροί τις απαιτήσεις εγκατάστασης.
- Τηρείτε την ελάχιστη απόσταση από άλλες συσκευές και μονάδες.
- Πριν τοποθετήσετε τη συσκευή, ελέγξτε αν η πόρτα του φούρνου ανοίγει χωρίς συγκράτηση.

- Η συσκευή είναι εξοπλισμένη με ηλεκτρικό σύστημα ψύξης. Πρέπει να λειτουργεί με την ηλεκτρική παροχή.
- Η ενσωματωμένη μονάδα πρέπει να ικανοποιεί τις απαιτήσεις σταθερότητας του DIN 68930.

Ελάχιστο ύψος ντουλαπιού (Ελάχιστο ύψος ντουλαπιού κάτω από τον πάγκο)	578 (600) mm
Πλάτος ντουλαπιού	560 mm
Βάθος ντουλαπιού	550 (550) mm
Ύψος μπροστινού μέρους της συσκευής	594 mm
Ύψος πίσω μέρους της συσκευής	576 mm
Πλάτος μπροστινού μέρους της συσκευής	595 mm
Πλάτος πίσω μέρους της συσκευής	559 mm
Βάθος της συσκευής	567 mm
Βάθος εντοιχισμού της συσκευής	546 mm
Βάθος με ανοιχτή πόρτα	1027 mm
Ελάχιστο μέγεθος ανοίγματος εξαερισμού. Άνοιγμα στο κάτω μέρος της πίσω πλευράς	560 x 20 mm
Μήκος καλωδίου ηλεκτρικής τροφοδοσίας. Το καλώδιο είναι τοποθετημένο στη δεξιά γωνία στην πίσω πλευρά	1500 mm
Βίδες τοποθέτησης	4 x 25 mm

2.2 Ηλεκτρική σύνδεση



ΠΡΟΕΙΔΟΠΟΙΗΣΗ!

Κίνδυνος πυρκαγιάς και ηλεκτροπληξίας.

- Όλες οι ηλεκτρικές συνδέσεις πρέπει να πραγματοποιούνται από επαγγελματία ηλεκτρολόγο.
- Η συσκευή πρέπει να είναι γειωμένη.
- Βεβαιωθείτε ότι οι παράμετροι στην πινακίδα τεχνικών χαρακτηριστικών είναι συμβατές με τις ονομαστικές τιμές ηλεκτρικού ρεύματος της παροχής ρεύματος.
- Χρησιμοποιείτε πάντα σωστά εγκατεστημένη τριζα με προστασία κατά της ηλεκτροπληξίας.
- Μη χρησιμοποιείτε πολύπριζα και μπαλαντζές.
- Προσέχετε να μην προκληθεί ζημιά στο φως τροφοδοσίας και το καλώδιο τροφοδοσίας. Σε περίπτωση που πρέπει να αντικατασταθεί το καλώδιο τροφοδοσίας της συσκευής, η αντικατάσταση πρέπει να γίνει από το Εξουσιοδοτημένο Κέντρο Σέρβις μας.

- Μην επιτρέπεται σε καλώδια τροφοδοσίας να βρίσκονται κοντά ή να έρχονται σε επαφή με την πόρτα της συσκευής ή με την εσοχή κάτω από τη συσκευή, ιδιαίτερα όταν βρίσκεται σε λειτουργία ή η πόρτα είναι ζεστή.
- Η προστασία από ηλεκτροπληξία των υπό τάση ή μονωμένων τμημάτων πρέπει να στερεώνεται με τέτοιο τρόπο, ώστε να μην είναι δυνατή η αφαίρεσή της χωρίς εργαλεία.
- Συνδέστε το φιν τροφοδοσίας στην πρίζα μόνον αφού έχει ολοκληρωθεί η εγκατάσταση. Μετά την εγκατάσταση, βεβαιωθείτε ότι είναι δυνατή η πρόσβαση στο φιν τροφοδοσίας.
- Εάν η πρίζα είναι χαλαρή, μη συνδέετε το φιν τροφοδοσίας.
- Μην τραβάτε το καλώδιο τροφοδοσίας για να αποσυνδέσετε τη συσκευή. Τραβάτε πάντα το φιν τροφοδοσίας.
- Χρησιμοποιείτε μόνο σωστές μονωτικές διατάξεις: ασφαλειοδιακόπτες, ασφάλειες (βιδωτές ασφάλειες αφαιρούμενες από την υποδοχή), διακόπτες διαφυγής ρεύματος και ρελέ.
- Στην ηλεκτρική εγκατάσταση της συσκευής πρέπει να προβλέπεται μονωτική διάταξη που να επιτρέπει την αποσύνδεση της συσκευής από το δίκτυο ρεύματος από όλους τους πόλους. Η μονωτική διάταξη πρέπει να έχει ελάχιστη απόσταση 3 mm μεταξύ των επαφών.
- Κλείστε καλά την πόρτα της συσκευής πριν συνδέσετε το φιν τροφοδοσίας στην πρίζα.
- Αυτή η συσκευή παρέχεται με φιν και καλώδιο τροφοδοσίας.

2.3 Χρήση



ΠΡΟΕΙΔΟΠΟΙΗΣΗ!

Κίνδυνος τραυματισμού, εγκαυμάτων και ηλεκτροπληξίας ή έκρηξης.

- Αυτή η συσκευή προορίζεται μόνο για οικιακή χρήση (εσωτερικοί χώροι).
- Μην αλλάζετε τις προδιαγραφές αυτής της συσκευής.
- Φροντίστε τα ανοίγματα αερισμού να είναι ελεύθερα από εμπόδια.
- Μην αφήνετε τη συσκευή χωρίς επιτήρηση κατά τη λειτουργία.
- Απενεργοποιήστε τη συσκευή μετά από κάθε χρήση.
- Προσέχετε όταν ανοίγετε την πόρτα της συσκευής με τη συσκευή σε λειτουργία. Μπορεί να απελευθερωθεί ζεστός αέρας.
- Μην λειτουργείτε τη συσκευή με βρεγμένα χέρια ή όταν είναι σε επαφή με νερό.
- Μην ασκείτε πίεση στην ανοιχτή πόρτα.
- Μη χρησιμοποιείτε τη συσκευή ως επιφάνεια εργασίας ή ως επιφάνεια αποθήκευσης αντικειμένων.
- Ανοίξτε την πόρτα της συσκευής προσεκτικά. Η χρήση συστατικών με αλκοόλη μπορεί να δημιουργήσει ένα μείγμα αλκοόλης με αέρα.
- Μην αφήνετε σπίθες ή γυμνές φλόγες να έρθουν σε επαφή με τη συσκευή όταν ανοίγετε την πόρτα.
- Μην τοποθετείτε εύφλεκτα προϊόντα ή στοιχεία που είναι βρεγμένα με εύφλεκτα προϊόντα μέσα, κοντά ή πάνω στη συσκευή.



ΠΡΟΕΙΔΟΠΟΙΗΣΗ!

Κίνδυνος πρόκλησης ζημιάς στη συσκευή.

- Για την αποφυγή βλάβης ή αποχρωματισμού στο σμάλτο:
 - μην τοποθετείτε σκεύη ή άλλα αντικείμενα μέσα στη συσκευή απευθείας σε επαφή με το κάτω μέρος της.
 - μην τοποθετείτε αλουμινοχαρτο απευθείας σε επαφή με το κάτω μέρος του εσωτερικού της συσκευής.
 - μην τοποθετείτε νερό απευθείας μέσα στη ζεστή συσκευή.
 - μην διατηρείτε υγρά πιάτα και τρόφιμα στη συσκευή αφού τελειώσετε το μαγείρεμα.

- προσέχετε όταν αφαιρείτε ή τοποθετείτε τα αξεσουάρ.
- Ο αποχρωματισμός της εμαγιέ επιφάνειας ή της επιφάνειας από ανοξείδωτο ατσάλι δεν επηρεάζει την απόδοση της συσκευής.
- Χρησιμοποιήστε ένα βαθύ ταπί για υγρά κέικ. Οι χυμοί φρούτων προκαλούν λεκέδες που μπορεί να είναι μόνιμοι.
- Αυτή η συσκευή προορίζεται μόνο για μαγειρική χρήση. Δεν μπορεί να χρησιμοποιηθεί για άλλους σκοπούς, όπως για παράδειγμα για τη θέρμανση δωματίου.
- Να μαγειρεύετε πάντα με την πόρτα του φούρνου κλειστή.
- Αν η συσκευή έχει εγκατασταθεί πίσω από ένα πλαίσιο επίπλου (π.χ. μια πόρτα) φροντίστε η πόρτα να μην είναι ποτέ κλειστή όσο η συσκευή βρίσκεται σε λειτουργία. Μπορεί να συσσωρευτεί θερμότητα και υγρασία σε ένα κλειστό πλαίσιο επίπλου και να προκληθεί ζημιά στη συσκευή, την κατοικία ή το δάπεδο. Μην κλείνετε το πλαίσιο του επίπλου προτού η συσκευή κρυώσει μετά τη χρήση.

2.4 Φροντίδα και καθαρίσμα



ΠΡΟΕΙΔΟΠΟΙΗΣΗ!

Κίνδυνος τραυματισμού, πυρκαγιάς, ή βλάβης της συσκευής.

- Πριν από την πραγματοποίηση συντήρησης, απενεργοποιήστε τη συσκευή και αποσυνδέστε το φις τροφοδοσίας από την πρίζα.
- Βεβαιωθείτε ότι η συσκευή είναι κρύα. Υπάρχει κίνδυνος θραύσης των τζαμιών.
- Αντικαταστήστε άμεσα τα τζάμια της πόρτας όταν έχουν υποστεί ζημιά. Επικοινωνήστε με το Εξουσιοδοτημένο Κέντρο Σέρβις.
- Απαιτείται προσοχή κατά την αφαίρεση της πόρτας από τη συσκευή. Η πόρτα είναι βαριά!
- Καθαρίζετε τακτικά τη συσκευή για να αποτραπεί η φθορά του υλικού της επιφάνειας.
- Καθαρίστε τη συσκευή με ένα υγρό μαλακό πανί. Χρησιμοποιείτε μόνο ουδέτερα απορροπαντικά. Μη χρησιμοποιείτε λειαντικά προϊόντα, σφουγγαράκια που χαράσσουν, διαλύτες ή μεταλλικά αντικείμενα.
- Αν χρησιμοποιείτε σπρέι καθαρισμού για φούρνους, ακολουθείτε τις οδηγίες ασφαλείας στη συσκευασία.

2.5 Πυρολυτικός καθαρισμός



ΠΡΟΕΙΔΟΠΟΙΗΣΗ!

Κίνδυνος τραυματισμού / Πυρκαγιών / Χημικών εκπομπών (Αναθυμιάσεων) σε Πυρολυτική Λειτουργία.

- Πριν πραγματοποιήσετε μια λειτουργία Πυρολυτικού αυτοκαθαρισμού ή την Πρώτη Χρήση, αφαιρέστε από το εσωτερικό του φούρνου:
 - τυχόν υπερβολική ποσότητα υπολειμμάτων τροφίμων, λαδιού ή λεκέδων από λίπη / επικαθίσεων.
 - τυχόν αφαιρούμενα αντικείμενα (συμπεριλαμβανομένων σχαρών, πλευρικών σχαρών κ.λπ., που παρέχονται μαζί με το προϊόν), και ιδιαίτερα τυχόν αντικολητικά μαγειρικά σκεύη, ταψιά, οικιακά σκεύη κ.λπ.
- Διαβάστε προσεκτικά όλες τις οδηγίες σχετικά με τον Πυρολυτικό καθαρισμό.
- Κρατήστε τα παιδιά μακριά από τη συσκευή ενώ βρίσκεται σε λειτουργία ο Πυρολυτικός καθαρισμός.
Η συσκευή θερμαίνεται πάρα πολύ και απελευθερώνεται ζεστός αέρας από τα μπροστινά ανοίγματα αερισμού.

ΠΕΡΙΓΡΑΦΉ ΠΡΟΪΟΝΤΟΣ

- Ο Πυρολυτικός καθαρισμός είναι μια λειτουργία υψηλής θερμοκρασίας, η οποία μπορεί να προκαλέσει αναθυμιάσεις από τα υπολείμματα μαγειρέματος και τα υλικά κατασκευής. Για αυτό το λόγο, οι καταναλωτές συνιστάται να:
 - παρέχουν καλό αερισμό κατά τη διάρκεια και μετά από κάθε διαδικασία Πυρολυτικού καθαρισμού.
 - παρέχουν καλό αερισμό κατά τη διάρκεια και μετά την πρώτη χρήση σε μέγιστη ρύθμιση θερμοκρασίας.
- Σε αντίθεση με τους ανθρώπους, κάποια πουλιά και ερπετά μπορεί να είναι εξαιρετικά ευαίσθητα στις πιθανές αναθυμιάσεις που εκπέμπονται κατά τη διαδικασία καθαρισμού κάθε Πυρολυτικού Φούρνου.
 - Απομακρύνετε τυχόν κατοικίδια (ιδιαίτερα τα πουλιά) από την περιοχή γύρω από τη συσκευή κατά τη διάρκεια και μετά από τον Πυρολυτικό καθαρισμό, και χρησιμοποιήστε αρχικά τη μέγιστη ρύθμιση θερμοκρασίας σε έναν καλά αεριζόμενο χώρο.
- Τα μικρά κατοικίδια μπορεί επίσης να είναι εξαιρετικά ευαίσθητα στις τοπικές αλλαγές θερμοκρασίας στην περιοχή κάθε Πυρολυτικού Φούρνου, όταν βρίσκεται σε λειτουργία το πρόγραμμα Πυρολυτικού αυτοκαθαρισμού.
- Οι αντικολλητικές επιφάνειες μαγειρικών σκευών, ταψιών, οικιακών σκευών κ.λπ. μπορούν να υποστούν ζημιά από τη λειτουργία του Πυρολυτικού καθαρισμού υψηλής θερμοκρασίας κάθε Πυρολυτικού Φούρνου και μπορούν επίσης να είναι πηγή επιβλαβών αναθυμιάσεων χαμηλού επιπέδου.
- Οι αναθυμιάσεις που απελευθερώνονται όπως περιγράφηκε από όλους τους Πυρολυτικούς Φούρνους / Υπολείμματα Μαγειρέματος, δεν είναι επιβλαβείς για τον άνθρωπο, συμπεριλαμβανομένων των παιδιών και των ατόμων με ιατρικές παθήσεις.

2.6 Εσωτερικός φωτισμός



ΠΡΟΕΙΔΟΠΟΙΗΣΗ!

Κίνδυνος ηλεκτροπληξίας.

- Σχετικά με τον/τους λαμπτήρα/λαμπτήρες εντός αυτού του προϊόντος και τους ανταλλακτικούς λαμπτήρες που πωλούνται ξεχωριστά: Αυτοί οι λαμπτήρες προορίζονται ώστε να αντέχουν σε εξαιρετικά δύσκολες συνθήκες σε οικιακές συσκευές, όπως σε θερμοκρασίες, δονήσεις, υγρασία ή προορίζονται να σηματοδοτούν πληροφορίες σχετικά με τη λειτουργική κατάσταση της συσκευής. Δεν προορίζονται για χρήση σε άλλες εφαρμογές και δεν είναι κατάλληλοι για τον φωτισμό οικιακών χώρων.
- Χρησιμοποιείτε μόνο λαμπτήρες με τις ίδιες προδιαγραφές.

2.7 Σέρβις

- Για την επισκευή της συσκευής, επικοινωνήστε με το Εξουσιοδοτημένο Κέντρο Σέρβις.
- Χρησιμοποιείτε μόνο γνήσια ανταλλακτικά.

2.8 Απόρριψη



ΠΡΟΕΙΔΟΠΟΙΗΣΗ!

Κίνδυνος τραυματισμού ή ασφυξίας.

- Αποσυνδέστε τη συσκευή από την παροχή ρεύματος.
- Κόψτε το καλώδιο τροφοδοσίας κοντά στη συσκευή και απορρίψτε το.
- Αφαιρέστε το μάνταλο της πόρτας για να αποτραπεί ο εγκλεισμός παιδιών ή ζώων μέσα στη συσκευή.

3. ΠΕΡΙΓΡΑΦΉ ΠΡΟΪΟΝΤΟΣ

3.1 Γενική επισκόπηση

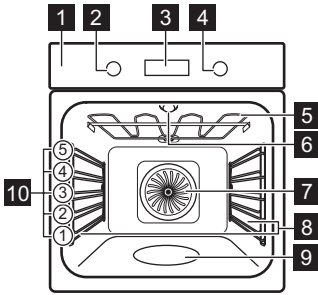

- 1** Πίνακας χειριστηρίων
- 2** Διακόπτης προγραμμάτων θέρμανσης
- 3** Οθόνη
- 4** Διακόπτης λειτουργίας
- 5** Αντίσταση
- 6** Λαμπτήρας
- 7** Ανεμιστήρας
- 8** Στήριξη σχάρας, αφαιρούμενη
- 9** Θέσεις σχάρας
- 10** Ανάγλυφο τμήμα εσωτερικού του φούρνου

3.2 Αξεσουάρ

Μεταλλική σχάρα

Για μαγειρικά σκεύη, φόρμες για κέικ, ψητά.

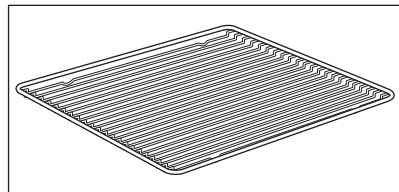

Ταψί ψησίματος

Για κέικ και μπισκότα.

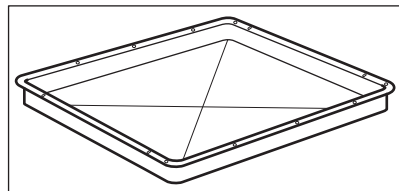

ΓΙΑ ΕΝΕΡΓΟΠΟΪΗΣΗ ΚΑΙ ΑΠΕΝΕΡΓΟΠΟΪΗΣΗ ΤΟΥ ΦΟΥΡΝΟΥ

Ταψί ψησίματος / γκριλ

Για το ψήσιμο ή ως ένα σκεύος για τη συλλογή του λίπους.

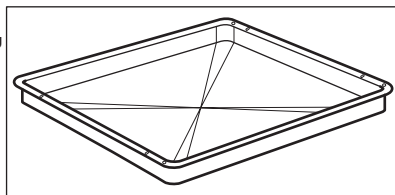

Τηλεσκοπικοί βραχίονες

Για την ευκολότερη τοποθέτηση και αφαίρεση τασιών και μεταλλικών σχαρών.

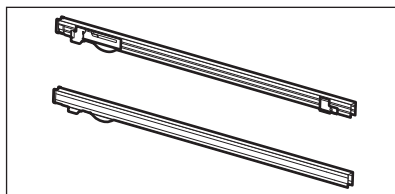







4. ΓΙΑ ΕΝΕΡΓΟΠΟΪΗΣΗ ΚΑΙ ΑΠΕΝΕΡΓΟΠΟΪΗΣΗ ΤΟΥ ΦΟΥΡΝΟΥ

4.1 Βυθιζόμενοι διακόπτες

Για να χρησιμοποιήσετε τη συσκευή, πιάστε τον διακόπτη. Ο διακόπτης πετάγεται προς τα έξω.

4.2 Πίνακας χειριστηρίων

Πεδία αισθητήρα πίνακα ελέγχου					Πιάστε το κουμπί	Στρέψτε τον διακόπτη
 Χρονο-διακόπτης	 Ταχεία προθέρμανση	 Φωτισμός Φούρνου	 Lock	OK		

Επιλέξτε ένα πρόγραμμα ζεστάματος για να ενεργοποιήσετε τον φούρνο.

Στρέψτε τον διακόπτη προγραμμάτων ζεστάματος στη θέση απενεργοποίησης για να απενεργοποιήσετε τον φούρνο.

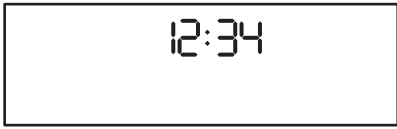
	Όταν ο διακόπτης προγραμμάτων ζεστάματος βρίσκεται στη θέση απενεργοποίησης η οθόνη τίθεται σε κατάσταση αναμονής.
---	--

ΠΡΙΝ ΤΗΝ ΠΡΩΤΗ ΧΡΗΣΗ

	<p>Όταν μαγειρεύετε, η οθόνη εμφανίζει τη ρυθμισμένη θερμοκρασία, την ώρα και άλλες διαθέσιμες επιλογές.</p>
	<p>Η οθόνη με τον μέγιστο αριθμό ρυθμισμένων λειτουργιών.</p>

Ενδείξεις οθόνης

Κλείδωμα	Μαγείρεμα με βοήθεια	Καθαρισμός	Ρυθμίσεις	Ταχεία προθέρμανση
Ενδείξεις χρονοδιακόπτη:				

Μπάρα προόδου - για τη θερμοκρασία ή τον χρόνο.	
---	--

Ένδειξη μαγειρέματος στον ατμό	
--------------------------------	--

5. ΠΡΙΝ ΤΗΝ ΠΡΩΤΗ ΧΡΗΣΗ

	<p>ΠΡΟΕΙΔΟΠΟΙΗΣΗ! Ανατρέξτε στα κεφάλαια σχετικά με την Ασφάλεια.</p>
--	--

5.1 Αρχικός καθαρισμός

Πριν από την πρώτη χρήση, καθαρίστε τον άδειο φούρνο και ρυθμίστε την ώρα:			
			<p>0:00. Ρυθμίστε τον χρονοδιακόπτη. Πιέστε το κουμπι OK.</p>

5.2 Αρχική προθέρμανση



Προθερμάνετε τον άδειο φούρνο πριν από την πρώτη χρήση.

Βήμα 1	Αφαιρέστε όλα τα εξαρτήματα και τα αποσπώμενα στηρίγματα σαχαρών από τον φούρνο.
Βήμα 2	Ρυθμίστε τη μέγιστη θερμοκρασία για τη λειτουργία: . Αφήστε τον φούρνο να λειτουργήσει για 1 ώ.
Βήμα 3	Ρυθμίστε τη μέγιστη θερμοκρασία για τη λειτουργία: . Αφήστε τον φούρνο να λειτουργήσει για 15 λεπτά.

Από τον φούρνο μπορεί να αναδυθεί μια οσμή και καπνός κατά τη διάρκεια της προθέρμανσης. Βεβαιωθείτε ότι το δωμάτιο αερίζεται.

6. ΚΑΘΗΜΕΡΙΝΉ ΧΡΉΣΗ



ΠΡΟΕΙΔΟΠΟΙΗΣΗ!

Ανατρέξτε στα κεφάλαια σχετικά με την Ασφάλεια.

6.1 Τρόπος ρύθμισης: Προγράμματα θέρμανσης





Ξεκινήστε το μαγείρεμα	
Βήμα 1	Βήμα 2
Ρυθμίστε ένα πρόγραμμα.	Ρυθμίστε τη θερμοκρασία.

Μαγείρεμα με ατμό

Βεβαιωθείτε ότι ο φούρνος είναι κρύος.

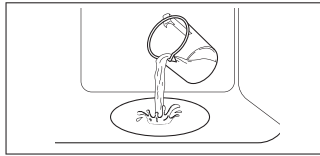
Βήμα 1	Βήμα 2	Βήμα 3	Βήμα 4
---------------	---------------	---------------	---------------

Μαγείρεμα με ατμό



	 	 °C	<p>Προθερμάνετε τον κενό φούρνο για 10 λεπ. για να δημιουργηθεί υγρασία.</p> <p>Τοποθετήστε το φαγητό στον φούρνο.</p>
Γεμίστε το ανάγλυφο τμήμα του εσωτερικού του φούρνου με νερό της βρύσης.	Ρυθμίστε το πρόγραμμα ατμού.	Ρυθμίστε τη θερμοκρασία.	
<p>i Η μέγιστη χωρητικότητα του ανάγλυφου τμήματος του εσωτερικού του φούρνου είναι 250 ml. Μη γεμίζετε το ανάγλυφο τμήμα του εσωτερικού του φούρνου κατά τη διάρκεια μαγειρέματος ή όταν ο φούρνος είναι ζεστός.</p>			









Όταν τελειώσει το μαγείρεμα με ατμό:

Βήμα 1	Βήμα 2	Βήμα 3
Στρέψτε τον διακόπτη προγραμμάτων ζεστάματος στη θέση απενεργοποίησης για να απενεργοποιήσετε τον φούρνο.	Ανοίξτε προσεκτικά την πόρτα. Η υγρασία που απελευθερώνεται μπορεί να προκαλέσει εγκαύματα.	Βεβαιωθείτε ότι ο φούρνος είναι κρύος. Αφαιρέστε το υπόλοιπο νερό από το ανάγλυφο τμήμα του εσωτερικού του φούρνου.

6.2 Προγράμματα

Βασικά προγράμματα

Πρόγραμμα θέρμανσης	Εφαρμογή
 Θερμός Αέρας	Για ψήσιμο μέχρι και σε τρεις θέσεις σχαρών ταυτόχρονα και για ξήρανση φαγητού. Ρυθμίστε τη θερμοκρασία κατά 20 - 40 °C χαμηλότερα από ό,τι για τη λειτουργία Πάνω/Κάτω Θέρμανση.
 Πάνω/Κάτω Θέρμανση	Για ψήσιμο σε μία θέση σχάρας.

Πρόγραμμα θέρμανσης	Εφαρμογή
 SteamBake	Για την προσθήκη υγρασίας κατά το μαγείρεμα. Για την εξασφάλιση σωστού χρώματος και τραγανής κρούστας κατά το ψήσιμο. Για να γίνει το φαγητό πιο ζουμερό κατά το ξαναζέσταμα. Για τη διατήρηση φρούτων ή λαχανικών.
 Λειτουργία Πίτσα	Για ψήσιμο πίτσας. Για εντατικό ρόδισμα και τραγανή βάση.
 Κάτω Θέρμανση	Για το ψήσιμο κέικ με τραγανή βάση και τη συντήρηση τροφίμων.
 Καταψυγμένα τρόφιμα	Για να γίνουν τραγανά τα έτοιμα φαγητά (π.χ. οι τηγανιτές πατάτες, οι κυδωνάτες πατάτες ή τα σπρινγκ ρολς).
 Υγρός Θερμός Αέρας	Αυτή η λειτουργία σχεδιάστηκε για να εξοικονομείτε ενέργεια κατά το ψήσιμο. Όταν χρησιμοποιείτε αυτή τη λειτουργία, η θερμοκρασία στο εσωτερικό του φούρνου μπορεί να διαφέρει από τη ρυθμισμένη θερμοκρασία. Χρησιμοποιείται η υπολειπόμενη θερμότητα. Η θερμαντική ισχύς μπορεί να μειωθεί. Για περισσότερες πληροφορίες, ανατρέξτε στο κεφάλαιο «Καθημερινή χρήση», Σημειώσεις σχετικά με: Υγρός Θερμός Αέρας .
 Γκριλ	Για ψήσιμο στο γκριλ λεπτών κομματιών φαγητού καθώς και για φρυγάνισμα ψωμιού.
 Γκριλ με Θερμό Αέρα	Για ψήσιμο μεγάλων μερίδων κρέατος ή πουλερικών με κόκαλα σε μία θέση σχάρας. Για γκρατινάρισμα και για ρόδισμα.
 Μενού	Για να εισέλθετε στο Μενού: Μαγείρεμα με βοήθεια, Καθαρισμός, Ρυθμίσεις.

6.3 Σημειώσεις σχετικά με: Υγρός Θερμός Αέρας

Αυτή η λειτουργία χρησιμοποιούνταν για συμμόρφωση με την τάξη ενεργειακής απόδοσης και τις απαιτήσεις για τον οικολογικό σχεδιασμό σύμφωνα με τα πρότυπα της ΕΕ 65/2014 και ΕΕ 66/2014. Δοκιμές σύμφωνα με το EN 60350-1.





Η πόρτα του φούρνου θα πρέπει να είναι κλειστή κατά τη διάρκεια του μαγειρέματος, έτσι ώστε η λειτουργία να μη διακόπτεται και ο φούρνος να λειτουργεί με την υψηλότερη δυνατή ενεργειακή απόδοση.

Όταν χρησιμοποιείτε αυτήν τη λειτουργία, ο λαμπτήρας απενεργοποιείται αυτόματα μετά από 30 δευτερόλεπτα.



Για τις οδηγίες μαγειρέματος ανατρέξτε στο κεφάλαιο «Υποδείξεις και συμβουλές» Υγρός Θερμός Αέρας . Για γενικές συστάσεις εξοικονόμησης ενέργειας, ανατρέξτε στο κεφάλαιο «Ενεργειακή Απόδοση», Εξοικονόμηση Ενέργειας.

6.4 Τρόπος ρύθμισης: Μαγείρεμα με βοήθεια

Για κάθε φαγητό σε αυτό το υπομενού παρέχεται προτεινόμενο πρόγραμμα και θερμοκρασία. Μπορείτε να ρυθμίσετε τον χρόνο και τη θερμοκρασία κατά τη διάρκεια του μαγειρέματος.

Μαγείρεμα με βοήθεια - χρησιμοποιήστε το για να προετοιμάσετε γρήγορα ένα πιάτο με τις προεπιλεγμένες ρυθμίσεις:			
Βήμα 1	Βήμα 2	Βήμα 3	Βήμα 4
 ≡	 ✂	 1 - 45	 OK
Εισέλθετε στο μενού.	Επιλέξτε Μαγείρεμα με βοήθεια. Πατήστε το OK.	Επιλέξτε το σκεύος. Πιέστε το κουμπί OK.	Τοποθετήστε το σκεύος στον φούρνο. Επιβεβαιώστε τη ρύθμιση.

6.5 Μαγείρεμα με βοήθεια με συνταγές









Λεζάντα	
	Η ποσότητα νερού για τη λειτουργία ατμού.
	Προθερμάνετε τον φούρνο πριν ξεκινήσετε το μαγείρεμα.
	Επίπεδο σχάρας.

Όταν τελειώσει το πρόγραμμα, ελέγξτε αν το φαγητό είναι έτοιμο.











	Σκεύος	Βάρος	Επίπεδο σχάρας / Αξεσουάφ	Διάρκεια
Βοδινό 				

















ΚΑΘΗΜΕΡΙΝΉ ΧΡΉΣΗ

	Σκεύος	Βάρος	Επίπεδο σχάρας / Αξισουάρ	Διάρκεια
P1	Ψητό βοδινό, λίγο ψημένο	1 - 1,5 kg, φέτες πάχους 4 - 5 cm	☐ 2, ταψί ψησίματος Τηγανίστε το κρέας για μερικά λεπτά σε ένα ζεστό τηγάνι. Τοποθετήστε στον φούρνο.	40 λεπ.
P2	Ψητό βοδινό, μέτρια ψημένο			50 λεπ.
P3	Ψητό βοδινό, καλοψημένο			60 λεπ.
P4	Μπριζόλα, μέτρια ψημένη	180 - 220 g το τεμάχιο, φέτες πάχους 3 cm	☐☐ 3, σκεύος ψησίματος στη μεταλλική σχάρα Τηγανίστε το κρέας για μερικά λεπτά σε ένα ζεστό τηγάνι. Τοποθετήστε στον φούρνο.	15 λεπ.
P5	Ψητό βοδινό / σιγουπημένο (σπαλομπριζόλα, στρογγυλή, κόντρα μπριζόλα)	1,5 - 2 kg	☐ 2, σκεύος ψησίματος στη μεταλλική σχάρα Τηγανίστε το κρέας για μερικά λεπτά σε ένα ζεστό τηγάνι. Προσθέστε υγρά. Τοποθετήστε στον φούρνο.	120 λεπ.
P6	Ψητό βοδινό, λίγο ψημένο (χαμηλή θερμοκρασία)	1 - 1,5 kg, φέτες πάχους 4 - 5 cm	☐ 2, ταψί ψησίματος Χρησιμοποιήστε τα αγαπημένα σας μπαχαρικά ή απλώς αλάτι και φρεσκοτριμμένο πιπέρι. Τηγανίστε το κρέας για μερικά λεπτά σε ένα ζεστό τηγάνι. Τοποθετήστε στον φούρνο.	75 λεπ.
P7	Ψητό βοδινό, μέτρια ψημένο (χαμηλή θερμοκρασία)			85 λεπ.
P8	Ψητό βοδινό, καλοψημένο (χαμηλή θερμοκρασία)			130 λεπ.

















	Σκεύος	Βάρος	Επίπεδο σχάρας / Αξεσουάρ	Διάρκεια
P9	Φιλέτο, λίγο ψημένο (χαμηλή θερμοκρασία)	0,5 - 1,5 kg, φέτες πάχους 5 - 6 cm	 2, ταψί ψησίματος Χρησιμοποιήστε τα αγαπημένα σας μπαχαρικά ή απλώς αλάτι και φρεσκοτριμμένο πιπέρι. Τηγανίστε το κρέας για μερικά λεπτά σε ένα ζεστό τηγάνι. Τοποθετήστε στον φούρνο.	75 λεπ.
P10	Φιλέτο, μέτρια ψημένο (χαμηλή θερμοκρασία)			90 λεπ.
P11	Φιλέτο, καλοψημένο (χαμηλή θερμοκρασία)			120 λεπ.
Μοσχάρι 				
P12	Ψητό μοσχάρι (π.χ. ωμοπλάτη)	0,8 - 1,5 kg, κομμάτια πάχους 4 cm	 2, σκεύος ψησίματος στη μεταλλική σχάρα Χρησιμοποιήστε τα αγαπημένα σας μπαχαρικά. Προσθέστε υγρά. Ψητό σκεπαστό.	80 λεπ.
Χοιρινό  				
P13	Ψητός χοιρινός λαιμός ή ωμοπλάτη	1,5 - 2 kg	 2, σκεύος ψησίματος πάνω στη μεταλλική σχάρα Γυρίστε το κρέας μόλις περάσει ο μισός χρόνος μαγειρέματος.	120 λεπ.
P14	Χοιρινό πουλντ LTC	1,5 - 2 kg	 2, ταψί ψησίματος Χρησιμοποιήστε τα αγαπημένα σας μπαχαρικά. Γυρίστε το κρέας μόλις περάσει ο μισός χρόνος μαγειρέματος για να έχετε ένα ομοιόμορφο ρόδισμα.	215 λεπ.
P15	Μπριζόλα, φρέσκια	1 - 1,5 kg, φέτες πάχους 5 - 6 cm	 2, σκεύος ψησίματος πάνω στη μεταλλική σχάρα Χρησιμοποιήστε τα αγαπημένα σας μπαχαρικά.	55 λεπ.



ΚΑΘΗΜΕΡΙΝΉ ΧΡΉΣΗ

	Σκεύος	Βάρος	Επίπεδο σχάρας / Αξισουάρ	Διάρκεια
P16	Παιδάκια	2 - 3 kg, χρησιμο- ποιήστε ωμό, λεπτά παιδάκια πάχους 2 - 3 cm	 3, βαθύ ταψί Προσθέστε υγρά για να καλύψετε τον πά- το ενός σκεύους. Γυρίστε το κρέας μόλις περάσει ο μισός χρόνος μαγειρέματος.	90 λεπ.
Αρνί 				
P17	Μπούτι αρ- νιού με κόκα- λα	1,5 - 2 kg, φέτες πάχους 7 - 9 cm	 2, σκεύος ψησίματος πάνω στη με- ταλλική σχάρα Προσθέστε υγρά. Γυρίστε το κρέας μόλις περάσει ο μισός χρόνος μαγειρέματος.	130 λεπ.
Πουλερικά 				
P18	Ολόκληρο κο- τόπουλο	1 - 1,5 kg, φρέσκο	 2,  200 ml, γάστρα πάνω στο τα- ψί ψησίματος Χρησιμοποιήστε τα αγαπημένα σας μπα- χαρικά. Γυρίστε το κοτόπουλο μόλις πε- ράσει ο μισός χρόνος μαγειρέματος για να έχετε ένα ομοιόμορφο ρόδισμα.	60 λεπ.
P19	Μισό κοτό- πουλο	0,5 - 0,8 kg	 3, ταψί ψησίματος Χρησιμοποιήστε τα αγαπημένα σας μπα- χαρικά.	40 λεπ.
P20	Στήθος κοτό- πουλου	180 - 200 g το τεμάχιο	  2, γάστρα πάνω στη μεταλλική σχάρα Χρησιμοποιήστε τα αγαπημένα σας μπα- χαρικά. Τηγανίστε το κρέας για μερικά λε- πτά σε ένα ζεστό τηγάνι.	25 λεπ.
P21	Κοτόπουλο μπούτια, φρέ- σκα	-	 3, ταψί ψησίματος Αν μαρινάρετε πρώτα τα μπούτια, ρυθμί- στε τη χαμηλότερη θερμοκρασία και μα- γειρέψτε τα περισσότερη ώρα.	30 λεπ.

	Σκεύος	Βάρος	Επίπεδο σάκχρας / Αξεσουάρ	Διάρκεια
P22	Πάπια, ολόκληρη	2 - 3 kg	 2, σκεύος ψησίματος στη μεταλλική σάκχρα Χρησιμοποιήστε τα αγαπημένα σας μπαχαρικά. Τοποθετήστε το κρέας στο σκεύος ψησίματος. Γυρίστε την πάπια μόλις περάσει ο μισός χρόνος μαγειρέματος.	100 λεπ.
P23	Χήνα, ολόκληρη	4 - 5 kg	 2, βαθύ ταψί Χρησιμοποιήστε τα αγαπημένα σας μπαχαρικά. Τοποθετήστε το κρέας σε βαθύ ταψί ψησίματος. Γυρίστε τη χήνα μόλις περάσει ο μισός χρόνος μαγειρέματος.	110 λεπ.
Άλλα 				
P24	Ρολό κιμάς	1 kg	 2, μεταλλική σάκχρα Χρησιμοποιήστε τα αγαπημένα σας μπαχαρικά.	60 λεπ.
 Ψάρι				
P25	Ψάρι ολόκληρο, στο γκριλ	0,5 - 1 kg ανά ψάρι	 2, ταψί ψησίματος Γεμίστε το ψάρι με βούτυρο και χρησιμοποιήστε τα αγαπημένα σας μπαχαρικά και μυρωδικά.	30 λεπ.
P26	Ψάρι φιλέτο	-	  3, γάστρα πάνω στη μεταλλική σάκχρα Χρησιμοποιήστε τα αγαπημένα σας μπαχαρικά.	20 λεπ.
Ψήσιμο γλυκών / επιδόρπια   				
P27	Cheesecake	-	 2,  ανοιγόμενη φόρμα 28 cm πάνω στη μεταλλική σάκχρα	90 λεπ.
P28	Μηλόπιτα	-	 2,  100 - 150 ml, ταψί ψησίματος	60 λεπ.
P29	Τάρτα μήλου	-	 2, φόρμα για πίτες πάνω στη μεταλλική σάκχρα	40 λεπ.



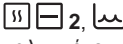
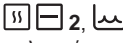

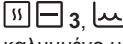
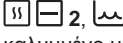
ΚΑΘΗΜΕΡΙΝΉ ΧΡΉΣΗ

	Σκεύος	Βάρος	Επίπεδο σχάρας / Αξεσουάρ	Διάρκεια
P30	Μηλόπιτα	-	 2,  100 - 150 ml,  φόρμα για πίτες 22 cm πάνω στη μεταλλική σχάρα	60 λεπ.
P31	Κέικ Brownies	2 kg	 3, βαθύ ταψί	30 λεπ.
P32	Κέικ muffins σοκολάτας	-	 2,  100 - 150 ml, ταψί για muffin πάνω στη μεταλλική σχάρα	30 λεπ.
P33	Κέικ	-	 2, ταψί φρατζόλας πάνω στη μεταλλική σχάρα	50 λεπ.
Λαχανικά / Συνοδευτικά πιάτα 				
P34	Ψητές πατάτες	1 kg	 2, ταψί ψησίματος Τοποθετήστε ολόκληρες τις πατάτες με τη φλούδα πάνω στο ταψί ψησίματος.	50 λεπ.
P35	Φέτες	1 kg	 3, ταψί ψησίματος καλυμμένο με χαρτί ψησίματος Χρησιμοποιήστε τα αγαπημένα σας μπαχαρικά. Κόψτε τις πατάτες σε κομμάτια.	35 λεπ.
P36	Ψητά ανάμικτα λαχανικά	1 - 1,5 kg	 3, ταψί ψησίματος καλυμμένο με χαρτί ψησίματος Χρησιμοποιήστε τα αγαπημένα σας μπαχαρικά. Κόψτε τα λαχανικά σε κομμάτια.	30 λεπ.
P37	Κροκέτες, κατεψυγμένες	0,5 kg	 3, ταψί ψησίματος	25 λεπ.
P38	Πατάτες, κατεψυγμένες	0,75 kg	 3, ταψί ψησίματος	25 λεπ.
Γκρατινάρισμα, ψωμί και πίτσα 				
P39	Λαζάνια / Νουντλ στη γάστρα	1 - 1,5 kg	 2, γάστρα πάνω στη μεταλλική σχάρα	45 λεπ.
P40	Πατάτες Ογκρατέν	1 - 1,5 kg	 1, γάστρα πάνω στη μεταλλική σχάρα	50 λεπ.



	Σκεύος	Βάρος	Επίπεδο σχάρας / Αξεσουάρ	Διάρκεια
P41	Φρέσκια πίτσα, λεπτή ζύμη	-	 2, 100 ml, ταψί ψησίματος καλυμμένο με χαρτί ψησίματος	15 λεπ.
P42	Πίτσα φρέσκια, χοντρή ζύμη	-	 2, 100 ml, ταψί ψησίματος καλυμμένο με χαρτί ψησίματος	25 λεπ.
P43	Κις	-	 2, φόρμα ψησίματος πάνω στη μεταλλική σχάρα	45 λεπ.
P44	Μπαγκέτα / Ciabatta / Λευκό ψωμί	0,8 kg	 3, 150 ml, ταψί ψησίματος καλυμμένο με χαρτί ψησίματος Χρειάζεται περισσότερος χρόνος για το λευκό ψωμί.	30 λεπ.
P45	Πολύσπορο / σίκαλης / μαύρο ψωμί πολύσπορο σε ταψί φρατζόλας	1 kg	 2, 150 ml, ταψί ψησίματος καλυμμένο με χαρτί ψησίματος / μεταλλική σχάρα	45 λεπ.





7. ΛΕΙΤΟΥΡΓΙΕΣ ΡΟΛΟΓΙΟΥ







7.1 Λειτουργίες ρολογιού

Λειτουργία ρολογιού	Εφαρμογή
	Χρονομετρητής. Όταν ο χρονοδιακόπτης σταματήσει, ακούγεται ένα ηχητικό σήμα.
	Χρόνος μαγειρέματος. Όταν ο χρονοδιακόπτης σταματήσει, ακούγεται ένα ηχητικό σήμα και το πρόγραμμα ζεστάματος σταματά.
	Καθυστέρηση Έναρξης. Για αναβολή της έναρξης ή / και του τέλους του μαγειρέματος.
	Χρονοδιακόπτης λειτουργίας. Η μέγιστη διάρκεια είναι 23 ώ 59 λεπ. Η λειτουργία αυτή δεν έχει καμία επίδραση στη λειτουργία του φούρνου. Για να ενεργοποιήσετε και να απενεργοποιήσετε το Χρονοδιακόπτης λειτουργίας επιλέξτε: Μενού, Ρυθμίσεις.









7.2 Τρόπος ρύθμισης: Λειτουργίες ρολοιού

Τρόπος ρύθμισης: Ώρα		
Βήμα 1	Βήμα 2	Βήμα 3
		
Για να αλλάξετε την ώρα, εισέλθετε στο μενού και επιλέξτε Ρυθμίσεις, Ώρα.	Ρυθμίστε το ρολόι.	Πατήστε: OK.

Τρόπος ρύθμισης: Χρονομετρητής			
Βήμα 1	Στην οθόνη εμφανίζεται η ένδειξη: 0:00 	Βήμα 2	Βήμα 3
			
Πιέστε: 	Ρυθμίστε τον Χρονομετρητή	Πατήστε: OK.	
 Ο χρονοδιακόπτης ξεκινά αμέσως την αντίστροφη μέτρηση.			

Τρόπος ρύθμισης: Χρόνος μαγειρέματος				
Βήμα 1	Βήμα 2	Στην οθόνη εμφανίζεται η ένδειξη: 0:00  STOP	Βήμα 3	Βήμα 4
				
Επιλέξτε πρόγραμμα και ρυθμίστε τη θερμοκρασία.	Πιέστε επανειλημμένα. 	Ρυθμίστε τον χρόνο μαγειρέματος.	Πατήστε: OK.	
 Ο χρονοδιακόπτης ξεκινά αμέσως την αντίστροφη μέτρηση.				

Τρόπος ρύθμισης: Καθυστέρηση Έναρξης

Βήμα 1	Βήμα 2		Βήμα 3	Βήμα 4		Βήμα 5	Βήμα 6
		Η οθόνη εμφανίζει: την ώρα  ΕΝΑΡ-ΞΗ			Στην οθόνη εμφανίζεται η ένδειξη:  ΔΙΑΚΟΠΗ		
Επιλέξτε το πρόγραμμα ζεστάματος.	Πιέστε επανειλημμένα. 		Ρυθμίστε την ώρα έναρξης.	Πατήστε: ΟΚ.		Ρυθμίστε την ώρα τέλους.	Πατήστε: ΟΚ.

 Ο χρονοδιακόπτης ξεκινά την αντίστροφη μέτρηση σε μια καθορισμένη ώρα έναρξης.

8. ΤΡΟΠΟΣ ΧΡΗΣΗΣ: ΑΞΕΣΟΥΑΡ

8.1 Εισαγωγή αξεσουάρ

Μια μικρή εγκοπή στο πάνω μέρος αυξάνει την ασφάλεια. Οι εγκοπές λειτουργούν και ως ασφάλειες ανατροπής. Το υπερυψωμένο πλαίσιο γύρω από τη σχάρα αποτρέπει την ολίσθηση των μαγειρικών σκευών από αυτήν.

Μεταλλική σχάρα:

Σπρώξτε τη σχάρα ανάμεσα στις ράβδους οδήγησης του στηρίγματος της σχάρας.

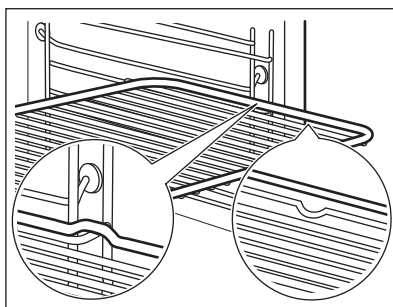

ΠΡΟΣΘΕΤΕΣ ΛΕΙΤΟΥΡΓΙΕΣ

Ταψί ψησίματος /Βαθύ ταψί:

Σπρώξτε το ταψί ανάμεσα στις ράβδους οδήγησης του στηρίγματος σχαρών.

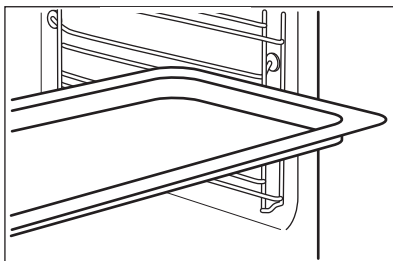

Μεταλλική σχάρα, Ταψί ψησίματος /Βαθύ ταψί:

Σπρώξτε το ταψί ανάμεσα στις ράβδους οδήγησης του στηρίγματος σχαρών και τη μεταλλική σχάρα στις επάνω ράβδους οδήγησης.

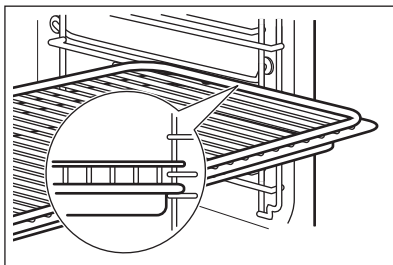

9. ΠΡΟΣΘΕΤΕΣ ΛΕΙΤΟΥΡΓΙΕΣ

9.1 Κλείδωμα

Αυτή η λειτουργία αποτρέπει την ακούσια αλλαγή της λειτουργίας φούρνου.

Ενεργοποιήστε όταν ο φούρνος βρίσκεται σε λειτουργία - το ρυθμισμένο πρόγραμμα συνεχίζει, ο πίνακας ελέγχου είναι κλειδωμένος.

Ενεργοποιήστε όταν ο φούρνος είναι απενεργοποιημένος - ο φούρνος δεν μπορεί να ενεργοποιηθεί, ο πίνακας ελέγχου είναι κλειδωμένος.



- πιέστε παρατεταμένα για να ενεργοποιήσετε τη λειτουργία. Ακούγεται ένα ηχητικό σήμα.





- πιέστε παρατεταμένα για να απενεργοποιηθεί.

① 3 x  - αναβοσβήνει όταν το κλείδωμα είναι ενεργοποιημένο.

9.2 Αυτόματη απενεργοποίηση

Για λόγους ασφαλείας, ο φούρνος απενεργοποιείται μετά από λίγη ώρα αν ένα πρόγραμμα ζεστάματος λειτουργεί και δεν αλλάξετε τις ρυθμίσεις.

 (°C)	 (ώ)
30 - 115	12.5
120 - 195	8.5
200 - 245	5.5
250 - μέγιστο	3

Η Αυτόματη απενεργοποίηση δεν λειτουργεί με τις λειτουργίες: Φωτισμός Φούρνου, Καθυστέρηση Έναρξης.

9.3 Ανεμιστήρας



Όταν λειτουργεί ο φούρνος, ο ανεμιστήρας ψύξης ενεργοποιείται αυτόματα για να διατηρούνται ψυχρές οι επιφάνειες του φούρνου. Εάν απενεργοποιήσετε τον φούρνο, ο ανεμιστήρας μπορεί να συνεχίσει να λειτουργεί μέχρι να κρυσώσει ο φούρνος.



10. ΥΠΟΔΕΪΞΕΙΣ ΚΑΙ ΣΥΜΒΟΥΛΕΣ

10.1 Υγρός Θερμός Αέρας

Για καλύτερα αποτελέσματα, ακολουθήστε τις προτάσεις που αναγράφονται στον παρακάτω πίνακα.

Χρησιμοποιήστε την τρίτη θέση σχάρας.

	 (°C)	 (min)
Ζυμαρικά Ωγκρατέν	200 - 220	45 - 55
Πατάτες Ωγκρατέν	180 - 200	70 - 85
Μουσακάς	170 - 190	70 - 95
Λαζάνια	180 - 200	75 - 90
Καννελόνια	180 - 200	70 - 85
Τάρτα με βάση το ψωμί	190 - 200	55 - 70
Ρυζόγαλο	170 - 190	45 - 60

	 (°C)	 (min)
Κέικ μήλου, φτιαγμένο με μείγμα αφράτου κέικ (στρογγυλή φόρμα για κέικ)	160 - 170	70 - 80
Λευκό ψωμί	190 - 200	55 - 70

10.2 Υγρός Θερμός Αέρας - προτεινόμενα αξεσουάρ







Χρησιμοποιείτε σκούρα και μη ανακλαστικά βαθιά ταψιά/φόρμες και δοχεία. Έχουν καλύτερη απορρόφηση θερμότητας από τα ανοιχτόχρωμα και ανακλαστικά σκεύη.

 Ταψί πίτσας	 Πυρίμαχο ταψί	 Κεραμικά φορμάκια	 Βαθύ ταψί/φόρμα βάσης τάρτας
Σκούρο, μη ανακλαστικό Διαμέτρου 28 cm	Σκούρο, μη ανακλαστικό Διαμέτρου 26 cm	Κεραμικό Διαμέτρου 8 cm, ύψους 5 cm	Σκούρο, μη ανακλαστικό Διαμέτρου 28 cm

10.3 Πίνακες μαγειρέματος για ινστιτούτα δοκιμών





Πληροφορίες για ινστιτούτα δοκιμών

Δοκιμές σύμφωνα με το: EN 60350, IEC 60350.

 ΨΗΣΙΜΟ ΣΕ ΕΝΑ ΕΠΙΠΕΔΟ. Ψήσιμο σε βαθιά ταψιά/φόρμες				
		 (°C)	 (ΛΕΠΤΑ)	
Αφράτο κέικ χωρίς λιπαρά	Θερμός Αέρας	140 - 150	35 - 50	2
Αφράτο κέικ χωρίς λιπαρά	Πάνω/Κάτω Θέρμανση	160	35 - 50	2



ΨΗΣΙΜΟ ΣΕ ΕΝΑ ΕΠΙΠΕΔΟ. Ψήσιμο σε βαθιά ταψιά/φόρμες





		 (°C)	 (ΛΕΠΤΑ)	
Μηλόπιτα, 2 φόρμες Ø20 cm	Θερμός Αέρας	160	60 - 90	2
Μηλόπιτα, 2 φόρμες Ø20 cm	Πάνω/Κάτω Θέρμανση	180	70 - 90	1



ΨΗΣΙΜΟ ΣΕ ΕΝΑ ΕΠΙΠΕΔΟ. Μπισκότα







Χρησιμοποιήστε την τρίτη θέση σχάρας.

		 (°C)	 (ΛΕΠΤΑ)
Μπισκ. Ζύμ. Κουρού / Ζύμη σε λωρίδες	Θερμός Αέρας	140	25 - 40
Μπισκ. Ζύμ. Κουρού / Ζύμη σε λωρίδες, προθερμάνετε τον άδειο φούρνο	Πάνω/Κάτω Θέρμανση	160	20 - 30
Μικρά κέικ, 20 τεμάχια/ταψί, προθερμάνετε τον άδειο φούρνο	Θερμός Αέρας	150	20 - 35
Μικρά κέικ, 20 τεμάχια/ταψί, προθερμάνετε τον άδειο φούρνο	Πάνω/Κάτω Θέρμανση	170	20 - 30

ΦΡΟΝΤΙΔΑ ΚΑΙ ΚΑΘΑΡΙΣΜΑ



ΨΗΣΙΜΟ ΣΕ ΠΟΛΛΑ ΕΠΙΠΕΔΑ. Μπισκότα

		 (°C)	 (ΛΕΠΤΑ)	
Μπισκ. Ζύμ. Κουρού / Ζύμη σε λωρίδες	Θερμός Αέρας	140	25 - 45	1 / 4
Μικρά κέικ, 20 τεμάχια/ταψί, προθερμάνετε τον άδειο φούρνο	Θερμός Αέρας	150	23 - 40	1 / 4
Αφράτο κέικ χωρίς λιπαρά	Θερμός Αέρας	160	35 - 50	1 / 4







ΓΚΡΙΛ



Προθερμάνετε τον άδειο φούρνο για 5 λεπτά.



Ψήνετε στο γκριλ με τη μέγιστη ρύθμιση θερμοκρασίας.

		 (ΛΕΠΤΑ)	
Τοστ	Γκριλ	1 - 3	5
Βοδινή μπριζόλα, γυρίστε από την άλλη πλευρά μόλις περάσει ο μισός χρόνος	Γκριλ	24 - 30	4

11. ΦΡΟΝΤΙΔΑ ΚΑΙ ΚΑΘΑΡΙΣΜΑ





ΠΡΟΕΙΔΟΠΟΙΗΣΗ!

Ανατρέξτε στα κεφάλαια σχετικά με την Ασφάλεια.

11.1 Σημειώσεις για τον καθαρισμό

 <p>Προϊόντα Καθαρισμού</p>	Καθαρίστε την πρόσοψη του φούρνου με ένα μαλακό πανί, ζεστό νερό και ένα ήπιο απορρυπαντικό.
	Χρησιμοποιήστε ένα διάλυμα καθαρισμού για να καθαρίσετε τις μεταλλικές επιφάνειες.
	Καθαρίστε τους λεκέδες με ένα ήπιο απορρυπαντικό.

 <p>Καθημερινή Χρήση</p>	Καθαρίζετε το εσωτερικό του φούρνου μετά από κάθε χρήση. Η συσσώρευση λίπους ή άλλων υπολειμμάτων μπορεί να προκαλέσει πυρκαγιά.
	Μην αποθηκεύετε φαγητό στον φούρνο για περισσότερο από 20 λεπτά. Σκουπίζετε το εσωτερικό του φούρνου με ένα μαλακό πανί μετά από κάθε χρήση.

 <p>Αξεσουάρ</p>	Καθαρίζετε όλα τα αξεσουάρ μετά από κάθε χρήση και αφήνετέ τα να στεγνώσουν. Χρησιμοποιείτε ένα μαλακό πανί, χλιαρό νερό και ένα ήπιο απορρυπαντικό. Μην καθαρίζετε τα αξεσουάρ σε πλυντήριο πιάτων.
	Μην καθαρίζετε τα αντικολητικά αξεσουάρ χρησιμοποιώντας ισχυρά καθαριστικά ή αιχμηρά αντικείμενα.

11.2 Τρόπος καθαρισμού: Ανάγλυφο τμήμα εσωτερικού του φούρνου

Καθαρίστε το ανάγλυφο τμήμα του εσωτερικού του φούρνου για να αφαιρέσετε κατάλοιπα αλάτων μετά το μαγείρεμα με ατμό.

Βήμα 1	Βήμα 2	Βήμα 3
Ρίξτε: 250 ml λευκό ξύδι στο ανάγλυφο τμήμα του εσωτερικού του φούρνου. Χρησιμοποιήστε ξύδι 6% χωρίς πρόσθετα.	Αφήστε το ξύδι να διαλύσει τα κατάλοιπα αλάτων σε θερμοκρασία περιβάλλοντος για 30 λεπτά.	Καθαρίστε το εσωτερικό του φούρνου με ζεστό νερό και μαλακό πανί.
Για τη λειτουργία: SteamBake καθαρίζετε τον φούρνο κάθε 5 - 10 κύκλους μαγειρέματος.		

11.3 Τρόπος αφαίρεσης: Στηρίγματα σαχρών

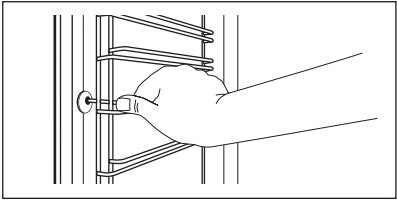
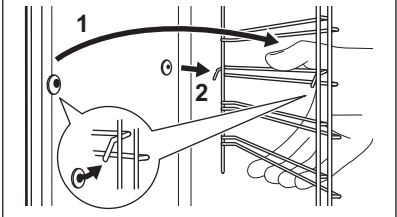

Αφαιρέστε τα στηρίγματα σαχρών για να καθαρίσετε τον φούρνο.

ΦΡΟΝΤΙΔΑ ΚΑΙ ΚΑΘΑΡΙΣΜΑ

Βήμα 1	Σβήστε τον φούρνο και περιμένετε να κρυώσει.	
Βήμα 2	Τραβήξτε το μπροστινό τμήμα του στηρίγματος σχαρών για να το αποσπάσετε από το πλαίσιο τοίχωμα.	
Βήμα 3	Τραβήξτε το πίσω άκρο του στηρίγματος σχαρών από το πλαίσιο τοίχωμα και αφαιρέστε το.	
Βήμα 4	Τοποθετήστε τα στηρίγματα σχαρών, ακολουθώντας την παραπάνω διαδικασία με την αντίστροφη σειρά. Οι πείροι στερέωσης των τηλεσκοπικών βραχιόνων πρέπει να είναι στραμμένοι προς τα εμπρός.	



11.4 Τρόπος χρήσης: Πυρολυτικός Καθαρισμός

Καθαρίστε τον φούρνο με Πυρολυτικός Καθαρισμός.

	ΠΡΟΕΙΔΟΠΟΙΗΣΗ! Υπάρχει κίνδυνος εγκαύματος.
	ΠΡΟΣΟΧΗ! Αν άλλες συσκευές έχουν εγκατασταθεί στο ίδιο ντουλάπι, μην τις χρησιμοποιείτε ταυτόχρονα με αυτήν τη λειτουργία. Μπορεί να προκληθεί ζημιά στον φούρνο.

Πριν από Πυρολυτικός Καθαρισμός:		
Σβήστε τον φούρνο και περιμένετε να κρυώσει.	Αφαιρέστε τα εξαρτήματα και τα αποσπώμενα στηρίγματα σχαρών.	Καθαρίστε το δάπεδο του φούρνου και το εσωτερικό τζάμι της πόρτας με ζεστό νερό, ένα μαλακό πανί και ένα ήπιο απορρυπαντικό.

Πυρολυτικός Καθαρισμός	
Βήμα 1	Είσοδος στο μενού: Καθαρισμός 
Επιλογή	Διάρκεια

Πυρολυτικός Καθαρισμός	
C1 - Ελαφρύς καθαρισμός	1 h
C2 - Κανονικός καθαρισμός	1 h 30 min
C3 - Σχολαστικός καθαρισμός	3 h
Βήμα 2	OK - πιέστε για να επιλέξετε το πρόγραμμα καθαρισμού.
Βήμα 3	OK - πιέστε για να ξεκινήσει ο καθαρισμός.
Βήμα 4	Μετά τον καθαρισμό, στρέψτε τον διακόπτη προγραμμάτων στη θέση απενεργοποίησης.
<p> Κατά τη διάρκεια του καθαρισμού, ο λαμπτήρας του φούρνου είναι σβηστός.</p> <p>Όταν ο φούρνος φτάσει στην καθορισμένη θερμοκρασία, η πόρτα ασφαλίζει. Μέχρι να ξεκλειδώσει η πόρτα, η οθόνη εμφανίζει: .</p>	

Όταν ολοκληρωθεί ο καθαρισμός:		
Σβήστε τον φούρνο και περιμένετε να κρυώσει.	Καθαρίστε το εσωτερικό του φούρνου με ένα μαλακό πανί.	Αφαιρέστε τα υπολείμματα από το κάτω μέρος του εσωτερικού του φούρνου.

11.5 Υπενθύμιση Καθαρισμού

Ο φούρνος σας υπενθυμίζει πότε να τον καθαρίσετε με πυρολυτικό καθαρισμό.	
Η ένδειξη  αναβοσβήνει στην οθόνη για 5 δευτ. μετά από κάθε μαγείρεμα.	Για να απενεργοποιήσετε την υπενθύμιση, εισέλθετε στο Μενού και επιλέξτε Ρυθμίσεις, Υπενθύμιση Καθαρισμού.

11.6 Τρόπος αφαίρεσης και τοποθέτησης: Πόρτα

Μπορείτε να αφαιρέσετε την πόρτα και τα εσωτερικά τζάμια για να τα καθαρίσετε. Ο αριθμός των τζαμιών διαφέρει ανάλογα με το μοντέλο.

 <p>ΠΡΟΕΙΔΟΠΟΙΗΣΗ! Η πόρτα είναι βαριά.</p>
--

ΦΡΟΝΤΙΔΑ ΚΑΙ ΚΑΘΑΡΙΣΜΑ



ΠΡΟΣΟΧΗ!

Μεταχειριστείτε προσεκτικά το τζάμι, ειδικά στις άκρες του μπροστινού τζαμιού. Το τζάμι μπορεί να σπάσει.

Βήμα 1	Ανοίξτε πλήρως την πόρτα.	
Βήμα 2	Ανασηκώστε και πιέστε τους μοχλούς σύσφιξης (A) στους δύο μεντεσέδες της πόρτας.	
Βήμα 3	Κλείστε την πόρτα του φούρνου μέχρι την πρώτη θέση ανοίγματος (σε γωνία περίπου 70°). Κρατώντας την πόρτα και από τις δύο πλευρές, τραβήξτε για να την αφαιρέσετε από τον φούρνο με γωνία προς τα πάνω. Τοποθετήστε την πόρτα επάνω σε ένα απαλό πανί και σε σταθερή επιφάνεια με την εξωτερική πλευρά προς τα κάτω.	
Βήμα 4	Κρατήστε το πλαίσιο της πόρτας (B) στο πάνω άκρο της πόρτας στις δύο πλευρές και σπρώξτε προς τα μέσα για να απασφαλιστεί το κλιπ.	
Βήμα 5	Τραβήξτε το πλαίσιο της πόρτας προς τα εμπρός για να το αφαιρέσετε.	
Βήμα 6	Κρατήστε τα τζάμια της πόρτας από το πάνω άκρο, ένα-ένα, και τραβήξτε τα προς τα πάνω, για να τα αφαιρέσετε από τον οδηγό.	
Βήμα 7	Καθαρίστε το τζάμι με νερό και σαπούνι. Σκουπίστε το τζάμι προσεκτικά. Μην πλένετε τα τζάμια στο πλυντήριο πιάτων.	
Βήμα 8	Μετά τον καθαρισμό, εκτελέστε τα παραπάνω βήματα με την αντίστροφη σειρά.	
Βήμα 9	Τοποθετήστε πρώτα το μικρότερο τζάμι και μετά το μεγαλύτερο και την πόρτα. Βεβαιωθείτε ότι τα τζάμια έχουν τοποθετηθεί στη σωστή θέση, διαφορετικά η επιφάνεια της πόρτας μπορεί να υπερθερμανθεί.	

11.7 Τρόπος αντικατάστασης: Λαμπτήρας



ΠΡΟΕΙΔΟΠΟΙΗΣΗ!

Κίνδυνος ηλεκτροπληξίας.
Ο λαμπτήρας μπορεί να είναι ζεστός.

Προτού αντικαταστήσετε τον λαμπτήρα:

Βήμα 1	Βήμα 2	Βήμα 3
Απενεργοποιήστε τον φούρνο. Περιμένετε να κρυώσει ο φούρνος.	Αποσυνδέστε τον φούρνο από το ρεύμα.	Τοποθετήστε ένα πανί στο κάτω μέρος του εσωτερικού του φούρνου.

Επάνω λαμπτήρας

Βήμα 1	Στρέψτε το γυάλινο κάλυμμα για να το αφαιρέσετε.	
Βήμα 2	Καθαρίστε το γυάλινο κάλυμμα.	
Βήμα 3	Αντικαταστήστε τον λαμπτήρα με κατάλληλο λαμπτήρα ανθεκτικό στη θερμότητα έως 300 °C.	
Βήμα 4	Τοποθετήστε το γυάλινο κάλυμμα.	

12. ΑΝΤΙΜΕΤΩΠΙΣΗ ΠΡΟΒΛΗΜΑΤΩΝ



ΠΡΟΕΙΔΟΠΟΙΗΣΗ!

Ανατρέξτε στα κεφάλαια σχετικά με την Ασφάλεια.

12.1 Τι να κάνετε αν...

Για περιπτώσεις που δεν περιλαμβάνονται σε αυτόν τον πίνακα, επικοινωνήστε με το Εξουσιοδοτημένο Κέντρο Σέρβις.



Ο φούρνος δεν ενεργοποιείται ή δεν θερμαίνεται

Πρόβλημα	Ελέγξτε εάν...
Δεν μπορείτε να ενεργοποιήσετε ή να λειτουργήσετε τον φούρνο.	Ο φούρνος είναι σωστά συνδεδεμένος στην ηλεκτρική παροχή.

ΑΝΤΙΜΕΤΩΠΙΣΗ ΠΡΟΒΛΗΜΑΤΩΝ



Ο φούρνος δεν ενεργοποιείται ή δεν θερμαίνεται

Ο φούρνος δεν προθερμαίνεται.	Έχει απενεργοποιηθεί η αυτόματη απενεργοποίηση.
Ο φούρνος δεν προθερμαίνεται.	Η πόρτα του φούρνου είναι κλειστή.
Ο φούρνος δεν προθερμαίνεται.	Δεν έχει καεί η ασφάλεια.
Ο φούρνος δεν προθερμαίνεται.	Είναι απενεργοποιημένο το «Κλειδ. ασφ. για παιδ.».



Εξαρτήματα

Πρόβλημα	Ελέγξτε εάν...
Ο λαμπτήρας είναι σβηστός.	Η λειτουργία Υγρός Θερμός Αέρας - είναι ενεργοποιημένη.
Ο λαμπτήρας δεν λειτουργεί.	Ο λαμπτήρας έχει καεί.



Κωδικόι σφάλματος

Στην οθόνη εμφανίζεται η ένδειξη...	Ελέγξτε εάν...
Err C3	Η πόρτα του φούρνου έχει κλείσει ή ο μηχανισμός κλειδώματος της πόρτας δεν έχει χαλάσει.
Err F102	Η πόρτα του φούρνου είναι κλειστή.
Err F102	Το κλειδωμα πόρτας δεν έχει χαλάσει.
0:00.	Υπήρξε μια διακοπή ρεύματος. Ρυθμίστε την ώρα.

Αν η οθόνη εμφανίζει έναν κωδικό σφάλματος που δεν βρίσκεται σε αυτόν τον πίνακα, απενεργοποιήστε και ενεργοποιήστε την ασφάλεια του σπιτιού για να κάνετε επανεκκίνηση στον φούρνο. Αν ο κωδικός σφάλματος επαναληφθεί, επικοινωνήστε με ένα Εξουσιοδοτημένο Κέντρο Σέρβις.



Καθαρισμός

Πρόβλημα	Ελέγξτε εάν...
Το νερό διαρρέει από το ανάγλυφο τμήμα του εσωτερικού του φούρνου.	Υπάρχει πάρα πολύ νερό στο ανάγλυφο τμήμα του εσωτερικού του φούρνου.

12.2 Δεδομένα Σέρβις

Εάν δεν μπορείτε να αντιμετωπίσετε το πρόβλημα μόνοι σας, επικοινωνήστε με τον αντιπρόσωπό μας ή το Εξουσιοδοτημένο Κέντρο Σέρβις.

Τα απαραίτητα στοιχεία για το κέντρο σέρβις βρίσκονται στην πινακίδα τεχνικών χαρακτηριστικών. Η πινακίδα τεχνικών χαρακτηριστικών βρίσκεται στο μπροστινό πλαίσιο στο εσωτερικό του φούρνου. Μην αφαιρείτε την πινακίδα τεχνικών χαρακτηριστικών από το εσωτερικό του φούρνου.

Σας συνιστούμε να σημειώσετε τα σχετικά στοιχεία εδώ:	
Μοντέλο (MOD.)
Κωδικός προϊόντος (PNC)
Αριθμός σειράς (S.N.)

13. ΕΝΕΡΓΕΙΑΚΉ ΑΠΌΔΟΣΗ

13.1 Πληροφορίες Προϊόντος και Φύλλο Πληροφοριών Προϊόντος*

Όνομα προμηθευτή	AEG
Αναγνωριστικό μοντέλου	BPB351160M 944188506 BPS351160M 944188507
Δείκτης Ενεργειακής Απόδοσης	81.2
Τάξη ενεργειακής απόδοσης	A+
Κατανάλωση ενέργειας με τυποποιημένο φορτίο, κατά τη συμβατική λειτουργία	1.09 kWh/κύκλο
Κατανάλωση ενέργειας με τυποποιημένο φορτίο, κατά τη λειτουργία με υποβοήθηση ανεμιστήρα	0.69 kWh/κύκλο

Πλήθος θαλάμων	1	
Πηγή θερμότητας	Ηλεκτρική ενέργεια	
Όγκος	71 l	
Τύπος φούρνου	Εντοιχιζόμενος Φούρνος	
Μάζα	BPB351160M	34.0 kg
	BPS351160M	34.0 kg

* Για την Ευρωπαϊκή Ένωση σύμφωνα με τους Κανονισμούς της ΕΕ 65/2014 και 66/2014. Για τη Δημοκρατία της Λευκορωσίας σύμφωνα με το πρότυπο STB 2478-2017, Παράρτημα G και το πρότυπο STB 2477-2017, Παράρτηματα A και B. Για την Ουκρανία σύμφωνα με τον κανονισμό 568/32020.

Η τάξη ενεργειακής απόδοσης δεν ισχύει για τη Ρωσία.

EN 60350-1 - Οικιακές ηλεκτρικές συσκευές μαγειρέματος - Μέρος 1: Μαγειρεία, φούρνοι, φούρνοι ατμού και γκριλ - Μέθοδοι μέτρησης της επίδοσης.

13.2 Εξοικονόμηση ενέργειας



Ο φούρνος διαθέτει δυνατότητες που συμβάλλουν στην εξοικονόμηση ενέργειας κατά τη διάρκεια του καθημερινού μαγειρέματος.

Βεβαιωθείτε ότι η πόρτα του φούρνου είναι κλειστή ενώ ο φούρνος βρίσκεται σε λειτουργία. Μην ανοίγετε την πόρτα του φούρνου συχνά κατά τη διάρκεια του μαγειρέματος. Διατηρείτε καθαρό το λάστιχο της πόρτας και βεβαιωθείτε ότι είναι καλά στερεωμένο στη θέση του.

Χρησιμοποιείτε μεταλλικά μαγειρικά σκεύη για να βελτιώσετε την εξοικονόμηση ενέργειας.

Όταν είναι εφικτό, μην προθερμαίνετε τον φούρνο πριν το μαγείρεμα.

Όταν μαγειρεύετε μερικά φαγητά τη φορά, μην αφήνετε να παρέλθει μεγάλο χρονικό διάστημα μεταξύ του ψησίματός τους.

Μαγείρεμα με αέρα

Όποτε είναι εφικτό, χρησιμοποιήστε τις λειτουργίες μαγειρέματος με αέρα για να εξοικονομήσετε ενέργεια.

Υπολειπόμενη θερμότητα

Ο ανεμιστήρας και ο λαμπτήρας εξακολουθούν να λειτουργούν. Όταν απενεργοποιείτε τον φούρνο, η οθόνη εμφανίζει την υπολειπόμενη θερμότητα. Μπορείτε να χρησιμοποιήσετε τη θερμότητα για να διατηρήσετε ζεστό το φαγητό.

Όταν η διάρκεια μαγειρέματος είναι μεγαλύτερη από 30 λεπτά, μειώστε τη θερμοκρασία του φούρνου στο ελάχιστο 3 - 10 λεπτά προτού ολοκληρωθεί το μαγείρεμα. Η υπολειπόμενη θερμότητα εσωτερικά του φούρνου θα συνεχίσει το μαγείρεμα.

Χρησιμοποιήστε την υπολειπόμενη θερμότητα για να ζεστάνετε άλλα φαγητά.

Διατήρηση της θερμοκρασίας του φαγητού

Επιλέξτε τη χαμηλότερη δυνατή ρύθμιση θερμοκρασίας για να χρησιμοποιήσετε την υπολειπόμενη θερμότητα και να διατηρήσετε ζεστό το φαγητό. Η ένδειξη υπολειπόμενης θερμότητας ή η θερμοκρασία εμφανίζεται στην οθόνη.

Μαγείρεμα με τον λαμπτήρα απενεργοποιημένο

Απενεργοποιήστε τον λαμπτήρα κατά τη διάρκεια του μαγειρέματος. Ανοίγετέ τον μόνο όταν τον χρειάζεστε.

Υγρός Θερμός Αέρας



Λειτουργία που σχεδιάστηκε για να εξοικονομείτε ενέργεια κατά το μαγείρεμα.





Όταν χρησιμοποιείτε αυτήν τη λειτουργία, ο λαμπτήρας απενεργοποιείται αυτόματα μετά από 30 δευτερόλεπτα. Μπορείτε να ανάψετε τον λαμπτήρα ξανά αλλά αυτή η ενέργεια θα μειώσει την προσδοκώμενη εξοικονόμηση ενέργειας.

14. ΔΟΜΉ ΜΕΝΟΥ

14.1 Μενού

	≡ - επιλέξτε για εισαγωγή του Μενού.
---	--------------------------------------



Μενού δομή		
Μαγείρεμα με βοήθεια 	Καθαρισμός 	Ρυθμίσεις 

Βήμα 1	Βήμα 2	Βήμα 3	Βήμα 4	Βήμα 5
 ≡ 	 OK	 O1 - O11	 OK	
Επιλέξτε το Μενού, Ρυθμίσεις.	Επιβεβαιώστε τη ρύθμιση.	Επιλέξτε τη ρύθμιση.	Επιβεβαιώστε τη ρύθμιση.	Ρυθμίστε την τιμή και πατήστε OK.

Ρυθμίσεις					
O1	Ωρα	Αλλαγή	O2	Φωτεινότητα Οθόνης	1 - 5
O3	Ήχοι Πλήκτρων	1 - Ηχητικό σήμα 2 - Κλικ 3 - Απενεργοποίηση ήχου	O4	Ένταση Βομβητή	1 - 4

Ρυθμίσεις					
05	Χρονοδιακόπτης λειτουργίας	Ενεργοποίηση / απενεργοποίηση	06	Φωτισμός Φούρνου	Ενεργοποίηση / απενεργοποίηση
07	Ταχεία προθέρμανση	Ενεργοποίηση / απενεργοποίηση	08	Υπενθύμιση Καθαρισμού	Ενεργοποίηση / απενεργοποίηση
09	Λειτουργία Demo	Κωδικός ενεργοποίησης: 2468	010	Έκδοση λογισμικού	Έλεγχος
011	Επαναφορά όλων των ρυθμίσεων	Ναι / Όχι			

15. ΠΕΡΙΒΑΛΛΟΝΤΙΚΑ ΘΕΜΑΤΑ

Ανακυκλώστε τα υλικά που φέρουν το σύμβολο . Τοποθετήστε τα υλικά συσκευασίας σε κατάλληλα δοχεία για ανακύκλωση. Συμβάλετε στην προστασία του περιβάλλοντος και της ανθρώπινης υγείας ανακυκλώνοντας τις άχρηστες ηλεκτρικές και ηλεκτρονικές συσκευές. Μην απορρίπτετε με τα οικιακά απορρίμματα συσκευές που φέρουν το σύμβολο . Επιστρέψτε το προϊόν στην τοπική σας μονάδα ανακύκλωσης ή επικοινωνήστε με τη δημοτική αρχή.

A TÖKÉLETES VÉGEREDMÉNY ÉRDEKÉBEN

Köszönjük, hogy ezt az AEG készüléket választotta. Termékünk gyártásakor egy olyan berendezést kívántunk megalkotni az Ön számára, amely kifogástalan teljesítményt nyújt hosszú éveken keresztül, köszönhetően az alkalmazott innovatív technológiáknak, amelyek az életét jelentősen megkönnyítik – és amelyeket más készülékeken nem talál meg. Kérjük, szánjon néhány percet az útmutató végigolvasására, hogy a maximumot hozhassa ki készülékéből.

Látogasson el weboldalunkra az alábbiakért:



Használattal kapcsolatos tanácsok, prospektusok, hibaelhárítási, szerviz- és javítási információk kérése:

www.aeg.com/support



Regisztrálja termékét a még kiválóbb szolgáltatásokért:

www.registreaeg.com



Tartozékok, segédanyagok és eredeti alkatrészek vásárlása a készülékhez:

www.aeg.com/shop



További receptekért, tippekért, hibaelhárítási segítségért töltsse le a **My AEG Kitchen** applikációt.



ÜGYFÉLSZOLGÁLAT ÉS SZERVIZ

Mindig eredeti cserealkatrészeket használjon.

Amikor felveszi a kapcsolatot a hivatalos szervizközponttal, gondoskodjon arról, hogy a következő adatok kéznél legyenek: Típus, PNC (termékszám), sorozatszám.

Az információk az adattáblán találhatóak.

Figyelem / Vigyázat – Biztonsági információk

Általános információk és tanácsok

Környezetvédelmi információk

A változtatások jogát fenntartjuk.

TARTALOM

1. BIZTONSÁGI INFORMÁCIÓK.....	220	2.5 Pírolitikus tisztítás.....	225
1.1 Gyermekek és fogyatékkal élő személyek biztonsága.....	221	2.6 Belső világítás.....	226
1.2 Általános biztonság.....	221	2.7 Szerviz.....	226
2. BIZTONSÁGI UTASÍTÁSOK.....	222	2.8 Ártalmatlanítás.....	226
2.1 Üzembe helyezés.....	222	3. TERMÉKLEÍRÁS.....	226
2.2 Elektromos csatlakozás.....	223	3.1 Általános áttekintés.....	227
2.3 Használat.....	224	3.2 Tartozékok.....	227
2.4 Ápolás és tisztítás.....	225		

4. A SÜTŐ BE- ÉS KIKAPCSOLÁSA.....	228	10.2 Konvekciós levegő (nedves) - ajánlott tartozékok.....	243
4.1 Visszahúzó gombok.....	228	10.3 Ét elkészítési táblázatok a bevizsgáló intézetek számára.....	243
4.2 Kezelőpanel.....	228	11. ÁPOLÁS ÉS TISZTÍTÁS.....	245
5. AZ ELSŐ HASZNÁLAT ELŐTT.....	229	11.1 Tisztítással kapcsolatos megjegyzések.....	246
5.1 Kezdeti tisztítás.....	229	11.2 Hogyan tisztítsa: Sütőtér mélyedése.....	246
5.2 Kezdeti előmelegítés.....	230	11.3 Hogyan távolítsa el: Polctartók.....	246
6. NAPI HASZNÁLAT.....	230	11.4 Hogyan használja: Pirolitikus tisztítás.....	247
6.1 Sütőfunkciók beállítása.....	230	11.5 Tisztítás emlékeztető.....	248
6.2 Sütőfunkciók.....	231	11.6 Eltávolítás és visszaszerelés: Ajtó.....	248
6.3 Megjegyzések a Konvekciós levegő (nedves) funkcióhoz.....	232	11.7 Hogyan cserélje: Lámpa.....	249
6.4 Előre programozott sütés beállítása.....	233	12. HIBAELHÁRÍTÁS.....	250
6.5 Előre programozott sütés receptekkel.....	233	12.1 Mi a teendő, ha.....	250
7. ÓRAFUNKCIÓK.....	238	12.2 A szerviz számára szükséges adatok.....	252
7.1 Órafunkciók.....	238	13. ENERGIAHATÉKONYSÁG.....	252
7.2 Órafunkciók beállítása.....	238	13.1 Termékre vonatkozó információk és Termékismertető*.....	252
8. HOGYAN HASZNÁLJA: TARTOZÉKOK.....	240	13.2 Energiatakarékosság.....	253
8.1 Tartozékok behelyezése.....	240	14. A MENÜ FELÉPÍTÉSE.....	253
9. TOVÁBBI FUNKCIÓK.....	241	14.1 Menü.....	253
9.1 Funkciózár.....	241		
9.2 Automatikus kikapcsolás.....	241		
9.3 Hűtőventilátor.....	242		
10. HASZNOS TANÁCSOK ÉS JAVASLATOK.....	242		
10.1 Konvekciós levegő (nedves).....	242		

1. BIZTONSÁGI INFORMÁCIÓK

Az üzembe helyezés és használat előtt gondosan olvassa el a mellékelt útmutatót. A gyártó nem vállal felelősséget a helytelen beszerelés vagy használat miatt keletkezett sérülésekért és károkért. Tartsa biztonságos és elérhető helyen az útmutatót, hogy szükség esetén mindig a rendelkezésére álljon.

1.1 Gyermekek és fogyatékkal élő személyek biztonsága

- Ezt a készüléket 8 év feletti gyermekek, csökkent fizikai, érzékelési vagy szellemi képességekkel rendelkező felnőttek, illetve megfelelő tudással vagy gyakorlattal nem rendelkező személyek csak felügyelet mellett, vagy abban az esetben használhatják, ha megfelelő oktatást kaptak a készülék biztonságos használatára, és megértik az esetleges veszélyeket. A 8 évesnél fiatalabb gyermekek, illetve a súlyos, komplex fogyatékkal élő személyek állandó felügyelet nélkül nem tartózkodhatnak a készülék közelében.
- Gondoskodni kell a gyermekek felügyeletéről, hogy ne játsszanak a készülékkel.
- Minden csomagolóanyagot tartson távol a gyermekektől, és megfelelően ártalmatlanítsa.
- FIGYELEM: A gyermekeket és kedvenc háziállatokat tartsa távol a készüléktől működés közben, és működés után, lehűléskor. Használat közben a készülék hozzáférhető részei felforrósodnak.
- Ha rendelkezik gyermekbiztonsági zárral a készülék, akkor azt be kell kapcsolni.
- Gyermekek felügyelet nélkül nem végezhetnek tisztítási vagy karbantartási tevékenységet a készüléken.

1.2 Általános biztonság

- A készülék üzembe helyezését és a hálózati kábel cseréjét csak képezített személy végezheti el.
- A bútorba való beépítés előtt ne használja a készüléket.
- Bármilyen karbantartás megkezdése előtt válassza le a készüléket az elektromos hálózatról.
- Ha a hálózati kábel megsérül, azt a gyártónak vagy a márkaszerviznek vagy más hasonlóan képzett személynek kell kicserélnie, nehogy elektromos veszélyhelyzet álljon elő.

BIZTONSÁGI UTASÍTÁSOK

- **FIGYELMEZTETÉS:** Az izzó cseréje előtt győződjön meg arról, hogy a készülék ki van kapcsolva, hogy megelőzze áramütést.
- **FIGYELMEZTETÉS:** Használat közben a készülék és az elérhető részek nagyon felforrósodhatnak. Legyen óvatos, hogy ne érjen a fűtőelemekhez.
- Amikor a sütőből kiveszi vagy behelyezi az edényeket, mindig használjon konyhai edényfogó kesztyűt.
- A polcvezető sín eltávolításához először a sín elejét, majd a hátulját húzza el az oldalfaltól. A polctartókat a kiszereléssel ellentétes sorrendben tegye vissza.
- A készülék tisztításához ne használjon nagy nyomású gőzt.
- Ne használjon súrolószert vagy éles fém kaparóeszközt a sütőajtó üvegének tisztítására, mivel ezek megkarcolhatják a felületet, ami az üveg megrepedését eredményezheti.
- A kiömlött anyagokat a pirolitikus tisztítás előtt el kell távolítani. Távolítsa el minden tartozékot a sütőből.

2. BIZTONSÁGI UTASÍTÁSOK

2.1 Üzembe helyezés



FIGYELMEZTETÉS!

A készüléket csak képesített személy helyezheti üzembe.

- Távolítsa el az összes csomagolóanyagot.
- Ne helyezzen üzembe, és ne is használjon sérült készüléket.
- Tartsa be a készülékhez mellékelt üzembe helyezési útmutatóban foglaltakat.
- A készülék nehéz, ezért legyen körültekintő a mozgatásakor. Mindig használjon munkavédelmi kesztyűt és zárt lábbelit.
- Soha ne húzza a készüléket a fogantyújánál fogva.
- A készüléket az üzembe helyezési követelményeknek megfelelő, biztonságos helyre telepítse.
- Tartsa meg a minimális távolságot a többi készüléktől és egységtől.
- A készülék felszerelése előtt ellenőrizze, hogy a sütő ajtaja akadálytalanul nyitható-e.
- A készülék elektromos hűtőrendszerrel van felszerelve. Ezt az elektromos tápegységgel kell működtetni.
- A beépíthető készüléknek meg kell felelnie a DIN 68930 stabilitási követelményeinek.

Konyhaszekrény minimális magassága (konyhaszekrény minimális magassága a munkalap alatt)	578 (600) mm
--	--------------

Konyhaszekrény szélessége	560 mm
Konyhaszekrény mélysége	550 (550) mm
Készülék elülső részének magassága	594 mm
Készülék hátulsó részének magassága	576 mm
Készülék elülső részének szélessége	595 mm
Készülék hátulsó részének szélessége	559 mm
Készülék mélysége	567 mm
Készülék beépített mélysége	546 mm
Mélység nyitott ajtónál	1027 mm
Szellőzőnyílás minimális mérete. A hátsó oldal alján elhelyezett nyílás	560 x 20 mm
Hálózati tápkábel hosszúsága. A kábel a hátsó oldal jobb sarkánál helyezkedik el	1500 mm
Rögzítőcsavarok	4 x 25 mm

2.2 Elektromos csatlakozás



FIGYELMEZTETÉS!

Tűz- és áramütésveszély.

- Minden elektromos csatlakoztatást szakképzett villanyszerelőnek kell elvégeznie.
- A készüléket kötelező földelni.
- Ellenőrizze, hogy az adattáblán szereplő adatok megfelelnek-e a helyi elektromos hálózat paramétereinek.
- Mindig megfelelően felszerelt, áramütés ellen védett aljzatot használjon.
- Ne használjon hálózati elosztókat és hosszabbító kábeleket.
- Ügyeljen a hálózati csatlakozódugó és a hálózati kábel épségére. Amennyiben a készülék hálózati vezetékét ki kell cserélni, a cserét márkaszervizünknel végeztesse el.
- Ügyeljen arra, hogy a hálózati kábelek ne kerüljenek közel, illetve ne érjenek hozzá a készülék ajtajához vagy a készülék alatti rekeszhez, különösen akkor, ha a készülék működik, vagy ajtaja forró.
- A feszültség alatt álló és szigetelt alkatrészek érintésvédelmi részeit úgy kell rögzíteni, hogy szerszám nélkül ne lehessen eltávolítani azokat.
- Csak az üzembe helyezés befejezése után csatlakoztassa a hálózati csatlakozódugót a hálózati csatlakozóaljzatba. Ügyeljen arra, hogy a hálózati dugasz üzembe helyezés után is könnyen elérhető legyen.

BIZTONSÁGI UTASÍTÁSOK

- Amennyiben a hálózati konnektor rögzítése laza, ne csatlakoztassa a csatlakozódugót hozzá.
- A készülék csatlakozásának bontására, soha ne a hálózati kábelnél fogva húzza ki a csatlakozódugót. A kábelt mindig a csatlakozódugónál fogva húzza ki.
- Kizárólag megfelelő szigetelőberendezést alkalmazzon: hálózati túlterhelésvédő megszakítót, biztosítékot (a tokból eltávolított csavaros típusú biztosítékot), földzárlatkioldót és védőrelét.
- Az elektromos készüléket szigetelőberendezéssel kell ellátni, amely lehetővé teszi, hogy minden fázison leválassza a készüléket az elektromos hálózatról. A szigetelőberendezésnek legalább 3 mm-es érintkezőtávolsággal kell rendelkeznie.
- Teljesen csukja be a készülék ajtaját, mielőtt csatlakoztatja a dugaszt a hálózati aljzatba.
- Ez a készülék hálózati csatlakozókábelrel és dugasszal kerül szállításra.

2.3 Használat



FIGYELMEZTETÉS!

Sérülés-, égés-, áramütés- és robbanásveszély.

- Ez a készülék kizárólag háztartási (beltéri) célokra használható.
- Ne változtassa meg a készülék műszaki jellemzőit.
- Ügyeljen arra, hogy a szellőzőnyílásokat ne zárja el semmi.
- Működés közben ne hagyja felügyelet nélkül a készüléket.
- Minden használat után kapcsolja ki a készüléket.
- Körültekintően járjon el, ha működés közben kinyitja a készülék ajtaját. Forró levegő távozhat a készülékből.
- Ne működtesse a készüléket nedves kézzel, vagy amikor az vízzel érintkezik.
- Ne gyakoroljon nyomást a nyitott ajtóra.
- Ne használja a készüléket munka- vagy tárolófelületként.
- Óvatosan nyissa ki a készülék ajtaját. Az alkoholtartalmú alkotóelemek alkoholos levegőelegyet hozhatnak létre.
- Ügyeljen arra, hogy szikra vagy nyílt láng ne legyen a készülék közelében, amikor kinyitja az ajtót.
- Ne tegyen gyúlékony anyagot vagy gyúlékony anyaggal szennyezett tárgyat a készülékbe, annak közelébe, illetve annak tetejére.



FIGYELMEZTETÉS!

A készülék károsodásának veszélye áll fenn.

- A zománc károsodásának vagy elszíneződésének megelőzéséhez:
 - ne tegyen edényt vagy egyéb tárgyat közvetlenül a készülék sütőterének aljára.
 - ne tegyen alufóliát közvetlenül a készülék sütőterének aljára.
 - ne engedjen vizet a forró készülékbe.
 - a főzés befejezése után ne tárolja a nedves edényeket vagy az ételt a készülékben.
 - a tartozékok kivételekor vagy berakásakor óvatosan járjon el.
- A zománc vagy rozsdamentes acél elszíneződése nincs hatással a készülék teljesítményére.
- A nagy nedvességtartalmú sütemények esetében mély tepsit használjon a sütéshez. A gyümölcsök leve maradandó foltokat ejtethet.
- A készülék kizárólag ételkészítési célra szolgál. Tilos bármilyen más célra, például helyiség fűtésére használni.
- Sütés közben a sütő ajtaját mindig tartsa csukva.

- Ha a készüléket bútorlap (pl. ajtó) mögött helyezi el, ügyeljen arra, hogy az ajtó soha ne legyen becsukva, amikor a készülék működik. A hő és a nedvesség felhalmozódhat a zárt bútorlap mögött, és ennek következtében károsodhat a készülék, a készülék borítása vagy a padló. Használat után ne csukja be addig a bútorlapot, míg a készülék teljesen le nem hűlt.

2.4 Ápolás és tisztítás



FIGYELMEZTETÉS!

Személyi sérülés, tűz vagy a készülék károsodásának veszélye áll fenn.

- Karbantartás előtt kapcsolja ki a készüléket, és húzza ki a hálózati csatlakozódugót a csatlakozóaljzatból.
- Ellenőrizze, hogy lehűlt-e a készülék. Máskülönben fennáll a veszély, hogy az üveglapok eltörnek.
- A sütőajtó sérült üveglapját haladéktalanul cserélje ki. Forduljon a márkaszervizhez.
- Legyen óvatos, amikor az ajtót leszereli a készülékről. Az ajtó nehéz!
- Rendszeresen tisztítsa meg a készüléket, hogy elkerülje a felület károsodását.
- A készüléket puha, nedves ruhával tisztítsa. Csak semleges tisztítószer használjon. Ne használjon súrolószert, súrolószivacsot, oldószert vagy fém tárgyat.
- Amennyiben sütőtisztító aeroszolt használ, tartsa be a tisztítószer csomagolásán feltüntetett biztonsági utasításokat.

2.5 Pirolitikus tisztítás



FIGYELMEZTETÉS!

Pirolitikus tisztítás üzemmódban sérülés/tűz/vegyianyag-kibocsátás (gázok) veszélye áll fenn.

- A Pirolitikus öntisztító funkció vagy az első használat előtt távolítsa el a sütőtérből az alábbiakat:
 - minden ételmaradványt, olaj- vagy zsírkömlést/lerakódást.
 - minden eltávolítható tárgyat (beleértve a termékhez mellékelt polcokat, vezetősíneket stb.), különösen a tapadásmentes felületű lábasokat, fazekakat, edényeket, tepsiket, tálkákat, konyhai eszközöket stb.
- Olvassa el a pirolitikus tisztítással kapcsolatos összes utasítást.
- A pirolitikus tisztítás alkalmazása közben tartsa távol a kiskorú a készüléktől. A készülék nagyon fellemelegszik, és forró levegőt bocsát ki az elülső szellőzőnyílásain keresztül.
- A pirolitikus tisztítás magas hőmérsékletű funkció, és működése során gázok szabadulhatnak fel az ételmaradványokból és a készülék szerkezeti anyagaiból, így a vásárlók számára nyomatékosan ajánlottak az alábbiak:
 - az egyes pirolitikus tisztítások során és után biztosítson megfelelő szellőzést.
 - az első, maximális hőfokú üzemeltetés közben és után biztosítson megfelelő szellőzést.
- Az emberekkel ellentétben egyes madarak és hullók kivételesen érzékenyek lehetnek a pirolitikus tűzhelyek tisztítási folyamata során kibocsátott gázokra.
 - Tartsa távol a háziállatokat (különösen a madarakat) a készülék közeléből a pirolitikus tisztítás során és után, és a legmagasabb hőmérséklet funkciót először csak megfelelően szellőző helyen használja.
- A kistestű háziállatok szintén igen érzékenyek lehetnek a pirolitikus tűzhely közelében fellépő hőmérséklet-ingadozásokra, amikor a tűzhely pirolitikus öntisztítást végez.

- A lábasok, fazekak, tepsik, konyhai eszközök stb. tapadásgátló bevonata károsodhat a tűzhelyek pirolitikus öntisztításának magas hőmérséklete miatt, és kibocsáthat kismértékben káros gázokat.
- A pirolitikus tűzhelyekből és ételmaradványokból felszabaduló gázok nem ártalmasak az emberi egészségre (ideértve a kiskorú és a gyógyászati kezelés alatt álló személyeket is).

2.6 Belső világítás



FIGYELMEZTETÉS!

Vigyázat! Áramütés-veszély!

- A termékben található izzó(k)ra és a külön kapható pótizzókra vonatkozó tudnivalók: Ezek az izzók arra készültek, hogy megfeleljenek a háztartási készülékekben fennálló szélsőséges fizikai feltételeknek, mint például hőmérséklet, rezgés, magas páratartalom, illetve arra használatosak, hogy jelezzék a készülék működési állapotát. Nem alkalmasak egyéb felhasználásra, valamint helyiségek megvilágítására.
- Kizárólag az eredetivel megegyező műszaki jellemzőkkel rendelkező lámpát használjon.

2.7 Szerviz

- A készülék javítását bízza a márkaszervizre.
- Csak eredeti pótalkatrészeket használjon.

2.8 Ártalmatlanítás



FIGYELMEZTETÉS!

Sérülés- vagy fulladásveszély.

- Válassza le a készüléket az elektromos hálózatról.
- A készülék közelében vágja át a hálózati kábelt, és tegye a hulladékba.
- Szerelje le az ajtókilincset, hogy megakadályozza gyermekek vagy kedvenc állatok készülékben rekedését.

3. TERMÉKLEÍRÁS

3.1 Általános áttekintés

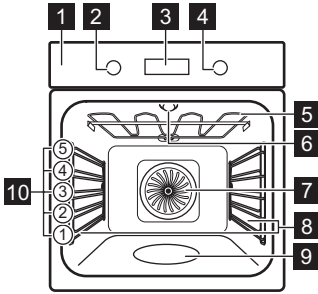

- 1** Kezelőpanel
- 2** Sütőfunkciók szabályozógombja
- 3** Kijelző
- 4** Szabályozó gomb
- 5** Fűtőbetét
- 6** Lámpa
- 7** Ventilátor
- 8** Polctartó, eltávolítható
- 9** Polcpozíciók
- 10** Sütőtér mélyedése

3.2 Tartozékok

Sütőrács

Főzőedényekhez, tortaformákhoz, valamint hűssütéshez.

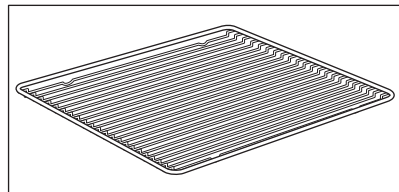

Sütő tálca

Tortákhoz és süteményekhez.

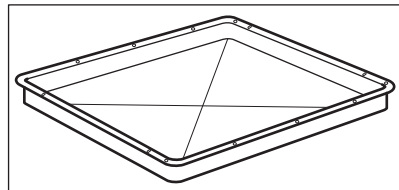

A SÜTŐ BE- ÉS KIKAPCSOLÁSA

Mély tepszi

Sütemények és húsok sütéséhez, illetve zsírfelfogó edényként.

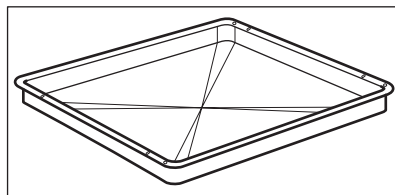

Teleszkópos sínek

A tepsik és huzalpolcok könnyebb behelyezéséhez és eltávolításához.

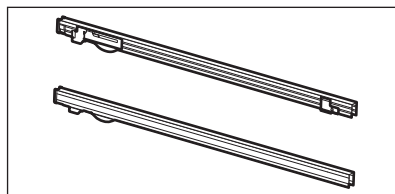







4. A SÜTŐ BE- ÉS KIKAPCSOLÁSA

4.1 Visszahúzható gombok

A készülék használatához nyomja meg a gombot. A gomb kiugrik.

4.2 Kezelőpanel

Kezelőpanel érzékelőmezői					Nyomja meg	Forgassa el a gombot
 Időzítő	 Gyors fel- fűtés	 Sütő világ- ítás	 Funkciózár	OK		

Válasszon ki egy sütőfunkciót a sütő bekapcsolásához.

A sütő kikapcsolásához fordítsa a sütőfunkciók gombját kikapcsolt helyzetbe.

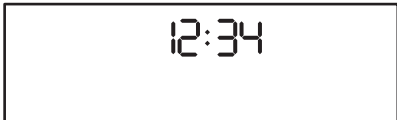
	Amikor a sütőfunkciók gombját kikapcsolt helyzetbe forgatja, a kijelző készenléti állapotba lép.
---	--

AZ ELSŐ HASZNÁLAT ELŐTT

	<p>Főzéskor a kijelző megjeleníti a beállított hőmérsékletet, a pontos időt és az egyéb rendelkezésre álló kiegészítő funkciókat.</p>
	<p>A kijelző a maximális számú beállított funkcióval.</p>

Kijelző visszajelzői

Funkciózár	Előre programozott sütés	Tisztítás	Beállítások	Gyors felfűtés
Időzítő visszajelzői:				

Folyamatjelző sáv - a hőmérséklet és az idő számára.	
--	--

Gőzben főzés visszajelző	
--------------------------	--

5. AZ ELSŐ HASZNÁLAT ELŐTT

	<p>FIGYELMEZTETÉS! Lásd a „Biztonság” című fejezetet.</p>
--	--

5.1 Kezdeti tisztítás



Az első használat előtt tisztítsa meg az üres sütőt, majd állítsa be a pontos időt:			
			<p>00:00 érték látható Állítsa be az időt. Nyomja meg ezt: OK.</p>

NAPI HASZNÁLAT

5.2 Kezdeti előmelegítés



Az első használat előtt hevítse fel az üres sütőt.

- | | |
|-----------------|---|
| 1. lépés | Vegyen ki a sütőből minden tartozékot és kivehető polctartót. |
| 2. lépés | Állítsa be a maximális hőmérséklet ennél a funkciónál: 
Hagyja egy óráig működni a sütőt. |
| 3. lépés | Állítsa be a maximális hőmérséklet ennél a funkciónál: 
Hagyja 15 percig működni a sütőt. |

 Előfűtés közben szagot és füstöt bocsáthat ki a sütő. Ügyeljen arra, hogy a helyiség szellőztetve legyen.

6. NAPI HASZNÁLAT







FIGYELMEZTETÉS!

Lásd a „Biztonság” című fejezetet.

6.1 Sütőfunkciók beállítása

Főzés elindítása





1. lépés	2. lépés
 	 
Állítson be egy sütőfunkciót.	Állítsa be a hőmérsékletet.

Gőzöléses főzés

Ellenőrizze, hogy lehűlt-e a sütő.

1. lépés	2. lépés	3. lépés	4. lépés
----------	----------	----------	----------

Gőzöléses főzés



	 	 	<p>Melegítse elő az üres sütőt 10 per- cig, hogy párá- t hozzon létre. Tegye az ételt sü- tőbe.</p>
<p>Csapvízzel töltsse fel a sütőtér mélye- dését.</p>	<p>Állítsa be a gő- zölés sütőfunk- ciót.</p>	<p>Állítsa be a hőmérsékle- tet.</p>	
<p>i A sütőtér mélyedésének maximális úrtartalma 250 ml. Ne töltsön vizet a sütőtér mélyedésébe sütés közben, vagy amikor a sütő forró.</p>			









Amikor a gőzben sütés befejeződik:

1. lépés	2. lépés	3. lépés
<p>A sütő kikapcsolásához for- dítsa a sütőfunkciók gombját kikapcsolt helyzetbe.</p>	<p>Óvatosan nyissa ki az ajtót. A kiszabaduló pára égési sérülést eredményezhet.</p>	<p>Ellenőrizze, hogy lehült-e a sütő. Távolítsa el a sütőtér bemélyedéséből a maradék vizet.</p>

6.2 Sütőfunkciók

Hagyományos sütőfunkciók

Sütőfunkció	Alkalmazás
 <p>Hőlégbefúvás, nagy hőfok</p>	<p>Sütés egyszerre maximum három sütőszinten, illetve aszalás. 20 - 40 °C- kal alacsonyabbra állítsa be a hőmérsékletet, mint Alsó + felső sütés ese- tén.</p>
 <p>Alsó + felső sütés</p>	<p>Egy sütőszinten történő sütéshez, valamint pörköléshez.</p>

Sütőfunkció	Alkalmazás
 <p>SteamBake</p>	Nedvesség hozzáadása a sütés során. Megfelelő szín és ropogós kéreg elérése sütés közben. Újramelegítéskor szaftosabb állag elérése. Gyümölcsök vagy zöldségek tartósításához.
 <p>Pizza funkció</p>	Pizza sütéséhez. Intenzív pirításhoz és ropogós aljú ételek készítéséhez.
 <p>Alsó sütés</p>	Ropogós aljú sütemények készítéséhez és étel tartósításához.
 <p>Fagyasztott ételek</p>	Készételek (pl. sült burgonya, steak burgonya vagy tavaszi tekercs) ropogóssá tételéhez.
 <p>Konvekciós levegő (nedves)</p>	A funkciót arra tervezték, hogy energiát takarítson meg a főzés során. A funkció használatakor a sütőtér hőmérséklete eltérhet a beállított hőmérséklettől. A készülék a maradékhőt használja fel. A fűtési teljesítmény lecsökkenhet. További tudnivalóként olvassa el a „Napi használat” c. fejezetben ezt a részt; Megjegyzések: Konvekciós levegő (nedves) funkciót.
 <p>Grill</p>	Vékony szelet élelmiszerek grillezéséhez és pirítás készítéséhez.
 <p>Infrasütés</p>	Nagy sült húsdarabok vagy nem kicsontozott szárnyas sütéséhez egy polcszinten. Csőben sütéshez és pirításhoz.
 <p>Menü</p>	Belépés a Menübe: Előre programozott sütés, Tisztítás, Beállítások.

6.3 Megjegyzések a Konvekciós levegő (nedves) funkcióhoz





A funkció megfelel az EU 65/2014 és EU 66/2014 sz. szabványok szerinti energiahatékonysági besorolásnak és ökológiai kialakításra vonatkozó követelményeknek. Vizsgálati módszerek az EN 60350-1 szabványnak megfelelően.

A sütőajtót sütés közben be kell csukni, hogy a funkció ne legyen megszakítva, és hogy a sütő a lehető legnagyobb energiahatékonysággal működjön.



A funkció használatakor a sütővilágítás 30 másodperc elteltével automatikusan kikapcsol. Főzési útmutatásokért olvassa el a „Hasznos tanácsok és javaslatok” című fejezetet, Konvekciós levegő (nedves). Általános energiatakarékosági javaslatokért olvassa el az „Energiahatékonyság” fejezet Energiatakarékoság c. részét.

6.4 Előre programozott sütés beállítása



Az almenüben szereplő összes ételhez van javasolt funkció és hőmérséklet. Főzés közben módosíthatja az időt és a hőmérsékletet.

Előre programozott sütés - használja az étel gyors elkészítéséhez az alapértelmezett beállításokkal:			
1. lépés	2. lépés	3. lépés	4. lépés
			
Lépjön be a menübe.	Válassza a Előre programozott sütés funkciót, majd nyomja meg a OK gombot.	Válassza ki az ételt. Nyomja meg ezt: OK.	Helyezze az ételt a sütőbe. Erősítse meg a beállítást.







6.5 Előre programozott sütés receptekkel

Magyarázat	
	A Gőzölés funkcióhoz szükséges vízmennyiség.
	Sütés előtt melegítse elő a sütőt.
	Polcszint.

Amikor a funkció véget ért, ellenőrizze, hogy elkészült-e az étel.





















	Étel	Tömeg	Polcszint / tartozék	Időtartam
Marha 				
P1	Marhasült, véresen	1 - 1,5 kg; 4 - 5 cm vastag darabok	 2; sütő tálca A húst néhány percig süsse elő serpenyőben. Helyezze a sütőbe.	40 perc
P2	Marhasült, közepes			50 perc
P3	Marhasült, jól átsütve			60 perc





















NAPI HASZNÁLAT

	Étel	Tömeg	Polcsint / tartozék	Időtartam
P4	Steak, közepes	180 - 220 g-os darabok; 3 cm vastag szeletek	  3; sütőedény a huzalpolcon A húst néhány percre süsse elő serpenyőben. Helyezze a sütőbe.	15 perc
P5	Marhahús sült / párolt (minőségi karaj, felső kerekpecsenye, vastag dagadó)	1,5 - 2 kg	 2; sütőedény a huzalpolcon A húst néhány percre süsse elő serpenyőben. Öntsön hozzá folyadékot. Helyezze a sütőbe.	120 perc
P6	Marhasült, véres (hőlégbefűtés, kis hőfok)	1 - 1,5 kg; 4 - 5 cm vastag darabok	 2; sütő tálca Használja kedvenc fűszereit, vagy csak egyszerűen sózza, és szórja meg frissen őrölt borssal. A húst néhány percre süsse elő serpenyőben. Helyezze a sütőbe.	75 perc
P7	Marhasült, közepes (hőlégbefűtés, kis hőfok)			85 perc
P8	Marhasült, jól átsütve (hőlégbefűtés, kis hőfok)			130 perc
P9	Filé, véres (hőlégbefűtés, kis hőfok)	0,5 - 1,5 kg; 5 - 6 cm vastag darabok	 2; sütő tálca Használja kedvenc fűszereit, vagy csak egyszerűen sózza, és szórja meg frissen őrölt borssal. A húst néhány percre süsse elő serpenyőben. Helyezze a sütőbe.	75 perc
P10	Filé, közepes (hőlégbefűtés, kis hőfok)			90 perc
P11	Filé, jól átsütve (hőlégbefűtés, kis hőfok)			120 perc
Borjú 				
P12	Borjú sült (pl. lapocka)	0,8 - 1,5 kg; 4 cm vastag darabok	 2; sütőedény a huzalpolcon Használja kedvenc fűszereit. Öntsön hozzá folyadékot. Lefedve süsse.	80 perc











	Étel	Tömeg	Polcsint / tartozék	Időtartam
Sertés 🍖 🍷				
P13	Sertés sült tarja vagy lapocka	1,5 - 2 kg	☐ 2; sütőedény a huzalpolcon A sütés félidejében fordítsa meg a húst.	120 perc
P14	Ropogósra pirított sertés, LTC	1,5 - 2 kg	☐ 2; sütő tálca Használja kedvenc fűszereit. A sütés félidejében fordítsa meg a húst, hogy egyenletesen piruljon.	215 perc
P15	Karaj, friss	1 - 1,5 kg; 5 - 6 cm vastag darabok	☐ 2; sütőedény a huzalpolcon Használja kedvenc fűszereit.	55 perc
P16	Karaj	2 - 3 kg; nyers, 2 - 3 cm vastag karaj	☐ 3; mély tepsi Adjon hozzá annyi folyadékot, hogy befedje az edény alját. A sütés félidejében fordítsa meg a húst.	90 perc
Bárány 🍗				
P17	Csontos báránycomb	1,5 - 2 kg; 7 - 9 cm vastag darabok	☐ 2; sütőedény a sütő tálcán Öntsön hozzá folyadékot. A sütés félidejében fordítsa meg a húst.	130 perc
Szárnyasok 🐔				
P18	Egész csirke	1 - 1,5 kg; friss	☐ 2; 🍷 200 ml; tűzálló edény a sütő tálcán Használja kedvenc fűszereit. A sütés félidejében fordítsa meg a csirkét, hogy egyenletesen piruljon.	60 perc
P19	Fél csirke	0,5 - 0,8 kg	☐ 3 ; sütő tálca Használja kedvenc fűszereit.	40 perc
P20	Jércemell	180 - 200 g-os darabok	☐ ☐ 2; tűzálló edény a huzalpolcon Használja kedvenc fűszereit. A húst néhány percig süsse elő serpenyőben.	25 perc

NAPI HASZNÁLAT

	Étel	Tömeg	Polcsint / tartozék	Időtartam
P21	Csirkecomb, friss	-	 3; sütő tálca Ha a csirkecombokat marinálta először, csökkentse a hőmérsékletet, és hosszabb ideig főzze őket.	30 perc
P22	Kacsa egészben	2 - 3 kg	 2; sütőedény a huzalpolcon Használja kedvenc fűszereit. Helyezze a húst a sütőedénybe. A sütés félidejében fordítsa meg a kacsát.	100 perc
P23	Liba egészben	4 - 5 kg	 2; mély tepszi Használja kedvenc fűszereit. Helyezze a húst a mély hússütő tepsibe. A sütés félidejében fordítsa meg a libát.	110 perc
Egyéb 				
P24	Fasírt	1 kg	 2; huzalpolc Használja kedvenc fűszereit.	60 perc
 Hal				
P25	Hal egészben, grillezve	0,5 - 1 kg halanként	 2 ; sütő tálca Töltse meg a halat vajjal, és használja kedvenc fűszereit.	30 perc
P26	Halfilé	-	  3; tűzálló edény a huzalpolcon Használja kedvenc fűszereit.	20 perc
Édes felfújtak / desszertek   				
P27	Sajttorta	-	 2;  28 cm-es, rugós sütőforma a huzalpolcon	90 perc
P28	Almatorta	-	 2;  100 - 150 ml; sütő tálca	60 perc
P29	Almás pite	-	 2; piteforma a huzalpolcon	40 perc
P30	Almáspite	-	 2;  100 - 150 ml;  22 cm-es piteforma a huzalpolcon	60 perc





	Étel	Tömeg	Polcsint / tartozék	Időtartam
P31	Csokoládés sütik	2 kg	 3; mély tepsi	30 perc
P32	Csokoládés muffin	-	 2;  100 - 150 ml; muffinsütő tepsi a huzalpolcon	30 perc
P33	Veknis sütemény	-	 2; kenyérsütő forma a huzalpolcon	50 perc
Zöldséges ételek / köretek   				
P34	Tepsis burgonya	1 kg	 2; sütő tálca Helyezze az egész, héjas burgonyákat a sütő tálcára.	50 perc
P35	Hasábburgonya	1 kg	 3; sütő tálca sütőpapírral bélelve Használja kedvenc fűszereit. Darabolja fel a burgonyákat.	35 perc
P36	Grillezett vegyes zöldség	1 - 1,5 kg	 3; sütő tálca sütőpapírral bélelve Használja kedvenc fűszereit. Darabolja fel a zöldségeket.	30 perc
P37	Krokkett, gyorsfagyasztott	0,5 kg	 3; sütő tálca	25 perc
P38	Hasábburgonya, gyorsfagyasztott	0,75 kg	 3; sütő tálca	25 perc
Felfújtak, kenyér és pizza   				
P39	Lasagna / Nudlifelfújt	1 - 1,5 kg	 2; tűzálló edény a huzalpolcon	45 perc
P40	Burgonyafelfújt	1 - 1,5 kg	 1; tűzálló edény a huzalpolcon	50 perc
P41	Pizza friss, vékony	-	  2;  100 ml; sütő tálca sütőpapírral bélelve	15 perc

ÓRAFUNKCIÓK

	Étel	Tömeg	Polcszint / tartozék	Időtartam
P42	Pizza friss, vastag	-	  2;  100 ml; sütő tálca sütőpapírral béleelve	25 perc
P43	Quiche	-	 2; sütés sütőformában a huzalpolcon	45 perc
P44	Bagett / Ciabatta / Fehér kenyér	0,8 kg	  3;  150 ml; sütő tálca sütőpapírral béleelve A fehér kenyérhez több idő szükséges.	30 perc
P45	Teljes kiőrlésű / rizs / barna kenyér kenyérsütő formában	1 kg	  2;  150 ml; sütő tálca sütőpapírral béleelve / huzalpolc	45 perc

7. ÓRAFUNKCIÓK



7.1 Órafunkciók

Órafunkció	Alkalmazás
	Percszámláló. Amikor az időzítés véget ér, hangjelzés hallható.
	Főzési idő. Amikor az időzítés véget ér, hangjelzés hallható, és a sütő-funkció leáll.
	Késleltetési idő. A sütés elindításának és / vagy befejezésének késleltetése.
	Működésidőzítő. Legfeljebb 23 ó 59 perc. Ez a funkció nincs hatással a sütő működésére. A Működésidőzítő funkció be- és kikapcsolásához válassza az alábbiakat: Menü, Beállítások.







7.2 Órafunkciók beállítása

Hogyan állítsa be: Pontos idő		
1. lépés	2. lépés	3. lépés







Hogyan állítsa be: Pontos idő

		
Az idő módosításához lépjen a menübe, majd válassza ki a Beállításokban a Pontos idő lehetőséget.	Állítsa be az órát.	Nyomja meg: OK funkciót.











Hogyan állítsa be: Percszámláló

1. lépés		2. lépés	3. lépés
	A kijelzőn a következő látható: 0:00 érték látható. 		
Nyomja meg:  funkciót.		Állítsa be Percszámláló értékét.	Nyomja meg: OK funkciót.
A  időzítő azonnal megkezdi a visszaszámlálást.			

Hogyan állítsa be: Főzési idő

1. lépés	2. lépés		3. lépés	4. lépés
		A kijelzőn a következő látható: 0:00 érték látható.  STOP		
Válassza ki a sütőfunkciót, majd állítsa be a hőmérsékletet.	Nyomja meg többször a következőt:  funkciót.		A sütési idő beállítása.	Nyomja meg: OK funkciót.
A  időzítő azonnal megkezdi a visszaszámlálást.				

HOGYAN HASZNÁLJA: TARTOZÉKOK

Hogyan állítsa be: Késletetési idő							
1. lépés	2. lépés		3. lépés	4. lépés		5. lépés	6. lépés
		A kijelző az új pontos időt mutatja.  START			A kijelzőn a következő látható: --:--  LEÁLLÍTÁS		
Válassza ki a sütőfunkciót.	Nyomja meg többször a következő funkciót.  funkciót.		Állítsa be az elindítás időpontját.	Nyomja meg: OK funkciót.		Állítsa be a befejezés időpontját.	Nyomja meg: OK funkciót.
A  időzítő a kezdés beállított időpontjában megkezdí a visszaszámlálást.							

8. HOGYAN HASZNÁLJA: TARTOZÉKOK

8.1 Tartozékok behelyezése

A felül található mélyedés a biztonságot növeli. Ezek a mélyedések megakadályozzák a megbillenést. A polc körüli magas perem megakadályozza a főzőedény lecsúszását a polcról.

Sütőrács:



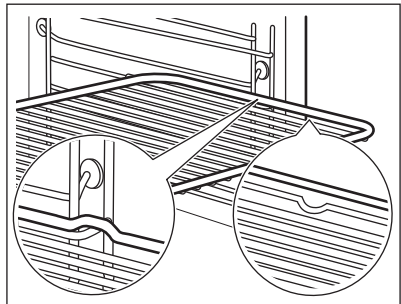

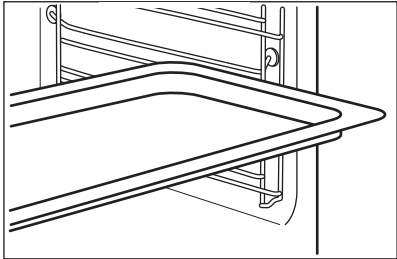
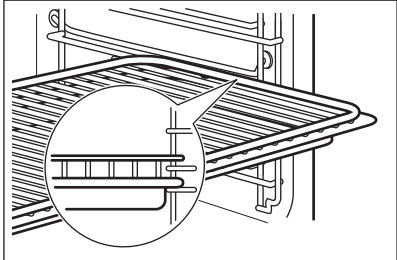
Csúsztassa be a huzalpolcot a polcvezető sínek közé, .



<p>Sütő tálca /Mély tepsí: Csúsztassa be a tálcat a polcvezető sínek közé.</p>	
<p>Sütőrács, Sütő tálca /Mély tepsí: Tolja a tálcat a polctartó vezetősinjei és a vezetősinék feletti huzalpolc közé.</p>	

9. TOVÁBBI FUNKCIÓK



9.1 Funkciózár

<p>Ez a funkció megakadályozza a sütőfunkció véletlen módosítását.</p>		
<p>Ha a sütő működése közben kapcsolja be, a beállított sütés tovább folytatódik, azonban a kezelőpanel lezár. Ha kikapcsolt sütőnél kapcsolja be, a sütő bekapcsolása nem lesz lehetséges, mivel a kezelőpanel lezár.</p>		
	<p>Nyomja meg és tartsa nyomva a  gombot a funkció bekapcsolásához. Hangjelzés hallható.</p>	<p> - nyomja meg és tartsa nyomva a kikapcsoláshoz.</p>
<p> 3 x  felvillanás jelzi a lezárás bekapcsolását.</p>		

9.2 Automatikus kikapcsolás

Biztonsági okokból a sütő bizonyos idő elteltével kikapcsol, ha egy sütőfunkció működik, és a kezelő nem változtat semmilyen beállításon.

HASZNOS TANÁCSOK ÉS JAVASLATOK

 (°C)	 (ó)
30 - 115	12.5
120 - 195	8.5
200 - 245	5.5
250 - maximum	3

Az Automatikus kikapcsolás nem működik az alábbi funkciókkal: Sütő világítás, Késletelési idő.



9.3 Hűtőventilátor



Amikor a sütő üzemel, a hűtőventilátor automatikusan bekapcsol, hogy hidegen tartsa a sütő felületét. Amikor kikapcsolja a sütőt, a hűtőventilátor továbbra is működni fog, amíg a sütő le nem hűl.

10. HASZNOS TANÁCSOK ÉS JAVASLATOK

10.1 Konvekciós levegő (nedves)

A legjobb eredmény érdekében használja az alábbi táblázatban szereplő ajánlásokat. A harmadik polcszintet használja.

	 (°C)	 (perc)
Tészta felfűjt	200 - 220	45 - 55
Burgonyafelfűjt	180 - 200	70 - 85
Muszaka	170 - 190	70 - 95
Lasagne	180 - 200	75 - 90
Cannelloni	180 - 200	70 - 85
Kenyérpuding	190 - 200	55 - 70
Rizspuding	170 - 190	45 - 60
Kevert piskótatésztából készült almatorta (ke-rek sütőformában)	160 - 170	70 - 80

	 (°C)	 (perc)
Fehér kenyér	190 - 200	55 - 70

10.2 Konvekciós levegő (nedves) - ajánlott tartozékok







Használjon sötét, nem visszatükröző felületű tepsiket és edényeket. Ezek jobb hőelnyerő képességűek, mint a világos színű és visszatükröző felületű edények.

 Pizzaszerpenyő	 Sütőedény	 Bögrés sütemény	 Tortasütő forma
Sötét, nem visszatükröző felülettel 28 cm-es átmérő	Sötét, nem visszatükröző felülettel 26 cm-es átmérő	Kerámia 8 cm-es átmérő, 5 cm magasság	Sötét, nem visszatükröző felülettel 28 cm-es átmérő

10.3 Ételkészítési táblázatok a bevizsgáló intézetek számára

Tájékoztató a bevizsgáló intézetek számára





Vizsgálati módszerek az alábbi szabványoknak megfelelően: EN 60350, IEC 60350.

 SÜTÉS EGY SZINTEN. Sütés sütőformákban				
		 (°C)	 (perc)	
Piskótateszta (zsiradék nélkül)	Hőlégbefűtés, nagy hőfok	140 - 150	35 - 50	2
Piskótateszta (zsiradék nélkül)	Alsó + felső sütés	160	35 - 50	2
Almáspite, 2 forma, átmérő: 20 cm	Hőlégbefűtés, nagy hőfok	160	60 - 90	2

HASZNOS TANÁCSOK ÉS JAVASLATOK



SÜTÉS EGY SZINTEN. Sütés sütőformákban





		 (°C)	 (perc)	
Almáspite, 2 forma, átmérő: 20 cm	Alsó + felső sütés	180	70 - 90	1



SÜTÉS EGY SZINTEN. Teasütemény







A harmadik polcszintet használja.

		 (°C)	 (perc)
Linzer / Omlós tészták	Hőlégbefűtés, nagy hőfok	140	25 - 40
Linzer / Omlós tészták, melegítse elő az üres sütőt	Alsó + felső sütés	160	20 - 30
Aprósütemény, 20 db/tepsi, melegítse elő az üres sütőt	Hőlégbefűtés, nagy hőfok	150	20 - 35
Aprósütemény, 20 db/tepsi, melegítse elő az üres sütőt	Alsó + felső sütés	170	20 - 30







TÖBB SZINTEN VALÓ SÜTÉS. Teasütemény

		 (°C)	 (perc)	
Linzer / Omlós tészták	Hőlégbefűtés, nagy hőfok	140	25 - 45	1 / 4



TÖBB SZINTEN VALÓ SÜTÉS. Teasütemény

		 (°C)	 (perc)	
Aprósütemény, 20 db/ tepsi, melegítse elő az üres sütőt	Hőlégbefúvás, nagy hő- fok	150	23 - 40	1 / 4
Piskótateszta (zsiradék nélkül)	Hőlégbefúvás, nagy hő- fok	160	35 - 50	1 / 4







GRILL



Melegítse elő az üres sütőt 5 perccig.



Grillezés maximális hőmérséklettel.

		 (perc)	
Toast kenyér	Grill	1 - 3	5
Bifsztek, félidőben fordítsa meg	Grill	24 - 30	4



11. ÁPOLÁS ÉS TISZTÍTÁS



FIGYELMEZTETÉS!

Lásd a „Biztonság” című fejezetet.

11.1 Tisztítással kapcsolatos megjegyzések

 Tisztítósze- rek	A sütő elejét meleg vizes és enyhe mosogatószeres puha ruhával tisztítsa meg.
	A fémfelületeket háztartási tisztítószerekkel tisztítsa meg.
	A szennyeződések elenyhe mosogatószerrel távolítsa el.
 Napi haszná- lat	A sütőteret minden használat után tisztítsa meg. A lerakódott zsír vagy egyéb maradvány tüzet okozhat.
	Ne tárolja az ételeket több, mint 20 percig a sütőben. Minden használat után puha törlőruhával törölje szárazra a sütő belsejét.
 Tartozékok	Minden használat után tisztítsa és szárítsa meg az összes tartozékot. Puha ruhával, langyos vízzel és enyhe mosogatószerrel végezze a tisztítást. A tartozékokat tilos mosogatógépben tisztítani.
	A teflon bevonatos tartozékokat ne tisztítsa súroló hatású tisztítószerekkel vagy éles tárgyakkal.

11.2 Hogyan tisztítsa: Sütőtér mélyedése

Gőzben sütés után tisztítsa ki a sütőtér bemélyedéséből a lerakódott vízkőmaradványokat.

1. lépés	2. lépés	3. lépés
Öntsön 250 ml fehér ecetet a sütőtér mélyedésébe. Legfeljebb 6%-os, adalékmentes ecetet használjon.	30 percig hagyja környezeti hőmérsékleten, hogy az ecet feloldja a vízkőmaradványokat.	Egy puha kendővel és meleg vízzel tisztítsa meg a sütőtérrel.
Az alábbi funkcióval: SteamBake 5 - 10 sütési ciklusonként takarítsa ki a sütőt.		

11.3 Hogyan távolítsa el: Polctartók

A sütő tisztításához vegye ki a polctartókat.

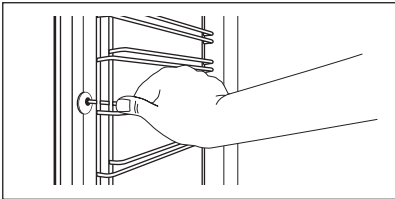
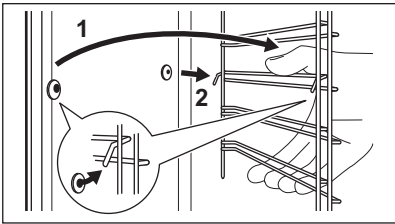
1. lépés	Kapcsolja ki a sütőt, és várja meg, hogy lehűljön.	
2. lépés	Húzza el a polctartó elülső részét az oldalfaltól.	
3. lépés	Húzza el a polctartó hátulját az oldalfaltól, majd vegye ki.	
4. lépés	A polctartókat a kiszereléssel ellentétes sorrendben tegye vissza. A teleszkópos sütősíneken található tartócsapok előre nézzenek.	

11.4 Hogyan használja: Pirolitikus tisztítás

A sütőt a Pirolitikus tisztítás funkcióval tisztítsa.



FIGYELMEZTETÉS!

Égés veszélye áll fenn.



VIGYÁZAT!

Amennyiben a készülék konyhaszekrényébe egyéb berendezés is be van építve, ne használja azt, amikor ez a funkció működik. Ez kárt tehet a sütőben.



A Pirolitikus tisztítás előtt:

Kapcsolja ki a sütőt, és várja meg, hogy lehűljön.	Vegyen ki minden tartozékot a sütőtérből és a kivehető polctartókat is távolítsa el.	Puha ruhával, langyos vízzel és enyhe mosogatószerrel tisztítsa meg a sütőtér alját és a sütőajtó üvegének belső oldalát.
--	--	---

Pirolitikus tisztítás

1. lépés	Lépjön az alábbi menübe: Tisztítás mm / .	
Kiegészítő funkció	Időtartam	
C1 - Enyhe tisztítás	1 h	
C2 - Normál tisztítás	1 h 30 min	

ÁPOLÁS ÉS TISZTÍTÁS

Pirolitikus tisztítás	
C3 - Alapos tisztítás	3 h
2. lépés	OK - nyomja meg a tisztítóprogram kiválasztásához.
3. lépés	OK - nyomja meg a tisztítás elindításához.
4. lépés	Tisztítás után forgassa a sütőfunkciók szabályozógombját kikapcsolt helyzetbe.
 A tisztítás során a sütőlámpa kikapcsol.	
Amikor a sütő eléri a beállított hőmérsékletet, az ajtó reteszelődik. Az ajtózár kioldásáig a kijelzőn az alábbiak láthatók:  .	

Amikor a tisztítás véget ér:		
Kapcsolja ki a sütőt, és várja meg, hogy lehűljön.	Egy puha kendővel tisztítsa meg a sütőteret.	A sütőtér aljáról távolítsa el az ételmaradványokat.

11.5 Tisztítás emlékeztető

A sütő emlékezteti, ha a pirolitikus tisztítás esedékessé válik.	
 villog a kijelzőn 5 másodpercig minden főzési ciklus végén.	Az emlékeztető kikapcsolásához lépjen ide: Menü, majd válassza ezt: Beállítások, Tisztítás emlékeztető.

11.6 eltávolítás és visszaszerelés: Ajtó

A tisztításhoz az ajtó és a belső üveglapok eltávolíthatók. Az üveglapok száma különböző modellek esetén eltérő.



FIGYELMEZTETÉS!

Az ajtó nehéz.



VIGYÁZAT!

Óvatosan kezelje az üveget, különösen az elülső lap pereménél. Az üveg eltörhet.

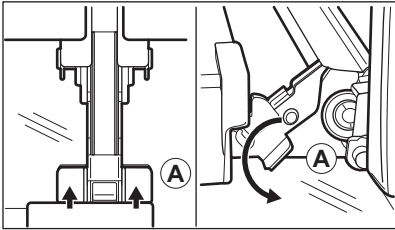
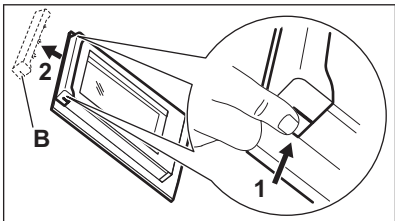
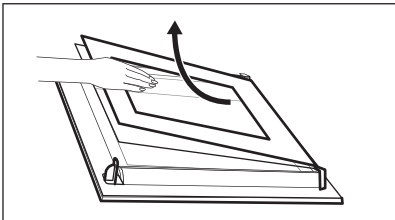
1. lépés	Teljesen nyissa ki az ajtót.	
2. lépés	Emelje meg, majd nyomja a rögzítőkarokat (A) az ajtó két zsanérjára.	
3. lépés	Csukja be a sütőajtót az első nyitási pozícióig (kb. 70°-os szög). Fogja meg az ajtó mindkét oldalát, és felfelé irányuló szögben húzza le a sütőről. Helyezze a sütőajtót külső oldalával lefelé fordítva egy puha és egyenletes felületre.	
4. lépés	Tartsa az ajtó burkolatát (B) az ajtó felső szélénél a két oldalán, és nyomja befelé, hogy leválassza a zárósínt.	
5. lépés	Húzza előre a díszlécet az eltávolításhoz.	
6. lépés	Egyenként fogja meg az ajtó üveglapjait a felső szélüknél, és felfele húzva vegye ki őket az oldalsó vezetősínből.	
7. lépés	Tisztítsa meg az üveglapot mosogatószeres vízzel. Óvatosan törölje szárazra az üveglapot. Az üveglapokat tilos mosogatógépben tisztítani.	
8. lépés	Tisztítás után ismételje meg fordított sorrendben a fenti lépéseket.	
9. lépés	Először a kisebb lapot helyezze vissza, majd a nagyobbat és az ajtót. Ügyeljen arra, hogy az üveglapok a megfelelő helyzetben legyenek behelyezve, más különben az ajtó felülete túlmelegedhet.	

11.7 Hogyan cserélje: Lámpa



FIGYELMEZTETÉS!

Vigyázat! Áramütés-veszély!
Az izzó forró lehet.

HIBAELHÁRÍTÁS

A sütővilágítás izzójának cseréje előtt:

1. lépés	2. lépés	3. lépés
Kapcsolja ki a sütőt. Várja meg, míg a sütő lehűl.	Húzza ki a sütőt a hálózati aljzatból.	Tegyen egy kendőt a sütőtér aljára.

Felső lámpa

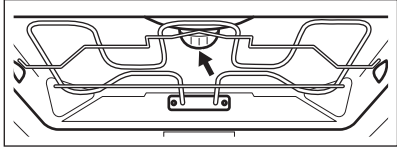
1. lépés	Az üvegbura eltávolításához fordítsa azt az óramutató járásával ellentétes irányba.	
2. lépés	Tisztítsa meg az üvegburát.	
3. lépés	Cserélje ki az izzót egy megfelelő, 300 °C-ig hőálló izzóra.	
4. lépés	Szerelje fel az üvegburát.	

12. HIBAELHÁRÍTÁS



FIGYELMEZTETÉS!

Lásd a „Biztonság” című fejezetet.

12.1 Mi a teendő, ha...

A táblázatban nem szereplő bármilyen más esetben forduljon a márkaszervizhez.



A sütő nem kapcsol be vagy nem melegszik fel

Probléma	Ellenőrizze, ha...
Nem lehet elindítani vagy üzemeltetni a sütőt.	A sütőt megfelelően csatlakoztatta az elektromos hálózathoz.
A sütő nem melegszik fel.	Az automatikus kikapcsolás ki van kapcsolva.
A sütő nem melegszik fel.	A sütőajtó be van csukva.
A sütő nem melegszik fel.	Nem olvadt le a biztosíték.



A sütő nem kapcsol be vagy nem melegszik fel

A sütő nem melegszik fel.

A Gyerekzár ki van kapcsolva.



Alkotóelemek

Probléma

Ellenőrizze, ha...

A sütővilágítás ki van kapcsolva.

Konvekciós levegő (nedves) bekapcsolva.

A lámpa nem működik.

Kiégett az izzó.



Hibakódok

A kijelzőn a következő látható:

Ellenőrizze, ha...

Err C3

A sütőajtó be van zárva, vagy az ajtózár nincs feloldva.

Err F102

A sütőajtó be van csukva.

Err F102

Az ajtózár nincs feloldva.

00:00 érték látható

Áramkimaradás történt. Állítsa be a pontos időt.

Ha a kijelzőn olyan hibakód látható, amely nem szerepel ebben a táblázatban, kapcsolja le és vissza a lakásban lévő kismegszakítót a sütő újraindításához. Ha a hibakód ismét megjelenik, forduljon a márkaszervizhez.



Tisztítás

Probléma

Ellenőrizze, ha...

A víz kifolyik a sütőtér bemélyedéséből.

Túl sok víz van a sütőtér mélyedésében.

ENERGIAHATÉKONYSÁG

12.2 A szerviz számára szükséges adatok

Ha nem talál megoldást egyedül a problémára, forduljon a márkakereskedőhöz vagy a hivatalos márkaszervizhez.

A márkaszerviz számára szükséges adatok az adattáblán találhatóak. Az adattábla a sütőtér előlő keretén található. Ne távolítsa el az adattáblát a készülék sütőterének keretéről.

Javasoljuk, hogy az adatokat jegyezze fel ide:	
Típus (MOD.)
Termékszám (PNC)
Sorozatszám (S.N.)

13. ENERGIAHATÉKONYSÁG

13.1 Termékre vonatkozó információk és Termékismertető*

Gyártó neve	AEG	
A készülék azonosítójele	BPB351160M 944188506 BPS351160M 944188507	
Energhatékonyági szám	81.2	
Energhatékonyági osztály	A+	
Villamosenergia-fogyasztás normál adag és alsó + felső sütés mellett	1.09 kWh/ciklus	
Villamosenergia-fogyasztás normál terhelés és légkeveréses sütés mellett	0.69 kWh/ciklus	
Sütőterek száma	1	
Hőforrás	Villamos energia	
Hangerő	71 l	
Sütő típusa	Beépíthető sütő	
Tömeg	BPB351160M	34.0 kg
	BPS351160M	34.0 kg

* Az Európai unió számára az EU 65/2014 és 66/2014 sz. rendeletek szerint.
Fehéroroszország számára az STB 2478-2017, G függelék; STB 2477-2017, A és B függelék szerint.
Ukrajna számára az 568/32020 sz. rendelet szerint.

Az energiahatékonysági osztály nem alkalmazható Oroszország esetében.

EN 60350-1 - Háztartási elektromos főzőkészülékek - 1. rész: Tartományok, sütők, gőzsütők és grillezők - A teljesítmény mérésére szolgáló módszerek.

13.2 Energiatakarékosság



A sütő több funkcióval is segít energiát megtakarítani a mindennapos főzés során.

Ügyeljen rá, hogy használat közben a sütő ajtaja be legyen csukva. Sütés közben ne nyissa ki túl gyakran a sütő ajtaját. Tartsa tisztán az ajtótomítést, és ügyeljen rá, hogy megfelelően legyen a helyére rögzítve.

Fém főzőedényeket használjon az energiatakarékosság javítása érdekében.

Amikor lehetséges, kerülje a sütő előmelegítését.

Ha egyszerre több ételt készít, a sütések közötti szünet legyen a lehető legrövidebb.

Légkeveréses sütés

Amikor csak lehetséges, a sütőfunkciókat légkeveréssel használja az energiatakarékosság érdekében.

Maradékhő

A sütővilágítás és a légkeverés továbbra is működik. Amikor kikapcsolja a sütőt, a kijelző jelzi a maradékhőt. A maradékhőt használhatja az étel melegen tartásához.

A 30 percnél hosszabb ideig tartó sütés során a befejezés előtt 3 - 10 perccel csökkentse a sütő hőmérsékletét a minimum értékre. A sütőben levő maradékhő tovább folytatja a sütést.

A maradékhőt más ételek felmelegítéséhez is használhatja.

Ételek melegen tartása

A maradékhőt használhatja az étel melegen tartásához. Ehhez válassza a lehető legalacsonyabb hőmérséklet-beállítást. A maradékhő visszajelző vagy a hőmérséklet megjelenik a kijelzőn.

Sütés kikapcsolt sütővilágítással

Sütés közben kapcsolja ki a sütővilágítást. Csak akkor kapcsolja be, amikor szükség van rá.

Konvekciós levegő (nedves)

A funkciót arra tervezték, hogy energiát takarítson meg a sütés során.

E funkció használatakor a sütővilágítás 30 másodperc elteltével automatikusan kikapcsol. A sütővilágítást ismét bekapcsolhatja, azonban ez a lépés csökkenti a várható energiamegtakarítás mértékét.



14. A MENÜ FELÉPÍTÉSE

14.1 Menü



- válassza ezt a Menü-re lépéshez.



A MENÜ FELÉPÍTÉSE

A Menü felépítése		
Előre programozott sütés 	Tisztítás 	Beállítások 

1. lépés	2. lépés	3. lépés	4. lépés	5. lépés
				
Válassza a Menü, Beállítások lehetőségeket.	Erősítse meg a beállítást.	Válassza ki a beállítást.	Erősítse meg a beállítást.	Állítsa be az értéket, majd nyomja meg a OK gombot.

Beállítások					
O1	Pontos idő	Módosítás	O2	Kijelző fényerő	1 - 5
O3	Nyomógomb Hang	1 - Hangjelzés 2 - Kattanás 3 - Hang ki-kapcsolva	O4	Figyelmeztető hang-erő	1 - 4
O5	Működésidőzítő	Be/Ki	O6	Sütő világítás	Be/Ki
O7	Gyors felfűtés	Be/Ki	O8	Tisztítás emlékeztető	Be/Ki
O9	Demo üzemmód	Aktiváló kód: 2468	O10	Szoftver verzió	Ellenőrzés
O11	Összes beállítás törlése	Igen / Nem			

15. KÖRNYEZETVÉDELMI TUDNIVALÓK

A  következő jelzéssel ellátott anyagokat hasznosítsa újra. Újrahasznosításhoz tegye a megfelelő konténerekbe a csomagolást. Járuljon hozzá környezetünk és egészségünk védelméhez, és hasznosítsa újra az elektromos és elektronikus hulladékot. A  tiltó

szimbólummal ellátott készüléket ne dobja a háztartási hulladék közé. Juttassa el a készüléket a helyi újrahasznosító telepre, vagy lépjen kapcsolatba a hulladékkezelésért felelős hivatallal.

NEVAINOJAMIEM REZULTĀTIEM

Pateicamies, ka izvēlējāties AEG izstrādājumu! Esam to radījuši, lai nodrošinātu nevainojamu izpildi daudzu gadu garumā, izmantojot inovatīvas tehnoloģijas, kas palīdz vienkāršot dzīvi — iespējas, ko neatradīsiet parastās ierīcēs. Lūdzu, veltiet dažas minūtes tam, lai izlasītu šo materiālu un gūtu labākus rezultātus.

Apmeklējiet mūsu tīmekļa vietni, lai:



saņemtu lietošanas ieteikumus un brošūras, kā arī traucējummeklēšanas, servisa un remonta informāciju:

www.aeg.com/support



reģistrētu savu ierīci labāka servisa saņemšanai:

www.registeraeg.com



iegādātos savai ierīcei papildpiederumus, vienreizējas lietošanas materiālus un oriģinālās rezerves daļas:

www.aeg.com/shop



Lai saņemtu vairāk receptes, ieteikumus un traucējummeklēšanas padomus, lejupielādējiet lietotni **My AEG Kitchen**.



KLIENTU APKALPOŠANA UN SERVISS

Izmantojiet tikai oriģinālās rezerves daļas.

Sazinoties ar mūsu pilnvaroto servisa centru, nodrošiniet, lai jums būtu pieejami šādi dati: modelis, PNC, sērijas numurs.

Šī informācija ir norādīta uz datu plāksnītes.

 Uzmanību / drošības informācija

 Vispārīga informācija un ieteikumi

 Ar vidi saistīta informācija

Izmaiņu tiesības rezervētas.

SATURS

1. DROŠĪBAS INFORMĀCIJA.....	257	2.7 Servisa izvēlne.....	262
1.1 Bērnu un neaizsargātu personu drošība.....	257	2.8 Likvidēšana.....	262
1.2 Vispārīgā drošība.....	258	3. IZSTRĀDĀJUMA APRAKSTS.....	262
2. DROŠĪBAS NORĀDĪJUMI.....	259	3.1 Vispārējs pārskats.....	263
2.1 Uzstādīšana.....	259	3.2 Papildpiederumi.....	263
2.2 Pieslēgums elektrotīklam.....	260	4. CEPEŠKRĀSNS IESLĒGŠANA UN IZSLĒGŠANA.....	264
2.3 Lietošana.....	260	4.1 Iegremdējamie regulatori.....	264
2.4 Aprūpe un tīrīšana.....	261	4.2 Vadības panelis.....	264
2.5 Pirolītiskā tīrīšana.....	261		
2.6 Iekšējais apgaismojums.....	262		

5. PIRMS PIRMĀS LIETOŠANAS REIZES. 265	10.3 Gatavošanas tabulas pārbaudes iestādēm..... 279
5.1 Sākotnējā tīrīšana..... 265	11. KOPŠANA UN TĪRĪŠANA..... 281
5.2 Sākotnējā uzkarsēšana..... 266	11.1 Piezīmes par tīrīšanu..... 282
6. IZMANTOŠANA IKDIENĀ..... 266	11.2 Kā tīrīt? Tīltnes reljefs..... 282
6.1 Karsēšanas funkcijas iestatīšana.266	11.3 Kā izņemt: Plauktu balsti 282
6.2 Karsēšanas funkcijas.....267	11.4 Funkcijas Pirolītiskā tīrīšana izmantošana..... 283
6.3 Ieslēgtas piezīmes: Ventilatora kars. ar mitrumu.....268	11.5 Tīrīšanas atgādinājums.....284
6.4 Gatavošanas palīgs iestatīšana... 269	11.6
6.5 Gatavošanas palīgs ar receptēm.269	Izņemšana un uzstādīšana: Durvis.... 284
7. PULKSTEŅA FUNKCIJAS..... 275	11.7 Kā nomainīt: Lampa..... 285
7.1 Pulksteņa funkcijas..... 275	12. PROBLĒMRISINĀŠANA..... 286
7.2 Pulksteņa funkcijas iestatīšana...275	12.1 Kā rīkoties, ja..... 286
8. IZMANTOŠANA: PAPILDPIEDERUMI.... 277	12.2 Apkopes dati..... 288
8.1 Piederumu ievietošana..... 277	13. ENERGOEFEKTIVITĀTE..... 288
9. PAPILDFUNKCIJAS..... 277	13.1 Produkta informācija un produkta informācijas lapa*..... 288
9.1 Bloķēšana..... 278	13.2 Elektroenerģijas taupīšana..... 289
9.2 Automātiskā izslēgšanās..... 278	14. IZVĒLNES STRUKTŪRA..... 289
9.3 Dzesēšanas ventilators.....278	14.1 Izvēlne..... 289
10. PADOMI UN IETEIKUMI..... 278	
10.1 Ventilatora kars. ar mitrumu.....278	
10.2 Ventilatora kars. ar mitrumu - ieteicamie piederumi.....279	

1. ⚠ DROŠĪBAS INFORMĀCIJA

Pirms ierīces uzstādīšanas un lietošanas rūpīgi izlasiet pievienotos norādījumus. Ražotājs neatbild par savainojumiem un bojājumiem, kas radušies ierīces nepareizas uzstādīšanas vai izmantošanas rezultātā. Glabājiet šīs instrukcijas drošā, pieejamā vietā, lai tās varētu izmantot nākotnē.

1.1 Bērnu un neaizsargātu personu drošība

- Šo ierīci drīkst izmantot bērni no 8 gadu vecuma un cilvēki ar ierobežotām fiziskām, sensorām vai garīgām spējām vai pieredzes un zināšanu trūkumu atbildīgas personas uzraudzībā vai, ja tie ir informēti par ierīces drošu lietošanu un izprot potenciālos riskus. Bērniem no līdz 8 gadu

- vecumam un personām ar ļoti plašu un sarežģītu invaliditāti jāliedz piekļuve ierīcei, ja vien tos nepārtraukti neuzrauga.
- Mazi bērni jāuzrauga, lai viņi nerotaļātos ar ierīci.
 - Neļaujiet bērniem tuvoties iepakojumam un atbrīvojieties no tā pienācīgā veidā.
 - **UZMANĪBU!** Neļaujiet bērniem un mājdzīvniekiem atrasties ierīces tuvumā, kad tā darbojas vai atdziest. Ierīces pieejamās daļas lietošanas laikā sakarst.
 - Ja ierīcei ir bērnu drošības ierīce, tā jāaktivizē.
 - Bērni nedrīkst tīrīt ierīci un veikt tās apkopi bez uzraudzības.

1.2 Vispārīgā drošība

- Ierīces uzstādīšanu un vada nomaiņu drīkst veikt tikai kvalificēts speciālists.
- Nelietojiet ierīci pirms tās iebūvēšanas.
- Pirms visu veidu apkopes veikšanas atvienojiet ierīci no elektrotīkla.
- Ja elektrības padeves vads ir bojāts, lai izvairītos no elektrības trieciena riska, to jānomaina ražotājam, autorizētajam servisa centram vai citam kvalificētam speciālistam.
- **BRĪDINĀJUMS!** Pirms lampas mainīšanas pārlicinieties, vai ierīce ir izslēgta, lai neizraisītu elektrošoku.
- **BRĪDINĀJUMS!** Lietošanas laikā ierīce sakarst. Nepieskarieties sildelementiem.
- Vienmēr izmantojiet cepeškrāsns cimdus, izņemot vai ievietojot papildpiederumus vai cepeškrāsns traukus.
- Lai izņemtu plauktu balstus, vispirms pavelciet plauktu balsta priekšu un tad aizmuguri nost no sānu sienām. Uzstādiet plauktu balstus, veicot iepriekšminētās darbības pretējā secībā.
- Netīri ierīci ar tvaika tīrītāju.

- Stikla durvju tīrīšanai neizmantojiet raupjus, abrazīvus tīrīšanas līdzekļus vai asus metāla skrāpjus, jo tie var saskrāpēt virsmas, un tādējādi stikls var saplīst.
- Pirms pirolītiskās tīrīšanas ir jānotīra liekie izlijušie produkti. Izņemiet no cepeškrāsns visas daļas.

2. DROŠĪBAS NORĀDĪJUMI

2.1 Uzstādīšana



BRĪDINĀJUMS!

Ierīci drīkst uzstādīt tikai kvalificēta persona.

- Noņemiet visu iesaiņojumu.
- Neuzstādiet un nelietojiet bojātu ierīci.
- Ievērojiet kopā ar ierīci piegādātās uzstādīšanas norādes.
- Vienmēr uzmanīgi pārvietojiet ierīci, jo tā ir smaga. Vienmēr izmantojiet drošības cimdus un slēgtus apavus.
- Nevelciet ierīci aiz roktura.
- Uzstādiet ierīci drošā un atbilstošā vietā, kas atbilst uzstādīšanas prasībām.
- Nodrošiniet starp blakus uzstādītām ierīcēm piemērotu attālumu.
- Pirms ierīces uzstādīšanas pārlicinieties, ka būs iespējams brīvi atvērt cepeškrāsns durvis.
- Ierīce ir aprīkota ar elektrisku dzesēšanas sistēmu. Tā ir jādarbina ar elektrības padevi.
- Iebūvētajai ierīcei jāatbilst standarta DIN 68930 stabilitātes prasībām.

Skapīša minimālais augstums (skapīša zem darba virsmas minimālais augstums)	578 (600) mm
Skapīša platums	560 mm
Skapīša dziļums	550 (550) mm
Ierīces priekšpuses augstums	594 mm
Ierīces aizmugures augstums	576 mm
Ierīces priekšpuses platums	595 mm
Ierīces aizmugures platums	559 mm
Ierīces dziļums	567 mm
Ierīces iebūvēšanas dziļums	546 mm
Ierīces dziļums ar atvērtām durvīm	1027 mm

DROŠĪBAS NORĀDĪJUMI

Ventilācijas atveres minimālais izmērs. Atvere apakšējā aizmugurējā daļā	560 x 20 mm
Strāvas kabeļa garums. Kabelis tiek novietots aizmugurējā labajā stūrī	1500 mm
Montāžas skrūves	4 x 25 mm

2.2 Pieslēgums elektrotīklam



BRĪDINĀJUMS!

Var izraisīt ugunsgrēku un elektrošoku.

- Elektrības padeves pieslēgšana jāveic sertificētam elektriķim.
- Ierīcei jābūt iezemētai.
- Pārliecinieties, ka tehnisko datu plāksnītē norādītie parametri atbilst elektrotīkla parametriem.
- Vienmēr izmantojiet pareizi uzstādītu un drošu kontaktligzdu.
- Nelietojiet daudzkontakta adapterus vai pagarinātājus.
- Rīkojieties uzmanīgi, lai nesabojātu kontaktspraudni un kabeli. Ja iekārtas elektropadeves kabeli nepieciešams nomainīt, to jāveic tuvākajā autorizētajā servisa centrā.
- Neļaujiet strāvas kabeļiem saskarties ar ierīces durvīm vai nišu zem ierīces vai atrasties to tuvumā, it īpaši, ja tā darbojas vai durvis ir karstas.
- Daļas, kas nodrošina aizsardzību pret elektrošoku no strāvu vadošiem un izolētajiem elementiem, jānostiprina tā, lai tos nevarētu noņemt bez instrumentiem.
- Pieslēdziet kontaktspraudni kontaktligzdai tikai uzstādīšanas beigās. Pārbaudiet, vai pēc uzstādīšanas kontaktspraudnim var brīvi piekļūt.
- Ja kontaktligzda ir vaļīga, neievietojiet tajā kontaktspraudni.
- Nekad neatslēdziet ierīci no tīkla, velkot aiz strāvas kabeļa. Vienmēr velciet aiz kontaktspraudņa.
- Ir jāizmanto atbilstošas izolācijas ierīces: automātslēdži, drošinātāji (no turētājiem izskrūvējami drošinātāji), zemējuma noplūdes automātslēdži un savienotāji.
- Elektroinstalācijā jābūt izolācijas ierīcei, kas ļauj atvienot ierīci no visiem elektrotīkla poliem. Izolācijas ierīcē atstarpei starp kontaktiem jābūt vismaz 3 mm.
- Pilnībā aizveriet ierīces durvis pirms kontaktspraudņa ievietošanas elektrotīkla kontaktligzdā.
- Šī ierīce ir aprīkota ar barošanas vadu un kontaktdakšu.

2.3 Lietošana



BRĪDINĀJUMS!

Pastāv traumu, apdegumu, elektrošoka vai sprādziena risks.

- Šī ierīce ir paredzēta tikai izmantošanai mājas apstākļos (iekštelpās).
- Nemainiet šī produkta specifikāciju.
- Pārliecinieties, ka ierīces ventilācijas atveres nav nosprostotas.
- Lietošanas laikā neatstājiet ierīci bez uzraudzības.
- Izslēdziet ierīci pēc katras lietošanas reizes.
- Ievērojiet piesardzību, atverot ierīces durvis, kamēr tā darbojas. Var notikt karsta gaisa izplūšana.

- Nelietojiet ierīci ar mitrām rokām, vai ja ierīce nonākusi saskarē ar ūdeni.
- Nepielietojiet spiedienu uz cepeškrāsns durvīm.
- Nelietojiet ierīci kā darba virsmu vai uzglabāšanai paredzētu virsmu.
- Atveriet ierīces durvis piesardzīgi. Izmantojot sastāvdaļas, kas satur spirtu, var rasties spirta tvaiku un gaisa maisījums.
- Neļaujiet dzirkstelēm vai atvērtai liesmai nonākt saskarē ar ierīci, kad atverat durvis.
- Neievietojiet ierīcē un neglabājiet tās tuvumā vai uz tās viegli uzliesmojošas vielas vai ar viegli uzliesmojošām vielām piesūcinātus priekšmetus.



BRĪDINĀJUMS!

Pastāv ierīces bojājumu risks.

- Lai novērstu emaljas bojājumus vai krāsas maiņu:
 - neievietojiet cepeškrāsns traukus vai citus priekšmetus nepastarpināti uz ierīces grīdas;
 - nenovietojiet alumīnija foliju nepastarpināti uz ierīces grīdas;
 - neļējiet ūdeni karstā ierīcē.
 - neatstājiet ierīcē mitrus traukus un produktus pēc gatavošanas beigām.
 - ievērojiet piesardzību, izņemot vai ievietojot papildaprīkojumu.
- Emaljas vai nerūsējošā tērauda krāsas maiņa neietekmē ierīces darbību.
- Mitrām kūkām izmantojot dziļo pannu. Augļu sulas var radīt paliekošus traipus.
- Šī ierīce paredzēta tikai ēdiena gatavošanai. Ierīci aizliegts izmantot citiem nolūkiem, piemēram, telpu apsildei.
- Vienmēr gatavojiet pārtiku ar aizvērtām cepeškrāsns durvīm.
- Ja ierīce ir uzstādīta aiz mēbeļu paneļa (piemēram, aiz durvīm), pārliecinieties, ka ierīces darbības laikā šīs durvis nekad nav aizvērtas. Aiz aizvērtā mēbeļu paneļa var uzkrāties siltums un mitrums un attiecīgi izraisīt ierīces, iebūvētās mēbeles vai grīdas bojājumus. Neaizveriet mēbeļu paneli līdz ierīce pēc lietošanas nav pilnīgi atdzisusi.

2.4 Aprūpe un tīrīšana



BRĪDINĀJUMS!

Pastāv savainojumu un ierīces aizdegšanās un bojājumu risks.

- Pirms apkopes izslēdziet ierīci un atvienojiet to no elektrotīkla.
- Pārliecinieties, vai ierīce ir auksta. Pastāv risks, ka stikla paneli var iepļīst.
- Ja durvju stikla paneli tiek bojāti, nomainiet tos nekavējoties. Sazinieties ar pilnvaroto servisa centru.
- Noņemot durvis no ierīces, rīkojieties uzmanīgi. Durvis ir smagas!
- Regulāri tīriet ierīci, lai novērstu virsmas materiāla nolietošanos.
- Tīriet ierīci ar mitru, mīkstu drānu. Izmantojiet tikai neitrālus mazgāšanas līdzekļus. Neizmantojiet abrazīvus izstrādājumus, abrazīvus sūkļus, šķīdinātājus vai metāla priekšmetus.
- Ja lietojat cepeškrāsns tīrīšanai paredzētus aerosolus, ievērojiet ražotāja drošības norādījumus, kas atrodami uz iepakojuma.

2.5 Pirolītiskā tīrīšana



BRĪDINĀJUMS!

Savainojumu/aizdegšanās/ķīmisko izmešu (dūmu) risks pirolītiskajā režīmā.

- Pirms pirolītiskās pašattīrīšanas funkcijas vai pirmās lietošanas reizes no cepeškrāsns iekšpuses jāizņem:

IZSTRĀDĀJUMA APRAKSTS

- pārtikas atliekas, eļļas vai taukvielu noplūdes / nogulas.
- visi izņemamie priekšmeti (tostarp, plaukti, sānu vadotnes u. tml. daļas, kas ietilpst ierīces komplektācijā), jo īpaši nepiedegošie katli, pannas, paplātes, piederumi, utt.
- Rūpīgi izlasiet visas norādes par pirolītisko tīrīšanu.
- Neļaujiet bērniem tuvojies ierīcei, kamēr darbojas pirolītiskā tīrīšana. Ierīce kļūst ļoti karsta, un no priekšējām dzesēšanas atverēm nāk karsts gaiss.
- Tā kā pirolītiskā tīrīšana notiek pie augstas temperatūras un var izraisīt dūmu veidošanos no ēdiena atliekām un konstrukciju materiāliem, to izmantojot tiek stingri ieteikts:
 - pirms un pēc pirolītiskās tīrīšanas nodrošināt labu ventilāciju.
 - nodrošināt labu ventilāciju ierīces pirmās lietošanas laikā un pēc tās, darbojoties ar maksimālo temperatūru.
- Atšķirībā no cilvēkiem, daži putni un rūpuļi var būt ļoti jutīgi pret potenciālajiem izgarojumiem, kuri veidojas ar pirolītisko funkciju aprīkoto cepeškrāšņu tīrīšanas procesa laikā.
 - Nodrošināt, lai neviens mājdzīvnieks (īpaši putni) neatrastos ierīces tuvumā pirolīzes tīrīšanas laikā un pēc tās, un vispirms ieslēgt maksimālo temperatūru labi ventilētā telpā.
- Mazie mājdzīvnieki arī var būt ļoti jutīgi pret lokālām temperatūras izmaiņām ar pirolītisko funkciju aprīkoto cepeškrāšņu tuvumā, kad ieslēgta pirolītiskā pašattīrīšanas programma.
- Ar pirolītisko funkciju aprīkoto cepeškrāšņu pirolītiskās tīrīšanas laikā, tai sasniedzot augstu temperatūru, katlu, pannu, paplāšu, piederumu utt., nepiedegošās virsmas var tikt bojātas un var izdalīt nedaudz kaitīgus izgarojumus.
- Ar pirolītisko funkciju aprīkoto cepeškrāšņu / gatavoto ēdienu palieku izdalītie izgarojumi, saskaņā ar aprakstu, nav kaitīgi cilvēkiem, tai skaitā bērniem un personām ar slimībām.

2.6 Iekšējais apgaismojums



BRĪDINĀJUMS!

Pastāv risks saņemt elektrošoku.

- Informācija par šajā produktā esošo lampu (lampām) un atsevišķi nopērkamajām rezerves lampām: Šīs lampas ir paredzētas ekstremāliem fiziskajiem apstākļiem, piemēram, temperatūrai, vibrācijai, mitrumam, māsaimniecības ierīcēs vai paredzētas informēšanai par ierīces darbības statusu. Tās nav paredzētas citiem lietošanas veidiem un nav piemērotas māsaimniecības telpu apgaismojumam.
- Izmantojiet tikai tādu pašu specifikāciju spuldzes.

2.7 Servisa izvēlne

- Lai salabotu ierīci, sazinieties ar pilnvarotu servisa centru.
- Lietojiet tikai oriģinālas rezerves daļas.

2.8 Likvidēšana



BRĪDINĀJUMS!

Pastāv savainošanās vai nosmakšanas risks.

- Atvienojiet ierīci no elektropadeves.
- Nogrieziet strāvas kabeli netālu no ierīces un utilizējiet to.
- Noņemiet durvju fiksatoru, lai bērni vai mājdzīvnieki nevarētu ierāpties ierīcē un tur sevi ieslēgt.

3. IZSTRĀDĀJUMA APRAKSTS

3.1 Vispārējs pārskats

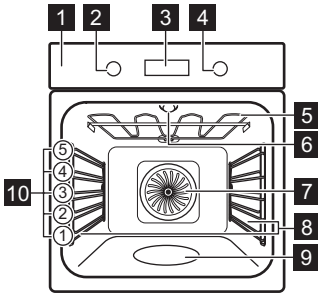

- 1** Vadības panelis
- 2** Karsēšanas funkciju pārslēgš
- 3** Displejs
- 4** Vadības regulators
- 5** Sildelements
- 6** Lampa
- 7** Ventilators
- 8** Plaukta atbalsts, izņemams
- 9** Plauktu līmeņi
- 10** Cepeškrāsns tilpnes reljefs

3.2 Papildpiederumi

Restots plaukts

Gatavošanas traukiem, kūku formām, cepešiem.

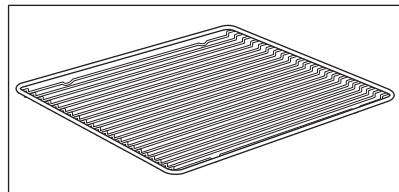

Cepamā Paplāte

Kūkām un biskvītiem.

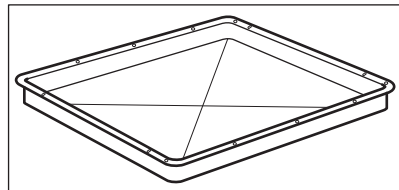

CEPEŠKRĀSNIS IESLĒGŠANA UN IZSLĒGŠANA

Grila/ceпамā panna

Lai apbrūninātu un ceptu, vai kā paliktis tauku savākšanai.

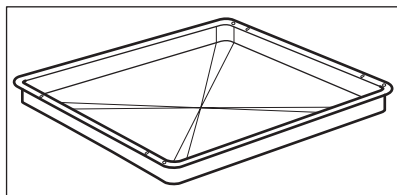

Teleskopiskās vadotnes

Lai vieglāk ieliktu un izņemtu paplātes un restoto plauktu.

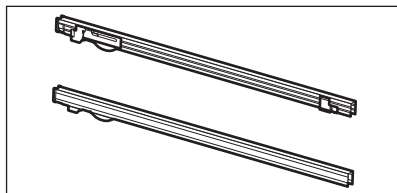







4. CEPEŠKRĀSNIS IESLĒGŠANA UN IZSLĒGŠANA

4.1 Iegremdējamie regulatori

Lai lietotu ierīci, piespiediet regulatoru. Regulators izvirsās uz āru.

4.2 Vadības panelis

Vadības paneļa sensora taustiņi					Piespiediet	Pagrieziet regulatoru
 Taimers	 Ātrā uzsilšana	 Ap-gai-smo-jums (lam-pa)	 Lock	OK		
Atlasiet karsēšanas funkciju, lai ieslēgtu cepeškrāsni.						
Pagrieziet karsēšanas funkciju regulatoru pozīcijā izslēgts, lai izslēgtu cepeškrāsni.						

	Kad karsēšanas funkcijas pārslēgtas pozīcijā izslēgts, displejs darbojas gaidstāves režīmā.
---	---

PIRMS PIRMĀS LIETOŠANAS REIZES

	<p>Gatavošanas laikā displejs attēlo iestatīto temperatūru, diennakts laiku un citas pieejamās iespējas.</p>
	<p>Displejs ar maksimālo iestatīto funkciju skaitu.</p>

Displeja indikatori

<p>Bloķēšana</p>	<p>Gatavošanas pa- līgs</p>	<p>Tīrīšana</p>	<p>Iestatījumi</p>	<p>Ātrā uzsildšana</p>
<p>Taimera indikatori:</p>				

<p>Progresu josla — temperatūrai vai laikam.</p>	
--	--

<p>Gatavošanas ar tvaiku indikators</p>	
---	--

5. PIRMS PIRMĀS LIETOŠANAS REIZES

	<p>BRĪDINĀJUMS! Skatiet sadaļu "Drošība".</p>
--	--

5.1 Sākotnējā tīrīšana



<p>Pirms pirmreizējās lietošanas iztīriet cepeškrāsni un iestatiet laiku:</p>			
			<p>00:00 Iestatiet laiku. Nospiediet OK.</p>

IZMANTOŠANA IKDIENĀ

5.2 Sākotnējā uzkarsēšana



Iepriekš uzkarsējiet tukšu cepeškrāsni pirms pirmās lietošanas.

1. solis	Izņemiet visus papildpiederumus un noņemamās plauktu balstus no cepeškrāsns.
2. solis	Iestatiet maksimālo temperatūru funkcijai:  Ļaujiet cepeškrāsnij darboties 1 stundu.
3. solis	Iestatiet maksimālo temperatūru funkcijai:  Ļaujiet cepeškrāsnij darboties 15 minūtes.

 Iepriekšējās uzkarsēšanas laikā no cepeškrāsns var izdalīties aromāts un dūmi. Nodrošiniet telpā ventilāciju.



6. IZMANTOŠANA IKDIENĀ





BRĪDINĀJUMS!

Skatiet sadaļu "Drošība".

6.1 Karsēšanas funkcijas iestatīšana

Sāciet gatavot ēdienu	
1. solis	2. solis.
 	 °C
Iestatiet karsēšanas funkciju.	Iestatiet temperatūru.

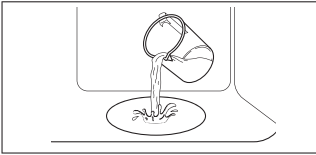

Gatavošana ar tvaiku			
Pārliecinieties, ka cepeškrāsns ir atdzisusi.			
1. solis.	2. solis	3. solis	4. solis









Gatavošana ar tvaiku			
			Iepriekšēji uzkaršējiet tukšu cepeškrāsni 10 minūtes, lai tajā rastos mitrums. Ievietojiet ēdianu cepeškrāsnī.
Uzpildiet cepeškrāsns tīlnes reljefu ar krāna ūdeni.	Iestatiet tvaika karsēšanas funkciju.	Iestatiet temperatūru.	
<p>i Tīlnes cepeškrāsns tīlnes reljefa maksimālā ietilpība ir 250 ml. Neuzpildiet cepeškrāsns tīlnes reljefu gatavošanas laikā vai kamēr cepeškrāsns ir karsta.</p>			

Kad beidzas gatavošanas ar tvaiku cikls,		
1. solis.	2. solis	3. solis.
pagrieziet karsēšanas funkciju regulatoru pozīcijā izslēgts, lai izslēgtu cepeškrāsni.	Uzmanīgi atveriet durvis. No cepeškrāsns izplūstošais mitrums var izraisīt apdegumus.	Pārliecinieties, ka cepeškrāsns ir atdzisusi. Izlejiet atlikušo ūdeni no cepeškrāsns tīlnes reljefa.

6.2 Karsēšanas funkcijas

Standarta karsēšanas funkcijas

Karsēšanas funkcija	Lietošana
 <p>Karsēšana ar ventilatoru</p>	Ēdiena vienlaicīgai cepšanai un kaltēšanai līdz pat trīs plauktu līmenī. Iestatiet temperatūru par 20–40 °C zemāk nekā funkcijai Augš./Apakškarsēšana.
 <p>Augš./Apakškarsēšana</p>	Ēdiena gatavošana un cepšana viena plaukta līmenī.

Karsēšanas funkcija	Lietošana
 <p>SteamBake</p>	Mitruma pievienošanai gatavošanas laikā. Pareizas krāsas un kraukšķīgas virskārtas iegūšanai cepšanas laikā. Sulīguma piešķiršanai ēdienam atkārtotas uzsildīšanas laikā. Augļu vai dārzeņu konservēšanai.
 <p>Picas funkcija</p>	Picas cepšanai. Kārtīgai apbrūnināšanai, lai padarītu kraukšķīgu apakšu.
 <p>Apakškarsēšana</p>	Kūku ar kraukšķīgu pamatni cepšanai un pārtikas konservēšanai.
 <p>Saldēta pārtika</p>	Pusfabrikātu kraukšķīguma (piem., kartupeļi frī, kartupeļu daiviņas vai pilnā pankūciņas) panākšanai.
 <p>Ventilatora kars. ar mitrumu</p>	Šī funkcija ir paredzēta enerģijas taupīšanai gatavošanas laikā. Izmantojot šo funkciju, temperatūra cepeškrāsnis iekšpusē var atšķirties no iestatītās temperatūras. Tiek izmantots atlikušais siltums. Sildīšanas jaudu var samazināt. Plašāka informācija pieejama nodaļā "Ikdienas lietošana" sniegtajās piezīmēs par: Ventilatora kars. ar mitrumu.
 <p>Grils</p>	Plānu produktu grilēšanai un maizes grauzdēšanai.
 <p>Infratermiskā grilēšana</p>	Lielākus cepeša gabalu un mājputnu gaļas ar kauliem cepšanai vienā plaukta līmenī. Sacepumu pagatavošana un apbrūnināšana.
 <p>Izvēlne</p>	Izvēlnes atvēršana: Gatavošanas palīgs, Tīrīšana, Iestatījumi.

6.3 Ieslēgtas piezīmes: Ventilatora kars. ar mitrumu

Šī funkcija tika izmantota, lai atbilstu energoefektivitātes klases un ekodizaina prasībām saskaņā ar standartu ES 65/2014 un ES 66/2014. Pārbaudes saskaņā ar standartu EN 60350-1.





Cepeškrāsnis durvīm jābūt aizvērtām cepšanas laikā, lai funkcija netiktu pārtraukta un cepeškrāsnis darbotos ar vislielāko iespējamo energoefektivitāti.

Izmantojot šo funkciju, lampa automātiski izslēdzas pēc 30 sekundēm.



Gatavošanas norādījumus skatiet sadaļā "Ieteikumi un padomi", Ventilatora kars. ar mitrumu. Vispārīgus elektroenerģijas taupīšanas ieteikumus skatiet nodaļas "Energiefektivitāte" sadaļā "Elektroenerģijas taupīšana".

6.4 Gatavošanas palīgs iestatīšana

Katram ēdienam šajā apakšizvēlnē ir ieteikta funkcija un temperatūra. Gatavošanas laikā jūs varat regulēt laiku un temperatūru.

Gatavošanas palīgs — izmantojiet to, lai ātri pagatavotu ēdienu, izmantojot noklusējuma iestatījumus:			
1. solis.	2. solis	3. solis	4. solis
 ≡	 ✂	 1 - 45	 OK
Atveriet izvēlni.	Atlasiet Gatavošanas palīgs. Nospiediet OK.	Atlasiet ēdiena veidu. Nospiediet OK.	levietojiet ēdienu cepeškrāsnī. Apstipriniet iestatījumu.

6.5 Gatavošanas palīgs ar receptēm









Apzīmējumi	
	Ūdens daudzums tvaika funkcijas darbināšanai.
	Pirms ēdiena gatavošanas uzkaršējiet tukšu cepeškrāsnī.
	Plaukta līmenis.

Kad funkcija beidz darbību, pārbaudiet, vai ēdiens ir gatavs.













Ēdiena veids	Svars	Plaukta līmenis / papildpiederumi	Ilgums
Liellopu gaļa 🍖			























IZMANTOŠANA IKDIENĀ

	Ēdiena veids	Svars	Plaukta līmenis / papildpiederumi	Ilgums
P1	Liellopu gaļas cepetis, pusjēls	1–1,5 kg; 4–5 cm biezi gabali	☐ 2; cepamā paplāte Pāris minūtes apcepjiet gaļu karstā pannā. Ievietojiet to cepeškrāsnī.	40 min
P2	Liellopu gaļas cepetis, vidēji izcepts			50 min
P3	Liellopu gaļas cepetis, pilnībā izcepts			60 min
P4	Steiks, vidēji izcepts	180–220 g šķēles; 3 cm biezas	☐☐ 3; cepamais trauks uz restota plaukta Pāris minūtes apcepjiet gaļu karstā pannā. Ievietojiet to cepeškrāsnī.	15 min
P5	Cepta / sautēta gaļa (augstākā labuma ribiņas, ciska, pavēdere)	1,5–2 kg	☐ 2; cepamais trauks uz restota plaukta Pāris minūtes apcepjiet gaļu karstā pannā. Pievienojiet šķidrumu. Ievietojiet to cepeškrāsnī.	120 min
P6	Liellopu gaļas cepetis, pusjēls (lēnā gatavošana)	1–1,5 kg; 4–5 cm biezi gabali	☐ 2; cepamā paplāte Izmantojiet savas iecienītākās garšvielas vai vienkārši pievienojiet sāli un svaigi maltus piparus. Pāris minūtes apcepjiet gaļu karstā pannā. Ievietojiet to cepeškrāsnī.	75 min
P7	Liellopu gaļas cepetis, vidēji izcepts (lēnā gatavošana)			85 min
P8	Liellopu gaļas cepetis, pilnībā izcepts (lēnā gatavošana)			130 min



















	Ēdiena veids	Svars	Plaukta līmenis / papildpiederumi	Ilgums
P9	Fileja, pusjēla (lēnā gatavošana)	0,5–1,5 kg; 5–6 cm bieži gabali	 2; cepamā paplāte Izmantojiet savas iecienītākās garšvielas vai vienkārši pievienojiet sāli un svaigi maltus piparus. Pāris minūtes apcepiet gaļu karstā pannā. Ievietojiet to cepeškrāsnī.	75 min
P10	Fileja, vidēji izcepta (lēnā gatavošana)			90 min
P11	Fileja, pilnībā izcepta (lēnā gatavošana)			120 min
Teļa gaļa 				
P12	Teļa gaļas ceptis (piemēram, plecs)	0,8–1,5 kg; 4 cm bieži gabali	 2; cepamais trauks uz restota plaukta Izmantojiet savas iecienītākās garšvielas. Pievienojiet šķidrumu. Cepiet aplātu.	80 min
Cūkgaļa 				
P13	Cūkas kakla vai pleca ceptis	1,5–2 kg	 2; cepamais trauks uz restota plaukta Gatavošanas laika vidū apgrieziet gaļu otrādi.	120 min
P14	Plucināta cūkgaļa GZT	1,5–2 kg	 2; cepamā paplāte Izmantojiet savas iecienītākās garšvielas. Gatavošanas laika vidū apgrieziet gaļu otrādi, lai tā iegūtu vienlīdzīgu brūnumu.	215 min
P15	Mugura, svaiga	1–1,5 kg; 5–6 cm bieži gabali	 2; cepamais trauks uz restota plaukta Izmantojiet savas iecienītākās garšvielas.	55 min
P16	Cūkgaļas ribiņas	2–3 kg; izmantojiet jēlas, 2–3 cm plānas cūkgaļas ribiņas	 3; cepamā panna Pievienojiet šķidrumu, lai aplātu pannas apakšu. Gatavošanas laika vidū apgrieziet gaļu otrādi.	90 min
Jēra gaļa 				



IZMANTOŠANA IKDIENĀ

	Ēdiena veids	Svars	Plaukta līmenis / papildpiederumi	Ilgums
P17	Jēra kāja ar kaulu	1,5–2 kg; 7–9 cm bieži gabali	 2; cepamais trauks uz restota plaukta Pievienojiet šķidrumu. Gatavošanas laika vidū apgrieziet gaļu otrādi.	130 min
Putnu gaļa 				
P18	Vesela vista	1–1,5 kg; svaiga	 2;  200 ml; sautējamais trauks uz cepamās paplātes Izmantojiet savas iecienītākās garšvielas. Gatavošanas laika vidū apgrieziet gaļu otrādi, lai tā iegūtu vienlīdzīgu brūnumu.	60 min
P19	Vista, puse	0,5–0,8 kg	 3 ; cepamā paplāte Izmantojiet savas iecienītākās garšvielas.	40 min
P20	Vistas krūtiņa	katram gabalam 180–200 g	  2; cepamais trauks uz restota plaukta Izmantojiet savas iecienītākās garšvielas. Pāris minūtes apcepiet gaļu karstā pannā.	25 min
P21	Vistas stilbiņi, svaigi	-	 3; cepamā paplāte Ja vistas kājiņas ir iepriekš marinētas, iestatiet zemāku temperatūru un gatavojiet tās ilgāk.	30 min
P22	Pile, vesela	2–3 kg	 2; cepamais trauks uz restota plaukta Izmantojiet savas iecienītākās garšvielas. Ievietojiet gaļu cepamajā traukā. Gatavošanas laika vidū apgrieziet pili otrādi.	100 min
P23	Zoss, vesela	4–5 kg	 2; cepamā panna Izmantojiet savas iecienītākās garšvielas. Ievietojiet gaļu cepamajā paplātē. Gatavošanas laika vidū apgrieziet zosi otrādi.	110 min
Cits 				
P24	Gaļas rulete	1 kg	 2; restotais plaukts Izmantojiet savas iecienītākās garšvielas.	60 min

	Ēdiena veids	Svars	Plaukta līmenis / papildpiederumi	Ilgums
 Zivis				
P25	Vesela zivs, grilēta	0,5–1 kg katra zivs	 2; cepamā paplāte Pildiet zivi ar sviestu un izmantojiet savas iecienītākās garšvielas un garšaugus.	30 min
P26	Zivs fileja	-	  3; sautējuma trauks uz restotā plaukta Izmantojiet savas iecienītākās garšvielas.	20 min
Saldumi / deserti   				
P27	Siera kūka	-	 2;  28 cm kūkas veidne uz restotā plaukta	90 min
P28	Ābolu kūka	-	 2;  100–150 ml; cepamā paplāte	60 min
P29	Ābolu tarte	-	 2; pīrāgu veidne uz restotā plaukta	40 min
P30	Ābolu pīrāgs	-	 2;  100–150 ml;  22 cm pīrāgu veidne uz restotā plaukta	60 min
P31	Braunijs	2 kg	 3; cepamā panna	30 min
P32	Šokolādes mafini	-	 2;  100–150 ml; mafinu veidne uz restotā plaukta	30 min
P33	Kēkss	-	 2; kēksa veidne uz restotā plaukta	50 min
Dārzeni / piedevas   				
P34	Krāsni cepti kartupeļi	1 kg	 2; cepamā paplāte Novietojiet veselus nemizotus kartupeļus uz cepamās paplātes.	50 min





IZMANTOŠANA IKDIENĀ

	Ēdiena veids	Svars	Plaukta līmenis / papildpiederumi	Ilgums
P35	Daiviņas	1 kg	 3; cepamā paplāte pārklāta ar cepamo papīru Izmantojiet savas iecienītākās garšvielas. Sagrieziet kartupeļus gabaliņos.	35 min
P36	Grilēti jauktie dārzeņi	1–1,5 kg	 3; cepamā paplāte pārklāta ar cepamo papīru Izmantojiet savas iecienītākās garšvielas. Sagrieziet dārzeņus gabaliņos.	30 min
P37	Kroketes, saldētas	0,5 kg	 3; cepamā paplāte	25 min
P38	Kartupeļi, saldēti	0,75 kg	 3; cepamā paplāte	25 min
Sacepumi, maize un pica   				
P39	Lazanja / nūdeju sacepums	1–1,5 kg	 2; sautējuma trauks uz restotā plaukta	45 min
P40	Kartupeļu sacepums	1–1,5 kg	 1; sautējuma trauks uz restotā plaukta	50 min
P41	Svaiga pica, plānā	-	  2;  100 ml; cepamā paplāte pārklāta ar cepamo papīru	15 min
P42	Svaiga pica, biežā	-	  2;  100 ml; cepamā paplāte pārklāta ar cepamo papīru	25 min
P43	Kišs	-	 2; cepamā veidne uz restotā plaukta	45 min
P44	Bagete / čabata / baltmaize	0,8 kg	  3;  150 ml; cepamā paplāte pārklāta ar cepamo papīru Baltmaizei nepieciešams ilgāks laiks.	30 min

	Ēdiena veids	Svars	Plaukta līmenis / papildpiederumi	Ilgums
P45	Visu veidu graudu / rudzu / tumšā maize visu veidu graudu maizes veidnē	1 kg	  2;  150 ml; cepamā paplāte pārklāta ar cepamo papīru / restotais plaukts	45 min

7. PULKSTEŅA FUNKCIJAS

7.1 Pulksteņa funkcijas





Pulksteņa funkcija	Izmantošana
	Laika atgādinājums. Beidzoties iestatītajam laikam, atskan signāls.
	Gatavošanas laiks. Beidzoties iestatītajam laikam, atskan signāls un pārtrauc darboties karsēšanas funkcija.
	Atliktais starts. Ēdiena gatavošanas sākuma un/vai beigu atlikšana.
	Laika skaitīšana. Maksimālais ilgums ir 23 h 59 min. Šī funkcija neietekmē cepeškrāsns darbību. Lai ieslēgtu un izslēgtu Laika skaitīšana, atlasiet: Izvēlne, Iestatījumi kombinācija.

7.2 Pulksteņa funkcijas iestatīšana

Iestatīšana. Diennakts laiks		
1. solis.	2. solis	3. solis.
		
Lai mainītu diennakts laiku, atveriet izvēlni un atlasiet opciju Iestatīt diennakts laiku.	Iestatiet pulksteni.	Nospiediet OK.







PULKSTEŅA FUNKCIJAS

Iestatīšana. Laika atgādinājums

1. solis	Displejā redzams 0:00 	2. solis.	3. solis.
			
Nospiediet: 		Iestatiet Laika atgādinājums	Nospiediet OK.









 Taimeris nekavējoties uzsāk laika atskaiti.

Iestatīšana. Gatavošanas laiks

1. solis.	2. solis.	Displejā redzams 0:00 	3. solis.	4. solis
				
atlasiet karsēšanas funkciju un temperatūru.	Nospiediet atkārtoti 		Iestatiet gatavošanas laiku.	Nospiediet OK.

 Taimeris nekavējoties uzsāk laika atskaiti.

Iestatīšana. Atliktais starts

1. solis.	2. solis.	Displejā ir redzama jaunā iestatītā diennakts laika vērtība.  SĀKT	3. solis.	4. solis	Displejā redzams --:--  PĀRTRAUKT	5. solis.	6. solis
							
Atlasiet karsēšanas funkciju.	Nospiediet atkārtoti 		Iestatiet sākuma laiku.	Nospiediet OK.		Iestatiet beigu laiku.	Nospiediet OK.

Iestatīšana. Atliktais starts

 Taimeris uzsāk laika atskaiti iestatītajā sākuma laikā.

8. IZMANTOŠANA: PAPILDPIEDERUMI

8.1 Piederumu ievietošana

Neliela iedobe augšpusē palielina drošību. Šīs iedobes novērš arī trauku sasvēršanos. Augstā mala ap plauktu neļauj ēdiena gatavošanas traukiem slīdēt.

Restots plaukts:

Iebīdiet plauktu starp cepeškrāsns līmeņa vadotnes stieņiem.

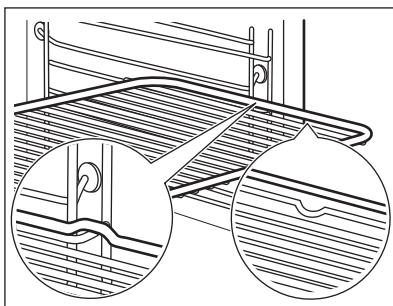

Cepamā Paplāte /Cepamā panna:

Iebīdiet cepamo paplāti starp plauktu atbalsta režģa vadotnēm.

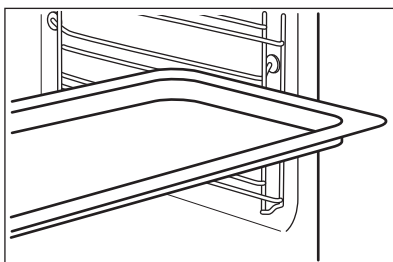

Restots plaukts, Cepamā Paplāte /Cepamā panna:

Iebīdiet cepamo paplāti starp plauktu atbalsta vadotnes stieņiem un restotā plaukta uz vadotnes stieņiem augstāk.

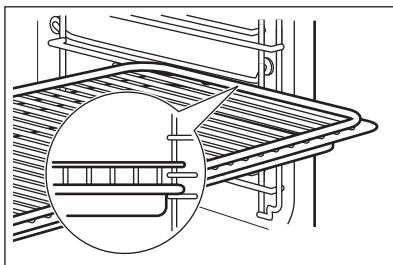

9. PAPILDFUNKCIJAS

9.1 Bloķēšana

Šī iespēja novērš nejaušas izmaiņas cepeškrāsns funkcijā.



Ieslēdziet to cepeškrāsns darbības laikā — iestatītā gatavošanas programma turpina darboties, vadības panelis ir bloķēts.

Ieslēdziet to laikā, kad cepeškrāsns ir izslēgta — cepeškrāsns nevar ieslēgt, vadības panelis ir bloķēts.





Nospiediet un turiet nospiestu , lai ieslēgtu funkciju.
Atskan signāls.

Nospiediet un turiet nospiestu , lai izslēgtu funkciju.

Mirgo  3 x , kad ir ieslēgta bloķēšana.

9.2 Automātiskā izslēgšanās

Drošības nolūkā cepeškrāsns izslēdzas pēc kāda laika, ja karsēšanas funkcija darbojas un jūs nemaināt nekādus iestatījumus.

 (°C)	 (h)
30 - 115	12.5
120 - 195	8.5
200 - 245	5.5
250 — maksimāli	3

Automātiskā izslēgšanās nedarbojas ar šādām funkcijām: Apgaismojums (lampa), Atliktais starts.

9.3 Dzesēšanas ventilators



Kad cepeškrāsns darbojas, dzesēšanas ventilators automātiski uztur cepeškrāsns virsmas vēsas. Izslēdzot cepeškrāsns, dzesēšanas ventilators var turpināt darboties, līdz cepeškrāsns atdziest.

10. PADOMI UN IETEIKUMI

10.1 Ventilatora kars. ar mitrumu



Labāka rezultāta gūšanai ievērojiet laikus, kas uzskaitīti tabulā.

Izmantojiet trešo plaukta līmeni.

	 (°C)	 (min.)
Makaronu sacepums	200 - 220	45 - 55
Kartupeļu sacepums	180 - 200	70 - 85
Musaka	170 - 190	70 - 95
Lazanja	180 - 200	75 - 90
Kaneloni	180 - 200	70 - 85
Maizes pudiņš	190 - 200	55 - 70
Rīsu pudiņš	170 - 190	45 - 60
Ābolu kūka ar biskvītķūkas mīklas maisījumu (apaļā kūkas veidne)	160 - 170	70 - 80
Baltmaize	190 - 200	55 - 70

10.2 Ventilatora kars. ar mitrumu - ieteicamie piederumi

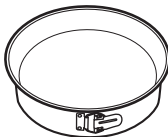
Lietojiet tumšas krāsas un neatstarojošas formas un traukus. Tiem ir labāka siltuma absorbēšanas spēja nekā gaišas krāsas un atstarojošiem traukiem.

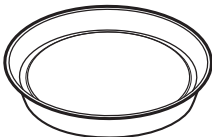
			
Picas panna	Cepšanas trauks	Podiņi	Augļu pīrāga forma
Tumša, neatstarojoša 28 cm diametrs	Tumša, neatstarojoša 26 cm diametrs	Keramikas 8 cm diametrs, 5 cm augstums	Tumša, neatstarojoša 28 cm diametrs

10.3 Gatavošanas tabulas pārbaudes iestādēm





Informācija pārbaudes iestādēm

Pārbaudes saskaņā ar: EN 60350, IEC 60350.

PADOMI UN IETEIKUMI



CEPŠANA VIENĀ LĪMENĪ. Cepšana formās





		 (°C)	 (min.)	
Biskvītkūka bez taukvielām	Karsēšana ar ventilatoru	140 - 150	35 - 50	2
Biskvītkūka bez taukvielām	Augš./Apakškarsēšana	160	35 - 50	2
Ābolu pīrāgs, 2 veidnes Ø20 cm	Karsēšana ar ventilatoru	160	60 - 90	2
Ābolu pīrāgs, 2 veidnes Ø20 cm	Augš./Apakškarsēšana	180	70 - 90	1



CEPŠANA VIENĀ LĪMENĪ. Cepumi







Izmantojiet trešo plaukta līmeni.

		 (°C)	 (min.)
Smilšu mīkla / Mīklas lokšnes	Karsēšana ar ventilatoru	140	25 - 40
Smilšu mīkla / Mīklas lokšnes, uzkaršējiet tukšu cepeškrāsni	Augš./Apakškarsēšana	160	20 - 30
Kūciņas, 20 paplātē, uzkaršējiet tukšu cepeškrāsni	Karsēšana ar ventilatoru	150	20 - 35
Kūciņas, 20 paplātē, uzkaršējiet tukšu cepeškrāsni	Augš./Apakškarsēšana	170	20 - 30



CEPŠANA DAUDZOS LĪMEŅOS Cepumi

		 (°C)	 (min.)	
Smilšu mīkla / Mīklas loksnes	Karsēšana ar ventilato- ru	140	25 - 45	1 / 4
Kūciņas, 20 paplātē, uz- karsējiet tukšu cepeškrās- ni	Karsēšana ar ventilato- ru	150	23 - 40	1 / 4
Biskvītkūka bez taukvie- lām	Karsēšana ar ventilato- ru	160	35 - 50	1 / 4







GRILS



Iepriekš uzsildiet tukšu cepeškrāsni 5 minūtes.



Grils ar maksimālās temperatūras iestatījumu.

		 (min.)	
Karstmaize	Grils	1 - 3	5
Liellopa steiks, gatavošanas laika vidū apgrieziet	Grils	24 - 30	4



11. KOPŠANA UN TĪRĪŠANA



BRĪDINĀJUMS!

Skatiet sadaļu "Drošība".

11.1 Piezīmes par tīrīšanu

 Tīrīšanas līdzekļi	Tīriet cepeškrāsns priekšpusi ar mīkstu drāniņu, kas iemērcta siltā ūdenī ar saudzīgu mazgāšanas līdzekli.
	Metāla virsmu tīrīšanai izmantojiet tīrīšanas šķīdumu.
	Traipu tīrīšanai izmantojiet saudzīgu mazgāšanas līdzekli.
 Lietošana ikdienā	Tīriet cepeškrāsns iekšieni pēc katras lietošanas reizes. Tauku vai citu pārtikas palieku uzkrāšanās var izraisīt ugunsgrēku.
	Neuzglabājiet ēdienu cepeškrāsnī ilgāk par 20 minūtēm. Nosusiniet cepeškrāsns iekšieni ar mīkstu drānu pēc katras lietošanas reizes.
 Papildpiederumi	Notīriet visus papildpiederumus pēc katras lietošanas un ļaujiet tiem nožūt. Lietojiet mīkstu drānu, kas iemērcta siltā ūdenī ar saudzīgu mazgāšanas līdzekli. Nemazgājiet papildpiederumus trauku mazgājamajā mašīnā.
	Netīriet piedegumdrošos papildpiederumus ar abrazīviem tīrīšanas līdzekļiem vai asiem priekšmetiem.

11.2 Kā tīrīt? Tilpnes reljefs

Iztīriet cepeškrāsns tilpni, lai likvidētu kaļķakmens nogulsnes pēc gatavošanas ar tvaiku.

1. solis.	2. solis	3. solis.
Ielejiet cepeškrāsns tilpnes reljefā 250 ml etiķa. Lietojiet bezpiedevu etiķi, kura koncentrācijas līmenis nepārsniedz 6 %.	Ļaujiet etiķim izšķīdināt kaļķakmens nogulsnes 30 minūtes istabas temperatūrā.	Tīriet cepeškrāsns tilpni ar silta ūdeni un mīkstu drānu.
Funkcijai: SteamBake tīriet cepeškrāsns iekšpusi ik pēc 5–10 gatavošanas cikliem.		

11.3 Kā izņemt: Plauktu balsti

Izņemiet plauktu balstus, lai iztīrītu cepeškrāsns iekšpusi.

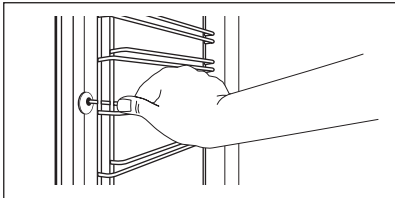
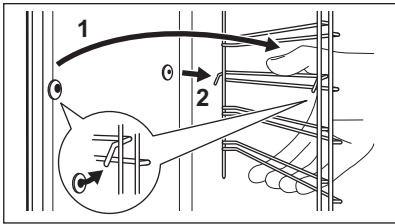
1. solis	Izslēdziet cepeškrāsni un nogaidiet, līdz tā ir atdzisusi.	
2. solis	Pavelciet plauktu atbalstu priekšējo daļu nost no sānu sienas.	
3. solis	Pavelciet plauktu balstu aizmugurējo daļu nost no sānu sienas un izņemiet to.	
4. solis	Uzstādiet plauktu balstus, veicot iepriekšminētās darbības pretējā secībā. Teleskopisko vadotņu fiksatoriem jābūt vēršiem ierīces priekšpusē virzienā.	

11.4 Funkcijas Pirolītiskā tīrīšana izmantošana

Tīriet cepeškrāsni ar Pirolītiskā tīrīšana.



BRĪDINĀJUMS!

Pastāv apdedzināšanās risks.



UZMANĪBU!

Ja tajā pašā virtuves skapī ir uzstādītas citas ierīces, nelietojiet tās, kad darbojas šī funkcija. Tas var radīt cepeškrāsns bojājumus.



Pirms Pirolītiskā tīrīšana:

Izslēdziet cepeškrāsni un uzgaidiet, līdz tā atdziest.	Izņemiet no cepeškrāsns visus piederumus un izņemamos plauktu balstus.	Notīriet cepeškrāsns iekšējo apakšējo virsmu un durvju stikla iekšpusi ar siltu ūdeni, mīkstu drānu un maigu tīrīšanas līdzekli.
--	--	--

Pirolītiskā tīrīšana

1. solis	Ieejiet izvēlnē: Tīrīšana $\text{mm} /$.	
	Iespēja	Darb. laiks
	C1 - Viegla tīrīšana	1 h
	C2 - Vidēji intensīva tīrīšana	1 h 30 min

KOPŠANA UN TĪRĪŠANA

Pirolītiskā tīrīšana	
C3 - Padziļināta tīrīšana	3 h
2. solis.	OK — nospiediet, lai atlasītu tīrīšanas programmu.
3. solis.	Nospiediet OK, lai uzsāktu tīrīšanu.
4. solis.	Pēc tīrīšanas pagrieziet karsēšanas funkciju pārslēgu izslēgtā pozīcijā.
 Tīrīšanas laikā cepeškrāsns lampa ir izslēgta.	
Kad cepeškrāsns ir iestatīta noteiktā temperatūrā, durvis bloķējas. Līdz durvju bloķēšanai displejā tiek rādīts:  .	

Kad tīrīšana beidzas:		
Izslēdziet cepeškrāsni un uzgaidiet, līdz tā atdziest.	Izīriet cepeškrāsns iekšieni ar mīkstu drānu.	Noīriet atlikumus no cepeškrāsns apakšējās virsmas.

11.5 Tīrīšanas atgādinājums

Cepeškrāsns atgādina jums, kad jāveic pirolītiskā tīrīšana.	
 mirgo displejā 5 sekundes pēc katras gatavošanas reizes.	Lai izslēgtu atgādinājumu, ievadiet Izvēlne un atlasiet Iestatījumi, Tīrīšanas atgādinājums.

11.6 Izņemšana un uzstādīšana: Durvis

Lai notīrītu durvis un iekšējos stikla paneļus, jūs varat tās atvienot no ierīces. Dažādiem ierīces modeļiem ir atšķirīgs stikla paneļu skaits.

	BRĪDINĀJUMS! Durvis ir smagas.
--	--

	UZMANĪBU! Apejieties ar stiklu uzmanīgi, jo īpaši priekšējā paneļa malu tuvumā. Stikls var saplīst.
--	---

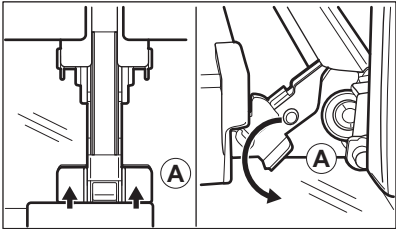
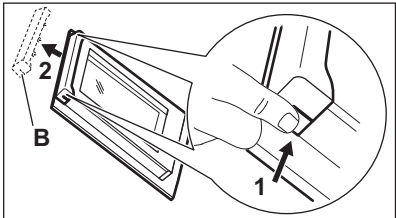
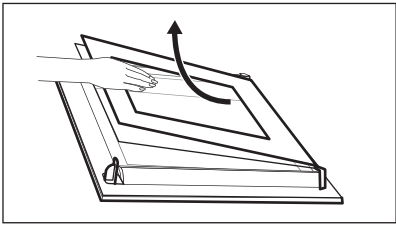
1. solis	Atveriet durvis līdz galam.	
2. solis	Paceliet un piespiediet abu durvju eņģu stiprinājuma sviras (A).	
3. solis	Aizveriet cepeškrāsns durvis līdz pirmajai atvēršanas pozīcijai (aptuveni 70° leņķī). Satveriet durvis no abām pusēm un pavelciet tās augšup virzienā no cepeškrāsns. Novietojiet durvis uz cietas virsmas, kas pārklāta ar mīkstu drānu, tā, lai ar drānu saskartos to ārpusē.	
4. solis	Turiet durvju augšdaļā esošo apmali (B) no abām pusēm un bīdiet to iekšup vērsta virzienā, lai atbrīvotu spraudņa blīvi.	
5. solis	Pavelciet durvju apmali uz priekšu, lai to izceltu.	
6. solis	Turiet durvju stikla paneļus aiz to augšējās malas un velciet tos ārā no vadotnēm vienu pēc otra virzienā uz augšu.	
7. solis	Notīriet stikla paneļus ar ūdeni un ziepēm. Uzmanīgi nosusiniet stikla paneli. Nemazgājiet stikla paneļus trauku mazgājamajā mašīnā.	
8. solis	Pēc tīrīšanas veiciet iepriekš minētās darbības apgrieztā secībā.	
9. solis	Vispirms uzstādiēt mazāko paneli, pēc tam lielāko paneli un durvis. Pārliecinieties, ka stikli ir ievietoti pareizi – pretējā gadījumā durvju virsma var pārkarst.	

11.7 Kā nomainīt: Lampa



BRĪDINĀJUMS!

Elektrošoka risks.

Lampa var būt karsta.

PROBLĒMRISINĀŠANA

Pirms nomaināt lampu:

1. solis	2. solis	3. solis
Izslēdziet cepeškrāsni. Uzgaidiet, līdz cepeškrāsns ir atdzīsusi.	Atslēdziet cepeškrāsni no elektrotīkla.	Iekļājiet uz tilpnes grīdas drānu.

Augšējā lampa

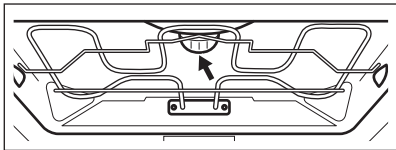
1. solis	Pagrieziet stikla pārsegu, lai to izņemtu.	
2. solis	Notīriet stikla pārsegu.	
3. solis	Nomainiet cepeškrāsns lampu ar piemērotu 300 °C siltumizturīgu cepeškrāsns lampu.	
4. solis	Uzlieciet stikla pārsegu.	

12. PROBLĒMRISINĀŠANA



BRĪDINĀJUMS!
Skatiet sadaļu "Drošība".

12.1 Kā rīkoties, ja...

Tabulā neiekļautu problēmu gadījumā sazinieties ar pilnvarotu servisa centru.



Cepeškrāsns neieslēdzas un/vai nesakarst

Problēma	Pārbaudiet, vai:
Nevar ieslēgt vai lietot cepeškrāsni.	Cepeškrāsns ir pareizi pieslēgta strāvas padevei.
Cepeškrāsns neuzsilst.	Deaktivizēta automātiskās izslēgšanās funkcija.
Cepeškrāsns neuzsilst.	Cepeškrāsns durvis ir aizvērtas.



Cepeškrāsns neieslēdzas un/vai nesakarst

Cepeškrāsns neuzsilst.	Izdedzis drošinātājs.
Cepeškrāsns neuzsilst.	Bērnu drošības funkcija ir izslēgta.



Detājas

Problēma	Pārbaudiet, vai:
Apgaismojums ir izslēgts.	Ieslēgta funkcija Ventilatora kars. ar mitrumu.
Nestrādā lampiņa.	Spuldze ir izdegusi.



Kļūdu kodi

Displejā redzams...	Pārbaudiet, vai:
Err C3	Cepeškrāsns durvis ir aizvērtas vai durvju bloķētājs nav bojāts.
Err F102	Cepeškrāsns durvis ir aizvērtas.
Err F102	Durvju bloķētājs nav bojāts.
00:00	Noticis strāvas padeves pārrāvums. Iestatiet diennakts laiku.

Ja displejā redzams šajā tabulā neiekļauts kļūdas kods, izslēdziet mājojka elektrosistēmas drošinātāju un atkārtoti ieslēdziet cepeškrāsni. Ja kļūdas kods atkārtoti parādās displejā, sazinieties ar autorizēto servisa centru.



Tīrīšana

Problēma	Pārbaudiet, vai:
No cepeškrāsns tilpnes reljefa tek ūdens.	Cepeškrāsns tilpnes reljefā ir pārāk daudz ūdens.

ENERGOEFEKTIVĀTE

12.2 Apkopes dati

Ja nevarat atrast risinājumu, sazinieties ar ierīces tirgotāju vai pilnvarotu servisa centru. Servisa centram nepieciešamie dati norādīti uz tehnisko datu plāksnītes. Tehnisko datu plāksnīte atrodas cepeškrāsns iekšpusē uz priekšējā rāmja. Nenoņemiet cepeškrāsns iekšpusē esošo tehnisko datu plāksnīti.

Iesakām pierakstīt datus šeit:	
Ierīces modeļa nosaukums (MOD.)
Izstrādājuma numurs (PNC)
Sērijas numurs (S.N.)

13. ENERGOEFEKTIVĀTE

13.1 Produkta informācija un produkta informācijas lapa*

Ražotāja nosaukums	AEG	
Modeļa identifikācija	BPB351160M 944188506 BPS351160M 944188507	
Energoefektivitātes indekss	81.2	
Energoefektivitātes klase	A+	
Enerģijas patēriņš ar standarta devu, tradicionālais režīms	1.09 kWh/ciklā	
Enerģijas patēriņš ar standarta devu, piespiedu ventilācijas režīms	0.69 kWh/ciklā	
Tilpņu skaits	1	
Siltuma avots	Elektrība	
Tilpums	71 l	
Cepeškrāsns veids	Iebūvējama cepeškrāsns	
Masa	BPB351160M	34.0 kg
	BPS351160M	34.0 kg

* Eiropas Savienībai saskaņā ar ES Regulām 65/2014 un 66/2014.
Baltkrievijas Republikai saskaņā ar STB 2478-2017, G pielikums; STB 2477-2017, A un B pielikums.
Ukrainai saskaņā ar 568/32020.

Energoefektivitātes klase neattiecas uz Krieviju.

EN 60350-1 - Elektriskās mājāsaimniecības ierīces ēdiena gatavošanai. 1. daļa: Plītis, cepeškrāsnis, tvaika cepeškrāsnis un grili. Veiktspējas mērīšanas metodes.

13.2 Elektroenerģijas taupīšana



Cepeškrāsnis ir aprīkota ar funkcijām, kas ļauj taupīt elektroenerģiju, gatavojot maltītes ikdienā.

Cepeškrāsnis darbības laikā tās durvīm jābūt aizvērtām. Gatavošanas laikā neviriniet cepeškrāsnis durvis pārāk bieži. Raugieties, lai durvju blīve būtu tīra, un gādājiet, lai tā būtu labi nofiksēta savā pozīcijā.

Izmantojiet metāla traukus, lai uzlabotu elektroenerģijas taupīšanu.

Kad iespējams, neuzsildiet cepeškrāsnī pirms gatavošanas.

Uzturiet pēc iespējas īsākus pārtraukumus starp cepšanas reizēm, ja gatavojat vairākus ēdienus vienā piegājienā.

Gatavošana ar ventilatoru

Ja iespējams, elektroenerģijas taupīšanas nolūkā izmantojiet gatavošanas funkcijas.

Atlikušais siltums

Ventilators un lampa turpina darboties. Izslēdzot cepeškrāsnī, displejā tiek attēlots atlikušais siltums. Jūs varat izmantot atlikušo siltumu, lai uzturētu ēdiena siltu.

Ja gatavošanas ilgums pārsniedz 30 minūtes, samaziniet cepeškrāsnis temperatūru līdz minimumam 3–10 minūtes pirms gatavošanas laika beigām. Cepeškrāsnī atlikušais siltums turpinās gatavot tajā ievietoto ēdianu.

Izmantojiet atlikušo cepeškrāsnis siltumu, lai uzsildītu ēdianu.

Ēdiena siltuma uzturēšana

Izvēlieties zemāko iespējamo temperatūras iestatījumu, lai izmantotu atlikušo siltumu un saglabātu ēdianu siltu. Atlikušā siltuma indikators vai temperatūra tiek parādīta displejā.

Gatavošana ar izslēgtu cepeškrāsnis apgaismojumu

Gatavošanas laikā izslēdziet cepeškrāsnis apgaismojumu. Ieslēdziet to tikai tad, kad nepieciešams.

Ventilatora kars. ar mitrumu

Šī funkcija paredzēta enerģijas taupīšanai gatavošanas laikā.

Izmantojot šo funkciju, apgaismojums automātiski izslēdzas pēc 30 sekundēm. Jūs varat to ieslēgt atkārtoti, taču šī darbība samazinās paredzamo elektroenerģijas ietaupījumu.



14. IZVĒLNES STRUKTŪRA





14.1 Izvēlne



— atlasiet, lai ievadītu Izvēlne.

IZVĒLNES STRUKTŪRA

Izvēlne struktūra		
Gatavošanas palīgs 	Tīrīšana 	Iestatījumi 

1. solis.	2. solis	3. solis	4. solis	5. solis.
	 OK	 O1–O11	 OK	
Atlasiet Izvēlne, iestatījumi.	Apstipriniet iestatījumu.	Atlasiet iestatījumu.	Apstipriniet iestatījumu.	Pielāgojiet vērtību un nospiediet OK.

Iestatījumi					
O1	Diennakts laiks	Mainīt	O2	Displeja spilgtums	1 - 5
O3	Taustiņu skaņa	1 — pīkstiens 2 — klikšķis 3 — skaņa izslēgta	O4	Skaņas signāla skaļums	1 - 4
O5	Laika skaitīšana	Ieslēgt/ Izslēgt	O6	Apgaismojums (lampa)	Ieslēgt/Izslēgt
O7	Ātrā uzsīšana	Ieslēgt/ Izslēgt	O8	Tīrīšanas atgādinājums	Ieslēgt/Izslēgt
O9	Demonstrācijas režīms	Aktivizācijas kods: 2468	O10	Programmatūras versija	Pārbaude
O11	Nodzēst visus iestatījumus	Jā / Nē			

15. APSVĒRUMI PAR VIDES AIZSARDZĪBU

Nododiet otrreizējai pārstrādei materiālus ar simbolu . Ievietojiet iepakojuma materiālus atbilstošajos konteineros to otrreizējai pārstrādei. Palīdziet aizsargāt apkārtējo vidi un cilvēku veselību, atkārtoti pārstrādājot elektrisko un elektronisko iekārtu atkritumus. Neizmetiet ierīces,

kas apzīmētas ar šo simbolu , kopā ar mājsaimniecības atkritumiem. Nododiet izstrādājumu vietējā otrreizējās pārstrādes punktā vai sazinieties ar vietējo pašvaldību.

PUIKIEMS REZULTATAMS

Ačiū, kad pasirinkote šį AEG gaminį. Mes jį sukūrėme taip, kad nepriekaištingai veiktų daugelį metų – jame naudojamos pažangios technologijos ir naudingos unikalios funkcijos, kurios palengvins jūsų kasdienybę. Skirkite kelias minutes šiai instrukcijai perskaityti, kad pasinaudotumėte visais joje pateiktais patarimais.

Apsilankykite mūsų interneto svetainėje.



Čia rasite naudojimo patarimų, brošiūrų, informacijos apie triukščių šalinimą, aptarnavimą ir remontą:

www.aeg.com/support



Užregistruokite savo gaminį ir naudokitės papildomomis paslaugomis:

www.registreaeg.com



Jūsų prietaisui skirtų priedų, nusidėvinčių ir originalių atsarginių dalių ieškokite čia:

www.aeg.com/shop



Daugiau receptų, patarimų, nurodymų dėl triukščių ir kitos informacijos rasite **My AEG Kitchen** programėlėje.



KLIENTŲ APTARNAVIMAS IR TECHNINĖ PRIEŽIŪRA

Visada naudokite originalias atsargines dalis.

Kreipdamiesi į įgaliotąjį aptarnavimo centrą išitikinkite, kad galite nurodyti šią informaciją: prietaiso modelis, PNC, serijos numeris.

Šią informaciją galima rasti techninių duomenų plokštėje.

 Įspėjimo / perspėjimo ir saugos informacija

 Bendroji informacija ir patarimai

 Aplinkosaugos informacija

Galimi pakeitimai.

TURINYS

1. SAUGOS INFORMACIJA.....	293	2.5 Piroлизinis valymas.....	298
1.1 Vaikų ir pažeidžiamų žmonių sauga.....	293	2.6 Vidinis apšvietimas.....	298
1.2 Bendrieji saugos reikalavimai.....	294	2.7 Aptarnavimas.....	298
2. SAUGOS INSTRUKCIJOS.....	295	2.8 Šalinimas.....	299
2.1 Įrengimas.....	295	3. GAMINIO APRAŠYMAS.....	299
2.2 Elektros prijungimas	296	3.1 Bendroji apžvalga.....	299
2.3 Naudojimas.....	297	3.2 Priedai.....	300
2.4 Priežiūra ir valymas.....	297		

4. KAIP ĮJUNGTI IR IŠJUNGTI ORKAITĘ..	300	10. PATARIMAI.....	315
4.1 Įstumiamos rankenėlės.....	300	10.1 Drėgnas konvek. kepimas.....	315
4.2 Valdymo skydelis.....	301	10.2 Drėgnas konvek. kepimas –	
5. PRIEŠ NAUDODAMI PIRMĄ KARTĄ.....	302	rekomenduojami priedai.....	316
5.1 Pirminis valymas.....	302	10.3 Maisto gaminimo lentelės patikros	
5.2 Pirminis pašildymas.....	302	įstaigoms.....	316
6. KASDIENIS NAUDOJIMAS.....	302	11. VALYMAS IR PRIEŽIŪRA.....	318
6.1 Kaip nustatyti Kaitinimo funkcijos	303	11.1 Pastabos dėl valymo.....	319
6.2 Kaitinimo funkcijos.....	304	11.2 Kaip valyti įduba vandeniui.....	319
6.3 Pastabas matysite Drėgnas		11.3 Kaip pašalinti: Lentynų atramos	319
konvek. kepimas.....	305	11.4 Kaip naudoti:	
6.4 Kaip nustatyti Kepimo vadovas.....	305	Pirrolizinis valymas.....	320
6.5 Kepimo vadovas su receptais.....	306	11.5 Priminimas apie valymą.....	321
7. LAIKRODŽIO FUNKCIJOS.....	311	11.6 Kaip išimti ir įdėti: Durelės.....	321
7.1 Laikrodžio funkcijos.....	312	11.7 Kaip pakeisti: Lemputė.....	322
7.2 Kaip nustatyti		12. TRIKČIŲ ŠALINIMAS.....	323
Laikrodžio funkcijos.....	312	12.1 Ką daryti, jeigu.....	323
8. KAIP NAUDOTI: PRIEDAI.....	313	12.2 Aptarnavimo duomenys.....	325
8.1 Priedų įstatymas.....	313	13. ENERGIJOS EFEKTYVUMAS.....	325
9. PAPILDOMOS FUNKCIJOS.....	314	13.1 Informacija apie gaminį ir	
9.1 Užraktas.....	314	informacijos apie gaminį lapas*.....	325
9.2 Automatinis išsijungimas.....	315	13.2 Energijos taupymas.....	326
9.3 Aušinimo ventiliatorius.....	315	14. MENIU STRUKTŪRA.....	326
		14.1 Meniu.....	327

1. ⚠ SAUGOS INFORMACIJA

Prieš įrengdami ir naudodami šį prietaisą, atidžiai perskaitykite pateiktą instrukciją. Gamintojas neatsako už sužalojimus ar žalą, patirtą dėl netinkamo prietaiso įrengimo ar naudojimo. Instrukciją visada laikykite saugioje ir pasiekiamoje vietoje, kad prareikus galėtumėte pasižiūrėti.

1.1 Vaikų ir pažeidžiamų žmonių sauga

- Vyresni nei 8 metų vaikai ir asmenys, turintys fizinių, jutiminių arba protinių sutrikimų, arba asmenys, kuriems trūksta patirties ar žinių, šį prietaisą gali naudoti tik prižiūrimi kitų arba gavę nurodymus, kaip saugiai naudotis prietaisu, jei jie supranta su prietaiso naudojimu susijusius pavojus. Mažesnių nei 8 metų vaikų ir asmenų, turinčių labai sunkią ir

sudėtingą negalią, negalima be priežiūros leisti būti šalia prietaiso.

- Būtina visą laiką prižiūrėti vaikus ir užtikrinti, kad jie nežaistų su šiuo buitiniu prietaisu.
- Visas pakuotės medžiagas saugokite nuo vaikų ir tinkamai pašalinkite.
- DĖMESIO! Neleiskite vaikams ir naminiams gyvūnams būti šalia prietaiso jam veikiant arba vėstant. Prietaiso dalys naudojimo metu gali stipriai įkaisti.
- Jeigu prietaise yra apsaugos nuo vaikų įtaisai, jį reikia suaktyvinti.
- Vaikai be priežiūros negali atlikti prietaiso valymo ir naudotojo priežiūros darbų.

1.2 Bendrieji saugos reikalavimai

- Šį prietaisą įrengti ir pakeisti jo laidą privalo tik kvalifikuotas specialistas.
- Nenaudokite prietaiso, prieš jo įrengimą balduose.
- Prieš vykdydami techninės priežiūros darbus, atjunkite prietaisą nuo maitinimo.
- Jei būtų pažeistas maitinimo laidas, jį leidžiama keisti tik gamintojui, jo įgaliotajam techninės priežiūros centrui arba panašios kvalifikacijos asmenims – antraip gali kilti elektros pavojus.
- ĮSPĖJIMAS! Norėdami išvengti galimo elektros smūgio, pasirūpinkite, kad prieš keičiant lemputę prietaisas būtų išjungtas.
- ĮSPĖJIMAS! Prietaisas ir jo pasiekiamos dalys naudojimo metu įkaista. Būkite atsargūs, kad neprisiliestumėte prie kaitinimo elementų.
- Pagalbinis reikmenis arba orkaitės prikaistuvius iš orkaitės traukite ir į ją dėkite mūvėdami karščiui atsparias pirštines.

- Norėdami išimti lentynos atramas, pirmiausia patraukite lentynos atramos priekį, o po to galą nuo šoninių sienelių. Įdėkite lentynos atramas atvirkščia tvarka.
- Nenaudokite garintuvo prietaisui valyti.
- Durelių stiklo nevalykite šiurkščiu šveičiamuoju valikliu ar aštriomis metalinėmis grandyklėmis, nes galite subraižyti paviršių ir dėl to stiklas gali sudužti.
- Prieš pirolizinį valymą reikia išvalyti išsiliejimus. Išimkite visas dalis iš orkaitės.

2. SAUGOS INSTRUKCIJOS

2.1 Įrengimas



ISPĖJIMAS!

Šį prietaisą įrengti privalo tik kvalifikuotas asmuo.

- Nuimkite visas pakavimo medžiagas.
- Neįrenkite ir nenaudokite sugadinto prietaiso.
- Vadovaukitės su prietaisu pateiktomis įrengimo instrukcijomis.
- Visada būkite atsargūs, kai perkeliate prietaisą, nes jis yra sunkus. Visada mūvėkite apsaugines pirštines ir avėkite uždara avalynę.
- Netraukite šio prietaiso už rankenos.
- Įrenkite prietaisą saugioje ir tinkamoje vietoje, atitinkančioje įrengimo reikalavimus.
- Būtina paisyti minimalių atstumų iki kitų prietaisų ir spintelėlių.
- Prieš montuodami prietaisą patikrinkite, ar orkaitės dureles galite laisvai atidaryti.
- Prietaise įrengta elektrinė aušinimo sistema. Ji turi būti prijungta prie elektros maitinimo šaltinio.
- Įmontuojamasis prietaisas privalo atitikti standarte DIN 68930 numatytus stabilumo reikalavimus.

Minimalus spintelės aukštis (po darbataliu)	578 (600) mm
Spintelės plotis	560 mm
Spintelės gylis	550 (550) mm
Prietaiso priekinės dalies aukštis	594 mm
Prietaiso galinės dalies aukštis	576 mm
Prietaiso priekinės dalies plotis	595 mm
Prietaiso galinės dalies plotis	559 mm

Prietaiso gylis	567 mm
Prietaiso įmontavimo gylis	546 mm
Gylis su atidarytomis durelėmis	1027 mm
Minimalus ventiliacijos angos dydis. Anga prietaiso nugarėlės apačioje	560 x 20 mm
Pagrindinio maitinimo kabelio ilgis. Kabelis yra prietaiso nugarėlės dešiniajame kampe	1500 mm
Montavimo varžtai	4 x 25 mm

2.2 Elektros prijungimas



ĮSPĖJIMAS!

Gaisro ir elektros smūgio pavojus.

- Visus elektros prijungimus privalo atlikti kvalifikuotas elektrikas.
- Prietaisą privaloma įžeminti.
- Įsitikinkite, kad parametrai techninių duomenų plokštelėje atitinka maitinimo tinklo elektros vardinius duomenis.
- Visada naudokite tinkamai įrengtą įžemintą saugųjį elektros lizdą.
- Nenaudokite daugiakanalių adapterių ir ilginamųjų laidų.
- Būkite atsargūs, kad nesugadintumėte elektros kištuko ir maitinimo laido. Jei reikėtų pakeisti maitinimo laidą, tai turi padaryti mūsų įgaliojasis techninės priežiūros centras.
- Saugokite, kad maitinimo laidai nelieštų ir nebūtų arti prietaiso durelių arba nišos po prietaisu, ypač kai jis veikia arba durelės yra karštos.
- Dalių su įtampa ir izoliuotų dalių apsauga nuo smūgių turi būti pritvirtinta taip, kad nebūtų galima nuimti be įrankių.
- Elektros kištuką į tinklo lizdą junkite tik tuomet, kai visiškai pabaigsite įrengimą. Įsitikinkite, kad įrengus prietaisą, elektros laido kištuką būtų lengva pasiekti.
- Jeigu tinklo lizdas atsilaisvinęs, nejunkite kištuko.
- Norėdami išjungti prietaisą, netraukite už maitinimo laido. Visada traukite paėmę už elektros kištuko.
- Naudokite tik tinkamus izoliavimo įtaisus: liniją apsaugančius automatinius jungiklius, saugiklius (įskami saugikliai turi būti išimami iš jų laikiklio), įžeminimo nuotėkio atjungiamuosius įtaisus ir kontaktorius.
- Elektros instaliacija privalo turėti izoliavimo įtaisą, kuris leidžia atjungti prietaisą nuo maitinimo tinklo ties visais poliais. Tarp izoliavimo įtaiso kontaktų turi būti mažiausiai 3 mm pločio tarpelis.
- Iki galo uždarykite prietaiso dureles, prieš įkišdami maitinimo laido kištuką į elektros tinklo lizdą.
- Prietaisas tiekiamas su pagrindiniu maitinimo laidu ir kištuku.

2.3 Naudojimas



ĮSPĖJIMAS!

Sužalojimo, nudegimų ir elektros smūgio arba sprogimo pavojus.

- Šis buitinis prietaisas skirtas naudoti tik vidaus sąlygomis.
- Nebandykite pakeisti šio prietaiso techninių savybių.
- Pasirūpinkite, kad ventiliacinės angos nebūtų užblokuotos.
- Nepalikite įjungto prietaiso be priežiūros.
- Po kiekvieno naudojimo prietaisą išvalykite.
- Atidarydami veikiančio prietaiso dureles būkite atsargūs. Iš vidaus gali išsiveržti įkaitintas oras.
- Nelieskite prietaiso drėgnomis rankomis arba jei prietaisas liečiasi su vandeniu.
- Nespauskite atidarytų durelių.
- Nenaudokite prietaiso, kaip darbinio paviršiaus ar daiktams laikyti.
- Atsargiai atidarykite prietaiso dureles. Naudojant maisto produktus su alkoholiu, gali susidaryti alkoholio ir oro mišinys.
- Atidarydami dureles pasirūpinkite, kad šalimais nebūtų kibirkščių ar atviros ugnies šaltinių.
- Šalia prietaiso, į prietaisą arba ant jo nedėkite degių medžiagų arba degiomis medžiagomis sudrekinėtų daiktų.



ĮSPĖJIMAS!

Pavojus sugadinti prietaisą.

- Emalės apsauga nuo pažeidimų ir išblukimo:
 - Nedėkite orkaitėms skirtų indų ar kitų objektų tiesiai ant prietaiso dugno.
 - Nedėkite aliuminio folijos tiesiai ant prietaiso ertmės dugno;
 - Nepilkite vandens tiesiai į įkaitusį prietaisą.
 - Nelaikykite prietaise paruoštų drėgnų patiekalų ir maisto produktų.
 - Būkite atsargūs montuodami arba išimdami prietaiso priedus.
- Emalio ar nerūdijančio plieno išblukimas neturi poveikio prietaiso veikimui.
- Drėgniems pyragams kepti naudokite gilų kepimo indą. Vaisių sultys palieka dėmes, kurias sudėtinga pašalinti.
- Šis prietaisas yra skirtas tik maistui gaminti. Naudokite prietaisą tik pagal paskirtį, pavyzdžiui, nenaudokite prietaiso kambariui šildyti.
- Maistą visuomet ruoškite su uždarytomis orkaitės durelėmis.
- Jeigu prietaisas įrengtas už baldo plokštės (pvz., durelių), pasirūpinkite, kad prietaisui veikiant durelės visada būtų atidarytos. Už durelių gali kauptis karštis ir drėgmė, kurie gali pakenkti prietaisui, baldams ar grindims. Neuždarykite durelių, kol po naudojimo prietaisas visiškai neatauš.

2.4 Priežiūra ir valymas



ĮSPĖJIMAS!

Sužalojimo, gaisro arba prietaiso sugadinimo pavojus.

- Prieš atlikdami priežiūros darbus, išjunkite prietaisą ir ištraukite maitinimo laido kištuką iš elektros tinklo lizdo.
- Patikrinkite, ar prietaisas atvėsęs. Gali sutrūkti stiklo plokštės.
- Nedelsdami pakeiskite durelių stiklo plokštės, jeigu jos pažeistos. Kreipkitės į įgaliotąjį techninės priežiūros centrą.

SAUGOS INSTRUKCIJOS

- Būkite atsargūs, kai išimate prietaiso dureles. Durelės yra sunkios!
- Reguliariai valykite prietaisą, kad apsaugotumėte paviršių nuo nusidėvėjimo.
- Valykite prietaisą drėgna, minkšta šluoste. Naudokite tik neutralius ploviklius. Nenaudokite šveičiamųjų produktų, šveitimo kempinių, tirpiklių arba metalinių grandyklių.
- Jeigu naudojate orkaitės purškiklį, laikykitės ant pakuotės pateiktų saugumo nurodymų.

2.5 Pirolizinis valymas



ĮSPĖJIMAS!

Sužalojimo / gaisro / cheminių emisijų (dūmų) rizika naudojant pirolizės režimą.

- Prieš vykdydami pirolizinio išsivalymo funkciją arba prieš pirmą naudojimą, pašalinkite iš orkaitės:
 - bet kokius maisto likučius, aliejaus ar riebalų išsiliejimus / likučius;
 - išimamus daiktus (įskaitant lentynas, šoninius bėgelius ir pan., pateiktus su gaminiu), ypač nesvylančius puodus, keptuves, skardas, indus ir pan.;
- Atidžiai perskaitykite visus pirolizinio valymo nurodymus.
- Neprileiskite vaikų prie prietaiso, kol veikia pirolizinis valymas. Prietaisas labai įkaista ir karštas oras išeina iš priekinių aušinimo angų.
- Pirolizinis valymas yra aukštos temperatūros procesas, kurio metu iš maisto ruošimo likučių ir konstrukcinių medžiagų gali išsiskirti dūmai, todėl vartotojams primygtinai rekomenduojama:
 - pirolizinio valymo metu ir po jo pasirūpinti geru vėdinimu;
 - pirmą kartą naudojant prietaisą maksimalia temperatūra ir po to užtikrinti gerą vėdinimą.
- Kitaip nei žmonės, kurie paukščiai ir ropliai yra nepaprastai jautrūs garams, kylantiems visų pirolizinių orkaitių valymo proceso metu.
 - Patraukite visus naminius gyvūnus (ypač paukščius) toliau nuo prietaiso pirolizinio valymo metu ir po jo bei pirmą kartą paleidę prietaisą veikti didžiausia temperatūra į gerai vėdinamą plotą.
- Maži naminiai gyvūnai gali būti labai jautrūs lokalizuotiems temperatūros pokyčiams šalia visų pirolizinių orkaitių, kai veikia pirolizinė savaiminio išsivalymo programa.
- Visų pirolizinių orkaitių pirolizinio valymo metu aukšta temperatūra gali sugadinti nesvylančią puodų, keptuvių, skardų, virtuvės indų ir pan. dangą, o taip pat gali būti nedidelio lygio kenksmingų dūmų šaltiniu.
- Dūmai, kylantys iš visų pirolizinių orkaitių / nudeginant maisto gaminimo metu likusius nešvarumus, žmonėms, įskaitant vaikus ar sveikatos sutrikimų turintiems asmenims, nėra kenksmingi.

2.6 Vidinis apšvietimas



ĮSPĖJIMAS!

Pavojus gauti elektros smūgį.

- Šio gaminio viduje esanti (-čios) lemputė (-ės) ir atskirai parduodamos atsarginės lemputės: Šios lemputės turi atlaikyti ekstremalias fizines sąlygas buitiniuose prietaisuose, pavyzdžiui, temperatūrą, vibraciją, drėgmę, arba yra skirtos informuoti apie prietaiso veikimo būseną. Jos nėra skirtos naudoti kitoms paskirtims ir netinka patalpoms apšviesti.
- Naudokite tik tų pačių techninių duomenų lemputes.

2.7 Aptarnavimas

- Dėl prietaiso remonto kreipkitės į įgaliotąjį techninės priežiūros centrą.

- Naudokite tik originalias atsargines dalis.

2.8 Šalinimas



ĮSPĖJIMAS!

Pavojus susižeisti arba uždusti.

- Ištraukite maitinimo laido kištuką iš maitinimo tinklo lizdo.
- Nupjaukite maitinimo laidą arti prietaiso ir pašalinkite jį.
- Išimkite durų užraktą, kad vaikai arba naminiai gyvūnai neįstrigtų prietaise.

3. GAMINIO APRAŠYMAS

3.1 Bendroji apžvalga

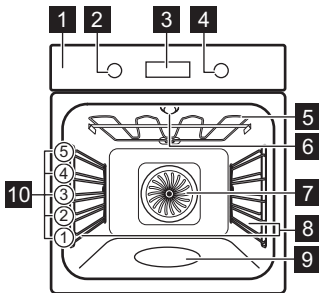

- 1** Valdymo skydelis
- 2** Kaitinimo funkcijų nustatymo rankenėlė
- 3** Valdymo skydelis
- 4** Valdymo rankenėlė
- 5** Šildymo elementas
- 6** Lemputė
- 7** Ventilatorius
- 8** Lentynos atrama, išimama
- 9** Vietos lentynoje
- 10** Orkaitės vidaus įduba

KAIP ĮJUNGTI IR IŠJUNGTI ORKAITĘ.

3.2 Priedai

Vielinė lentynėlė

Virtuvės reikmenims, pyragų formoms, prikaistuviams.

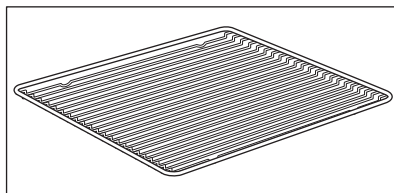

Kepimo padėklas

Pyragams ir sausainiams kepti.

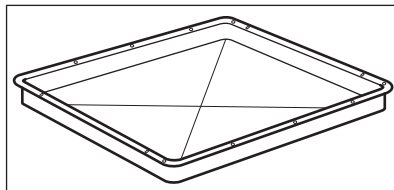

Grilio / kepinimo prikaistuvis

Kepti ir skrudinti arba riebalams surinkti.

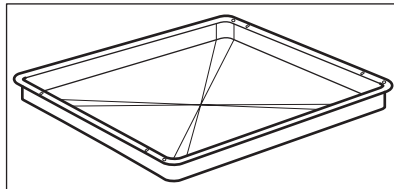

Teleskopiniai bėgeliai

Skardoms ir grotelėms lengviau įdėti ir išimti.

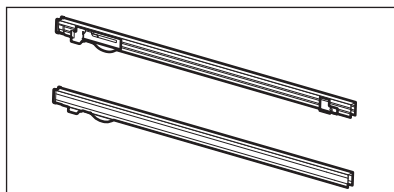









4. KAIP ĮJUNGTI IR IŠJUNGTI ORKAITĘ.







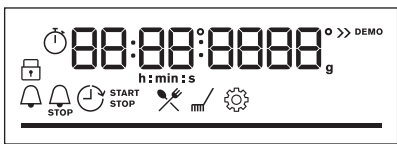

4.1 Įstumiamos rankenėlės

Norėdami naudoti prietaisą, paspauskite rankenėlę. Rankenėlė iššoka.

4.2 Valdymo skydelis

Valdymo skydelio jutikliai					Laikykite nuspaudę	Pasukite rankenėlę
 Laikmatis	 Greitas įkaitinimas	 Orkaitės apšvietimas	 Užraktas	OK		
Norėdami įjungti orkaitę, pasirinkite kaitinimo funkciją.						
Pasukite kaitinimo funkcijų rankenėlę į išjungimo padėtį, kad išjungtumėte orkaitę.						

	Kai pasuksite orkaitės kaitinimo funkcijų rankenėlę į išjungimo padėtį, valdymo skydelis išsijungia.
	Kepdami maistą valdymo skydelyje matysite pasirinktą temperatūrą, paros laiką ir kitas galimas parinktis.
	Valdymo skydelis su pasirinktu didžiausiu galimu funkcijų skaičiumi.

Valdymo skydelio indikatoriai				
 Užraktas	 Kepimo vadovas	 Valymas	 Nustatymai	 Greitas įkaitinimas
Laikmačio indikatoriai:				

PRIEŠ NAUDODAMI PIRMĄ KARTĄ

Progreso juosta – temperatūrai arba laikui.	
---	---

Kepimo garuose indikatorius	
-----------------------------	---





5. PRIEŠ NAUDODAMI PIRMĄ KARTĄ

 ĮSPĖJIMAS! Žr. saugos skyrius.

5.1 Pirminis valymas

Prieš naudodami pirmą kartą, išvalykite tuščią orkaitę ir nustatykite laiką:			
			 00:00 Nustatykite laiką. Paspauskite OK.

5.2 Pirminis pašildymas

	Prieš pirmąjį naudojimą įkaitinkite tuščią orkaitę.		
1-as veiksmas	Išimkite iš orkaitės visus priedus ir išimamas lentynų atramas.		
2-as veiksmas	Nustatykite maksimalią temperatūrą funkcijai:  Palikite orkaitę veikti 1 val.		
3-ias veiksmas	Nustatykite maksimalią temperatūrą funkcijai:  Palikite orkaitę veikti 15 min.		
 Iš orkaitės gali sklirti kvapas ir dūmai išankstinio įkaitinimo metu. Pasirūpinkite, kad patalpa būtų vėdinama.			

6. KASDIENIS NAUDOJIMAS



ĮSPĖJIMAS!

Žr. saugos skyrius.

6.1 Kaip nustatyti Kaitinimo funkcijas

Gaminimo pradžia	
1-as veiksmas	2-as veiksmas
Pasirinkite kaitinimo funkciją.	Nustatykite temperatūrą.

Maisto gaminimas garuose			
Patikrinkite, ar orkaitė atvėsusi.			
1-as veiksmas	2-as veiksmas	3-ias veiksmas	4-as veiksmas.
			Iš anksto pakaitinkite tuščią orkaitę 10 min., kad padidėtų drėgmė. Įdėkite maistą į orkaitę.
Pripildykite orkaitės vidaus įdubą vandeniu iš čiaupo.	Nustatykite kaitinimo garais funkciją.	Nustatykite temperatūrą.	
<p>i Maksimali įdubos talpa – 250 ml. Nepildykite orkaitės vidaus įdubos, kai gaminate maistą arba kai orkaitė yra įkaitusi.</p>			







Pasibaigus maisto ruošimo garuose ciklui:		
1-as veiksmas	2-as veiksmas	3-as veiksmas



Pasibaigus maisto ruošimo garuose ciklui:

pasukite kaitinimo funkcijų rankenėlę į išjungimo padėtį, kad išjungtumėte orkaitę.	Atsargiai atidarykite dureles. Išsiveržusi drėgmė gali sukelti nudegimus.	Patikrinkite, ar orkaitė atvėsusi. Pašalinkite likusį vandenį iš orkaitės vidaus įdubos.
---	---	--

6.2 Kaitinimo funkcijos

Standartinės kaitinimo funkcijos

Kaitinimo funkcija	Paskirtis
 Karšto oro srautas	Skirta vienu metu kepti ir maistui džiovinti trijuose lygiuose. Nustatykite 20–40 °C mažesnę temperatūrą nei Apatinis + viršutinis kaitinimas atveju.
 Apatinis + viršutinis kaitinimas	Kepti ir skrudinti maistą vienoje lentynos padėtyje.
 SteamBake	Drėgmei padidinti ruošiant maistą. Išgauti tinkamą spalvą ir traškią plutelę. Skirta pašildomiems patiekalams suteikti sultingumo. Vaisiams ar daržovėms konservuoti.
 Picos programa	Kepti picą. Intensyviai skrudinti ir traškiam pagrindui paruošti.
 Apatinis kaitinimas	Kepti pyragus traškiu pagrindu ir konservuoti maistą.
 Šaldytas maistas	Traškiems pusfabrikačiams ruošti (pvz., gruzdintoms bulvytėms, keptoms bulvytėms ar rytietiškiems suktinukams).
 Drėgnas konvek. kepimas	Ši funkcija ruošiant maistą padeda taupyti energiją. Naudojantis šia funkcija temperatūra orkaitėje gali skirtis nuo nustatytos. Išnaudojamas perteklinis karštis. Kaitinimo galią galima sumažinti. Daugiau informacijos rasite skyriuje „Kasdienis naudojimas“, Pastabos apie: Drėgnas konvek. kepimas.

Kaitinimo funkcija	Paskirtis
 Grilis	Ploniems maisto gabalėliams ir duonos skrebučiams kepti grilyje.
 Terminis kepintuvas	Skirta didesniems mėsos arba paukštienos su kaulais gabalams kepti viename lygyje. Tinka apkepams ir skrudinti.
 Menu	Skirta atverti meniu: Kepimo vadovas, Valymas, Nustatymai.

6.3 Pastabas matysite Drėgnas konvek. kepimas

Ši funkcija naudojama vertinant energijos sąnaudų efektyvumo klasę ir atitikimą ekologiniams reikalavimams, kaip numato ES 65/2014 ir ES 66/2014 direktyvos. Patikros pagal EN 60350-1 standartą.







Gaminant maistą orkaitės durelės turi būti uždarytos, kad funkcija nebūtų nutraukta ir veiktų efektyviausiai.

Naudojant šią funkciją, lemputė automatiškai išsijungs po 30 sekundžių.



Nurodymus dėl maisto gaminimo rasite skyriuje „Patarimai“, Drėgnas konvek. kepimas. Dėl energijos taupymo rekomendacijų žr. skyrių „Energijos efektyvumas“, „Energijos taupymas“.

6.4 Kaip nustatyti Kepimo vadovas





Kiekvienam patiekalui šiame papildomame meniu rekomenduojama funkcija ir temperatūra. Gamindami maistą galite keisti laiką ir temperatūrą.

Kepimo vadovas – naudokite greitai patiekalams ruošti taikant numatytuosius nustatymus:			
1-as veiksmas	2-as veiksmas	3-ias veiksmas	4-as veiksmas.
 	 	 1 - 45	 OK
Atverkite meniu.	Pasirinkite Kepimo vadovas. Paspauskite OK.	Pasirinkite patiekalą. Paspauskite OK.	[orkaitę įdėkite patiekalą. Patvirtinkite nustatymą.

6.5 Kepimo vadovas su receptais

Paaiškinimas	
	Vandens kiekis garų funkcijai.
	Prieš pradėdami gaminti maistą orkaitę įkaitinkite.
	Lentynėlės lygis.











Funkcijai pasibaigus patikrinkite, ar maistas tinkamai paruoštas.

	Patiekalas	Svoris	Lentynėlės padėtis / priedai	Trukmė
Jautiena 				
P1	Jautienos kepsnys, lengvai iškeptas			40 min.
P2	Jautienos kepsnys, vidutiniškai iškeptas	1–1,5 kg; 4–5 cm storio gabalai	 2; kepimo padėklas Mėsą kelias minutes pakepkite įkaitintoje keptuvėje. Įdėkite į orkaitę.	50 min.
P3	Jautienos kepsnys, gerai iškeptas			60 min.
P4	Kepsnys, vidutiniškai iškeptas	180–220 g vienas gabalas; 3 cm storio griežiniai	  3; patiekalo kepimas ant vielinės lentynėlės Mėsą kelias minutes pakepkite įkaitintoje keptuvėje. Įdėkite į orkaitę.	15 min.
P5	Jautienos kepsnys / troškiny (antrekotas, šlaunies kepsnys, storas paslėpsnis)	1,5–2 kg	 2; patiekalo kepimas ant vielinės lentynėlės Mėsą kelias minutes pakepkite įkaitintoje keptuvėje. Pridėti skysčio. Įdėkite į orkaitę.	120 min.























	Patiekalas	Svoris	Lentynėlės padėtis / priedai	Trukmė
P6	Jautienos kepsnys, lengvai iškeptas (kepimas žemoje temperatūroje)	1–1,5 kg; 4–5 cm storio gabalai	☒ 2; kepimo padėklas Naudokite savo mėgstamiausius prieskonius arba paprasčiausiai pasūdykite ir pabarstykite šviežiai maltais pipirais. Mėsą kelias minutes pakepkite įkaitintoje keptuvėje. Įdėkite į orkaitę.	75 min.
P7	Jautienos kepsnys, vidutiniškai iškeptas (kepimas žemoje temperatūroje)			85 min.
P8	Jautienos kepsnys, gerai iškeptas (kepimas žemoje temperatūroje)			130 min.
P9	Filė, lengvai iškepta (kepimas žemoje temperatūroje)	0,5–1,5 kg; 5–6 cm storio gabalai	☒ 2; kepimo padėklas Naudokite savo mėgstamiausius prieskonius arba paprasčiausiai pasūdykite ir pabarstykite šviežiai maltais pipirais. Mėsą kelias minutes pakepkite įkaitintoje keptuvėje. Įdėkite į orkaitę.	75 min.
P10	Filė, vidutiniškai iškepta (kepimas žemoje temperatūroje)			90 min.
P11	Filė, gerai iškepta (kepimas žemoje temperatūroje)			120 min.
Veršiena 🍖				
P12	Veršienos kepsnys (pvz., nugarinė)	0,8–1,5 kg; 4 cm storio gabalai	☒ 2; patiekalo kepimas ant vielinės lentynėlės Naudokite savo mėgstamiausius prieskonius. Pridėti skysčio. Uždengtas kepsnys.	80 min.

KASDIENIS NAUDOJIMAS

	Patiekalas	Svoris	Lentynėlės padėtis / priedai	Trukmė
Kiauliena 🍖 🍖				
P13	Kiaulienos sprandinės arba nugarinės kepsnys	1,5–2 kg	☒ 2 ; patiekalo kepimas ant vielinės lentynėlės Praėjus pusei maisto gaminimo trukmės, mėsą apverskite.	120 min.
P14	Plėšytos kiaulienos LTC	1,5–2 kg	☒ 2 ; kepimo padėklas Naudokite savo mėgstamiausius prieskonius. Praėjus pusei maisto gaminimo trukmės, mėsą apverskite, kad vienodai paskrustų.	215 min.
P15	Nugarinė, šviežia	1–1,5 kg; 5–6 cm storio gabalai	☒ 2 ; patiekalo kepimas ant vielinės lentynėlės Naudokite savo mėgstamiausius prieskonius.	55 min.
P16	Šonkauliukai	2–3 kg; naudokite šviežius ir 2–3 cm storio šonkaulius	☒ 3 ; gili keptuvė Įpilkite skysčio, kad padengtų patiekalo apačią. Praėjus pusei maisto gaminimo trukmės, mėsą apverskite.	90 min.
Ėriena 🍖				
P17	Ėrienos koja su kaulu	1,5–2 kg; 7–9 cm storio gabalai	☒ 2 ; patiekalo kepimas ant kepimo padėklo Pridėti skysčio. Praėjus pusei maisto gaminimo trukmės, mėsą apverskite.	130 min.
Paukštiena 🍖				
P18	Visas viščiukas	1–1,5 kg; šviežias	☒ 2 ; 🍷 200 ml; kepkite patiekalą kepimo padėkle Naudokite savo mėgstamiausius prieskonius. Praėjus pusei maisto gaminimo trukmės, paukštinę apverskite, kad vienodai paskrustų.	60 min.

	Patiekalas	Svoris	Lentynėlės padėtis / priedai	Trukmė
P19	Viščiukas, pusė	0,5–0,8 kg	 3 ; kepimo padėklas Naudokite savo mėgstamiausius prieskonius.	40 min.
P20	Viščiuko krūtinėlė	180–200 g vienas gabalas	  2; kepkite patiekalą ant vielinės lentynėlės Naudokite savo mėgstamiausius prieskonius. Mėsą kelias minutes pakepkite įkaitintoje keptuvėje.	25 min.
P21	Viščiukų šlaunelės, atvės.	-	 3; kepimo padėklas Jei viščiuko šlaunelės užmarinavote, pasirinkite žemesnę temperatūrą ir kepkite ilgiau.	30 min.
P22	Visa antiš	2–3 kg	 2; patiekalo kepimas ant vielinės lentynėlės Naudokite savo mėgstamiausius prieskonius. Įdėkite mėsą į kepimo indą. Praėjus pusei maisto gaminimo trukmės, antį apverskite.	100 min
P23	Visa žąsis	4–5 kg	 2; gili keptuvė Naudokite savo mėgstamiausius prieskonius. Įdėkite mėsą į gilų kepimo padėklą. Praėjus pusei maisto gaminimo trukmės, žąsį apverskite.	110 min.
Kita 				
P24	Mėsos vyniotinis	1 kg	 2; vielinė lentynėlė Naudokite savo mėgstamiausius prieskonius.	60 min.
 Žuvis				
P25	Žuvis, kepta ant grot.	0,5–1 kg viena žuvis	 2 ; kepimo padėklas Į žuvį įdėkite sviesto ir pagardinkite savo mėgstamiausiais prieskoniais ir žolelėmis.	30 min.





KASDIENIS NAUDOJIMAS

	Patiekalas	Svoris	Lentynėlės padėtis / priedai	Trukmė
P26	Žuvies filė	-	  3; kepkite patiekalą ant vielinės lentynėlės Naudokite savo mėgstamiausius prieskonius.	20 min.
Saldūs kepiniai / desertai   				
P27	Sūrio pyragas	-	 2;  28 cm užveržiama kepimo forma ant vielinės lentynėlės	90 min.
P28	Obuolių pyragas	-	 2;  100–150 ml; kepimo padėklas	60 min.
P29	Obuolių tortas	-	 2; pyrago forma ant vielinės lentynėlės	40 min.
P30	Obuolių pyragas	-	 2;  100–150 ml;  22 cm pyrago forma ant vielinės lentynėlės	60 min.
P31	Šokoladiniai sausainėliai	2 kg	 3; gili keptuvė	30 min.
P32	Šokoladiniai keksiukai	-	 2;  100–150 ml; keksiukų padėklas ant vielinės lentynėlės	30 min.
P33	Pyragas su priedais	-	 2; pyragas ant vielinės lentynėlės	50 min.
Daržovės / Garnyrai   				
P34	Keptos bulvės	1 kg	 2; kepimo padėklas Sudėkite neluptytas ir nepjaustytas bulves ant kepimo padėklo.	50 min.
P35	Bulvių skiltelės	1 kg	 3; kepimo padėkle su kepimo popieriumi Naudokite savo mėgstamiausius prieskonius. Supjaustykite bulves skiltelėmis.	35 min.

	Patiekalas	Svoris	Lentynėlės padėtis / priedai	Trukmė
P36	Ant grilio kepintos daržovės	1–1,5 kg	3; kepimo padėkle su kepimo popieriumi Naudokite savo mėgstamiausius prieskonius. Supjaustykite daržoves.	30 min.
P37	Šaldyti krocketai	0,5 kg	3; kepimo padėklas	25 min.
P38	Šaldytos bulvytės	0,75 kg	3; kepimo padėklas	25 min.
Gratinas, duona ir pica				
P39	Lazanija / makaronų užkepėlė	1–1,5 kg	2; kepkite patiekalą ant vielinės lentynėlės	45 min.
P40	Bulvių plokštainis	1–1,5 kg	1; kepkite patiekalą ant vielinės lentynėlės	50 min.
P41	Šviežia pica, plona	-	2; 100 ml; kepimo padėkle su kepimo popieriumi	15 min.
P42	Šviežia pica, stora	-	2; 100 ml; kepimo padėkle su kepimo popieriumi	25 min.
P43	Pyragas „Quiche“	-	2; kepimo skarda ant vielinės lentynėlės	45 min.
P44	Prancūziškasis batonas / čiabata / balta duona	0,8 kg	3; 150 ml; kepimo padėkle su kepimo popieriumi Baltai duonai kepti reikia daugiau laiko.	30 min.
P45	Viso grūdo / juoda duona su priedais	1 kg	2; 150 ml; kepimo padėkle su kepimo popieriumi / ant vielinės lentynėlės	45 min.







7. LAIKRODŽIO FUNKCIJOS

7.1 Laikrodžio funkcijos







Laikrodžio funkcija	Paskirtis
	Laikmatis. Laikui pasibaigus išgirsite signalą.
	Kepimo laikas. Laikmačio atskaitai pasibaigus išgirsite signalą ir kaitinimo funkcija išsijungs.
	Atidėtas paleidimas. Nustatyti įjungimo ir (arba) maisto gaminimo pabaigos laiką.
	Laikmatis. Daugiausiai 23 val. 59 min. Ši funkcija orkaitės veikimui įtakos neturi. Jei norite įjungti ir išjungti Laikmatis, pasirinkite: Meniu, Nustatymai.

7.2 Kaip nustatyti Laikrodžio funkcijos

Kaip nustatyti: Paros laikas		
1-as veiksmas	2-as veiksmas	3-as veiksmas
		
Jei norite pakeisti paros laiką, atsidarykite meniu ir pasirinkite: „Nustatymai“, „Paros laikas“.	Nustatykite laikrodį.	Paspauskite OK.









Kaip nustatyti: Laikmatis			
1-as veiksmas		2-as veiksmas	3-as veiksmas
	Valdymo skydelyje matysite: 0:00 		
Paspauskite: 		Nustatykite Laikmatis	Paspauskite OK.
 Laikmatis iškart paleistas atskaitai.			

Kaip nustatyti: Kepimo laikas

1-as veiksmas	2-as veiksmas		3-as veiksmas	4-as veiksmas.
		Valdymo skydelyje matysite: 0:00 		
Pasirinkite kaitinimo funkciją ir temperatūrą.	Spauskite pakartotinai:  .		Nustatykite maisto gaminimo laiką.	Paspauskite OK.

 Laikmatis iškart paleistas atskaitai.

Kaip nustatyti: Atidėtas paleidimas

1-as veiksmas	2-as veiksmas		3-as veiksmas	4-as veiksmas.		5-as veiksmas.	6-as veiksmas
		Valdymo skydelyje matysite naujai nustatytą paros laiką  PRA- DĖTI			Valdymo skydelyje matysite: --:--  SU- STAB- DYTI		
Pasirinkite kaitinimo funkciją.	Spauskite pakartotinai:  .		Nustatykite paleidimo laiką.	Paspauskite OK.		Nustatykite pabaigos laiką.	Paspauskite OK.

 Laikmatis paleidžiamas atskaitai nustatytu paleidimo laiku.

8. KAIP NAUDOTI: PRIEDAI

8.1 Priedų įstatymas

Mažas įlenkimas viršuje padidina saugumą. Šie įlenkimai taip pat apsaugos nuo apvirtimo. Aukštas kraštas aplink lentynas neleidžia prikaistuviams nuslysti nuo lentynos.

PAPILDOMOS FUNKCIJOS

Vielinė lentynėlė:

Įstumkite groteles tarp lentynos atramos kreipiamųjų laikiklių.

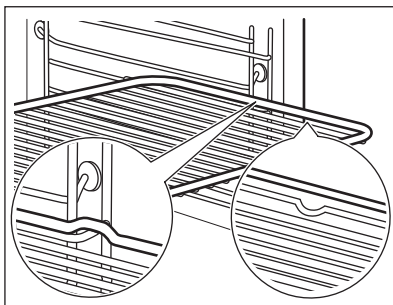

Kepimo padėklas /Gilus prikaistuvis:

Įstumkite skardą tarp lentynos atramos kreipiamųjų laikiklių.

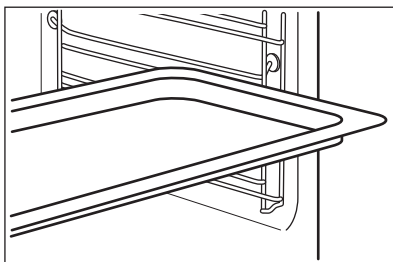

Vielinė lentynėlė, Kepimo padėklas /Gilus prikaistuvis:

Įstumkite skardą tarp lentynos atramos ir grotelių kreipiamųjų laikiklių.

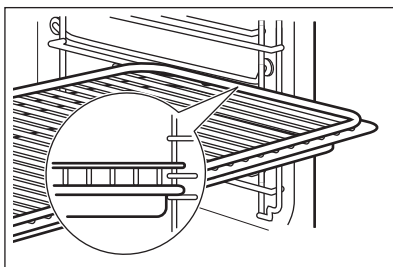

9. PAPILDOMOS FUNKCIJOS

9.1 Užraktas

Ši funkcija apsaugo nuo atsitiktinio orkaitės funkcijos pakeitimo.



Įjunkite orkaitę veikiant – nustatyta gamtinimo funkcija toliau veiks, valdymo skydelis užsirakins.
Įjunkite, kai orkaitė išjungta – orkaitė neįsijungs, valdymo skydelis užsirakins.

Ši funkcija apsaugo nuo atsitiktinio orkaitės funkcijos pakeitimo.





Paspauskite , kad įjungtumėte funkciją.
Suveiks garsinis signalas.

 – paspauskite ir palaikykite, kad išjungtumėte.

 3 x  – mirksės, kai užraktas bus įjungtas.

9.2 Automatinis išsijungimas

Siekiant užtikrinti saugumą po tam tikro laiko orkaitė išsijungs savaime, jei kaitinimo funkcija veiks, o nustatymų nepakeisite.

 (°C)	 (val.)
30 - 115	12.5
120 - 195	8.5
200 - 245	5.5
iki 250	3

Automatinis išsijungimas neveiks, jei naudosite šias funkcijas: Orkaitės apšvietimas, Atidėtas paleidimas.



9.3 Aušinimo ventiliatorius



Kai orkaitė veikia, aušinimo ventiliatorius įsijungia automatiškai, kad orkaitės paviršiai išliktų vėsūs. Orkaitę išjungus, aušinimo ventiliatorius gali veikti toliau, kol orkaitė atvėsta.

10. PATARIMAI

10.1 Drėgnas konvek. kepimas



Laikykitės toliau lentelėje nurodytų rekomendacijų, kad gautumėte geriausius rezultatus. Naudokite trečią lentynos padėtį.

	 (°C)	 (min.)
Makaronų plokštainis	200–220	45–55

	 (°C)	 (min.)
Bulvių plokštainis	180–200	70–85
Musaka	170–190	70–95
Lazanija	180–200	75–90
[daryti makaronai kaneloni	180–200	70–85
Duonos pudingas	190–200	55–70
Ryžių pudingas	170–190	45–60
Biskvitinės tešlos obuolių pyragas (apvali kepi- mo forma)	160–170	70–80
Balta duona	190–200	55–70

10.2 Drėgnas konvek. kepimas – rekomenduojami priedai

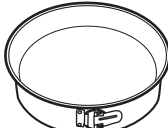
Naudokite tamsias ir neatspindinčias skardas ir indus. Jie geriau sugeria karštį, nei šviesių spalvų ir atspindintys indai.

			
Picos kepiamo indas	Kepimo indas	Keraminiai in- deliai	Apkepo skarda
Tamsi, neatspindinti 28 cm skersmens	Tamsi, neatspindinti 26 cm skersmens	Keraminė kait- lentė 8 cm skers- mens, 5 cm aukščio	Tamsi, neatspindinti 28 cm skersmens





10.3 Maisto gaminimo lentelės patikros įstaigoms

Informacija patikros įstaigoms

Patikros pagal: EN 60350, IEC 60350.



KEPIMAS VIENAME LYGYJE. Kepimas skardose





		 (°C)	 (min.)	
Biskvitinis pyragas be riebalų	Karšto oro srautas	140–150	35–50	2
Biskvitinis pyragas be riebalų	Apatinis + viršutinis kaitinimas	160	35–50	2
Obuolių pyragas, 2 kepi- mo formos Ø20 cm	Karšto oro srautas	160	60–90	2
Obuolių pyragas, 2 kepi- mo formos Ø20 cm	Apatinis + viršutinis kaitinimas	180	70–90	1









KEPIMAS VIENAME LYGYJE. Sausainiai









Naudokite trečią lentynos padėtį.

		 (°C)	 (min.)
Trapios tešlos kepiniai / smėlio juostelės	Karšto oro srautas	140	25–40
Trapios tešlos kepiniai / smėlio juostelės, įkaitinkite tuščią orkaitę	Apatinis + viršutinis kaiti- nimas	160	20–30
Pyragaičiai, 20 vienetų pa- dėkle, įkaitinkite tuščią or- kaitę	Karšto oro srautas	150	20–35
Pyragaičiai, 20 vienetų pa- dėkle, įkaitinkite tuščią or- kaitę	Apatinis + viršutinis kaiti- nimas	170	20–30

VALYMAS IR PRIEŽIŪRA



 KEPIMAS KELIAIS LYGIAIS. Sausainiai				
		 (°C)	 (min.)	
Trapios tešlos kepiniai / smėlio juostelės	Karšto oro srautas	140	25–45	1 / 4
Pyragaičiai, 20 vienetų padėkle, įkaitinkite tuščią orkaitę	Karšto oro srautas	150	23–40	1 / 4
Biskvitinis pyragas be riebalų	Karšto oro srautas	160	35–50	1 / 4

 GRILIS				
 Kaitinkite tuščią orkaitę 5 minutes.				
 Grilis nustačius didžiausią temperatūrą.				
		 (min.)		
Skrebutis	Grilis	1–3	5	
Jautienos kepsnys, laikui įpusėjus apverskite	Grilis	24–30	4	

11. VALYMAS IR PRIEŽIŪRA

 ĮSPĖJIMAS! Žr. saugos skyrius.

11.1 Pastabos dėl valymo

 <p>Valymo priemonės</p>	Orkaitės priekį valykite minkšta šluoste ir šiltu vandeniu su švelniu plovikliu.
	Metalinius paviršius valykite valymo tirpalu.
	Dėmes valykite švelniu plovikliu.
 <p>Kasdienis naudojimas</p>	Ertmę valykite po kiekvieno naudojimo. Riebalų kaupimasis ar kiti likučiai gali sukelti gaisrą.
	Nelaikykite patiekalų orkaitėje ilgiau nei 20 minučių. Po kiekvieno naudojimo iššluostykite ertmę minkšta šluoste.
 <p>Priedai</p>	Visus priedus valykite po kiekvieno naudojimo ir palikite juos išdžiūti. Valykite minkšta šluoste ir šiltu vandeniu bei švelniu plovikliu. Priedų indaplovėje plauti negalima.
	Priedams su nesvylančia danga valyti nenaudokite šveičiamojo valiklio ar aštrių daiktų.

11.2 Kaip valyti įduba vandeniu

Po maisto ruošimo garais išvalykite orkaitės vidaus įdubą, kad pašalintumėte kalkių likučius.

1-as veiksmas	2-as veiksmas	3-as veiksmas
Į įdubą įpilkite 250 ml baltojo acto. Naudokite ne stipresnį nei 6 % actą be priedų.	Palaukite 30 min., kol actas ištirpdyt likusias kalkių nuosėdas įprastos temperatūros aplinkoje.	Išvalykite įdubą šiltu vandeniu sudrėkinta minkšta šluoste.
Naudojant funkciją SteamBake, valykite orkaitę kas 5–10 maisto gaminimo ciklą.		

11.3 Kaip pašalinti: Lentynų atramos

Išimkite lentynų atramas ir išvalykite orkaitę.

VALYMAS IR PRIEŽIŪRA

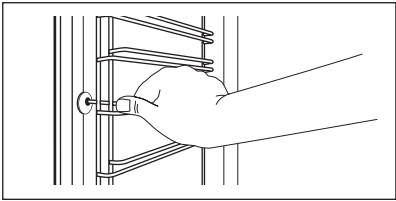
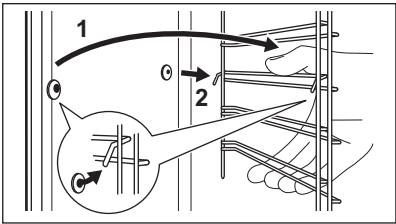
1-as veiksmas	Išjunkite orkaitę ir palaukite, kol atvės.	
2-as veiksmas	Atitraukite lentynos atramos priekį nuo šoninės sienelės.	
3-ias veiksmas	Lentynos atramos galinę dalį patraukite nuo šoninės sienelės ir ją ištraukite.	
4-as veiksmas	Įdėkite lentynos atramas atvirkščia tvarka. Ištraukiamų bėgelių atraminiai kaiščiai turi būti atsukti į priekį.	

11.4 Kaip naudoti: Pirolizinis valymas

Išvalykite orkaitę naudodamiesi Pirolizinis valymas funkcija.



ĮSPĖJIMAS!

Atsargiai, galite nusideginti.



DĖMESIO



Jeigu toje pačioje spintelėje įrengti kiti prietaisai, nenaudokite jų kol nesibaigs šios funkcijos programa. Atsargiai, galite sugadinti orkaitę.

Prieš Pirolizinis valymas:

Išjunkite orkaitę ir palaukite, kol atvės.	Išimkite visus priedus ir išimkite lentynų atramas.	Išvalykite orkaitės dugną ir vidinį durelių stiklą minkšta šluoste ir šiltu švelniu plovikliu skiestu vandeniui.
--	---	--

Pirolizinis valymas

1-as veiksmas	Atidarykite meniu: Valymas $m /$.	
Parinktis	Trukmė	
C1 - Lengvas valymas	1 h	
C2 - Įprastas valymas	1 h 30 min	

Pirrolizinis valymas	
C3 - Intensyvus valymas	3 h
2-as veiksmas	OK – paspauskite valymo programai pasirinkti.
3-as veiksmas	OK – paspauskite valymui pradėti.
4-as veiksmas.	Pasibaigus valymo programai, nustatykite kaitinimo funkcijų valdymo rankenėlę į išjungimo padėtį.
 Valymo režimo metu orkaitės lemputė neveiks.	
Orkaitės temperatūrai pakilus iki nustatytos reikšmės, durelės užsirakins. Iki durelės atsirakins, ekrane matysite:  .	

Valymo programai pasibaigus:		
Išjunkite orkaitę ir palaukite, kol atvės.	Išvalykite vidines sienelės švelnia šluoste.	Pašalinkite nuo orkaitės dugno visus nešvarumų likučius.

11.5 Priminimas apie valymą

Orkaitė primena, kada reikia valyti orkaitę, naudojant pirrolizinį valymą.	
 mirksi valdymo skydelyje 5 sek. po kiekvieno kepimo.	Jei norite išjungti priminimą, atverkite Meniu ir pasirinkite Nustatymai, Priminimas apie valymą.

11.6 Kaip išimti ir įdėti: Durelės

Dureles ir vidines stiklo plokštes galite išimti ir išvalyti. Skirtinguose modeliuose stiklo plokščių skaičius gali skirtis.

 ĮSPĖJIMAS! Durelės yra sunkios.
--

 DĖMESIO Stiklo plokštes valykite atsargiai, ypač prie priekinės plokštės briaunų. Galite įskelti arba sudaužyti stiklą.
--

VALYMAS IR PRIEŽIŪRA

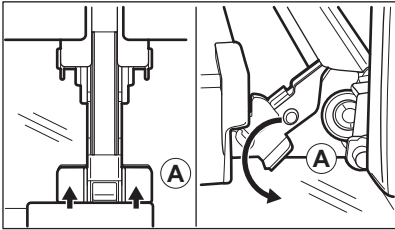
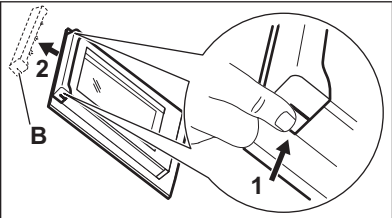
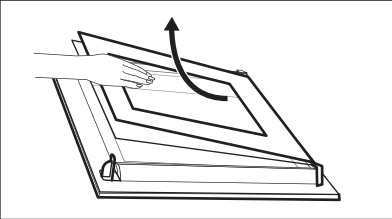
1-as veiksmas	Iki galo atidarykite dureles.	
2-as veiksmas	Pakelkite ir prispauskite suveržiamąsias svirtis (A) prie abiejų durelių vyrių.	
3-as veiksmas	Priverkite orkaitės dureles iki pirmos padėties (maždaug 70° kampu). Laikykite suėmę dureles už abiejų kraštų ir traukite jas į viršų ir tolyn nuo orkaitės. Padėkite dureles išorine puse ant minkšto audinio, pakloto ant lygaus ir tvirto pagrindo.	
4-as veiksmas	Laikydami durelių apdailą (B) abiejuose kraštuose paspauskite ją į vidų, kad atsilaisvintų tarpinė.	
5-as veiksmas	Patraukite durelių apdailą į save, kad nuimtumėte.	
6-as veiksmas	Po vieną suimkite durelių stiklo plokštes už viršutinės briaunos ir ištraukite iš šoninių kreiptuvų.	
7-as veiksmas	Stiklo plokštes plaukite vandeniu ir muilu. Atsargiai nusausinkite stiklo plokštes. Neplaukite stiklo plokščių indaplovėje.	
8-as veiksmas	Išvalę pasiruoškite sudėti plokštes atgal ta pačia tvarka.	
9-as veiksmas	Pirmiausia įdėkite mažesnę plokštę, po to didesnę ir dureles. Patikrinkite, ar tinkamai įdėjote plokštes, kitaip durelių paviršius gali perkaisti.	

11.7 Kaip pakeisti: Lemputė



ĮSPĖJIMAS!

Pavojus gauti elektros smūgį.
Lemputė gali būti karšta.

Prieš keisdami lemputę:

1-as veiksmas	2-as veiksmas	3-ias veiksmas
Išjunkite orkaitę. Palaukite, kol orkaitė atvės.	Atjunkite orkaitę nuo maitinimo tinklo.	Ertmės apačioje patieskite skudurėlį.

Viršutinė lemputė

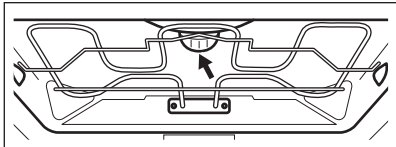
1-as veiksmas	Pasukite stiklinį gaubtelį ir nuimkite jį.	
2-as veiksmas	Nuvalykite stiklinį gaubtelį.	
3-ias veiksmas	Lemputę pakeiskite tinkama, 300 °C karščiui atsparia lempute.	
4-as veiksmas	Uždėkite stiklinį gaubtelį.	

12. TRIKČIŲ ŠALINIMAS



ĮSPĖJIMAS!

Žr. saugos skyrius.

12.1 Ką daryti, jeigu...

Šioje lentelėje nenumatytais atvejais kreipkitės į įgaliotąjį aptarnavimo centrą.



Orkaitė neįsijungia arba nekaista

Triktis	Patikrinkite, ar...
Orkaitės nepavyksta įjungti arba valdyti.	Orkaitė tinkamai prijungta prie elektros maitinimo.

TRIKČIŲ ŠALINIMAS



Orkaitė neįsijungia arba nekaista

Orkaitė neįkaista.	Išjungta automatinio išsijungimo funkcija.
Orkaitė neįkaista.	Orkaitės durelės uždarytos.
Orkaitė neįkaista.	Perdegė saugiklis.
Orkaitė neįkaista.	Išjungtas vaikų saugos užraktas.



Komponentai

Triktis	Patikrinkite, ar...
Lemputė išjungta.	Drėgnas konvek. kepimas – įjungta.
Lemputė neveikia.	Perdegė lemputė.



Klaidų kodai

Ekrane rodomas...	Patikrinkite, ar...
Err C3	Orkaitės durelės uždarytos ir nesulaužytas durelių užraktas.
Err F102	Orkaitės durelės uždarytos.
Err F102	Durelių užraktas nesugadintas.
00:00	Buvo dingęs elektros maitinimas. Nustatykite paros laiką.

Jeigu valdymo skydelyje rodomas klaidos kodas, kurio nėra šioje lentelėje, išjunkite ir vėl įjunkite namų saugiklį, kad vėl įjungtumėte orkaitę. Jeigu klaidos kodas kartojasi, kreipkitės į įgaliotąjį aptarnavimo centrą.



Valymas

Triktis	Patikrinkite, ar...
Iš vidinės įdubos išteka vanduo.	Vidinėje įduboje per daug vandens.

12.2 Aptarnavimo duomenys

Jeigu patys negalite rasti problemos sprendimo, kreipkitės į prekybos atstovą arba įgaliotąjį techninės priežiūros centrą.

Duomenys, kuriuos būtina pateikti techninės priežiūros centrui, nurodyti techninių duomenų lentelėje. Duomenų lentelę rasite orkaitėje, ant priekinio rėmo. Nenuimkite duomenų lentelės nuo orkaitės vidaus.

Rekomenduojame duomenis užsirašyti čia:	
Modelis (MOD.)
Gaminio numeris (PNC)
Serijos numeris (S. N.)

13. ENERGIJOS EFEKTYVUMAS

13.1 Informacija apie gaminį ir informacijos apie gaminį lapas*

Tiekėjo pavadinimas	AEG
Modelio žymuo	BPB351160M 944188506 BPS351160M 944188507
Energijos efektyvumo indeksas	81,2
Energijos vartojimo efektyvumo klasė	A+
Energijos sąnaudos esant įprastai apkrovai, veikiant įprastu režimu	1,09 kWh/ciklui
Energijos sąnaudos esant įprastai apkrovai, veikiant ventiliatoriaus režimu	0,69 kWh/ciklui
Ertmių skaičius	1

MENIU STRUKTŪRA

Karščio šaltinis	Elektra	
Tūris	71 l	
Orkaitės rūšis	Integruojama orkaitė	
Masė	BPB351160M	34.0 kg
	BPS351160M	34.0 kg

* Europos Sąjungai pagal ES reglamentus 65/2014 ir 66/2014.
Baltarusijos Respublikai pagal STB 2478-2017, G priedą; STB 2477-2017, A ir B priedus.
Ukrainai pagal 568/32020.

Energijos vartojimo efektyvumo klasė netaikytina Rusijai.

EN 60350-1. Būtiniai elektriniai virimo ir kepimo prietaisai. 1 dalis. Viryklės, orkaitės, garinės orkaitės ir kepintuvai. Eksploatacinių charakteristikų matavimo metodai.

13.2 Energijos taupymas



Orkaitėje yra funkcijų, kurios kiekvieną dieną ruošiant maistą padės taupyti energiją.

Patikrinkite, ar orkaitei veikiant durelės yra tinkamai uždarytos. Gamindami maistą orkaitės durelių be reikalo neatidarinėkite. Durelių sandariklis privalo būti švarus ir tinkamai užfiksuotas. Naudokite metalinius prikaistuvius, taip taipiau naudosite energiją.

Jei įmanoma, prieš gamindami orkaitės iš anksto nekaitinkite.

Jei vienu metu ruošiate kelis patiekalus, tarp kepimų darykite kuo trumpesnes pertraukas.

Maisto gaminimas naudojant ventiliatorių

Jei įmanoma, gamindama maistą naudokite ventiliatorių, taip taupysite energiją.

Liekamasis karštis

Ventiliatorius ir apšvietimas veiks toliau. Jei išjungsite orkaitę, valdymo skydelyje matysite likusiojo karščio reikšmę. Likusį karštį galite naudoti, kad maistas neatvėstų.

Jei maisto gaminimo trukmė ilgesnė nei 30 min., likus 3–10 min. iki gaminimo pabaigos sumažinkite orkaitės temperatūrą iki minimumo. Dėl likusiojo orkaitės karščio maisto gaminimo procesas toliau tęsis.

Naudokite likusį karštį kitiems patiekalams pašildyti.

Patiekalų laikymas šilumoje

Pasirinkite žemiausios temperatūros nustatymą ir panaudokite likusį karštį patiekalų šilumai palaikyti. Valdymo skydelyje matysite likusiojo karščio indikatorių arba temperatūrą.

Maisto gaminimas išjungus apšvietimą

Gamindami maistą apšvietimą išjunkite. Įjunkite jį tik tuomet, kai to reikės.



Drėgnas konvek. kepimas



Funkcija skirta taupyti energiją gaminant maistą.



Jei naudosite šią funkciją, lemputė automatiškai išsijungs po 30 sek. Galite vėl įjungti lemputę, tačiau taip sunaudosite daugiau energijos.

14. MENIU STRUKTŪRA

14.1 Meniu

	 – pasirinkite, kad atvertumėte Meniu.
---	---



Meniu struktūra		
Kepimo vadovas 	Valymas 	Nustatymai 

1-as veiksmas	2-as veiksmas	3-ias veiksmas	4-as veiksmas	5-as veiksmas.
 	 OK	 O1–O11	 OK	
Pasirinkite Meniu, Nustatymai.	Patvirtinkite nustatymą.	Pasirinkite nustatymą.	Patvirtinkite nustatymą.	Pasirinkite reikšmę ir paspauskite OK.

Nustatymai					
O1	Paros laikas	Pakeisti	O2	Ekrano ryškumas	1 - 5
O3	Mygtukų tonai	1 – Pypsėjimas 2 – spragtelėjimas 3 – garsas išjungtas	O4	Ispėjamo signalo garsas	1 - 4
O5	Laikmatis	Ijungta / išjungta	O6	Orkaitės apšvietimas	Ijungta / išjungta
O7	Greitas įkaitinimas	Ijungta / išjungta	O8	Priminimas apie valymą	Ijungta / išjungta
O9	Demonstracinis režimas	Aktyvavimo kodas: 2468	O10	Programinės įrangos versija	Tikrinti

Nustatymai		
O11	Atkurti visus nustatymus	Taip / ne

15. APLINKOS APSAUGA

Atiduokite perdirbti medžiagas, pažymėtas šiuo ženklu . Išmeskite pakuotę į atitinkamą atliekų surinkimo konteinerį, kad ji būtų perdirbta. Padėkite saugoti aplinką bei žmonių sveikatą ir surinkti bei perdirbti elektros ir elektronikos prietaisų atliekas. Neišmeskite šiuo ženklu  pažymėtų prietaisų kartu su kitomis buitinėmis atliekomis. Atiduokite šį gaminį į vietos atliekų surinkimo punktą arba susisiekite su vietos savivaldybe dėl papildomos informacijos.

ЗА СОВРШЕНИ РЕЗУЛТАТИ

Ви благодариме што го избравте овој AEG производ. Го создадовме за да ви обезбедиме долгогодишна беспрекорна работа, со иновативни технологии кои го прават животот поедноставен - функции што можеби нема да ги најдете кај обичните апарати. Ве молиме одвојте неколку минути за читање за да го добиете најдоброто од овој апарат. Посетете ја нашата страница за да:



Добиете совети за користење, брошури, водич за решавање проблеми, информации за сервисирање и поправка:

www.aeg.com/support



Регистрирајте го вашиот производ за подобро сервисирање:

www.registreaeg.com



Купувајте дополнителен прибор, потрошни материјали или оригинални резервни делови за вашиот апарат:

www.aeg.com/shop



За повеќе рецепти, совети, решавање проблеми, преземете ја апликацијата **My AEG Kitchen**.





ГРИЖА ЗА КОРИСНИЦИ И СЕРВИСИРАЊЕ

Ви препорачуваме да користите оригинални резервни делови.

Кога ќе контактирате со нашиот овластен сервисен центар, погрижете се да ги имате на располагање следниве податоци: Модел, Број на производот, Сериски број.

Информациите можат да се најдат на етикетата со информации.

 Предупредување / Внимание-Безбедносни информации

 Општи информации и совети

 Информации за животната средина

Можноста за промени е задржана.

СОДРЖИНА

1. БЕЗБЕДНОСНИ ИНФОРМАЦИИ.....	330	2.7 Сервисирање.....	336
1.1 Сигурност за деца и ранлива категорија на лица.....	330	2.8 Расходување.....	336
1.2 Општа безбедност.....	331	3. ОПИС НА ПРОИЗВОДОТ.....	336
2. БЕЗБЕДНОСНИ УПАТСТВА.....	332	3.1 Општ преглед.....	337
2.1 Монтажа.....	332	3.2 Accessories.....	337
2.2 Поврзување на струјата.....	333	4. КАКО ДА СЕ ВКЛУЧИ И ИСКЛУЧИ ПЕЧКАТА.....	338
2.3 Употреба.....	334	4.1 Тркалца коишто се повлекуваат.....	338
2.4 Нега и чистење.....	335	4.2 Контролна табла.....	338
2.5 Чистење со пиролиза.....	335		
2.6 Внатрешна светилка.....	336		

5. ПРЕД ПРВАТА УПОТРЕБА.....	339	10.2 Печете со влажен воздух - препорачани додатоци.....	354
5.1 Првично чистење.....	339	10.3 Табели за готвење за институти за тестирање.....	354
5.2 Прво предзагревање.....	340	11. НЕГА И ЧИСТЕЊЕ.....	356
6. СЕКОЈДНЕВНА УПОТРЕБА.....	340	11.1 Забелешки за чистењето.....	357
6.1 Како да поставите: Функции на греење.....	340	11.2 Начин на чистење: Втиснување во шуплината.....	357
6.2 Функции за греење.....	341	11.3 Како да отстранете: Држачи на решетки	357
6.3 Забелешки за: Печете со влажен воздух.....	342	11.4 Начин на користење: Чистење со пиролиза.....	358
6.4 Како да поставите: Готвење со помош.....	343	11.5 Потсетник за чистење.....	359
6.5 Готвење со помош со рецепти..	343	11.6 Како да извадите и да монтирате: Врата.....	359
7. ФУНКЦИИ НА ЧАСОВНИКОТ.....	349	11.7 Како да замените: Светло.....	361
7.1 Функции на часовник.....	349	12. РЕШАВАЊЕ НА ПРОБЛЕМИ.....	361
7.2 Како да поставите: Функции на часовник.....	350	12.1 Што да се направи ако.....	361
8. НАЧИН НА КОРИСТЕЊЕ: ДОДАТОЦИ.....	351	12.2 Податоци за сервис.....	363
8.1 Вметнување на додатоци.....	351	13. ЕНЕРГЕТСКА ЕФИКАСНОСТ.....	363
9. ДОПОЛНИТЕЛНИ ФУНКЦИИ.....	352	13.1 Информации за производот и Страница за информации за производот*.....	363
9.1 Заклучување.....	352	13.2 Заштеда на енергија.....	364
9.2 Автоматско исклучување.....	352	14. СТРУКТУРА НА МЕНИ.....	365
9.3 Вентилатор за ладење.....	353	14.1 Мени.....	365
10. ПОМОШ И СОВЕТИ.....	353		
10.1 Печете со влажен воздух.....	353		

1. БЕЗБЕДНОСНИ ИНФОРМАЦИИ

Пред монтирање и користење на апаратот, ве молиме внимателно да ги прочитате приложените упатства. Производителот не сноси одговорност за направена повреда или штета кои се резултат на неправилна монтажа или употреба. Секогаш чувајте ги упатствата на сигурно и безбедно место за подоцнежна употреба.

1.1 Сигурност за деца и ранлива категорија на лица

- Овој апарат може да го користат деца над 8 години и лица со намалени физички, сетилни или ментални

способности или лица без искуство и знаење доколку тоа го прават под надзор или доколку им биле дадени упатства како безбедно да го употребуваат апаратот, и доколку ги разбираат опасностите поврзани со него. Не смее да биде на дофат на деца помали од 8 години и лица со многу обемни и сложени пречки во развојот, освен ако не се под постојан надзор.

- Децата треба да бидат под надзор да не играат со апаратот.
- Држете ја амбалажата подалеку од деца и фрлете ја соодветно.
- **ПРЕДУПРЕДУВАЊЕ:** Држете ги децата и милениците подалеку од апаратот кога работи или кога се лади. Достапните делови може да станат жешки за време на употребата.
- Ако апаратот има уред за заштита на деца, треба да се вклучи.
- Децата не треба да го чистат или да го оддржуваат апаратот без надзор.

1.2 Општа безбедност

- Само квалификувано лице може да го монтира уредот и да го замени кабелот.
- Не користете го апаратот пред да го монтирате во вградената структура.
- Пред одржување, исклучете го апаратот од напојувањето.
- Доколку се оштети кабелот за напојување, тој треба да биде заменет од страна на производителот, негов Овластен сервисен центар или слично квалификувани лица за да се избегне опасност.
- **ПРЕДУПРЕДУВАЊЕ:** Пред да ја менувате сијалицата во печката, уверете се дека уредот е исклучен, за да ја избегнете можноста од струен удар.

БЕЗБЕДНОСНИ УПАТСТВА

- **ПРЕДУПРЕДУВАЊЕ:** Апаратот и неговите достапни делови се вжештуваат за време на употребата. Треба да се внимава да не се допираат грејачите.
- Секогаш користете ракавици за рерна за вадење или ставање прибор или огноотпорни садови.
- За да ги извадите држачите на решетките, повлечете го предниот дел од држачот на решетката, а потоа задниот крај настрана од страничните сидови. Монтирајте ги држачите на решетките по обратен редослед.
- Не користете чистач на пареа за чистење на апаратот.
- Не користете груби абразивни средства или остри метални стругалки за да го чистите стаклото на вратата, бидејќи тоа може да предизвика прскање на стаклото.
- Претечената храна мора да се отстрани пред чистење со пиролиза. Извадете ги сите делови од рерната.

2. БЕЗБЕДНОСНИ УПАТСТВА

2.1 Монтажа



ПРЕДУПРЕДУВАЊЕ!

Апаратот мора да го монтира само квалификувано лице.

- Извадете ја целата амбалажа.
- Немојте да монтирате ниту да користите оштетен апарат.
- Следете ги инструкциите за монтирање дадени со апаратот.
- Секогаш внимавјте кога го пренесувате апаратот затоа што е тежок. Секогаш носете заштитни ракавици и приложените обувки.
- Не влечете го апаратот за рачката.
- Монтирајте го апаратот во сигурно и погодно место кое ги исполнува потребите за монтажа.
- Одржувајте минимална оддалеченост од другите апарати и делови.
- Преда да го монтирате апаратот, проверете дали вратата на рерната се отвара со леснотија.
- Апаратот е опремен со систем за електрично ладење. Мора да се ракува со напојување.
- Вградената единица мора да ги исполнува условите за стабилност на DIN 68930.

Минимална висина на плакар (Минимална висина на плакар под површината за готвење)	578 (600) mm
Должина на плакар	560 mm

Длабочина на плакар	550 (550) mm
Висина на предниот дел од апаратот	594 mm
Висина на задниот дел од апаратот	576 mm
Широчина на предниот дел од апаратот	595 mm
Широчина на задниот дел од апаратот	559 mm
Длабочина на апаратот	567 mm
Вградена длабочина на апаратот	546 mm
Длабочина со отворена врата	1027 mm
Минимална големина на отворот за вентилација. Отвор ставен на дното на задната страна	560 x 20 mm
Должина на кабелот за струја. Кабелот е ставен во десниот агол од задната страна	1500 mm
Завртки за монтирање	4 x 25 mm

2.2 Поврзување на струјата



ПРЕДУПРЕДУВАЊЕ!

Ризик од пожар и струен удар.

- Секое поврзување со струја треба да биде направено од квалификуван електричар.
- Апаратот мора да биде заземјен.
- Проверете дали параметрите на плочката со спецификации се компатибилни со електричната моќност на мрежата на електрична енергија.
- Секогаш користете правилно монтиран штекер отпорен на струјни удари.
- Не користете адаптери со повеќе приклучоци и продолжни кабли.
- Погрижете се да не ги оштетите приклучокот за струја и кабелот. Доколку кабелот за струја на апаратот треба да се замени, тоа мора да го направи нашиот Овластен сервисен центар.
- Не дозволувајте кабелот да дојде во допир со или да биде близу до вратата на апаратот, особено кога работи или кога вратата е жешка.
- Заштитата од електричен удар на активните и изолираните делови мора да се поврзе на таков начин што нема да може да се извади без алатки.
- Поврзете го приклучокот за струја со штекерот на крајот од монтажата. Проверете дали приклучокот за струја е пристапен по монтирањето.
- Доколку штекерот е лабав, не приклучувајте го приклучокот за струја.

- Не влечете го кабелот за да го исклучите апаратот од струја. Секогаш повлекувајте го приклучокот за струја.
- Користете само соодветни уреди за изолација: заштитни прекинувачи на линија, осигурувачи (осигурувачи на вртење извадени од држачот), заземјување и контактори.
- Електричната инсталација мора да има изолациски уред кој што ви овозможува да го исклучите апаратот од приклучокот за струја од сите полови. Изолацискиот уред мора да има контактен отвор со ширина од најмалку 3 мм.
- Целосно затворете ја вратата на апаратот пред да го поврзите главниот штекер со приклучокот за струја.
- Апаратот е снабден со приклучок и кабел за струја.

2.3 Употреба



ПРЕДУПРЕДУВАЊЕ!

Постои опасност од повреда, изгореници или струен удар или експлозија.

- Овој апарат е само за домашна употреба (внатре).
- Не менувајте ја спецификацијата на овој апарат.
- Осигурајте се дека отворите за вентилација не се блокирани.
- Не го оставајте апаратот да работи без надзор.
- Исклучете го апаратот по секоја употреба.
- Бидете внимателни кога ја отворате вратата на апаратот додека работи. Може да излезе врел воздух.
- Не ракувајте со апаратот со мокри раце или кога има контакт со вода.
- Не ја притискајте отворената врата.
- Не употребувајте го апаратот како работна површина или површина за складирање.
- Внимателно отворете ја вратата на апаратот. Користењето состојки со алкохол може да предизвика мешање на алкохол и воздух.
- Не дозволувајте искрите или отворен оган да дојдат во контакт со апаратот кога ќе ја отворите вратата.
- Не ставајте запаливи производи или предмети кои се мокри заедно со запаливи производи во апаратот, или во негова близина.



ПРЕДУПРЕДУВАЊЕ!

Опасност од оштетување на апаратот.

- За да спречите оштетување или избледување на емајлот:
 - не ставајте садови за во рерна или други предмети во апаратот директно на дното.
 - не ставајте алуминиумска фолија директно на дното на внатрешноста на апаратот.
 - не ставајте вода директно на жешкиот апарат.
 - не чувајте влажни јадења и храна во апаратот откако ќе завршите со готвење.
 - внимавајте кога ги отстранувате или монтирате додатоките.
- Обезбојувањето на емајлот или на не'рѓосувачкиот челик нема ефект врз работата на апаратот.
- Користете длабок сад за влажни колачи. Овошните сокови предизвикуваат дамки кои може да бидат трајни.
- Овој апарат е наменет само за готвење. Не смее да се користи во други цели, на пример за греење на просторија.
- Секогаш гответе со затворена врата на рерна.
- Ако апаратот е монтиран зад плоча од мебел (на пр. врата), вратата не смее да се затвора кога апаратот е во функција. Може да се насобере топлина и влага зад

затворена плоча на мебелот што може да предизвика последователно оштетување на апаратот, на мебелот или на подот. Не затворајте ја плочата на мебелот додека апаратот целосно не се излади по употребата.

2.4 Нега и чистење



ПРЕДУПРЕДУВАЊЕ!

Опасност од повреди, пожар или оштетување на апаратот.

- Пред одржување, исклучете го апаратот и извадете го приклучокот за струја од штекерот.
- Проверете дали апаратот е ладен. Постои опасност од кршење на стаклените плочи.
- Веднаш заменете ги стаклените плочи на вратата ако се оштетени. Стапете во контакт со Овластен сервисен центар.
- Бидете внимателни кога ја вадите вратата од апаратот. Вратата е тешка!
- Редовно чистете го апаратот за да спречите оштетување на површинскиот материјал.
- Чистете го апаратот со мека, влажна крпа. Користете само неутрални детергенти. Не користете абразивни производи, абразивни сунгери за чистење, растворувачи или метални предмети.
- Доколку користите спреј за печка, следете ги безбедносните инструкции на пакувањето.

2.5 Чистење со пиролиза



ПРЕДУПРЕДУВАЊЕ!

Опасност од повреди / Пожари / Хемиски испарувања (гасови) во режим на пиролиза.

- Пред да ја спроведете функцијата самостојно чистење со пиролиза или пред првата употреба, од внатрешноста на печката извадете ги следните работи:
 - сите остатоци од храна, масло или истурени маснотии / наслаги.
 - сите предмети што можат да се извадат (вклучително решетките, страничните шини итн., обезбедени од производот), особено нелепливите тенџериња, тавите, тацните, приборот итн.
- Внимателно прочитајте ги упатствата за чистење со пиролиза.
- Држете ги децата подалеку од апаратот додека работи Пиротичкото чистење. Апаратот станува многу жежок и испушта жежок воздух од предните вентилатори за ладење.
- Чистењето со пиролиза е операција на висока температура што може да ослободи испарувања од остатоците од готвењето и материјалите на садовите, и затоа на купувачите им се препорачува следново:
 - обезбедете добра вентилација за време и после секое чистење со пиролиза.
 - обезбедете добро проветрување за време и по првата употреба при максимална температура за работа.
- За разлика од луѓето, некои птици и влекачи може да бидат крајно чувствителни на потенцијалните испарувања што се испуштаат за време на чистењето на сите пиролитички рерни.
 - Отстранете ги сите миленичиња (посебно птици) од близината на местото на апаратот за време и после Пиролитичкото чистење и на почеток пуштете го да работи на максимална температура во добро проветрена просторија.

ОПИС НА ПРОИЗВОДОТ

- Малите домашни животни можат исто така да бидат многу чувствителни на локалните промени во температурата во близина на сите пиролитички рерни кога работи пиролитичката програма за самочистење.
- Нелепливите површини на тенџерињата, тавите, тацните, приборот и сл. може да се оштетат од пиролитичкото чистење на висока температура кај сите пиролитички рерни и можат да бидат и извор на испарувања со мала штетност.
- Испарувањата што ги испуштаат сите Пиролитички рерни / Остатоци од готвење се опишани како нештетни за луѓето, вклучително и за мали деца, или лица со хронични болести.

2.6 Внатрешна светилка



ПРЕДУПРЕДУВАЊЕ!

Опасност од струен удар.

- Во однос на светилите во внатрешноста на овој производ и резервните светилки што се продаваат посебно: Овие светилки се предвидени да издржат екстремни физички услови во апаратите за домаќинство, како што се температура, вибрации, влажност или се предвидени за давање сигнали за работната состојба на апаратот. Тие не се предвидени да се користат за други намени и не се погодни за осветлување простории во домот.
- Користете само светилки со истите спецификации.

2.7 Сервисирање

- За да го поправите апаратот контактирајте го Овластениот сервисен центар.
- Користете само оригинални резервни делови.

2.8 Расходување



ПРЕДУПРЕДУВАЊЕ!

Ризик од повреда или задушување.

- Исклучете го апаратот од приклучокот за струја.
- Извадете го електричниот кабел блиску до апаратот и фрлете го.
- Извадете ја кваката на вратата за да спречите затварање на деца или миленици во апаратот.

3. ОПИС НА ПРОИЗВОДОТ

3.1 Општ преглед

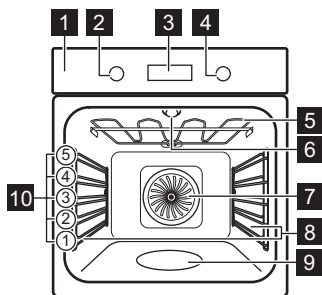

- 1** Контролна табла
- 2** Копче за функциите на греење
- 3** Екран
- 4** Контролно копче
- 5** Елемент за греење
- 6** Светилка
- 7** Вентилатор
- 8** Потпора за полици, мобилна
- 9** Позиции на полици
- 10** Изгравирана внатрешност

3.2 Accessories

Решетка

За садови за готвење, плехови за колачи, печења.

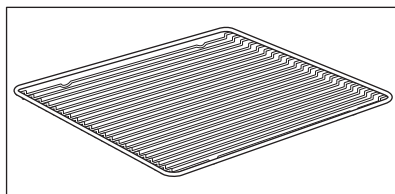

Плех за печење

За колачи и бисквити.

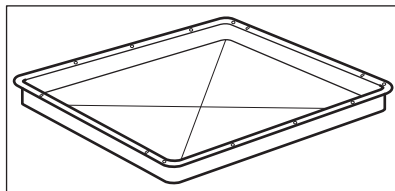

КАКО ДА СЕ ВКЛУЧИ И ИСКЛУЧИ ПЕЧКАТА

Тава за скара/печење месо

За печење десерти и месо или како плех за собирање на маснотиите.

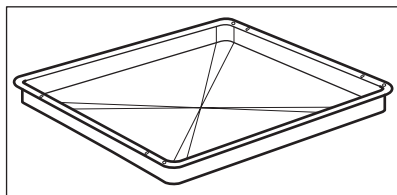

Телескопски шипки

За ставање и вадење на плехови и решетки полесно.

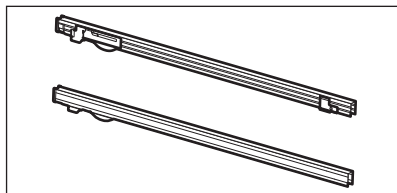







4. КАКО ДА СЕ ВКЛУЧИ И ИСКЛУЧИ ПЕЧКАТА

4.1 Тркалца коишто се повлекуваат

За да го користите апаратот, притиснете го тркалцето. Контролното копче излегува надвор.

4.2 Контролна табла

Сензорски полиња на контролната плоча					Притиснете на	Завртете го копчето
 Тајмер	 Брзо загревање	 Светло	 Lock	OK		

Изберете ја функцијата на греење за да ја вклучите рерната.

Свртете го копчето за функции на греење на позиција исклучено за да ја исклучите печката.

	Кога копчето за функции на греење е на позицијата исклучено, екранот оди на стендбај.
---	---

ПРЕД ПРВАТА УПОТРЕБА

	<p>Кога готвите, екранот ја покажува поставената температура, време во денот функции и други достапни опции.</p>
	<p>Екранот со максимален број на функции е поставен.</p>

Показатели за екранот

<p>Заклучување</p>	<p>Готвење со помош</p>	<p>Чистење</p>	<p>Нагодувања</p>	<p>Брзо загревање</p>
<p>Показател и за тајмер:</p>				

<p>Лента за прогрес - за температура или време.</p>	
---	--

<p>Показател за готвење на пара</p>	
-------------------------------------	--

5. ПРЕД ПРВАТА УПОТРЕБА

	<p>ПРЕДУПРЕДУВАЊЕ! Видете во поглавјата за заштита и сигурност.</p>
--	--

5.1 Првично чистење



<p>Пред првата употреба, исчистете ја празната рерна и поставете го времето:</p>			
			<p>00:00 Поставете го времето. Притиснете ОК.</p>

СЕКОЈДНЕВНА УПОТРЕБА

5.2 Прво предзагревање



Загрејте ја празната печка пред првата употреба.

1 чекор	Извадете ги сите додатоци и држачите на решетките што се вадат од печката.
2 чекор	Поставете ја максималната температура за функцијата:  Оставете ја печката да работи околу еден час.
3 чекор	Поставете ја максималната температура за функцијата:  Оставете ја печката да работи 15 минути.

 Печката може да испушта миризба и чад за време на предзагревање. Погрижете се да има доволен проток на воздух.



6. СЕКОЈДНЕВНА УПОТРЕБА



ПРЕДУПРЕДУВАЊЕ!



Видете во поглавјата за заштита и сигурност.

6.1 Како да поставите: Функции на греење

Почеток на готвењето	
Чекор 1	Чекор 2
	
Поставете функција на греење.	Поставете ја температурата.

Готвење на пара			
Проверете дали рерната е ладна.			
Чекор 1	Чекор 2	Чекор 3	Чекор 4

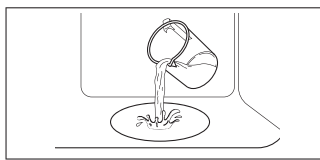
Готвење на пареа



			<p>Предзагрејте ја празната рерна околу 10 мин. за да направите влажност. Ставете ја храната во рерната.</p>
<p>Наполнете ја изгравираната внатрешност со вода од чешма.</p>	<p>Подесете ја функцијата за загревање на пареа.</p>	<p>Поставете ја температурата.</p>	
<p>i Максималниот капацитет на изгравираната внатрешност за вода е 250 ml. Не полнете ја гравираната внатрешност со вода за време на готвењето или кога рерната е жешка.</p>			

Кога ќе заврши готвењето со пареа:









Чекор 1	Чекор 2	Чекор 3
<p>Свртете го копчето за функции на греење на позиција исклучено за да ја исклучите рерната.</p>	<p>Внимателно отворете ја вратата. Ослободената пареа може да предизвика изгореници.</p>	<p>Проверете дали рерната е ладна. Извадете ја преостаната вода од изгравираната внатрешност.</p>

6.2 Функции за греење

Стандардни функции на греење

Функција на греење	Примена
 <p>Готвење со вентилатор</p>	<p>За печење на три решетки истовремено и за сушење храна. Поставете ја температурата за 20 - 40 °C пониска отколку за Конвенционално готвење.</p>
 <p>Конвенционално готвење</p>	<p>За печење храна и месо на едно ниво на полицата.</p>

СЕКОЈДНЕВНА УПОТРЕБА

Функција на греење	Примена
 SteamBake	За додавање влажност за време на готвењето. За постигнување на вистинската боја и крцкава кора при печење. За да биде посочно за време на повторното загревање. За правење зимница од зеленчук и овошје.
 Функција за пица	За печење пица. За појако печење и крцкав долен дел.
 Долен грејач	За печење колачи со крцкав долен дел и за конзервирање храна.
 Замрзната храна	За да ја направи лесно приготливата храна (на пр. пржени компирчиња, печени компири или крцкави ролнички) крцкава.
 Печете со влажен воздух	Функцијата е направена за штедење на електрична енергија за време на готвењето. Кога ја користите оваа функција, температурата во внатрешноста може да биде различна од поставената температура. Преостаната топлина е искористена. Јачината на топлината може да биде намалена. За повеќе информации видете во поглавјето „Секојдневна употреба“, Забелешки за: Печете со влажен воздух.
 Скара	За печење на скара на тенки парчиња храна и за печење тостови леб.
 Турбо-печење	За печење големи парчиња месо или живина со коски на една позиција на решетка. За запекнување и потпекнување.
 Мени	За да влезете во менито: Готвење со помош, Чистење, Нагодувања.

6.3 Забелешки за: Печете со влажен воздух

Оваа функција беше искористена за усогласување со класата за енергетска ефикасност и барањата за екодизајн во согласност со ЕУ 65/2014 и ЕУ 66/2014. Тестови според EN 60350-1.

Вратата на рерната треба да биде затворена за време на готвењето со што функцијата не би се прекинала и за да се осигурате дека рерната работи со највисока можна енергетска ефикасност.

Кога ќе ја користите оваа функција, светлото автоматски се исклучува после 30 секунди.



За упатства за готвење видете во поглавјето „Совети и помош“, Печете со влажен воздух. За општи препораки за заштеда на енергија видете во поглавјето „Енергетска ефикасност“, Заштеда на енергија.

6.4 Како да поставите: Готвење со помош

Секое јадење во ова подмени има препорачана функција и температура. Можете да ги прилагодите времето и температурата за време на готвењето.

Готвење со помош - користете го за да подготвите јадење брзо со стандардните поставки:			
Чекор 1	Чекор 2	Чекор 3	Чекор 4
			
Влезете во менито.	Изберете Готвење со помош. Притиснете ОК.	Изберете го јадењето. Притиснете ОК.	Ставете го јадењето во рерна. Потврдете ја поставката.

6.5 Готвење со помош со рецепти

Легенда	
	Износ на вода за функцијата со пареа.
	Загрејте ја рерната пред готвење.
	Ниво на решетка.







Кога завршува функцијата, проверете дали храната е готова.

Јадење	Тежина	Ниво на решетка / додаток	Времетраење
Говедско месо 			











СЕКОЈДНЕВНА УПОТРЕБА

	Јадење	Тежина	Ниво на решетка / додаток	Времетраење
P1	Печено говедско, полуживо	1 - 1,5 kg; парчиња со дебелина 4 - 5 cm	☐ 2; плех за печење Пржете го месото неколку минути во жешка тава. Вметнете во рерната.	40 мин
P2	Печено говедско, средно			50 мин
P3	Печено говедско, добро печено			60 мин
P4	Стек, средно печен	180 - 220 g по парче; парчиња со дебелина 3 cm	☐☐ 3; печени јадења на решетка Пржете го месото неколку минути во жешка тава. Вметнете во рерната.	15 мин
P5	Печено говедско месо / динстано (ребро, тркалезно, дебело парче)	1,5 - 2 kg	☐ 2; печени јадења на решетка Пржете го месото неколку минути во жешка тава. Додадете течност Вметнете во рерната.	120 мин
P6	Печено говедско, полуживо (бавно готвење)	1 - 1,5 kg; парчиња со дебелина 4 - 5 cm	☐ 2; плех за печење Користете ги вашите омилени зачни или само сол и свежо мелен црн бибер. Пржете го месото неколку минути во жешка тава. Вметнете во рерната.	75 мин
P7	Печено говедско, средно (бавно готвење)			85 мин
P8	печено говедско, добро печено (бавно готвење)			130 мин

















СЕКОЈДНЕВНА УПОТРЕБА

	Јадење	Тежина	Ниво на решетка / додаток	Времетраење
P9	Филети, полуживи (бавно готвење)	0,5 - 1,5 kg; парчиња со дебелина 5 - 6 cm	 2; плех за печење Користете ги вашите омилен зачини или само сол и свежо мелен црн бибер. Пржете го месото неколку минути во жешка тава. Вметнете во рерната.	75 мин
P10	Филети, средно печени (бавно готвење)			90 мин
P11	Филети, добро печени (бавно готвење)			120 мин
Телешко 				
P12	Печено телешко (на пр. грб)	0,8 - 1,5 kg; парчиња со дебелина 4 cm	 2; печени јадења на решетка Користете ги вашите омилен зачини. Додадете течност Печете го покриено.	80 мин
Свинско 				
P13	Печен свински врат или грб	1,5 - 2 kg	 2; печени јадења на решетка По половина од времето за готвење превртете го месото.	120 мин
P14	Влечено свинско LTC	1,5 - 2 kg	 2; плех за печење Користете ги вашите омилен зачини. По половина од времето за готвење превртете го месото за подеднакво потпекување.	215 мин
P15	Плешка, свежа	1 - 1,5 kg; парчиња со дебелина 5 - 6 cm	 2; печени јадења на решетка Користете ги вашите омилен зачини.	55 мин





















СЕКОЈДНЕВНА УПОТРЕБА













	Јадење	Тежина	Ниво на решетка / додаток	Времетраење
P16	Ребро	2 - 3 kg; користете сирово, тенки ребра со дебелина 2 - 3 cm	 3; длабока тава Додадете течност да го покрие дното на јадењето. По половина од времето за готвење превртете го месото.	90 мин
Јагнешко 				
P17	Јагнешки бут со коски	1,5 - 2 kg; парчиња со дебелина 7 - 9 cm	 2; печење јадења на плех за печење Додадете течност По половина од времето за готвење превртете го месото.	130 мин
Живина 				
P18	Цело пиле	1 - 1,5 kg; свежо	 2;  200 ml; потпечено јадење на плех за печење Користете ги вашите омилени зачини. По половина од времето за готвење превртете го пилешкото месо за подеднакво потпекување.	60 мин
P19	Половина пиле	0,5 - 0,8 kg	 3 ; плех за печење Користете ги вашите омилени зачини.	40 мин
P20	Пилешки гради	180 - 200 g по парче	  2; потпечено јадење на решетка Користете ги вашите омилени зачини. Пржете го месото неколку минути во жешка тава.	25 мин
P21	Пилешки копани, свежи	-	 3; плех за печење Ако прво ги мариниравте пилешките копани, поставете пониска температура и готвење ги подолго.	30 мин

СЕКОЈДНЕВНА УПОТРЕБА

	Јадење	Тежина	Ниво на решетка / додаток	Времетраење
P22	Цела патка	2 - 3 kg	 2; печени јадења на решетка Користете ги вашите омилени зачини. Ставете го месото во сад за печење. По половина од времето за готвење превртете го месото од патка.	100 мин
P23	Цела гуска	4 - 5 kg	 2; длабока тава Користете ги вашите омилени зачини. Ставете го месото во длабок плех за печење. По половина од времето за готвење превртете го гускиното месо.	110 мин
Друго 				
P24	Ќофте	1 kg	 2; решетка Користете ги вашите омилени зачини.	60 мин
 Риба				
P25	Цела риба, на скара	0,5 - 1 kg по риба	 2 ; плех за печење Наполнете ја рибата со путер и користете ги вашите омилени зачини и билки.	30 мин
P26	Филети од риба	-	  3; потпешено јадење на решетка Користете ги вашите омилени зачини.	20 мин
Печење на слатки / десерти   				
P27	Торта од сирење	-	 2;  28 cm плех со федер на решетка	90 мин
P28	Колач со јаболка	-	 2;  100 - 150 ml; плех за печење	60 мин
P29	Пита со овошје	-	 2; модла за пита на решетка	40 мин





СЕКОЈДНЕВНА УПОТРЕБА

	Јадење	Тежина	Ниво на решетка / додаток	Времетраење
P30	Пита со јаболка	-	 2;  100 - 150 ml  модла за пита од 22 см на решетка	60 мин
P31	Чоколадни колачиња	2 kg	 3; длабока тава	30 мин
P32	Чоколадни мафини	-	 2;  100 - 150 ml; плех за мафини на решетка	30 мин
P33	Куглоф	-	 2; сад за погача на решетка	50 мин
Зеленчук / гарнир   				
P34	Печени компири	1 kg	 2; плех за печење Ставете цели компири со лушпа на плех за печење.	50 мин
P35	Парчиња	1 kg	 3; плех за печење поставена со хартија за печење Користете ги вашите омилени зачини. Исечете ги компирите на парчиња.	35 мин
P36	Печен мешан зеленчук	1 - 1,5 kg	 3; плех за печење поставена со хартија за печење Користете ги вашите омилени зачини. Исечете ги зеленчуците на парчиња.	30 мин
P37	Крокети, замрзнати	0,5 kg	 3; плех за печење	25 мин
P38	Pommes, замрзнати	0,75 kg	 3; плех за печење	25 мин
Потпечени, леб и пица   				
P39	Лазања / јуфки	1 - 1,5 kg	 2; потпечено јадење на решетка	45 мин
P40	Потпечени компири	1 - 1,5 kg	 1; потпечено јадење на решетка	50 мин

	Јадење	Тежина	Ниво на решетка / додаток	Времетраење
P41	Свежа пица, тенка	-	  2;  100 ml плек за печење поставен со хартија за печење	15 мин
P42	Свежа пица, дебела	-	  2;  100 ml; плек за печење поставена со хартија за печење	25 мин
P43	Киш со јајца	-	 2; тава за печење на решетка	45 мин
P44	Багети / чијабата / бел леб	0,8 kg	  3;  150 ml; плек за печење поставен со хартија за печење Повеќе време е потребно за бел леб.	30 мин
P45	Зрна / 'рж / црн леб од зрна во тава за леб	1 kg	  2;  150 ml; плек за печење поставен со хартија за печење / решетка	45 мин

7. ФУНКЦИИ НА ЧАСОВНИКОТ

7.1 Функции на часовник

Функција на часовник	Примена
	Потсетник во минути. Кога ќе истече тајмерот, се огласува звучен сигнал.
	Време на готвење. Кога тајмерот завршува се огласува сигнал и запира функцијата на греење.
	Одложен почеток. За одложување на почетокот и/или крајот на готвењето.
	Време на работење. Максимумот е 23 ч 59 мин. Оваа функција нема влијание врз работата на рерната. За да го вклучите и исклучите Време на работење изберете: Мени, Нагодувања.

ФУНКЦИИ НА ЧАСОВНИКОТ

7.2 Како да поставите: Функции на часовник

Како да поставите: Време во денот		
Чекор 1	Чекор 2	Чекор 3
		
За да го промените времето во денот влезете во менито и изберете Поставки, Време во денот	Поставете го часовникот.	Притиснете: ОК.

Како да поставите: Потсетник во минути			
Чекор 1	На екранот се прикажува: 0:00 	Чекор 2	Чекор 3
			
Притиснете: 	Поставете ја Потсетник во минути.	Притиснете: ОК.	
 Тајмерот започнува да одбројува назад веднаш.			

Како да поставите: Време на готвење				
Чекор 1	Чекор 2	На екранот се прикажува: 0:00  STOP	Чекор 3	Чекор 4
				
Одберете функција за греење и поставете ја температурата.	Притиснете неколку пати: 	Поставете го времето на готвење.	Притиснете: ОК.	
 Тајмерот започнува да одбројува назад веднаш.				

НАЧИН НА КОРИСТЕЊЕ: ДОДАТОЦИ

Како да поставите: Одложен почеток							
Чекор 1	Чекор 2		Чекор 3	Чекор 4		Чекор 5	Чекор 6
		На екранот се покажува новото време.  ПОЧЕТ ОК			На екранот се прикажува: --:--  КРАЈ		
Одберете ја функцијата на греење .	Притиснете неколку пати:  .		Поставете го времето на почеток.	Притиснете: ОК.		Поставете го времето на крај.	Притиснете: ОК.
 Тајмерот започнува да одбројува на поставеното време на почеток.							

8. НАЧИН НА КОРИСТЕЊЕ: ДОДАТОЦИ

8.1 Вметнување на додатоци

Мало вовлекување на горниот дел ја зголемува сигурноста. Вовлечените делови исто така функционираат и како уреди против остри рабови. Големият раб околу полицата го спречува садот за готвење да се излизга.



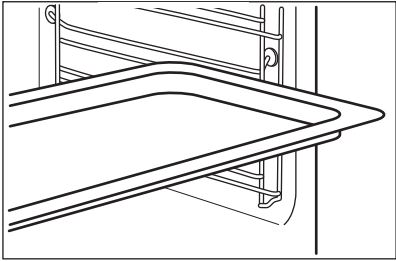
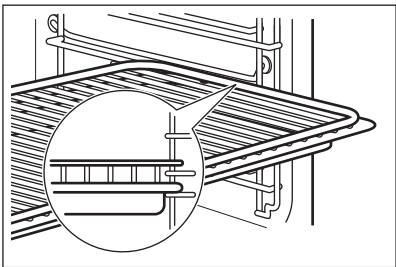

<p>Решетка: Турнете ја решетката меѓу водилките на држачот за решетката .</p>	
--	--

ДОПОЛНИТЕЛНИ ФУНКЦИИ

<p>Плех за печење /Длабока тава: Турнете ја решетката меѓу водилките на држачот за решетката.</p>	
<p>Решетка, Плех за печење /Длабока тава: Турнете го плехот за печење помеѓу водилките на држачот и решетката на водилките горе.</p>	



9. ДОПОЛНИТЕЛНИ ФУНКЦИИ

9.1 Заклучување

<p>Оваа функција спречува случајно менување на функцијата на рерната.</p>		
<p>Вклучете ја кога рерната работи - поставеното готвење продолжува, контролната плоча е заклучена. Вклучете ја кога рерната е исклучена - рерната не може да се вклучи, контролната плоча е заклучена.</p>		
	<p> - притиснете и држете за да ја вклучите функцијата. Се огласува звучен сигнал.</p>	<p> - притиснете и држете за да исклучите.</p>
<p> 3 x  - трепка кога бравата е вклучена.</p>		

9.2 Автоматско исклучување

Заради безбедносни причини, печката автоматски се исклучува после некое време, ако функцијата на греење на печката работи и не се променети поставките.

 (°C)	 (ч)
30 - 115	12.5
120 - 195	8.5
200 - 245	5.5
250 - максимум	3

Автоматското исклучување не работи со следните функции: Светло, Одложен почеток.



9.3 Вентилатор за ладење



Кога работи печката, вентилаторот за ладење се вклучува автоматски за да ги одржува ладни површините на печката. Ако ја исклучите печката, вентилаторот за ладење може да продолжи да работи сè додека печката не се олади.

10. ПОМОШ И СОВЕТИ

10.1 Печете со влажен воздух

За најдобри резултати следеете ги препораките дадени во табелата подолу. Користете го третото ниво на решетката.

	 (°C)	 (мин)
Потпечена паста	200 - 220	45 - 55
Потпечени компири	180 - 200	70 - 85
Мусака	170 - 190	70 - 95
Лазања	180 - 200	75 - 90
Канелони	180 - 200	70 - 85
Пудинг со тесто	190 - 200	55 - 70
Пудинг од ориз	170 - 190	45 - 60
Колач со јаболка, направен од пандишпан (тркалезен Плех)	160 - 170	70 - 80

	 (°C)	 (МИН)
Бел леб	190 - 200	55 - 70

10.2 Печете со влажен воздух - препорачани додатоци







Употребете темни плехови и садови кои ја одбиваат светлината. Тие подобро ја апсорбираат топлината од светлата боја и садовите кои ја одбиваат светлината.

			
Тавче за пица	Сад за печење	Керамички сад	Рамна тава за печење колачи
Темна, која не одбива светлина 28 см дијаметар	Темна, која не одбива светлина 26 см дијаметар	Керамика 8 см дијаметар, 5 см висина	Темна, која не одбива светлина 28 см дијаметар

10.3 Табели за готвење за институти за тестирање

Информации за институти за тестирање

Тестови според: EN 60350, IEC 60350.

 ПЕЧЕЊЕ НА ЕДНО НИВО. Печиво во калапи				
		 (°C)	 (МИН)	
Посен пандишпан	Готвење со вентилатор	140 - 150	35 - 50	2
Посен пандишпан	Конвенционално готвење	160	35 - 50	2
Пита со јаболка, 2 плеха Ø20 см	Готвење со вентилатор	160	60 - 90	2



ПЕЧЕЊЕ НА ЕДНО НИВО. Печиво во калапи





		 (°C)	 (МИН)	
Пита со јаболка, 2 плеха Ø20 cm	Конвенционално готвење	180	70 - 90	1



ПЕЧЕЊЕ НА ЕДНО НИВО. Бисквити



Користете го третото ниво на решетката.

		 (°C)	 (МИН)
Леб / Печива во ленти	Готвење со вентилатор	140	25 - 40
Леб / Печива во ленти, предзагрејте ја празната рерна	Конвенционално готвење	160	20 - 30
Мали колачиња, 20 парчиња по плех, предзагрејте ја празната рерна	Готвење со вентилатор	150	20 - 35
Мали колачиња, 20 парчиња по плех, предзагрејте ја празната рерна	Конвенционално готвење	170	20 - 30

НЕГА И ЧИСТЕЊЕ



ПЕЧЕЊЕ НА ПОВЕЌЕ НИВОА. Бисквити

		 (°C)	 (мин)	
Леб / Печива во ленти	Готвење со вентилатор	140	25 - 45	1 / 4
Мали колачиња, 20 парчиња по плех, предзагрејте ја празната рерна	Готвење со вентилатор	150	23 - 40	1 / 4
Посен пандишпан	Готвење со вентилатор	160	35 - 50	1 / 4



ПЕЧЕЊЕ НА СКАРА



Презагрејте ја празната печка 5 минути.



Скара со поставена максимална температура.

		 (мин)	
Тост	Скара	1 - 3	5
Говедски стек, завртете на половина време	Скара	24 - 30	4



11. НЕГА И ЧИСТЕЊЕ



ПРЕДУПРЕДУВАЊЕ!

Видете во поглавјата за заштита и сигурност.

11.1 Забелешки за чистењето

 <p>Средства за чистење</p>	<p>Предниот дел на печката чистете го со мека крпа натопена со топла вода и средство за чистење.</p>
	<p>Користете раствор за чистење за да ги исчистите металните површини.</p>
	<p>Чистете ги дажките со благ детергент.</p>
 <p>Секојдневна употреба</p>	<p>Чистете ја внатрешноста по секоја употреба. Насобирањето мрснотии или други остатоци од храна може да резултира со пожар.</p>
	<p>Не чувајте ја храната во печката подолго од 20 минути. Исушете ја внатрешноста со мека крпа после секоја употреба.</p>
 <p>Додатоци</p>	<p>Чистете го целиот прибор после секоја употреба и оставете го да се исуши. Користете мека крпа натопена со топла вода и средство за чистење. Не чистете го приборот во машина за миење садови.</p>
	<p>Не чистете ги додатоците што не се лепат со употреба на абразивни средства за чистење или со предмети со остри рабови.</p>

11.2 Начин на чистење: Втиснување во шуплината

Исчистете ја изгравираната внатрешност за да ги отстраните остатоците од бигор по готвењето со пареа.

Чекор 1	Чекор 2	Чекор 3
<p>Истурете: 250 ml бел оцет во изгравираната внатрешност. Користете 6% вински оцет без адитиви.</p>	<p>Оставете винскиот оцет да го раствори преостанатиот бигор на собна температура 30 минути.</p>	<p>Исчистете ја внатрешноста со топла вода и мека крпа.</p>
<p>За функцијата: SteamBake чистете ја рерната на секои 5 - 10 циклуси на готвење.</p>		

11.3 Како да отстранете: Држачи на решетки

Извадете ги држачите за решетки за да ја исчистите печката.

НЕГА И ЧИСТЕЊЕ

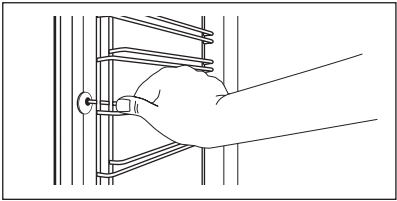
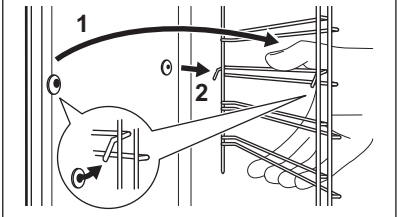
1 чекор	Исклучете ја печката се додека не се олади.	
2 чекор	Повлечете го предниот дел од држачите настрана од страничниот сид.	
3 чекор	Повлечете го задниот дел од држачите настрана од страничниот сид и извадете го.	
4 чекор	Монтирајте ги држачите на решетките по обратен редослед. Иглите за држење на телескопските шини мора да се насочени напред.	

11.4 Начин на користење: Чистење со пиролиза

Чистете ја рерната со Чистење со пиролиза.



ПРЕДУПРЕДУВАЊЕ!

Постои ризик од изгореници.



ВНИМАНИЕ!



Ако има други апарати монтирани во истиот плакар, немојте да ги користите истовремено со оваа функција. Тоа може да ја оштети печката.

Пред Чистење со пиролиза:

Исклучете ја печката и почекајте да се олади.	Извадете ги сите додатоци и држачите за решетките кои може да се извадат.	Исчистете го подот на рерната и стаклото на внатрешната врата со топла вода, мека крпа и благ детергент.
---	---	--

Чистење со пиролиза

Чекор 1	Влезете во менито: Чистење  .	
Опција	Времетраење	
C1 - Лесно чистење	1 h	

Чистење со пиролиза	
C2 - Нормално чистење	1 h 30 min
C3 - Темелно чистење	3 h
Чекор 2	ОК - притиснете за да ја изберете програмата за чистење.
Чекор 3	ОК - притиснете го за да започне чистењето.
Чекор 4	После чистењето, завртете го тркалцето за функциите на греење на печката на положбата исклучено.
 За време на чистењето, светилката во печката е исклучена.	
Кога печката е на поставената температура, вратата се заклучува. Додека не се отклучи вратата, екранот прикажува:  .	

Кога ќе заврши чистењето:		
Исклучете ја печката и почекајте додека не се олади.	Исчистете ја внатрешноста со мека крпа.	Отстранете ги остатоците од дното на внатрешноста.

11.5 Потсетник за чистење

Рерната ве потсетува кога да ја исчистите со чистење со пиролиза.	
 трепка на екранот 5 секунди по секое готвење.	За да го исклучите потсетникот внесете Мени и изберет Нагодувања, Потсетник за чистење.

11.6 Како да извадите и да монтирате: Врата

Можете да ја извадите вратата и внатрешните стаклени плочи за да ги исчистите. Бројот на стаклени плочи е различен за различни модели.

 ПРЕДУПРЕДУВАЊЕ! Вратата е тешка.

 ВНИМАНИЕ! Внимателно ракувајте со стаклото, особено околу рабовите на предната плоча. Стаклото може да се скрши.

НЕГА И ЧИСТЕЊЕ

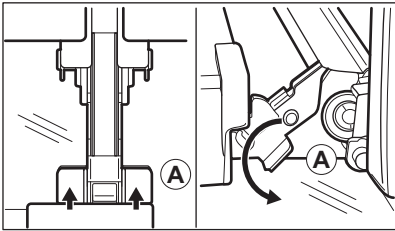
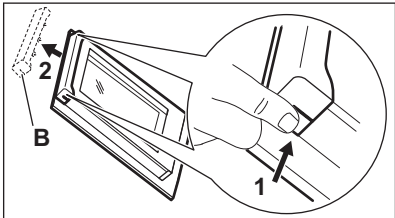
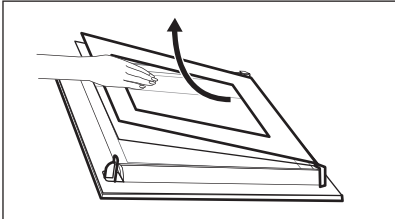
<p>Чекор 1</p>	<p>Целосно отворете ја вратата.</p>	
<p>Чекор 2</p>	<p>Подигнете ги и притиснете ги стегите (A) на двете шарки на вратата.</p>	
<p>Чекор 3</p>	<p>Затворете ја вратата на печката до првата позиција за отворање (агол од околу 70°). Држете ја вратата на двете страни и повлечете ја од печката под нагорен агол. Положете ја вратата со надворешната страна надолу врз мека крпа на стабилна површина.</p>	
<p>Чекор 4</p>	<p>Држете ја облогата на вратата (B) на горниот раб на вратата на двете страни и турнете навнатре за да се отпушти заптивката.</p>	
<p>Чекор 5</p>	<p>Повлечете ја облогата на вратата напред и извадете ја.</p>	
<p>Чекор 6</p>	<p>Држете ги стаклените плочи на вратата на горниот раб една по една и повлечете ги нагоре за да ги извадите од водилката.</p>	
<p>Чекор 7</p>	<p>Исчистете ја стаклената плоча со вода и сапун. Внимателно избришете ја стаклената плоча. Не чистете ги стаклените плочи во машина за миење садови.</p>	
<p>Чекор 8</p>	<p>После чистењето, направете ја горенаведената постапка по обратен редослед.</p>	
<p>Чекор 9</p>	<p>Помалата плоча треба да се намести прва, а потоа поголемата и вратата. Проверете дали стаклата се поставени во правилна положба, инаку површината на вратата може прекумерно да се загрее.</p>	

11.7 Како да замените: Светло



ПРЕДУПРЕДУВАЊЕ!

Опасност од струен удар.
Ламбата може да биде жешка.

Пред да ја замените светилката:

1 чекор	2 чекор	3 чекор
Вклучете ја печката. Почекајте додека печката не се олади.	Откачете ја печката од електричното напојување.	Ставете крпа на дното на внатрешноста.

Горно светло

1 чекор	Свртете го стакленото капаче за да го извадите.	
2 чекор	Исчистете го стаклениот капак.	
3 чекор	Заменете ја светилката со соодветна светилка отпорна на топлина до 300 °C.	
4 чекор	Монтирајте го стакленото капаче.	

12. РЕШАВАЊЕ НА ПРОБЛЕМИ



ПРЕДУПРЕДУВАЊЕ!

Видете во поглавјата за заштита и сигурност.

12.1 Што да се направи ако...

Ако некој случај не е вклучен во оваа табела, контактирајте со Овластен сервисен центар.

Печката не се вклучува или не се загрева	
Проблем	Проверете дали...
Не можете да ја вклучите или да ракувате со рерната.	Рерната е неправилно поврзана со доводот за струја.

РЕШАВАЊЕ НА ПРОБЛЕМИ



Печката не се вклучува или не се загрева

Рерната не се загрева.	Исклучено е автоматското исклучување.
Рерната не се загрева.	Вратата на рерната е заклучена.
Рерната не се загрева.	Не е избиев осигурувач.
Рерната не се загрева.	Исклучена е бравата за деца.



Компоненти

Проблем	Проверете дали...
Светлото е исклучено.	Печете со влажен воздух - е вклучен.
Светлото не работи.	Светилката е прегорена.



Кодови за грешки

На екранот се прикажува...	Проверете дали...
Err C3	Вратата на рерната е затворена или бравата на вратата е исправна.
Err F102	Вратата на рерната е заклучена.
Err F102	Бравата на вратата не е расипана.
00:00	Прекината е струјата. Поставете го точното време.

Ако на екранот се покажува код за грешка што не е во оваа табела, исклучете го осигурувачот во куќата и вклучете го повторно за рестартирање на рерната. Ако повторно се појави проблемот, стапете во контакт со Овластениот сервисен центар.



Чистење

Проблем	Проверете дали...
Водата истекува од изгравираната внатрешност.	Има премногу вода во изгравираната внатрешност.

12.2 Податоци за сервис

Ако не можете самите да го решите проблемот, обратете се кај Вашиот дилер или во овластениот сервисен центар.

Потребните податоци за сервисниот центар се на плочката со спецификации. Плочката со спецификации се наоѓа на предната рамка во внатрешноста на печката. Не отстранувајте ја плочката со спецификации од внатрешноста на печката.

Ви препорачуваме податоците да ги впишете тука:	
Модел (MOD.)
Број на производ (PNC)
Сериски број (S.N.)

13. ЕНЕРГЕТСКА ЕФИКАСНОСТ

13.1 Информации за производот и Страница за информации за производот*

Име на снабдувачот	AEG
Идентификација на моделот	BPB351160M 944188506 BPS351160M 944188507
Показател за енергетска ефикасност	81.2
Класа на енергетска ефикасност	A+
Потрошувачка на енергија кај нормално полнење, конвенционален режим	1.09 kWh/циклус
Потрошувачка на енергија кај нормално полнење, режим со форсиран вентилатор	0.69 kWh/циклус

Број на празнини	1	
Извор на топлина	Електрицитет	
Волумен	71 l	
Вид печка	Вградена печка	
Маса	BPB351160M	34.0 kg
	BPS351160M	34.0 kg

* За Европската Унија, согласно Прописот на ЕУ 65/2014 и 66/2014.
 За Република Белорусија, согласно СТБ 2478-2017, Додаток G; СТБ 2477-2017, Додатоци А и В.
 За Украина, согласно 568/32020.

Класа на енергетска ефикасност применлива за Русија.

EN 60350-1 - Електрични апарати за готвење во домаќинство - Дел 1: Шпорети, печки, печки на гас и скари - Методи на мерење на работата.

13.2 Заштеда на енергија



Печката има функции кои ви помагаат да заштедите енергија при секојдневното готвење.

Проверете дали вратата на печката е правилно затворена кога работи печката. Не ја отворајте вратата многу често за време на готвењето. Одржувајте го чист дихтунгот на вратата и проверете дали е добро фиксиран на својата позиција.

Користете метални садови за да го зголемите штедењето на енергија.

Кога е можно, не ја предзагревајте печката пред готвење.

Правете колку што е можно помали паузи меѓу готвењето кога правите повеќе јадења истовремено.

Готвење со вентилатор

Кога е можно, користете ги функциите за готвење со вентилатор за да заштедите енергија.

Преостаната топлина

Вентилаторот и светилката продолжуваат со работа. Кога ќе ја исклучите печката, екранот ја покажува преостанатата топлина. Можете да ја употребите топлината за да ја одржите храната топла.

Кога траењето на готвењето е подолго од 30 минути, намалете ја температурата на печката за минимум 3 - 10 минути пред крајот од готвењето. Преостанатата топлина во рерната ќе продолжи да готви.

Користете ја преостанатата топлина за загревање храна.

Одржување на топлина кај храната

Одберете ја најниската поставка за температура за да ја искористите преостаната топлина и да го одржите јадењето топло. Показателот за преостаната топлина или температура се појавува на екранот.

Готвење со исклучена светилка

Исклучете ја светилката за време на готвењето. Вклучете ја кога ќе имате потреба.

Печете со влажен воздух

Функција за штедење на електрична енергија за време на готвењето.



Кога ја користите оваа функција, лампата автоматски се исклучува по 30 сек. Можете да ја вклучите светилката повторно но оваа акција ќе ги намали очекуваните штедења на енергија.

14. СТРУКТУРА НА МЕНИ

14.1 Мени

	≡ - изберете за да внесете Мени.
---	----------------------------------

Мени структура

Готвење со помош 	Чистење 	Нагодувања 
--	---	--

Чекор 1	Чекор 2	Чекор 3	Чекор 4	Чекор 5
	 OK	 O1 - O11	 OK	
Изберете Мени, Нагодувања.	Потврдете ја поставката.	Изберете ја поставката.	Потврдете ја поставката.	Прилагодете ја вредноста и притиснете OK.



Нагодувања

O1	Време во денот	Промени	O2	Осветленост на екранот	1 - 5
O3	Тонови на копчиња	1 - Свирење 2 - Клик 3 - Звукот е исклучен	O4	Јачина на звучниот сигнал	1 - 4
O5	Време на работење	Вклучено / Исклучено	O6	Светло	Вклучено / Исклучено

СТРУКТУРА НА МЕНИ

Нагодувања					
07	Брзо загревање	Вклучено / Исклучено	08	Потсетник за чистење	Вклучено / Исклучено
09	Демо-режим	Шифра за активирање : 2468	010	Верзија на софтвер	Проверка
011	Ресетирај ги сите нагодувања	Да / Не			

15. ГРИЖА ЗА ОКОЛИНАТА

Рециклирајте ги материјалите со симболот . Ставете ја амбалажата во соодветни контејнери за да ја рециклирате. Помогнете во заштитата на животната средина и човековото здравје и рециклирајте го отпадот од електрични и електронски апарати. Не фрлајте ги апаратите означени со симболот  во отпадот од домаќинството. Вратете го производот во вашиот локален капацитет за рециклирање или контактирајте ја вашата општинска канцеларија.

ЗА САВРШЕНЕ РЕЗУЛТАТЕ

Хвала што сте изабрали овај АЕГ производ. Створили смо га тако да пружа изванредне перформансе током много година рада, уз иновативне технологије које олакшавају живот и функције које нећете наћи код обичних уређаја. Одвојте неколико минута да прочитате како да од њега добијете максимум.

Посетите наш сајт да:



Прибавите савете за коришћење, брошуре и информације за решавање проблема, сервис и поправку:

www.aeg.com/support



Региструјте производ ради боље услуге:

www.registreaeg.com



Купите прибор, потрошни материјал и оригиналне резервне делове за свој уређај:

www.aeg.com/shop



За још више рецепата, савета и метода решавања проблема преузмите апликацију **My AEG Kitchen**.



КОРИСНИЧКА ПОДРШКА И СЕРВИС

Увек користите оригиналне резервне делове.

Када контактирате овлашћени сервисни центар, водите рачуна да код себе имате следеће податке: Модел, број производа, серијски број.

Подаци могу да се пронађу на плочици са техничким карактеристикама.

 Упозорење/опрез – информације о безбедности

 Опште информације и савети

 Информације о животној средини

Задржано право измена.

САДРЖАЈ

1. ИНФОРМАЦИЈЕ О БЕЗБЕДНОСТИ.....	368	2.6 Унутрашње осветљење.....	374
1.1 Безбедност деце и осетљивих		2.7 Услуга.....	374
особа.....	368	2.8 Одлагање.....	374
1.2 Опште мере безбедности.....	369	3. ОПИС ПРОИЗВОДА.....	374
2. БЕЗБЕДНОСНА УПУТСТВА.....	370	3.1 Општи приказ.....	375
2.1 Монтажа.....	370	3.2 Прибор.....	375
2.2 Прикључење на електричну		4. КАКО СЕ УКЉУЧУЈЕ И ИСКЉУЧУЈЕ	
мрежу.....	371	ПЕРНА.....	376
2.3 Употреба.....	372	4.1 Дугмад која се увлаче.....	376
2.4 Нега и чишћење.....	373	4.2 Командна табла.....	376
2.5 Пиролитичко чишћење.....	373		

5. ПРЕ ПРВЕ УПОТРЕБЕ.....	377	10.2 Влажно печење уз вентилатор - препоручени прибор.....	392
5.1 Прво чишћење.....	377	10.3 Табеле кувања за институте за тестирање.....	392
5.2 Иницијално предгревање.....	378	11. НЕГА И ЧИШЋЕЊЕ.....	394
6. СВАКОДНЕВНА УПОТРЕБА.....	378	11.1 Напомене у вези са чишћењем.....	395
6.1 Како да подесите: Функције загревања.....	378	11.2 Како да очистите: Удубљења у унутрашњости.....	395
6.2 Функције загревања.....	379	11.3 Како да извадите: Подршке за решетке.....	395
6.3 Напомене у вези са: Влажно печење уз вентилатор.....	380	11.4 Како да користите: Пиролитичко чишћење.....	396
6.4 Како да подесите: Потпомогнута припрема.....	381	11.5 Подсетник за чишћење.....	397
6.5 Потпомогнута припрема са рецептима.....	381	11.6 Како да скинете и монтирате: Врата.....	397
7. ФУНКЦИЈЕ САТА.....	387	11.7 Како да замените: Лампица....	398
7.1 Функције сата.....	387	12. РЕШАВАЊЕ ПРОБЛЕМА.....	399
7.2 Како да подесите: Функције сата.....	388	12.1 Шта учинити ако.....	399
8. КАКО ДА КОРИСТИТЕ: ПРИБОР.....	389	12.2 Подаци о сервисирању.....	401
8.1 Убацивање прибора.....	389	13. ЕНЕРГЕТСКА ЕФИКАСНОСТ.....	401
9. ДОДАТНЕ ФУНКЦИЈЕ.....	390	13.1 Информације о производу и Лист са информацијама о производу*....	401
9.1 Контролна брава.....	390	13.2 Уштеда енергије.....	402
9.2 Аутоматско искључивање.....	391	14. СТРУКТУРА МЕНИЈА.....	403
9.3 Вентилатор за хлађење.....	391	14.1 Мени.....	403
10. КОРИСНИ САВЕТИ.....	391		
10.1 Влажно печење уз вентилатор.....	391		

1. ⚠ ИНФОРМАЦИЈЕ О БЕЗБЕДНОСТИ

Пре инсталације и коришћења уређаја, пажљиво прочитајте приложено упутство. Произвођач није одговоран за било какве повреде или штету које су резултат неисправне инсталације или употребе. Чувајте упутство за употребу на безбедном и приступачном месту за будуће коришћење.

1.1 Безбедност деце и осетљивих особа

- Овај уређај могу да користе деца старија од 8 година и особе са смањеним физичким, чулним или менталним способностима, као и особе којима недостају искуство и

знање, уколико им се обезбеди надзор или им се дају упутства у вези са употребом уређаја на безбедан начин и уколико схватају могуће опасности. Децу млађа од 8 година, као и особе са веома тешким и сложеним инвалидитетом, треба држати даље од уређаја, осим ако су под сталним надзором.

- Децу треба контролисати како се не би играла са уређајем.
- Држите сву амбалажу даље од деце и одложите је на одговарајући начин.
- УПОЗОРЕЊЕ: Постарајте се да деца и кућни љубимци не буду близу уређаја док уређај ради или се расхлађује. Доступни делови постају врели током употребе.
- Ако овај апарат има уређај за безбедност деце, треба га активирати.
- Деца не смеју да обављају чишћење и корисничко одржавање уређаја без надзора.

1.2 Опште мере безбедности

- Само квалификована особа може да монтира овај уређај и замени кабл.
- Не користите овај уређај пре него што га уградите.
- Искључите уређај из струје пре било каквог одржавања.
- Уколико је кабл за напајање оштећен, њега мора да замени произвођач, одговарајући Овлашћени сервисни центар или лица сличне квалификације, како би се избегла опасност од електрицитета.
- УПОЗОРЕЊЕ: Уверите се да је уређај искључен пре него што замените сијалицу како бисте избегли могућност да дође до електричног шока.
- УПОЗОРЕЊЕ: Уређај и његови доступни делови могу бити врели током коришћења. Треба бити пажљив како би се избегло додиривање грејних елемената.

БЕЗБЕДНОСНА УПУТСТВА

- Увек користите заштитне рукавице кад вадите прибор или посуђе из рерне или их стављате у рерну.
- Да бисте уклонили шине за подршку решетке прво повуците предњи део шина за подршку а затим задњи део од бочних зидова. Постављање шина за подршку решетке врши се обрнутим редоследом.
- Немојте користити парочистач за чишћење уређаја.
- Немојте користити груба абразивна средства за чишћење или оштре металне сунђере за чишћење стаклених врата јер они могу изгребати површину због чега може доћи до распрскавања стакла.
- Пре пиролитичког чишћења морате уклонити вишак просуте хране. Уклоните све делове из рерне.

2. БЕЗБЕДНОСНА УПУТСТВА

2.1 Монтажа



УПОЗОРЕЊЕ!

Само квалификована особа може да инсталира овај уређај.

- Уклоните комплетну амбалажу.
- Немојте да инсталирате или користите оштећен уређај.
- Придржавајте се упутстава за монтажање које сте добили уз уређај.
- Увек водите рачуна приликом померања уређаја зато што је тежак. Увек користите заштитне рукавице и затворену обућу.
- Не вуците уређај за ручицу.
- Инсталирајте уређај на сигурно и прикладно место које испуњава захтеве за инсталацију.
- Неопходно је придржавати се минималног растојања од других уређаја и кухињских елемената.
- Пре монтаже уређаја, проверите да ли се врата пећнице отварају без задршке.
- Овај уређај је опремљен системом за електрично хлађење. Мора се употребљавати са извором електричног напајања.
- Уграђена јединица мора да задовољи захтеве стабилности према DIN 68930.

Минимална висина кухињског елемента (минимална висина елемента испод радне плоче)	578 (600) мм
Ширина кухињског елемента	560 мм
Дубина кухињског елемента	550 (550) мм

Висина предње стране уређаја	594 мм
Висина задње стране уређаја	576 мм
Ширина предње стране уређаја	595 мм
Ширина задње стране уређаја	559 мм
Дубина уређаја	567 мм
Дубина уграђеног уређаја	546 мм
Дубина са отвореним вратима	1027 мм
Минимална величина вентилационог отвора. Отвор постављен на доњој задњој страни	560 x 20 мм
Дужина кабла за напајање. Кабл је постављен у десном углу са задње стране	1500 мм
Монтажни завртњи	4 x 25 мм

2.2 Прикључење на електричну мрежу



УПОЗОРЕЊЕ!

Ризик од пожара и струјног удара.

- Сва прикључивања струје треба да обави квалификован електричар.
- Уређај мора да буде уземљен.
- Уверите се да су параметри на плочици са техничким карактеристикама компатибилни са одговарајућим параметрима електричне мреже за напајање.
- Увек користите прописно уграђену утичницу са заштитом од струјног удара.
- Немојте да користите адаптере са више утичница и продужне каблове.
- Проверите да нисте оштетили главно напајање и кабл за напајање. Уколико струјни кабл треба да се замени, то треба да обави наш овлашћени сервисни центар.
- Не дозволите да кабл за напајање додирује или дође близу вратима уређаја или ниши испод уређаја, нарочито када уређај ради или када су врата врела.
- Заштита од удара делова под напоном и изолованих делова мора да се причврсти тако да не може да се уклони без алата.
- Прикључите главни кабл за напајање на зидну утичницу тек на крају инсталације. Водите рачуна да постоји приступ мрежном утикачу након инсталације.
- Ако је зидна утичница лабава, немојте да прикључујете мрежни утикач.
- Не вуците кабл за напајање како бисте искључили уређај. Кабл искључите тако што ћете извући утикач из утичнице.
- Користите само исправне раставне прекидаче: заштитне прекидаче, осигураче (осигураче са навојем треба скинути са носача), аутоматске заштитне прекидаче и контакторе.

- У електричној инсталацији мора постојати раставни прекидач који вам омогућава да искључите све фазе напајања уређаја. Размак између контаката на раставном прекидачу мора да износи најмање 3 mm.
- Потпуно затворите врата на уређају пре него што повежете мрежни утикач у зидну утичницу.
- Уређај се испоручује са струјним утикачем и струјним каблом.

2.3 Употреба



УПОЗОРЕЊЕ!

Постоји ризик од повређивања, опекотина и струјног удара или експлозије.

- Овај уређај је намењен само за кућну употребу (у затвореном простору).
- Немојте да мењате спецификацију овог уређаја.
- Водите рачуна да отвори за вентилацију не буду запушени.
- Не остављајте уређај без надзора током рада.
- Уређај треба искључити након сваке употребе.
- Будите опрезни кад отварате врата уређаја док он ради. Може се десити да изађе врео ваздух.
- Немојте руковати уређајем када су вам мокре руке или када је он у контакту са водом.
- Немојте излагати отворена врата великом оптерећењу.
- Немојте користити уређај као радну површину или простор за одлагање.
- Пажљиво отворите врата уређаја. Коришћење састојака који садрже алкохол може довести до испаравања алкохола и мешања са ваздухом.
- Варице или отворени пламен не смеју да буду у близини уређаја када отварате врата.
- Запаљиве материје или предмете натопљене запаљивим материјама немојте стављати унутар и поред уређаја или на њега.



УПОЗОРЕЊЕ!

Постоји ризик од оштећења уређаја.

- Да бисте спречили оштећење или губитак боје на емајлираним површинама:
 - Немојте стављати посуђе из рерне или друге предмете у уређају директно на дно.
 - Не стављајте алуминијумску фолију директно на дно унутрашњости уређаја.
 - Немојте сипати воду директно у врућ уређај.
 - Немојте држати у уређају влажно посуђе и храну након завршетка кувања.
 - Будите пажљиви када скидате или постављате прибор.
- Губитак боје на емајлираним површинама или нерђајућем челику не утиче на сам рад уређаја.
- Користите дубоки плех за заливане колаче. Воћни сок може да остави трајне мрље.
- Овај уређај је намењен само за кување. Немојте га користити у друге сврхе, на пример за загревање просторије.
- Док спремате јело, врата рерне треба увек да буду затворена.
- Ако је уређај монтиран иза панела намештаја (нпр. врата), обезбедите да приликом рада врата никада не буду затворена. Иза затвореног панела намештаја могу да се накупе топлота и влага и проузрокују накнадно оштећење уређаја, кућишта или пода. Не затварајте панел намештаја све док се уређај у потпуности не охлади након коришћења.

2.4 Нега и чишћење



УПОЗОРЕЊЕ!

Постоји ризик од озлеђивања, пожара или оштећења уређаја.

- Пре чишћења искључите уређај и извуците утикач из зидне утичнице.
- Проверите да ли је уређај хладан. Постоји ризик да се сломају стаклене плоче.
- Одмах замените стаклене плоче на вратима ако се оштете. Обратите се Овлашћеном сервисном центру.
- Будите пажљиви када скидате врата са уређаја. Врата су тешка!
- Редовно чистите уређај да бисте спречили пропадање површинског материјала.
- Уређај чистите влажном меком крпом. Користите искључиво неутралне детерџенте. Немојте користити абразивне производе, абразивне јастучиће за чишћење, раствараче или металне предмете.
- Уколико користите спреј за рерну, придржавајте се упутстава о безбедности на амбалажи.

2.5 Пиролитичко чишћење



УПОЗОРЕЊЕ!

Ризик од повреде/пожара/хемијске емисије (гасова) у пиролитичком режиму.

- Пре обављања функције пиролитичког самочишћења или пре прве употребе, из унутрашњости рерне уклоните:
 - Било какве остатке хране, уље или масноће које су просуте/наталожене.
 - Све предмете које је могуће уклонити (укључујући полице, бочне шине итд., испоручене с производом) нарочито посуде, плехове, тацне, прибор, итд. које имају нелепљиве површине.
- Пажљиво прочитајте сва упутства за пиролитичко чишћење.
- Држите децу подаље од уређаја док ради пиролитичко чишћење. Уређај постаје врео и врео ваздух се ослобађа из предњих отвора за хлађење.
- Операција пиролитичког чишћења одвија се на високој температури, због чега може доћи до ослобађања испарења насталих од остатака хране и материјала од којих је уређај направљен, те вам стога препоручујемо следеће:
 - Обезбедите добру вентилацију током и након сваког пиролитичког чишћења.
 - Обезбедите добру вентилацију у току и након прве употребе на максималној радној температури.
- За разлику од људи, неке птице и гмизавци могу бити изузетно осетљиви на потенцијална испарења која се емитују у току процеса чишћења свих пиролитичких рерни.
 - Склоните све кућне љубимце (посебно птице) који се налазе у близини уређаја током и након пиролитичког чишћења и прво подесите максималну температуру у добро проветреном простору.
- Мали кућни љубимци такође могу бити осетљиви на локалне промене температуре у близини пиролитичких рерни када је програм самочишћења пиролитичким у току.
- Нелепљиве површине посуда, плехова, тацни, прибора, итд. могу оштетити високе температуре поступка пиролитичког чишћења у свим рернама са пиролитичким у току.
- Испарења која генеришу све пиролитичке рерне/остаје кувања описани су као безбедни за људе, укључујући децу или лица са здравственим проблемима.

2.6 Унутрашње осветљење



УПОЗОРЕЊЕ!

Ризик од струјног удара.

- Када се ради о сијалицама унутар производа и резервних делова, сијалице које се продају засебно: Ове сијалице су намењене да издрже екстремне физичке услове у кућним апаратима, као што су температура, вибрације, влага, или су намењене да сигнализирају информације о радном стању уређаја. Нису предвиђене за употребу у другим уређајима и нису погодне за осветљавање просторија у домаћинству.
- Користите само сијалице које имају исту спецификацију.

2.7 Услуга

- Ради оправке уређаја обратите се овлашћеном сервисном центру..
- Користите само оригиналне резервне делове.

2.8 Одлагање



УПОЗОРЕЊЕ!

Ризик од повреде или гушења.

- Искључите утикач кабла за напајање уређаја из мрежне утичнице.
- Исеците мрежни електрични кабл на месту које је близу уређаја и одложите га.
- Уклоните ручицу од врата да бисте спречили да се деца или кућни љубимци заглаве у уређају.

3. ОПИС ПРОИЗВОДА

3.1 Општи приказ

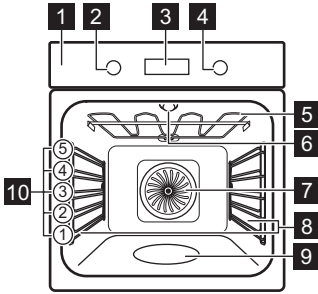

- 1** Командна табла
- 2** Командно дугме за функције загревања
- 3** Дисплеј
- 4** Командно дугме
- 5** Грејни елемент
- 6** Лампа
- 7** Вентилатор
- 8** Носач решетке, покретни
- 9** Положаји решетке
- 10** Утиснути делови унутрашњости

3.2 Прибор

Решеткаста полица

За посуђе за кување, калупе за колаче, печење.

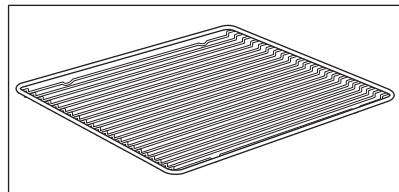

Плех за печење

За колаче и кексе.

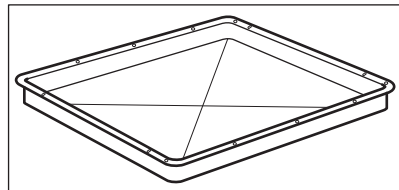

КАКО СЕ УКЉУЧУЈЕ И ИСКЉУЧУЈЕ РЕРНА

Грил/дубоки тигањ

За печење теста и меса или као посуда за скупљање масноће.

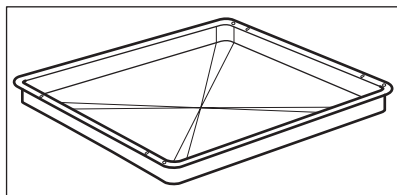

Телескопске вођице

За лакше убацивање и вађење плехова и решеткастих полица.

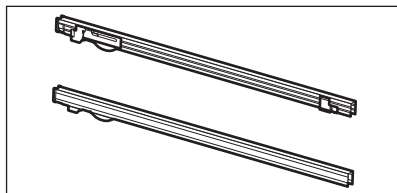







4. КАКО СЕ УКЉУЧУЈЕ И ИСКЉУЧУЈЕ РЕРНА

4.1 Дугмад која се увлаче

За коришћење овог уређаја притисните командно дугме. Командно дугме се извлачи.

4.2 Командна табла

Сензорска поља командне табле					Притискајте дугме	Окрените командно дугме
 Тајмер	 Брзо загревање	 Светло	 Контролна бртва	ОК		







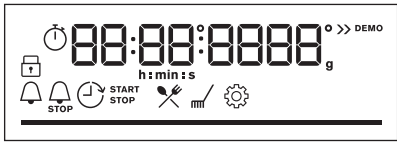

Изаберите функцију загревања да бисте уључили пећницу.

Окрените командно дугме за функције загревања у положај „искључено“ да бисте искључили пећницу.

	Када је командно дугме за функције загревања буде у положају „искључено“, дисплеј прелази у режим приправности.
---	---

	<p>Када кувате, на дисплеју се приказује подешена температура, доба дана и друге доступне опције.</p>
	<p>Дисплеј са максималним бројем подешених функција.</p>

Индикатори дисплеја

 Контролна бртва	 Потпомогнута припрема	 Чишћење	 Подешавања	 Брзо загревање
Индикатори времена:				



<p>Трака напретка – за температуру или време.</p>	
---	---

<p>Индикатор за куваче на пари</p>	
------------------------------------	---

5. ПРЕ ПРВЕ УПОТРЕБЕ

 <p>УПОЗОРЕЊЕ! Погледајте поглавља о безбедности.</p>
--

5.1 Прво чишћење

<p>Пре прве употребе, очистите празну пећницу и подесите време:</p>			
			 00:00 Подесите тајмер. Притисните OK .

СВАКОДНЕВНА УПОТРЕБА

5.2 Иницијално предгревање



Претходно загрејте рерну пре прве употребе.

Корак 1 Уклоните сав прибор и подршке решетки из рерне.

Корак 2 Подесите максималну температуру за функцију: .
Оставите рерну да ради 1 сат.

Корак 3 Подесите максималну температуру за функцију: .
Оставите рерну да ради 15 минута.

Рерна може да испушта мирис и дим током предгревања. Уверите се да је просторија проветрена.

6. СВАКОДНЕВНА УПОТРЕБА



УПОЗОРЕЊЕ!

Погледајте поглавља о безбедности.

6.1 Како да подесите: Функције загревања

Почните да кувате

Корак 1



Подесите функцију загревања.

Корак 2



Подесите температуру.

Кување на пари

Проверите да ли је пећница хладна.

Корак 1

Корак 2

Корак 3



Корак 4









Кување на пари			
			Загрејте празну пећницу током 10 мин да би се створила влага. Ставите храну у пећницу.
Испуните удубљења у унутрашњости водом са чесме.	Подесите функцију загревања на пари.	Подесите температуру.	
<p>i Максимални капацитет удубљења у унутрашњости рерне је 250 ml. Немојте да допуњавате удубљења у унутрашњости током кувања или када је пећница врућа.</p>			

Када се кување на пари заврши:		
Корак 1	Корак 2	Корак 3
Окрените командно дугме за функције загревања у положај „искључено“ да бисте искључили пећницу.	Пажљиво отворите врата. Отпуштена влага може да изазове опекотине.	Проверите да ли је пећница хладна. Уклоните преосталу воду из удубљења у унутрашњости.

6.2 Функције загревања

Стандардне функције загревања

Функција загревања	Примена
 <p>Печење уз равни вентил.</p>	За печење на највише три положаја решетке истовремено и за сушење хране. Подесите температуру да буде нижа за 20–40°C него за Загrev. одозго/одоздо.
 <p>Загrev. одозго/одоздо</p>	За печење на једном положају решетке.

Функција загревања	Примена
 SteamBake	За додавање влаге током кувања. За добијање праве боје и хрскаве корице током печења. За већу сочност при поновном загревању. За очување воћа или поврћа.
 Функција за пицу	За печење пице. За интензивно запецање и добијање хрскавог дна.
 Загревање одоздо	За печење колача са хрскавим дном и за конзервисање хране.
 Смрзнута храна	За припрему полуспремљене хране (нпр. помфрита, исеченог кромпира или пролећних ролница), тако да буде хрскава.
 Влажно печење уз вентилатор	Ова функција је предвиђена за уштеду енергије током кувања. Када користите ову функцију, температура унутар рерне може да се разликује од задате температуре. Користи се заостала топлота. Снага загревања може бити умањена. За више информација погледајте поглавље „Свакодневна употреба“, напомене у вези са: Влажно печење уз вентилатор.
 Гриловање	За гриловање танких комада хране и тостирање хлеба.
 Турбо гриловање	За печење великих комада меса или живине са костима на једној решетки. За спремање гратинираних јела и за запецање.
 Мени	Да бисте ушли у Мени: Потпомогнута припрема, Чишћење, Подешавања.

6.3 Напомене у вези са: Влажно печење уз вентилатор





Ова функција је коришћена за усклађивање са класом енергетске ефикасности и захтевима екодизајна у складу са стандардима EU 65/2014 и EU 66/2014. Тестови према стандарду EN 60350-1.

Врата пећнице треба да буду затворена током кувања како функција не би била прекидана и како би пећница радила на највишем могућем степену енергетске ефикасности.



Када користите ову функцију, лампица се аутоматски искључује након 30 сек. За упутства за кување погледајте одељак „Напомене и савети”, Влажно печење уз вентилатор. За опште препоруке у вези са уштедом енергије погледајте одељак „Енергетска ефикасност”, Уштеда енергије.

6.4 Како да подесите: Потпомогнута припрема

Свако јело у овом подменију има препоручену функцију и температуру. Можете да подесите време и температуру током кувања.

Потпомогнута припрема – користите за брзу припрему јела са подразумеваним подешавањима:			
Корак 1	Корак 2	Корак 3	Корак 4
			
Уђите у мени.	Изаберите Потпомогнута припрема. Притисните ОК.	Изаберите јело. Притисните ОК.	Ставите посуду у пећницу. Потврдите подешавање.





6.5 Потпомогнута припрема са рецептима

Легенда	
	Количина воде за функцију на пари.
	Загрејте пећницу пре кувања.
	Ниво решетке.







Када се функција заврши, проверите да ли је храна спремна.

Јело	Тежина	Ниво решетке/Прибор	Време трајања
Говедина 			











СВАКОДНЕВНА УПОТРЕБА

	Јело	Тежина	Ниво решетке/Прибор	Време трајања
P1	Говеђе печење, слабо печено	1–1,5 кг; комади дебљине 4–5 цм	 2; плех за печење Пржите месо неколико минута на врућем тигању. Ставите у пећницу.	40 мин
P2	Говеђе печење, средње печено			50 мин
P3	Говеђе печење, добро печено			60 мин
P4	Котлет, средње печен	180–220 г по комаду; комади дебљине 3 цм	  3; посуда за печење на решеткастој полици Пржите месо неколико минута на врућем тигању. Ставите у пећницу.	15 мин
P5	Говеђе печење/динстано (ребра прве класе, округли одрезак, дебели пауфлек)	1,5–2 кг	 2; посуда за печење на решеткастој полици Пржите месо неколико минута на врућем тигању. Додајте течност. Ставите у пећницу.	120 мин
P6	Говеђе печење, слабо печено (споро печење)	1–1,5 кг; комади дебљине 4–5 цм	 2; плех за печење Користите своје омиљене зачине или једноставно со и свежу млевену паприку. Пржите месо неколико минута на врућем тигању. Ставите у пећницу.	75 мин
P7	Говеђе печење, средње печено (споро печење)			85 мин
P8	Говеђе печење, добро печено (споро печење)			130 мин

















СВАКОДНЕВНА УПОТРЕБА

	Јело	Тежина	Ниво решетке/Прибор	Време трајања
P9	Филе, слабо печено (споро печење)	0,5–1,5 кг; комади дебљине 5–6 цм	 2; плех за печење Користите своје омиљене зачине или једноставно со и свежу млевену паприку. Пржите месо неколико минута на врућем тигању. Ставите у пећницу.	75 мин
P10	Филе, средње печен (споро печење)			90 мин
P11	Филе, печен (споро печење)			120 мин
Телетина 				
P12	Печена телетина (нпр. плећка)	0,8–1,5 кг; комади дебљине 4 цм	 2; посуда за печење на решеткастој полици Користите омиљене зачине. Додајте течност. Печење покривено.	80 мин
Свињетина 				
P13	Свињско печење, врат или плећка	1,5–2 кг	 2; посуда за печење на решеткастој полици Окрените месо након половине времена кувања.	120 мин
P14	Вучена свињетина ЛТЦ	1,5–2 кг	 2; плех за печење Користите омиљене зачине. Окрените месо након половине времена кувања да бисте постигли равномерно запецање.	215 мин
P15	Каре, свез	1–1,5 кг; комади дебљине 5–6 цм	 2; посуда за печење на решеткастој полици Користите омиљене зачине.	55 мин



















СВАКОДНЕВНА УПОТРЕБА















	Јело	Тежина	Ниво решетке/Прибор	Време трајања
P16	Ребра	2–3 кг; користите сирову, танка ребра дебљине 2–3 цм	 3; дубоки тигањ Додајте течност да бисте покрили дно посуде. Окрените месо након половине времена кувања.	90 мин
Јагњетина 				
P17	Јагњећи бут са костима	1,5–2 кг; комади дебљине 7–9 цм	 2; посуда за печење на плеху за печење Додајте течност. Окрените месо након половине времена кувања.	130 мин
Живина 				
P18	Цело пиле	1–1,5 кг; свеже	 2;  200 ml; посуда за касеролу на плеху за печење Користите омиљене зачине. Окрените пиле након половине времена кувања да бисте постигли равномерно запецање.	60 мин
P19	Пола пилета	0,5–0,8 кг	 3; плех за печење Користите омиљене зачине.	40 мин
P20	Пилеће груди	180–200 г по комаду	  2; посуда за касеролу на решеткастој полици Користите омиљене зачине. Пржите месо неколико минута на врућем тигању.	25 мин
P21	Пилећи батаци, свежи	-	 3; плех за печење Ако сте прво маринирали пилеће батаке, подесите нижу температуру и кувајте их дуже.	30 мин

СВАКОДНЕВНА УПОТРЕБА

	Јело	Тежина	Ниво решетке/Прибор	Време трајања
P22	Патка, цела	2–3 кг	 2; посуда за печење на решеткастој полици Користите омиљене зачине. Ставите месо на посуду за печење. Окрените патку након половине времена кувања.	100 мин
P23	Гуска, цела	4–5 кг	 2; дубоки тигањ Користите омиљене зачине. Ставите месо на дубоки плех за печење. Окрените гуску након половине времена кувања.	110 мин
Остало 				
P24	Векна од меса	1 кг	 2; решеткаста полица Користите омиљене зачине.	60 мин
 Риба				
P25	Цела риба, грилована	0,5–1 кг по риби	 2 ; плех за печење Испуните рибу маслацем и користите омиљене зачине и зачинско биље.	30 мин
P26	Рибљи филети	-	  3; посуда за касеролу на решеткастој полици Користите омиљене зачине.	20 мин
Печење слаткиша/десерти   				
P27	Колач од сира	-	 2;  калупа за печење од 28 цм на решеткастој полици	90 мин
P28	Колач од јабука	-	 2;  100–150 ml; плех за печење	60 мин
P29	Тарт од јабука	-	 2; калуп за питу на решеткастој полици	40 мин



СВАКОДНЕВНА УПОТРЕБА

	Јело	Тежина	Ниво решетке/Прибор	Време трајања
P30	Пита с јабукама	-	 2;  100–150 ml;  калуп за питу од 22 цм на решеткастој полици	60 мин
P31	Брауни колачи	2 кг	 3; дубоки тигањ	30 мин
P32	Чоколадни мафини	-	 2;  100–150 ml; плех за мафине на решеткастој полици	30 мин
P33	Суви колач	-	 2; посуда за колач на решеткастој полици	50 мин
Поврће/Прилози   				
P34	Печени кромпир	1 кг	 2; плех за печење Ставите цео кромпир са кором на плех за печење.	50 мин
P35	Домаћински кромпир	1 кг	 3; плех за печење обложен папиром за печење Користите омиљене зачине. Исеците кромпире на комаде.	35 мин
P36	Гриловано мешано поврће	1–1,5 кг	 3; плех за печење обложен папиром за печење Користите омиљене зачине. Исеците поврће на комаде.	30 мин
P37	Крокети, замрзнати	0,5 кг	 3; плех за печење	25 мин
P38	Помфрит, замрзнат	0,75 кг	 3; плех за печење	25 мин
Гратинирана јела, леб и пица   				
P39	Лазање/Касероле од кнедли	1–1,5 кг	 2; посуда за касеролу на решеткастој полици	45 мин

	Јело	Тежина	Ниво решетке/Прибор	Време трајања
P40	Гратинирани кромпир	1–1,5 кг	 1; посуда за касеролу на решеткастој полици	50 мин
P41	Свежа пица, танка	-	  2;  100 ml; плех за печење обложен папиром за печење	15 мин
P42	Свежа пица, дебела	-	  2;  100 ml; плех за печење обложен папиром за печење	25 мин
P43	Киш	-	 2; плех за печење на решеткастој полици	45 мин
P44	Багет/Ћабата/Бели хлеб	0,8 кг	  3;  150 ml; плех за печење обложен папиром за печење За бели хлеб је потребно више времена.	30 мин
P45	Хлеб са целим зрном/ ражени хлеб/ црни хлеб са целим зрном у посуди за хелб	1 кг	  2;  150 ml; плех за печење обложен папиром за печење/ решеткаста полица	45 мин

7. ФУНКЦИЈЕ САТА

7.1 Функције сата

Функција сата	Примена
	Тајмер. Када тајмер заврши са одбројавањем, оглашава се звучни сигнал.
	Време кувања. Када тајмер заврши са одбројавањем, чује се звучни сигнал и функција загревања се зауставља.
	Време одлагања. За одлагање старта и/или краја кувања.

ФУНКЦИЈЕ САТА

Функција сата	Примена
	Тајмер током рада. Максимално је 23 ч 59 мин. Ова функција не утиче на рад пећице. За укључивање и искључивање Тајмер током рада изаберите: Мени, Подешавања.

7.2 Како да подесите: Функције сата

Како да подесите: Доба дана		
Корак 1	Корак 2	Корак 3
		
Да бисте променили доба дана, уђите у мени и изаберите опције Подешавања, Доба дана.	Подесите сат.	Притисните: ОК.

Како да подесите: Тајмер			
Корак 1	Дисплеј приказује: 0:00 	Корак 2	Корак 3
			
Притисните:  .		Подесите Тајмер	Притисните: ОК.
 Тајмер одмах почиње да одбројава.			

КАКО ДА КОРИСТИТЕ: ПРИБОР

Како да подесите: Време кувања

Корак 1	Корак 2	Дисплеј приказује: 0:00  STOP	Корак 3	Корак 4
				
Изаберите функцију загревања и подесите температуру.	Узастопно притискајте:  .	За подешавање времена кувања.	Притисните: ОК .	

 Тајмер одмах почиње да одбројава.

Како да подесите: Време одлагања

Корак 1	Корак 2	Дисплеј приказује: доба дана  ПО-КРЕТАЊЕ	Корак 3	Корак 4	Дисплеј приказује: --:--  ЗАУСТАВЉАЊЕ	Корак 5	Корак 6
							
Изаберите функцију загревања.	Узастопно притискајте:  .	Подесите време почетка.	Притисните: ОК .	Подесите време завршетка.	Притисните: ОК .		

 Тајмер почиње да одбројава у подешено време почетка.

8. КАКО ДА КОРИСТИТЕ: ПРИБОР

8.1 Убацивање прибора

Мало удубљење са горње стране повећава безбедност. Удубљења такође спречавају превртање. Уздигнута ивица око полице спречава клизање посуђа на полици.

ДОДАТНЕ ФУНКЦИЈЕ

Решеткаста полица:

Угурајте полицу између вођица на носачу решетке .

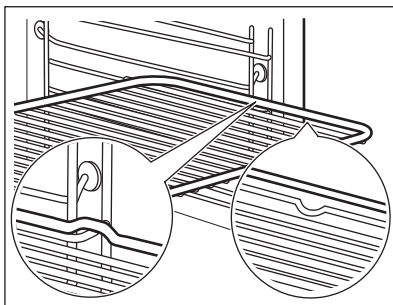

Плех за печење /Дубоки тигањ:

Угурајте плех између вођица на подршци решетке.

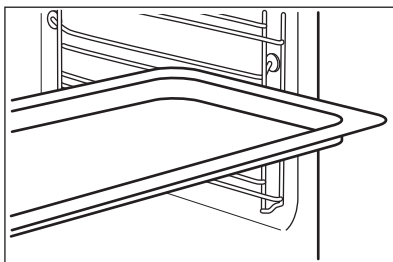

Решеткаста полица, Плех за печење / Дубоки тигањ:

Гурните плех између вођица на подршци за решетке и решеткасту полицу између вођица на подршци за решетке изнад.

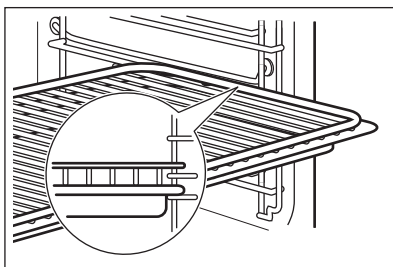

9. ДОДАТНЕ ФУНКЦИЈЕ

9.1 Контролна брава

Ова функција спречава случајну промену функције пећнице.

Укључите је када пећница ради – подешено кување се наставља, командна табла је закључана.



Укључите је када је пећница искључена – пећница не може да се укључи, командна табла је закључана.

Ова функција спречава случајну промену функције пећнице.





 – притисните и држите да бисте укључили функцију.
Звучни сигнал.

 – притисните и држите да бисте је искључили.

 3 x  – трепери када је контролна брава укључена.

9.2 Аутоматско искључивање

Из безбедносних разлога пећница се искључује након неког времена ако функција загревања ради, а ви не промените подешавања.

 (°C)	 (h)
30 - 115	12.5
120 - 195	8.5
200 - 245	5.5
250 - максимално	3

Аутоматско искључивање не ради са функцијама: Светло, Време одлагања.

9.3 Вентилатор за хлађење

Док рерна ради, вентилатор за хлађење се аутоматски укључује у циљу хлађења спољних површина рерне. Ако искључите рерну, вентилатор за хлађење може наставити да ради све док се рерна не охлади.

10. КОРИСНИ САВЕТИ

10.1 Влажно печење уз вентилатор

За постизање најбољих резултата, придржавајте се савета наведених у табели у наставку.

Користите трећи ниво решетке.

КОРИСНИ САВЕТИ

	 (°C)	 (min)
Гратинирана тестенина	200 - 220	45 - 55
Гратинирани кромпир	180 - 200	70 - 85
Мусака	170 - 190	70 - 95
Лазање	180 - 200	75 - 90
Канелони	180 - 200	70 - 85
Пудинг од хлеба	190 - 200	55 - 70
Пудинг од пиринча	170 - 190	45 - 60
Колач с јабукама, направљен од смесе за бисквит тарту (округли плех за тарту)	160 - 170	70 - 80
Бели хлеб	190 - 200	55 - 70

10.2 Влажно печење уз вентилатор - препоручени прибор

Користите тамне и нерелефтујуће лименке и посуде. Оне бољу апсорбују топлоту него светле боје и рефлектујуће посуде.

			
Плех за пизу	Посуда за печење	Мала посуда за печење	Плех за флан
Таман, нерелефтујући Пречник 28 см	Таман, нерелефтујући Пречник 26 см	Керамички Пречник 8 см, висина 5 см	Таман, нерелефтујући Пречник 28 см





10.3 Табеле кувања за институте за тестирање

Информације за институте за тестирање

Тестови у складу са: EN 60350, IEC 60350.



ПЕЧЕЊЕ НА ЈЕДНОМ НИВОУ. Печење у плеховима





		 (°C)	 (min)	
Немасна бисквит торта	Печење уз равни вентил.	140 - 150	35 - 50	2
Немасна бисквит торта	Загрев. одозго/ одоздо	160	35 - 50	2
Пита с јабукама, 2 плеха Ø20 cm	Печење уз равни вентил.	160	60 - 90	2
Пита с јабукама, 2 плеха Ø20 cm	Загрев. одозго/ одоздо	180	70 - 90	1



ПЕЧЕЊЕ НА ЈЕДНОМ НИВОУ. Кекс



Користите трећи ниво решетке.

		 (°C)	 (min)
Шкотски колачић / Пециво у облику трачица	Печење уз равни вентил.	140	25 - 40
Шкотски колачић / Пециво у облику трачица, претходно загрејте празну рерну	Загрев. одозго/одоздо	160	20 - 30
Ситни колачи, 20 по плеху, претходно загрејте празну рерну	Печење уз равни вентил.	150	20 - 35
Ситни колачи, 20 по плеху, претходно загрејте празну рерну	Загрев. одозго/одоздо	170	20 - 30

НЕГА И ЧИШЋЕЊЕ



ПЕЧЕЊЕ НА ВИШЕ НИВОА. Кекс

		 (°C)	 (min)	
Шкотски колачић / Пециво у облику трачица	Печење уз равни вентил.	140	25 - 45	1 / 4
Ситни колачи, 20 по плеху, претходно загрејте празну рерну	Печење уз равни вентил.	150	23 - 40	1 / 4
Немасна бисквит торта	Печење уз равни вентил.	160	35 - 50	1 / 4



ГРИЛ



Претходно загрејте празну рерну у трајању од 5 минута.



Када печете на грилу, температура мора да буде подешена на максимум.

		 (min)	
Тост	Гриловање	1 - 3	5
Говеђи котлет, окрените када истекне половина времена	Гриловање	24 - 30	4



11. НЕГА И ЧИШЋЕЊЕ



УПОЗОРЕЊЕ!

Погледајте поглавља о безбедности.

11.1 Напомене у вези са чишћењем

 <p>Средства за чишћење</p>	Обришите предњу страну рерне меком крпом, топлом водом и благим средством за чишћење.
	За чишћење металних површина користите раствор средства за чишћење.
	Очистите мрље благим детерџентом.
 <p>Свакодневна употреба</p>	Очистите унутрашњост рерне након сваке употребе. Нагомилана масноћа или други остаци могу проузроковати пожар.
	Не одлажите храну у рерни дуже од 20 минута. Након сваке употребе, осушите унутрашњост меком крпом.
 <p>Прибор</p>	Након сваке употребе, очистите сав пибор и оставите га да се осуши. Користите меку крпу са топлом водом и благим детерџентом. Немојте прати прибор у машини за прање судова.
	Не чистите прибор са нелепљивим премазом помоћу абразивних средстава за чишћење или предмета са оштрим ивицама.

11.2 Како да очистите: Удубљења у унутрашњости

Очистите удубљења у унутрашњости да бисте уклонили преостале наслаге каменца након кувања на пари.

Корак 1	Корак 2	Корак 3
Сипајте: 250 ml белог сирћета у удубљење у унутрашњости. Користите раствор од 6% сирћета без икаквих додатака.	Оставите да сирће раствори наслаге каменца на температури просторије у трајању од 30 минута.	Очистите унутрашњост топлем водом и меком крпом.
За функцију: SteamWake чистите пећницу на сваких 5–10 циклуса кувања.		

11.3 Како да извадите: Подршке за решетке

Извадите подршке решетака да бисте очистили рерну.

НЕГА И ЧИШЋЕЊЕ

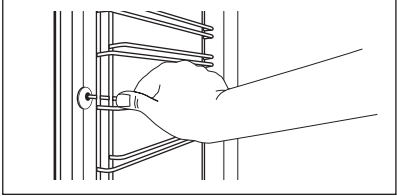
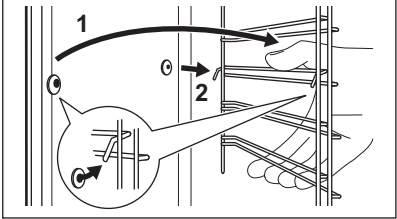
Корак 1	Искључите рерну и сачекајте да се охлади.	
Корак 2	Извуците предњи део подршке решетке из бочног зида.	
Корак 3	Извуците задњи део подршке решетке из бочног зида и уклоните га.	
Корак 4	Постављање шина за подршку решетке врши се обрнутим редоследом. Клинови на телескопским вођицама морају бити окренути ка предњој страни.	

11.4 Како да користите: Пиролитичко чишћење

Очистите печницу користећи Пиролитичко чишћење.



УПОЗОРЕЊЕ!

Постоји ризик од опекотина.



ОПРЕЗ



Ако су други уређаји инсталирани у исти кухињски елемент, не користите их истовремено кад и ову функцију. То може да изазове оштећење рерне.

Пре Пиролитичко чишћење:

Искључите рерну и сачекајте да се охлади.	Уклоните сав прибор и уклоните носаче решетке.	Очистите дно рерне и унутрашње стакло врата рерне топло водом и меком крпом.
---	--	--

Пиролитичко чишћење

Корак 1	Уђите у мени: Чишћење  .	
Опција	Трајање	
C1 - Благо чишћење	1 h	
C2 - Нормално чишћење	1 h 30 min	

Пиролитичко чишћење	
С3 - Темељно чишћење	3 h
Корак 2	ОК – притисните да изаберете програм чишћења.
Корак 3	ОК – притисните да покренете чишћење.
Корак 4	Након чишћења, окрените дугме функције загревања на положај „искључено”.
 За време чишћења, лампица у рерни је искључена.	
Кад рерна достигне подешену температуру, врата се закључавају. Док се врата не закључају, дисплеј приказује следеће:  .	

Када се чишћење заврши:		
Искључите рерну и сачекајте да се охлади.	Обришите унутрашњост меком крпом.	Уклоните остатке са дна рерне.

11.5 Подсетник за чишћење

Пећница вас подсећа када да је очистите помоћу пиролитичког чишћења.	
 трепери на дисплеју 5 сек након сваког интервала кувања.	Да бисте искључили подсетник, уђите у Мени и изаберите опције Подешавања, Подсетник за чишћење.

11.6 Како да скинете и монтирате: Врата

Врата и унутрашње стаклене плоче можете скинути да бисте их очистили Број стаклених плоча се разликује код различитих модела.

	УПОЗОРЕЊЕ! Врата су тешка.
--	--------------------------------------

	ОПРЕЗ Пажљиво рукујте стаклом, посебно око ивица предње плоче. Стакло може да се сломи.
--	---

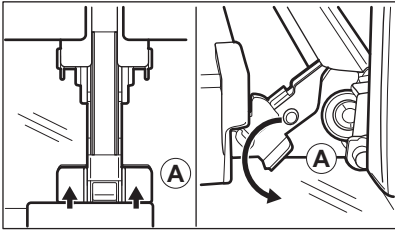
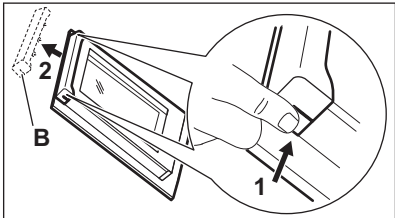
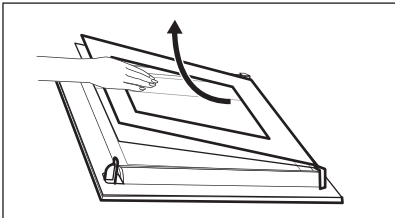
Корак 1	Отворите врата до краја.	
Корак 2	Подигните и притисните стезне полуке (A) на обема шаркама врата.	
Корак 3	Затворите врата рерне до првог положаја за отварање (приближно под углом од 70°). Придржите врата са обе стране и повуците их нагоре у односу на рерну како бисте их одвојили. Врата поставите на меку крпу на стабилној површини са спољном страном окренутом надоле.	
Корак 4	Притисните оквир врата (B) са обе стране горње ивице ка унутра да бисте отпустили стезну заптивку.	
Корак 5	Повуците оквир врата напред да бисте га уклонили.	
Корак 6	Ухватите стаклене плоче за горњу ивицу и једну по једну их извуците нагоре из вођице.	
Корак 7	Очистите стаклену плочу водом и сапуницом. Пажљиво осушите стаклену плочу. Не перите стаклене плоче у машини за прање судова.	
Корак 8	Након чишћења, горе описани поступак обавите супротним редоследом.	
Корак 9	Прво поставите мању плочу, а затим већу и врата. Уверите се да су стакла убачена у правилан положај, јер у супротном може доћи до прегревања површине врата.	

11.7 Како да замените: Лампица



УПОЗОРЕЊЕ!

Ризик од струјног удара.
Лампица може бити врућа.

Пре замене лампице:		
Корак 1	Корак 2	Корак 3
Искључите рерну. Сачекајте да се рерна охлади.	Искључите утикач кабла за напајање рерне из мрежне утичнице.	Дно унутрашњости рерне прекријте крпом.

Горња лампица

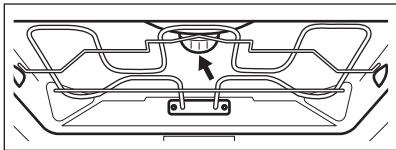
Корак 1	Окрените стаклени поклопац како бисте га скинули.	
Корак 2	Очистите стаклени поклопац.	
Корак 3	Замените лампицу одговарајућом лампицом која је отпорна на топлоту до 300 °C.	
Корак 4	Поставите стаклени поклопац.	

12. РЕШАВАЊЕ ПРОБЛЕМА



УПОЗОРЕЊЕ!

Погледајте поглавља о безбедности.

12.1 Шта учинити ако...

У свим случајевима који нису обухваћени овом табелом, контактирајте са овлашћеним сервисним центром.

 Рерна се не укључује или се не загрева	
Проблем	Проверите...
Не можете да активирате пећницу нити да њоме управљате.	Пећница је правилно прикључена на електрично напајање.
Пећница се не загрева.	Функција аутоматског искључивања је деактивирана.

РЕШАВАЊЕ ПРОБЛЕМА



Рерна се не укључује или се не загрева

Пећница се не загрева.	Врата пећнице су затворена.
Пећница се не загрева.	Осигурач није прегорео.
Пећница се не загрева.	Активирана је опција Блок. за безб. деце.



Компоненте

Проблем	Проверите...
Лампица је искључена.	Влажно печење уз вентилатор – је укључен.
Лампа не ради.	Лампица је прегорела.



Шифре грешке

Дисплеј приказује...	Проверите...
Err C3	Врата пећнице су затворена или закључавање врата није покварено.
Err F102	Врата пећнице су затворена.
Err F102	Закључавање врата није покварено.
00:00	Дошло је до нестанка струје. Подесите доба дана.

Ако се на дисплеју прикаже код грешке који није у овој табели, искључите и укључите кућни осигурач да бисте поново покренули пећницу. Ако се код грешке поново појави, обратите се овлашћеном сервисном центру.



Чишћење

Проблем	Проверите...
---------	--------------



Чишћење

Цурење воде из удубљења у унутрашњости.

У удубљењу у унутрашњости има превише воде.

12.2 Подаци о сервисирању

Уколико не можете сами да пронађете решење проблема, обратите се продавцу или овлашћеном сервисном центру.

Подаци потребни сервисном центру налазе се на плочици са техничким карактеристикама. Плочица са техничким карактеристикама налази се на предњој страни оквира унутрашњости рерне. Немојет уклањати плочицу са техничким карактеристикама из унутрашњости рерне.

Препоручујемо вам да овде запишете податке:

Модел (MOD.)

.....

Број производа (PNC)

.....

Серијски број (S.N.)

.....

13. ЕНЕРГЕТСКА ЕФИКАСНОСТ

13.1 Информације о производу и Лист са информацијама о производу*

Назив добављача	AEG
Идентификација модела	BPB351160M 944188506 BPS351160M 944188507
Индекс енергетске ефикасности	81.2
Класа енергетске ефикасности	A+
Потрошња енергије са стандардним пуњењем, уобичајен режим	1.09 kWh/циклусу
Потрошња енергије са стандардним пуњењем, режим са форсирањем вентилатора	0.69 kWh/циклусу
Број шупљина у рерни	1

Извор топлоте	Електрична струја	
Запремина	71 l	
Тип рерне	Уградна рерна	
Маса	BPB351160M	34.0 kg
	BPS351160M	34.0 kg

* За Европску унију у складу са прописима ЕУ 65/2014 и 66/2014.
 За Републику Белорусију у складу са СТБ 2478-2017, додаток G; СТБ 2477-2017, Анекси А и В.
 За Украјину у складу са 568/32020.

Класа енергетске ефикасности није применљива за Русију.

EN 60350-1 – Електрични уређаји за кување у домаћинству – део 1: Шпорети, рерне, рерне на пару и грилови – поступци за мерење учинка.

13.2 Уштеда енергије



Ова пећница има функције које вам помажу да уштедите енергију током свакодневног кувања.

Проверите да ли су врата пећнице затворена када пећница ради. Не отварајте врата пећнице сувише често током кувања. Одржавајте заптивку врата чистом и постарајте се да буде добро причвршћена на свом месту.

Користите метално посуђе за кување да бисте повећали уштеду енергије.

Кад је то могуће, немојте да загревате пећницу пре кувања.

Правите што краће размаке између печења када истовремено припремате неколико јела.

Кување са вентилатором

Када је могуће, користите функције кувања са вентилатором да бисте уштедели енергију.

Преостала топлота

Вентилатор и лампица настављају да раде. Када искључите пећницу, дисплеј приказује преосталу топлоту. Можете да користите ту топлоту како бисте храну одржали топлим.

Када је време печења дуже од 30 мин., смањите температуру пећнице на минимум, 3–10 минута пре истека краја кувања. Месо ће наставити да се пече користећи преосталу топлоту у рерни.

Користите преосталу топлоту за загревање друге хране.

Одржавање хране топлим

Изаберите најниже могуће подешавање температуре да бисте помоћу преостале топлоте одржали топлоту obroка. На дисплеју се приказује индикатор преостале топлоте или температура.

Кување са искљученом лампицом

Искључите лампицу током кувања. Укључите је само када вам је потребна.



Влажно печење уз вентилатор

Функција је предвиђена за уштеду енергије током кувања.



Када користите ову функцију, лампица се аутоматски искључује након 30 сек. Можете поново да упалите лампицу, али ће ова активност смањити очекивану уштеду енергије.

14. СТРУКТУРА МЕНИЈА

14.1 Мени

	 – изаберите за улаз у Мени.
---	---

Мени структура

Потпомогнута припрема 	Чишћење 	Подешавања 
---	---	--

Корак 1	Корак 2	Корак 3	Корак 4	Корак 5
 	 ОК	 01 – 011	 ОК	
Изаберите Мени, Подешавања.	Потврдите подешавање.	Изаберите подешавање.	Потврдите подешавање.	Прилагодите вредност и притисните ОК.



Подешавања

01	Доба дана	Промени	02	Осветљеност дисплеја	1 - 5
03	Звукови тастера	1 – Звучни сигнал 2 – Клик 3 – Звук је искључен	04	Јачина звучног сигнала	1 - 4
05	Тајмер током рада	Укључи/ Искључи	06	Светло	Укључи/ Искључи
07	Брзо загревање	Укључи/ Искључи	08	Подсетник за чишћење	Укључи/ Искључи

СТРУКТУРА МЕНИЈА

Подешавања					
О9	Демо режим	Активациони код: 2468	О10	Верзија софтвера	Провера
О11	Поништи сва подешавања	Да/Не			

15. ЕКОЛОШКА ПИТАЊА

Рециклирајте материјале са симболом . Паковање одложите у одговарајуће контејнере ради рециклирања. Помозите у заштити животне средине и људског здравља као и у рециклирању отпадног материјала од електронских и електричних уређаја. Уређаје обележене симболом  немојте бацати заједно са смећем. Производ вратите у локални центар за рециклирање или се обратите општинској канцеларији.

NA DOSIAHNUTIE PERFEKTNÝCH VÝSLEDKOV

Ďakujeme, že ste si vybrali tento výrobok značky AEG. Vytvorili sme ho, aby vám poskytol bezchybný výkon na mnoho rokov, pričom sme použili inovačné technológie, ktoré pomáhajú zjednodušovať život – funkcie, ktoré nenájdete u bežných spotrebičov. Venujte, prosím, niekoľko minút tomuto návodu a dôkladne si ho prečítajte, aby ste svoj spotrebič mohli využívať čo najlepšie.

Navštívte našu stránku, kde nájdete:



Rady týkajúce sa používania, brožúry, návody na riešenie problémov a informácie o servise a opravách:

www.aeg.com/support



Zaregistrujte si výrobok a využite tak ešte lepší servis:

www.registreaeg.com



Pre váš spotrebič si môžete zakúpiť príslušenstvo, spotrebný materiál a originálne náhradné diely:

www.aeg.com/shop



Stiahnite si aplikáciu **My AEG Kitchen** pre viac receptov, užitočných tipov a návodov na riešenie problémov.





STAROSTLIVOSŤ O ZÁKAZNÍKA A ZÁKAZNÍCKY SERVIS

Vždy používajte originálne náhradné diely.

Ak potrebujete kontaktovať autorizované servisné stredisko, uistite sa, že máte k dispozícii nasledujúce údaje: Model, číslo výrobku, sériové číslo.

Tieto informácie nájdete na typovom štítku.

 Upozornenie / Výstražné a bezpečnostné informácie

 Všeobecné informácie a tipy

 Informácie o životnom prostredí

Vyhradzujeme si právo na zmeny bez predchádzajúceho upozornenia.

OBSAH

1. BEZPEČNOSTNÉ INFORMÁCIE.....	406	2.4 Starostlivosť a čistenie.....	410
1.1 Bezpečnosť detí a zraniteľných osôb.....	406	2.5 Pyrolytické čistenie.....	411
1.2 Všeobecná bezpečnosť.....	407	2.6 Vnútorne osvetlenie.....	411
2. BEZPEČNOSTNÉ POKYNY.....	408	2.7 Servis.....	412
2.1 Montáž.....	408	2.8 Likvidácia.....	412
2.2 Elektrické zapojenie.....	409	3. POPIS VÝROBKU.....	412
2.3 Použitie.....	410	3.1 Všeobecný prehľad.....	412
		3.2 Príslušenstvo.....	413

4. AKO ZAPNÚŤ A VYPNÚŤ RÚRU.....	413	10. TIPY A RADY.....	427
4.1 Zasúvacie ovládače.....	413	10.1 Vlhký horúci vzduch.....	427
4.2 Ovládací panel.....	414	10.2 Vlhký horúci vzduch – odporúčané príslušenstvo.....	428
5. PRED PRVÝM POUŽITÍM.....	415	10.3 Tabuľky pečenia pre skúšobné inštitúty.....	428
5.1 Prvé čistenie.....	415	11. OŠETROVANIE A ČISTENIE.....	430
5.2 Počiatočný predohrev.....	415	11.1 Poznámky k čisteniu.....	431
6. KAŽDODENNÉ POUŽÍVANIE.....	415	11.2 Čistenie: Reliéf dutiny.....	431
6.1 Ako nastaviť: Funkcie ohrevu.....	416	11.3 Vybratie: Zasúvacie lišty.....	431
6.2 Funkcie ohrevu.....	416	11.4 Spôsob používania: Čistenie pyrolýzou.....	432
6.3 Poznámky k: Vlhký horúci vzduch.....	418	11.5 Pripomienka čistenia.....	433
6.4 Ako nastaviť: Sprievodca pečením.....	418	11.6 Vybratie a inštalácia: Dvierka....	433
6.5 Sprievodca pečením s receptami	418	11.7 Výmena: Osvetlenie.....	434
7. ČASOVÉ FUNKCIE.....	424	12. RIEŠENIE PROBLÉMOV.....	435
7.1 Časové funkcie.....	424	12.1 Čo robiť, ak.....	435
7.2 Ako nastaviť: Časové funkcie.....	424	12.2 Servisné údaje.....	437
8. POUŽÍVANIE: PRÍSLUŠENSTVO.....	425	13. ENERGETICKÁ ÚČINNOSŤ.....	437
8.1 Vloženie príslušenstva.....	426	13.1 Informácie o výrobku a informačný list k výrobku*.....	437
9. DOPLNKOVÉ FUNKCIE.....	426	13.2 Úspora energie.....	438
9.1 Blokovanie.....	427	14. ŠTRUKTÚRA PONUKY.....	438
9.2 Automatické vypínanie.....	427	14.1 Ponuka.....	438
9.3 Chladiaci ventilátor.....	427		

1. ⚠ BEZPEČNOSTNÉ INFORMÁCIE

Pred inštaláciou a používaním spotrebiča si pozorne prečítajte priložený návod na používanie. Výrobca nezodpovedá za zranenia ani za škody spôsobené nesprávnou montážou alebo používaním. Tieto pokyny uskladnite na bezpečnom a prístupnom mieste, aby ste do nich mohli v budúcnosti nahliadnuť.

1.1 Bezpečnosť detí a zraniteľných osôb

- Tento spotrebič smú používať deti staršie ako 8 rokov a osoby so zníženou fyzickou, zmyslovou alebo psychickou spôsobilosťou alebo nedostatkom skúseností a znalostí, iba ak sú pod dozorom zodpovednej osoby alebo ak boli zodpovednou osobou poučené o bezpečnom používaní

- spotrebiča a rozumejú prípadným rizikám. Deti do 8 rokov a osoby s vysokou mierou postihnutia nesmú mať prístup k spotrebiču, pokiaľ nie sú pod nepretržitým dozorom.
- Deti by mali byť pod dozorom, aby sa zabezpečilo, že sa so spotrebičom nebudú hrať.
 - Obaly vždy uschovajte mimo dosah detí a náležite ich zlikvidujte.
 - **UPOZORNENIE:** Nedovoľte deťom ani domácim zvieratám priblížiť sa k spotrebiču počas prevádzky alebo keď sa ochladzuje. Prístupné časti sa počas používania zohrejú na vysokú teplotu.
 - Ak má spotrebič detskú poistku, mala by byť zapnutá.
 - Deti nesmú spotrebič bez dozoru čistiť ani vykonávať žiadnu údržbu na spotrebiči.

1.2 Všeobecná bezpečnosť

- Nainštalovať tento spotrebič a vymeniť kábel smie iba na to kvalifikovaná osoba.
- Spotrebič nepoužívajte pred jeho nainštalovaním do nábytku určeného na zabudovanie.
- Pred akoukoľvek údržbou opojte spotrebič od elektrickej siete.
- Ak je poškodený elektrický napájací kábel, musíte ho dať vymeniť u výrobcu, v autorizovanom servisnom stredisku alebo u kvalifikovanej osoby, aby sa predišlo nebezpečenstvu.
- **VAROVANIE:** Dbajte na to, aby bol spotrebič pred výmenou žiarovky vypnutý, aby bolo vylúčené nebezpečenstvo zásahu elektrickým prúdom.
- **VAROVANIE:** Spotrebič a jeho prístupné časti sa počas používania môžu značne zahriať. Nedotýkajte sa ohrevných článkov.
- Pri vyberaní alebo vkladaní príslušenstva alebo nádob na pečenie vždy používajte kuchynské rukavice.

BEZPEČNOSTNÉ POKYNY

- Ak chcete vybrať zasúvacie lišty, najprv potiahnite prednú časť zasúvacích lišt a potom zadný koniec smerom od bočnej steny a vyberte ich. Pri inštalácii zasúvacích lišt zvolte opačný postup.
- Na čistenie spotrebiča nepoužívajte parné čističe.
- Na čistenie skla dvierok nepoužívajte abrazívne prostriedky ani ostré kovové škrabky, pretože by mohli poškrabať povrch, čo môže spôsobiť rozbitie skla.
- Vyliate zvyšky treba odstrániť pred pyrolytickým čistením. Z rúry vyberte všetky súčasti.

2. BEZPEČNOSTNÉ POKYNY

2.1 Montáž



VAROVANIE!

Tento spotrebič smie nainštalovať iba kvalifikovaná osoba.

- Odstráňte všetky obaly.
- Poškodený spotrebič neinštalujte ani nepoužívajte.
- Dodržiavajte pokyny na inštaláciu dodané so spotrebičom.
- Vždy dávajte pozor, ak presúvate spotrebič, pretože je ťažký. Vždy používajte ochranné rukavice a uzavretú obuv.
- Spotrebič neťahajte za rukoväť.
- Spotrebič nainštalujte na bezpečné a vhodné miesto, ktoré spĺňa požiadavky na inštaláciu.
- Dodržiavajte požadovanú minimálnu vzdialenosť od iných spotrebičov a nábytku.
- Pred namontovaním spotrebiča skontrolujte, či sa dvierka rúry otvárajú bez odporu.
- Spotrebič je vybavený elektrickým systémom chladenia. Ten musí byť napájaný z elektrickej siete.
- Vstavaná jednotka musí spĺňať požiadavky normy DIN 68930 na stabilitu.

Minimálna výška kuchynskej skrinky (minimálna výška skrinky pod pracovnou doskou)	578 (600) mm
Šírka kuchynskej skrinky	560 mm
Hĺbka kuchynskej skrinky	550 (550) mm
Výška prednej časti spotrebiča	594 mm
Výška zadnej časti spotrebiča	576 mm
Šírka prednej časti spotrebiča	595 mm

Šírka zadnej časti spotrebiča	559 mm
Hĺbka spotrebiča	567 mm
Hĺbka zabudovaného spotrebiča	546 mm
Hĺbka s otvorenými dvierkami	1027 mm
Minimálna veľkosť vetracieho otvoru. Otvor umiestnený na spodnej zadnej strane	560 x 20 mm
Dĺžka napájacieho kábla. Kábel sa nachádza v pravom rohu na zadnej strane	1500 mm
Montážne skrutky	4 x 25 mm

2.2 Elektrické zapojenie



VAROVANIE!

Nebezpečenstvo požiaru a zásahu elektrickým prúdom.

- Všetky elektrické zapojenia by mal vykonať kvalifikovaný elektroinštalatér.
- Spotrebič musí byť uzemnený.
- Uistite sa, že parametre na typovom štítku sú kompatibilné s elektrickým napätím zdroja napájania.
- Vždy používajte správne nainštalovanú zásuvku odolnú proti nárazom.
- Nepoužívajte viaczásuvkové adaptéry ani predlžovacie káble.
- Uistite sa, že zástrčka a prívodný elektrický kábel nie sú poškodené. Ak prívodný elektrický kábel spotrebiča treba vymeniť, túto operáciu smie urobiť iba pracovník autorizovaného servisného strediska.
- Nedovoľte, aby sa napájacie elektrické káble dotkli alebo dostali do blízkosti dvierok spotrebiča alebo výklenku pod spotrebičom najmä vtedy, keď sú dvierka horúce.
- Zariadenie na ochranu pred dotykom elektrických častí pod napätím a izolovaných častí treba namontovať tak, aby sa nedalo odstrániť bez nástrojov.
- Sieťovú zástrčku pripojte do sieťovej zásuvky až po dokončení inštalácie. Po inštalácii sa uistite, že máte prístup k sieťovej zástrčke.
- Ak je sieťová zásuvka uvoľnená, nezapájajte do nej sieťovú zástrčku.
- Spotrebič neodpájajte ťahaním za napájací kábel. Vždy ťahajte za sieťovú zástrčku.
- Použite iba správne odpájacie zariadenia: ochranné ističe alebo poistky (skrutkovacie poistky treba vybrať z držiaka), uzemnenia a stýkače.
- Elektrická sieť v domácnosti musí mať odpájacie zariadenie, ktoré umožní odpojenie spotrebiča od elektrickej siete na všetkých póloch. Vzdialenosť kontaktov odpájacieho zariadenia musí byť minimálne 3 mm.
- Skôr ako zapojíte sieťovú zástrčku do sieťovej zásuvky, úplne zavrite dvierka spotrebiča.
- Tento spotrebič sa dodáva s napájacou zástrčkou a napájacím káblom.

2.3 Použitie



VAROVANIE!

Hrozí nebezpečenstvo poranenia, popálenín, zásahu elektrickým prúdom alebo výbuchu.

- Tento spotrebič je určený iba na použitie v domácnosti (vo vnútri).
- Nemeňte technické parametre tohto spotrebiča.
- Uistite sa, že nie sú otvory vetrania zablokované.
- Spotrebič počas prevádzky nenechávajte bez dozoru.
- Spotrebič po každom použití vypnite.
- Pri otváraní dvierok spotrebiča počas jeho prevádzky buďte opatrní. Môže z neho uniknúť horúci vzduch.
- Spotrebič neobsluhujte s mokkými rukami alebo keď je v kontakte s vodou.
- Na otvorené dvierka nevyvíjate tlak.
- Spotrebič nepoužívajte ako pracovný alebo skladovací povrch.
- Dvierka spotrebiča otvárajte opatrne. Používanie prísad s alkoholom môže spôsobiť zmiešanie alkoholu a vzduchu.
- Pri otváraní dvierok zabráňte kontaktu iskier alebo otvoreného plameňa so spotrebičom.
- Horľavé látky ani predmety, ktoré sú nasiaknuté horľavými látkami, nekladte do spotrebiča, do jeho blízkosti ani naň.



VAROVANIE!

Hrozí nebezpečenstvo poškodenia spotrebiča.

- Aby sa predišlo škode alebo zmene farby povrchovej úpravy:
 - Nedávajte priamo do spodnej časti spotrebiča riad alebo iné objekty.
 - Nedávajte priamo na dno dutiny spotrebiča alobal.
 - Nedávajte priamo do horúceho spotrebiča vodu.
 - Po ukončení prípravy pokrmu v rúre nenechávajte vlhký riad ani potraviny.
 - Pri odstraňovaní alebo inštalácii príslušenstva buďte opatrní.
- Zmena farby smaltu alebo ušľachtilej ocele nemá žiadny vplyv na výkon spotrebiča.
- Na vlhké koláče použite hlboký pekáč. Ovocné šťavy spôsobujú škvrny, ktoré môžu byť trvalé.
- Tento spotrebič je určený iba na prípravu jedál. Nesmie sa používať na iné účely, napríklad výhrev miestnosti.
- Dvierka rúry musia byť vždy pri pečení zavreté.
- Pri inštalácii spotrebiča za nábytkový panel (napr. dvere) zabezpečte, aby dvere neboli počas prevádzky spotrebiča nikdy zatvorené. Za zatvoreným nábytkovým panelom sa môže vytvoriť teplo a vlhkosť a môžu spôsobiť následné poškodenie spotrebiča, nábytku alebo podlahy. Nábytkový panel nezatvárajte, kým spotrebič po použití úplne nevychladne.

2.4 Starostlivosť a čistenie



VAROVANIE!

Hrozí nebezpečenstvo poranenia, požiaru alebo poškodenia spotrebiča.

- Pred vykonávaním údržby spotrebič vypnite a vytiahnite jeho zástrčku zo sieťovej zásuvky.
- Skontrolujte, či je spotrebič studený. Existuje riziko, že sklenené panely môžu prasknúť.
- Ak sú sklenené panely dvierok poškodené, bezodkladne ich nechajte vymeniť. Obráťte sa na autorizované servisné stredisko.

- Pri vyberaní dvierok zo spotrebiča postupujte opatrne. Dvierka sú ťažké!
- Spotrebič pravidelne čistite, aby ste predišli znehodnoteniu povrchového materiálu.
- Spotrebič čistite vlhkou mäkkou handričkou. Používajte iba neutrálne saponáty. Nepoužívajte abrazívne výrobky, špongie s abrazívnou vrstvou, rozpúšťadlá ani kovové predmety.
- Ak používate sprej na čistenie rúr, dodržiavajte bezpečnostné pokyny na jeho obale.

2.5 Pyrolytické čistenie



VAROVANIE!

Hrozí nebezpečenstvo poranenia / požiaru / chemických emisií (výparov) v pyrolytickom režime.

- Pred vykonaním funkcie pyrolytického samočistenia alebo postupu na prvé použitie odstráňte z vnútra rúry:
 - všetky zvyšky jedla, oleja alebo tuku a iné nečistoty.
 - všetky vyberateľné predmety (vrátane roštov, bočných zásuvných mriežok a pod., ktoré boli dodané s produktom), predovšetkým však neprílnavé hrnce, panvice, pekáče, nástroje a pod.
- Pozorne si prečítajte všetky pokyny týkajúce sa pyrolytického čistenia.
- Keď je spustené pyrolytické čistenie, nepúšťajte deti k spotrebiču. Spotrebič sa veľmi zohreje a z predných chladiacich otvorov uniká horúci vzduch.
- Pyrolytické čistenie je proces využívajúci veľmi vysokú teplotu, pri ktorom môže dôjsť k tvorbe dymu zo zvyškov jedla a konštrukčných materiálov, preto používateľom dôrazne odporúčame:
 - v priebehu pyrolytického čistenia a po ňom zabezpečiť dobré vetranie.
 - počas prvého použitia pri maximálnej teplote a po ňom zabezpečiť dobré vetranie.
- Na rozdiel od ľudí môžu byť niektoré vtáky a plazy extrémne citlivé na prípadné výpary vznikajúce počas čistiacieho procesu všetkých pyrolytických rúr.
 - V priebehu pyrolytického čistenia sa domáce zvieratá (najmä vtáky) nesmú dostať do blízkeho okolia spotrebiča a pri prvom použití funkcie pyrolytického čistenia alebo maximálnej teploty zabezpečte dostatočné vetranie.
- Malé zvieratá môžu byť tiež veľmi citlivé na lokálne zmeny teploty v blízkosti všetkých pyrolytických rúr počas programu pyrolytického samočistenia.
- Nelepivé povrchy hrncov, panvíc, plechov, kuchynského riadu a pod. sa môžu poškodiť vysokou teplotou pri pyrolytickom čistení vo všetkých pyrolytických rúrach a môžu byť tiež zdrojom nízkej úrovne škodlivých výparov.
- Opísané výpary, ktoré sa uvoľňujú zo všetkých pyrolytických rúr/zvyškov po varení, nie sú škodlivé pre ľudí vrátane detí ani ľudí so zdravotnými problémami.

2.6 Vnútorne osvetlenie



VAROVANIE!

Hrozí nebezpečenstvo zásahu elektrickým prúdom.

- Informácie o žiarovke/žiarovkách vnútri tohto výrobku a náhradných dieloch osvetlenia, ktoré sa predávajú samostatne: Tieto žiarovky sú navrhnuté tak, aby odolali extrémnym podmienkam v domácich spotrebičoch, ako napr. teplota, vibrácie, vlhkosť, alebo slúžia ako ukazovatele prevádzkového stavu spotrebiča. Nie sú určené na používanie iným spôsobom a nie sú vhodné na osvetlenie priestorov v domácnosti.
- Používajte iba žiarovky s rovnakými technickými parametrami .

POPIS VÝROBKU

2.7 Servis

- Ak treba dať spotrebič opraviť, obráťte sa na autorizované servisné stredisko.
- Používajte iba originálne náhradné diely.

2.8 Likvidácia



VAROVANIE!

Hrozí nebezpečenstvo poranenia alebo udusenía.

- Spotrebič odpojte od elektrickej siete.
- Prívodný elektrický kábel odrežte blízko pri spotrebiči a zlikvidujte ho.
- Odstráňte západku dverok, aby ste zabránili uviaznutiu alebo domácich zvierat v spotrebiči.

3. POPIS VÝROBKU

3.1 Všeobecný prehľad

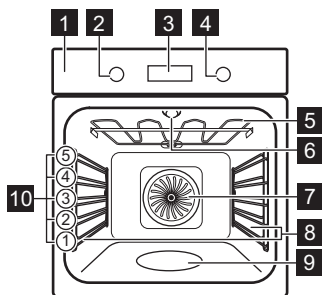

- 1** Ovládací panel
- 2** Ovládač funkcií ohrevu
- 3** Displej
- 4** Otočný ovládač
- 5** Ohrevný prvok
- 6** Osvetlenie
- 7** Ventilátor
- 8** Zasúvací lišta, odstrániteľná
- 9** Úrovne roštu v rúre
- 10** Priehlbina dutiny

3.2 Príslušenstvo

Drôtený rošt

Pre kuchynský riad, koláčové formy, nádoby na pečenie.

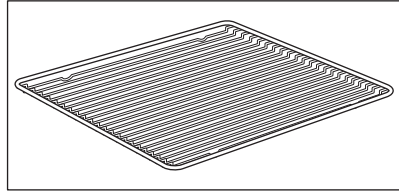

Plech na pečenie

Pre koláče a piškótové koláče.

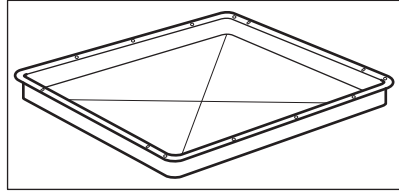

Hlboký pekáč

Na pečenie alebo ako pekáč na zber tuku.

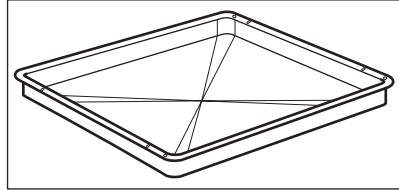

Teleskopické lišty

Na jednoduchšie vloženie a vybratie plechov a drôteného roštu.

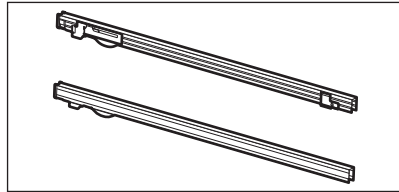







4. AKO ZAPNÚŤ A VYPNÚŤ RÚRU



4.1 Zasúvacie ovládače

Ak chcete spotrebič použiť, stlačte ovládač. Ovládač sa vysunie.

AKO ZAPNÚŤ A VYPNÚŤ RÚRU

4.2 Ovládací panel

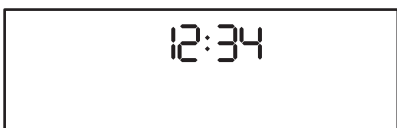
Senzorové polia ovládacieho panela					Stláčajte	Otočte otočný ovládač
 Časovač	 Rýchle zohrievanie	 Osvetlenie rúry	 Lock	OK		
Rúru zapnete zvolením funkcie ohrevu.						
Rúru vypnete otočením ovládača funkcií ohrevu do polohy Vyp.						

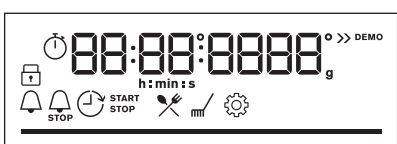
	Keď je ovládač funkcií ohrevu v polohe Vyp., displej sa prepne do pohotovostného režimu.
	Keď pečiete, na displeji sa zobrazuje nastavená teplota, presný čas a ostatné dostupné funkcie.
	Displej s maximálnym počtom nastavených funkcií.

Ukazovatele na displeji				
 Blokovanie	 Sprievodca pečením	 Čistenie	 Nastavenia	 Rýchle zohrievanie
Ukazovatele časovača:				

Lišta priebehu – pre teplotu alebo čas.	
--	---

Ukazovateľ pečenia s parou



5. PRED PRVÝM POUŽITÍM



VAROVANIE!

Pozrite si kapitoly ohľadne bezpečnosti.

5.1 Prvé čistenie

Pred prvým použitím prázdnu rúru vyčistite a nastavte čas:



0:00

Nastavte čas. Stlačte tlačidlo: OK.

5.2 Počiatočný predohrev



Pred prvým použitím prázdnu rúru predhrejete.

Krok č.
1

Vyberte z rúry vyberateľné zasúvacie lišty a príslušenstvo.

Krok č.
2

Nastavte maximálnu teplotu pre funkciu: .
Rúru nechajte spustenú jednu hodinu.

Krok č.
3

Nastavte maximálnu teplotu pre funkciu: .
Rúru nechajte spustenú 15 minút.



Rúra môže počas predohrevu produkovať zápach a dym. Skontrolujte, či je miestnosť vetraná.



6. KAŽDODENNÉ POUŽÍVANIE





VAROVANIE!

Pozrite si kapitoly ohľadne bezpečnosti.

6.1 Ako nastaviť: Funkcie ohrevu









Spustiť varenie	
Krok č. 1	Krok č. 2
	
Nastavte funkciu ohrevu.	Nastavte teplotu.

Parné varenie			
Skontrolujte, či je rúra studená.			
Krok č. 1	Krok č. 2	Krok č. 3	Krok č. 4
			Prázdnu rúru predhrievajte 10 minút, aby sa vytvorila vlhkosť. Vložte jedlo do rúry.
Priehlbnu dutiny rúry naplňte vodou z vodovodu.	Nastavte funkciu ohrevu parou.	Nastavte teplotu.	
i Maximálna kapacita priehlbny dutiny je 250 ml. Priehlbnu dutiny rúry nenapĺňajte vodou počas pečenia, ani keď je rúra horúca.			

Keď pečenie s parou skončí:		
Krok č. 1	Krok č. 2	Krok č. 3
rúru vypnete otočením ovládača funkcií ohrevu do polohy Vyp.	Dvierka opatrne otvorte. Uvoľnená vlhkosť môže spôsobiť popáleniny.	Skontrolujte, či je rúra studená. Odstráňte zvyškovú vodu z priehlbny dutiny rúry.

6.2 Funkcie ohrevu

Štandardné funkcie ohrevu

Funkcia ohrevu	Aplikácia
 <p>Teplovzdušné Pečenie</p>	<p>Na pečenie na 3 úrovniach súčasne a na sušenie potravín. Nastavte o 20 – 40 °C nižšiu teplotu než pre Tradičné pečenie.</p>
 <p>Tradičné pečenie</p>	<p>Na pečenie a opekanie na jednej úrovni roštu.</p>
 <p>SteamBake</p>	<p>Na pridanie vlhkosti počas prípravy jedál. Na získanie správnej farby a chrumkavej kôrky počas pečenia. Na zvýšenie šťavnatosti počas opätovného zohrievania. Na zaváranie ovocia a zeleniny.</p>
 <p>Pizza</p>	<p>Na prípravu pizze. Na intenzívnejšie zhnedenutie povrchu a chrumkavý korpus.</p>
 <p>Dolný ohrev</p>	<p>Na pečenie koláčov s chrumkavým korpusom a na zaváranie potravín.</p>
 <p>Mrazené pokrmy</p>	<p>Na prípravu chrumkavých polotovarov (napr. zemiakových hranolčekov, amerických zemiakov alebo jarných závitkov).</p>
 <p>Vlhký horúci vzduch</p>	<p>Táto funkcia je určená na úsporu energie počas prípravy jedál. Keď použijete túto funkciu, teplota v dutine sa môže líšiť od nastavenej teploty. Použije sa zvyškové teplo. Výkon ohrevu môže byť znížený. Viac informácií nájdete v kapitole „Každodenné používanie“, poznámky k: Vlhký horúci vzduch.</p>
 <p>Gril</p>	<p>Na grilovanie tenkých kúskov jedla a na prípravu hriankov.</p>
 <p>Turbo gril</p>	<p>Na pečenie veľkých kusov mäsa alebo hydiny s kosťami na jednej úrovni. Na gratinovanie a zapekanie.</p>

Funkcia ohrevu	Aplikácia
 Ponuka	Vstup do ponuky: Sprievodca pečením, Čistenie, Nastavenia.

6.3 Poznámky k: Vlhký horúci vzduch

Táto funkcia bola použitá na zaradenie do triedy energetickej účinnosti a splnenie požiadaviek na ekologický dizajn podľa predpisov EÚ 65/2014 a EÚ 66/2014. Testy podľa normy EN 60350-1.







Dvierka rúry majú byť počas pečenia zatvorené, aby nedošlo k prerušeniu funkcie a aby bola zabezpečená čo najefektívnejšia prevádzka rúry.

Keď použijete túto funkciu, osvetlenie sa po 30 sekundách automaticky vypne.



Pokyny ohľadom varenia nájdete v kapitole „Rady a tipy“, Vlhký horúci vzduch. Všeobecné odporúčania na úsporu energie si pozrite v kapitole „Energetická účinnosť“, v časti Úspora energie.

6.4 Ako nastaviť: Sprievodca pečením

Každý pokrm v tejto podponuke má odporúčanú funkciu a teplotu. Počas varenia môžete upraviť čas a teplotu.

Sprievodca pečením – na rýchlu prípravu pokrmu s predvolenými nastaveniami:			
Krok č. 1	Krok č. 2	Krok č. 3	Krok č. 4
 	 	 1 - 45	 OK
Vstúpte do ponuky.	Vyberte Sprievodca pečením. Stlačte OK .	Vyberte pokrm. Stlačte tlačidlo OK .	Vložte pokrm do rúry. Potvrďte nastavenia.









6.5 Sprievodca pečením s receptami

Legenda	
	Množstvo vody na parnú funkciu.
	Pred pečením rúru predhrejte.
	Úroveň roštu.













Keď funkcia skončí, skontrolujte, či je pokrm hotový.

	Pokrm	Hmotnosť	Úroveň roštu/príslušenstvo	Trvanie
Hovädzie 🍖				
P1	Pečené hovädzie, neprepečené	1 – 1,5 kg; 4 – 5 cm hrubé kúsky	☐ 2; plech na pečenie Mäso niekoľko minút smažte na horúcej panvici. Vložte do rúry.	40 min
P2	Hovädzie pečené, stredne prepečené			50 min
P3	Hovädzie pečené, prepečené			60 min
P4	Steak, stredne prepečený	180 – 220 g/kus; 3 cm hrubé plátky	☐☐ 3; nádoba na pečenie na drôtenom rošte Mäso niekoľko minút smažte na horúcej panvici. Vložte do rúry.	15 min
P5	Hovädzie pečené/dusené (prvotriedne hovädzie rebro, mäso z horného stehna, hrubý bok)	1,5 – 2 kg	☐ 2; nádoba na pečenie na drôtenom rošte Mäso niekoľko minút smažte na horúcej panvici. Dolejte tekutinu. Vložte do rúry.	120 min
P6	Hovädzie pečené, neprepečené (pomalé pečenie)	1 – 1,5 kg; 4 – 5 cm hrubé kúsky	☐ 2; plech na pečenie Použite svoje obľúbené koreniny alebo jednoducho soľ a čerstvo namleté korenie. Mäso niekoľko minút smažte na horúcej panvici. Vložte do rúry.	75 min
P7	Hovädzie pečené, stredne prepečené (pomalé pečenie)			85 min
P8	Hovädzie pečené, dobre prepečené (pomalé pečenie)			130 min























KAŽDODENNÉ POUŽÍVANIE

	Pokrm	Hmotnosť	Úroveň roštu/príslušenstvo	Trvanie
P9	Filety, neprepečené (pomalé pečenie)	0,5 – 1,5 kg; 5 – 6 cm hrubé kusky	 2; plech na pečenie Použite svoje obľúbené koreniny alebo jednoducho soľ a čerstvo namleté korenie. Mäso niekoľko minút smažte na horúcej panvici. Vložte do rúry.	75 min
P10	Filety, stredne prepečené (pomalé pečenie)			90 min
P11	Filety, prepečené (pomalé pečenie)			120 min
Teľacie 				
P12	Teľacie pečenné (napr. plece)	0,8 – 1,5 kg; 4 cm hrubé kusky	 2; nádoba na pečenie na drôtenom rošte Použite svoje obľúbené koreniny. Dolejte tekutinu. Pečte prikryté.	80 min
Bravčové 				
P13	Pečená bravčová krkovička alebo plece	1,5 – 2 kg	 2; nádoba na pečenie na drôtenom rošte Po polovici doby prípravy mäso obráťte.	120 min
P14	Trhané pečenné bravčové LTC	1,5 – 2 kg	 2; plech na pečenie Použite svoje obľúbené koreniny. Pre rovnomerné opečenie po polovici doby prípravy mäso obráťte.	215 min
P15	Čerstvé karé	1 – 1,5 kg; 5 – 6 cm hrubé kusky	 2; nádoba na pečenie na drôtenom rošte Použite svoje obľúbené koreniny.	55 min
P16	Rebierka	2 – 3 kg; použite surové rebierka hrubé 2 – 3 cm	 3; hlboká panvica Dolejte tekutinu tak, aby pokryla dno nádoby. Po polovici doby prípravy mäso obráťte.	90 min
Jahňacie 				



















KAŽDODENNÉ POUŽÍVANIE

	Pokrm	Hmotnosť	Úroveň roštu/príslušenstvo	Trvanie
P17	Jahňacie stehno s kosťami	1,5 – 2 kg; 7 – 9 cm hrubé kúsky	 2 ; nádoba na pečenie na plechu na pečenie Dolejte tekutinu. Po polovici doby prípravy mäso obráťte.	130 min
Hydina 				
P18	Celé kurča	1 – 1,5 kg; čerstvé	 2 ;  200 ml; nádoba na zapekanie na plechu na pečenie Použite svoje obľúbené koreniny. Pre rovnomerné opečenie po polovici doby prípravy kurča obráťte.	60 min
P19	Polovička kurčatá	0,5 – 0,8 kg	 3 ; plech na pečenie Použite svoje obľúbené koreniny.	40 min
P20	Kuracie prsia	180 – 200 g/kus	  2 ; nádoba na zapekanie na drôtenom rošte Použite svoje obľúbené koreniny. Mäso niekoľko minút smažte na horúcej panvici.	25 min
P21	Kuracie stehná, čerstvé	-	 3 ; plech na pečenie Ak ste kuracie stehná najskôr marinovali, nastavte nižšiu teplotu a pečte ich dlhšie.	30 min
P22	Celá kačka	2 – 3 kg	 2 ; nádoba na pečenie na drôtenom rošte Použite svoje obľúbené koreniny. Položte mäso na nádobu na pečenie. Po polovici doby prípravy kačku obráťte.	100 min
P23	Celá hus	4 – 5 kg	 2 ; hlboká panvica Použite svoje obľúbené koreniny. Položte mäso na hlboký plech na pečenie. Po polovici doby prípravy hus obráťte.	110 min
Iné 				
P24	Sekaná	1 kg	 2 ; drôtený rošt Použite svoje obľúbené koreniny.	60 min



KAŽDODENNÉ POUŽÍVANIE

	Pokrm	Hmotnosť	Úroveň roštu/príslušenstvo	Trvanie
 Ryby				
P25	Celá ryba, grilovaná	0,5 – 1 kg na rybu	 2; plech na pečenie Naplníte rybu maslom a použijete svoje obľúbené koreniny a bylinky.	30 min
P26	Rybie filé	-	 3; zapekacia nádoba na drôtenom rošte Použijete svoje obľúbené koreniny.	20 min
Sladké pečivo/dezerty   				
P27	Tvarohový koláč	-	 2;  28 cm rozkladacia forma na tortu na drôtenom rošte	90 min
P28	Jablkový koláč	-	 2;  100 – 150 ml; plech na pečenie	60 min
P29	Jablková torta	-	 2; okrúhla forma na koláč na drôtenom rošte	40 min
P30	Jablkový koláč	-	 2;  100 – 150 ml;  22 cm okrúhla forma na koláč na drôtenom rošte	60 min
P31	Brownies – čok. sušienky	2 kg	 3; hlboká panvica	30 min
P32	Čokoládové muffiny	-	 2;  100 – 150 ml; plech na muffiny na drôtenom rošte	30 min
P33	Bochníkový koláč	-	 2; forma na bochník na drôtenom rošte	50 min
Zelenina/prílohy   				
P34	Pečené zemiaky	1 kg	 2; plech na pečenie Na plech na pečenie položte celé zemiaky so šupkou.	50 min

KAŽDODENNÉ POUŽÍVANIE





	Pokrm	Hmotnosť	Úroveň roštu/príslušenstvo	Trvanie
P35	Americké zemiaky	1 kg	 3; plech na pečenie vystlaný papierom na pečenie Použite svoje obľúbené koreniny. Nakrájajte zemiaky na kúsky.	35 min
P36	Grilovaná miešaná zelenina	1 – 1,5 kg	 3; plech na pečenie vystlaný papierom na pečenie Použite svoje obľúbené koreniny. Zeleninu nakrájajte na kúsky.	30 min
P37	Krokety, mrazené	0,5 kg	 3; plech na pečenie	25 min
P38	Hranolčeky, mrazené	0,75 kg	 3; plech na pečenie	25 min
Gratinovanie, chlieb a pizza   				
P39	Lasagne/ rezance v zapiekacej nádobe	1 – 1,5 kg	 2; zapiekacia nádoba na drôtenom rošte	45 min
P40	Zapečené zemiaky	1 – 1,5 kg	 1; zapiekacia nádoba na drôtenom rošte	50 min
P41	Čerstvá pizza, tenká	-	  2;  100 ml; plech na pečenie vystlaný papierom na pečenie	15 min
P42	Čerstvá pizza, hrubá	-	  2;  100 ml; plech na pečenie vystlaný papierom na pečenie	25 min
P43	Slaný koláč	-	 2; plech na pečenie na drôtenom rošte	45 min
P44	Bageta/ ciabatta/biely chlieb	0,8 kg	  3;  150 ml; plech na pečenie vystlaný papierom na pečenie Biely chlieb si vyžaduje viac času.	30 min

ČASOVÉ FUNKCIE



	Pokrm	Hmotnosť	Úroveň roštu/príslušenstvo	Trvanie
P45	Celozrnný/ rašný/tmavý celozrnný chlieb vo for- me na boch- ník	1 kg	  2;  150 ml; plech na pečenie vystlaný papierom na pečenie/ drôtený rošt	45 min

7. ČASOVÉ FUNKCIE





7.1 Časové funkcie







Funkcia časovača	Aplikácia
	Časomer. Po uplynutí času zaznie zvukový signál.
	Čas prípravy. Po uplynutí času zaznie zvukový signál a funkcia ohrevu sa vypne.
	Odklad nastavenia času. Odklad začiatku a/alebo konca varenia.
	Časovač. Maximálne 23 h 59 min. Táto funkcia nemá vplyv na činnosť rúry. Časovač zapnete a vypnete tak, že zvolíte: Ponuka, Nastavenia.

7.2 Ako nastaviť: Časové funkcie

Nastavenie: Presný čas		
Krok č. 1	Krok č. 2	Krok č. 3
		
Presný čas zmeníte tak, že vstúpite do ponuky a vyberiete Nastavenia, Presný čas.	Nastavte hodiny.	Stlačte tlačidlo: OK.

POUŽÍVANIE: PRÍSLUŠENSTVO

Nastavenie: Časomer			
Krok č. 1	Na displeji sa zobrazí: 0:00 	Krok č. 2	Krok č. 3
			
Stlačte tlačidlo:  .		Nastavte funkciu Časomer	Stlačte tlačidlo: OK.
 Časovač začne ihneď odpočítavať.			

Nastavenie: Čas prípravy				
Krok č. 1	Krok č. 2	Na displeji sa zobrazí: 0:00  STOP	Krok č. 3	Krok č. 4
				
Vyberte funkciu ohrevu a nastavte teplotu.	Opakovane stlačte:  .		Nastavte čas varenia.	Stlačte tlačidlo: OK.
 Časovač začne ihneď odpočítavať.				

Nastavenie: Odklad nastavenia času							
Krok č. 1	Krok č. 2	Na displeji sa zobrazí: presný čas  ŠTART	Krok č. 3	Krok č. 4	Na displeji sa zobrazí: --:--  STOP	Krok č. 5	Krok č. 6
							
Vyberte funkciu ohrevu.	Opakovane stlačte:  .		Nastavte čas spustenia.	Stlačte tlačidlo: OK.		Nastavte čas skončenia.	Stlačte tlačidlo: OK.
 Časovač začne odpočítavať v nastavenom čase spustenia.							

8. POUŽÍVANIE: PRÍSLUŠENSTVO

8.1 Vloženie príslušenstva

Malé zarážky na vrchu zvyšujú bezpečnosť. Tieto zarážky zároveň zabraňujú prevrhnutiu. Vysoký okraj okolo roštu zabraňuje zošmyknutiu kuchynského riadu z roštu.

Drôtený rošt:

Rošt zasunúte medzi vodiace tyče zasúvacích lišt .

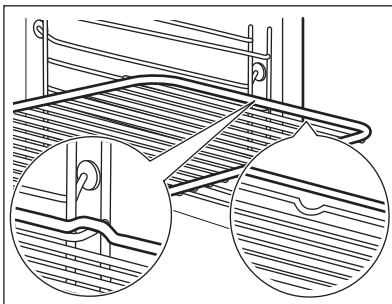

Plech na pečenie /Hlboký pekáč:

Plech na pečenie zasunúte medzi vodiace lišty zvolenej úrovne rúry.

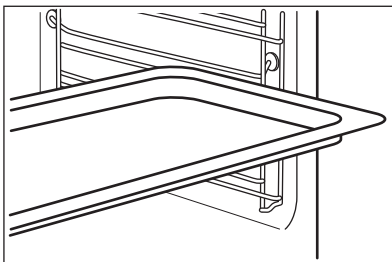



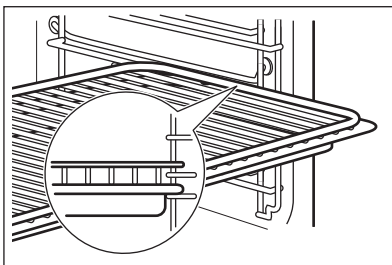

Drôtený rošt, Plech na pečenie /Hlboký pekáč:

Plech na pečenie zasunúte medzi vodiace lišty zvolenej úrovne rúry a drôtený rošt na vodiacich lištách.





9. DOPLNKOVÉ FUNKCIE

9.1 Blokovanie

Táto funkcia predchádza náhodnej zmene funkcie rúry.		
Zapnite ju, keď je rúra zapnutá – nastavená príprava pokrmu pokračuje, ovládací panel je zablokováný. Zapnite ju, keď je rúra vypnutá – rúra sa nedá zapnúť, ovládací panel je zablokováný.		
	 – stlačte a podržte, ak chcete zapnúť funkciu. Zaznie zvukový signál.	 – stlačte a podržte, ak to chcete vypnúť.
 3x  – zabliká, keď sa blokovanie zapne.		

9.2 Automatické vypínanie

Ak je zapnutá funkcia ohrevu a nezmeníte žiadne z nastavení, rúra sa z bezpečnostných dôvodov po určitom čase vypne.

 °C	 (h)
30 - 115	12.5
120 - 195	8.5
200 - 245	5.5
250 – maximum	3

Funkcia automatického vypnutia nebude fungovať pri týchto funkciách: Osvetlenie rúry, Odklad nastavenia času.



9.3 Chladiaci ventilátor

Ak je rúra zapnutá, automaticky sa aktivuje chladiaci ventilátor, aby udržal povrch rúry chladný. Ak vypnete rúru, chladiaci ventilátor môže zostať v činnosti, kým rúra nevychladne.

10. TIPY A RADY



10.1 Vlhký horúci vzduch

V záujme čo najlepších výsledkov sa riadte tipmi v tabuľke nižšie.
Použite tretiu úroveň v rúre.

	 (° C)	 (min)
Zapečené cestoviny	200 - 220	45 - 55
Zapečené zemiaky	180 - 200	70 - 85
Moussaka	170 - 190	70 - 95
Lasagne	180 - 200	75 - 90
Cannelloni	180 - 200	70 - 85
Chlebový puding	190 - 200	55 - 70
Ryžový puding	170 - 190	45 - 60
Jablkový koláč z piškótového cesta (okružla forma na koláče)	160 - 170	70 - 80
Biely chlieb	190 - 200	55 - 70

10.2 Vlhký horúci vzduch – odporúčané príslušenstvo

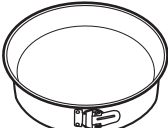
Použite tmavé a matné formy a nádoby. Absorbujú teplo lepšie ako svetlý a lesklý riad.

			
Forma na pizzu	Forma na pečenie	Nádoby na suflé	Forma na korpus
Tmavá, matná 28 cm priemer	Tmavá, matná 26 cm priemer	Keramická 8 cm priemer, 5 cm výška	Tmavá, matná 28 cm priemer





10.3 Tabuľky pečenia pre skúšobné inštitúty

Informácie pre skúšobne

Skúšky podľa: EN 60350, IEC 60350.



PEČENIE NA JEDNEJ ÚROVNI. Pečenie vo formách





		 (°C)	 (min)	
Piškótvý koláč bez tuku	Teplovzdušné Pečenie	140 - 150	35 - 50	2
Piškótvý koláč bez tuku	Tradičné pečenie	160	35 - 50	2
Jablkový koláč, 2 formy Ø20 cm	Teplovzdušné Pečenie	160	60 - 90	2
Jablkový koláč, 2 formy Ø20 cm	Tradičné pečenie	180	70 - 90	1



PEČENIE NA JEDNEJ ÚROVNI. Sušienky



Použite tretiu úroveň v rúre.

		 (°C)	 (min)
Linecké koláčiky / Prúžky pečiva	Teplovzdušné Pečenie	140	25 - 40
Linecké koláčiky / Prúžky pečiva, predhrejte prázdnu rúru	Tradičné pečenie	160	20 - 30
Malé koláčiky, 20 ks/plech, predhrejte prázdnu rúru	Teplovzdušné Pečenie	150	20 - 35
Malé koláčiky, 20 ks/plech, predhrejte prázdnu rúru	Tradičné pečenie	170	20 - 30

OŠETROVANIE A ČISTENIE



VIACÚROVNŔOVÉ PEČENIE. Sušienky

		 (°C)	 (min)	
Linecké koláčiky / Prúžky pečiva	Teplovzdušné Pečenie	140	25 - 45	1 / 4
Malé koláčiky, 20 ks/ plech, predhrejte prázdnu rúru	Teplovzdušné Pečenie	150	23 - 40	1 / 4
Piškótový koláč bez tuku	Teplovzdušné Pečenie	160	35 - 50	1 / 4



GRIL



Prázdnu rúru predhrievajte 5 minút.



Grilujte s maximálnou nastavenou teplotou.

		 (min)	
Hrianky	Gril	1 - 3	5
Hovädzí steak, po uplynutí polovice času obráťte	Gril	24 - 30	4



11. OŠETROVANIE A ČISTENIE



VAROVANIE!

Pozrite si kapitoly ohľadne bezpečnosti.

11.1 Poznámky k čisteniu

 <p>Čistiace pro- striedky</p>	<p>Prednú stranu rúry očistite mäkkou tkaninou namočenou v teplej vode s prídavkom čistiaceho prostriedku.</p>
	<p>Na čistenie kovových povrchov použite čistiaci roztok.</p>
	<p>Škrvny vyčistíte s miernym čistiacim prostriedkom.</p>
 <p>Každodenné používanie</p>	<p>Dutinu očistíte po každom použití. Hromadenie tuku alebo iných zvyškov môže mať na následok vznik požiaru.</p>
	<p>Jedlo v rúre neskladujte dlhšie ako 20 minút. Dutinu po každom použití vysušte jemnou handričkou.</p>
 <p>Príslušenstvo</p>	<p>Po každom použití vyčistíte všetko príslušenstvo a nechajte ho uschnúť. Použite mäkkú handričku namočenú v teplej vode s jemným čistiacim prostriedkom. Príslušenstvo sa nesmie umývať v umývačke riadu.</p>
	<p>Nelepivé príslušenstvo nečistíte abrazívnymi čistiacimi prostriedkami ani predmetmi s ostrými hranami.</p>

11.2 Čistenie: Reliéf dutiny

Vyčistite priehlbnu dutiny, aby ste odstránili zvyšky vodného kameňa po pečení s parou.

Krok č. 1	Krok č. 2	Krok č. 3
<p>Do priehlbny dutiny nalejte 250 ml bieleho octu. Použite maximálne 6 %-ný ocot bez prídavných látok.</p>	<p>Počkajte 30 minút, kým ocot nerozpustí zvyšky vodného kameňa pri teplote okolia.</p>	<p>Dutinu vyčistíte teplou vodou a mäkkou handričkou.</p>
<p>Pre funkciu: SteamBake vyčistíte rúru po každých 5 – 10 cykloch pečenia.</p>		

11.3 Vybratie: Zasúvacie lišty

Vyberte zasúvacie lišty, aby ste mohli očistiť rúru.

OŠETROVANIE A ČISTENIE

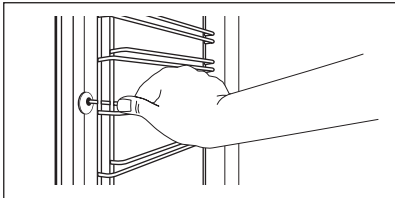
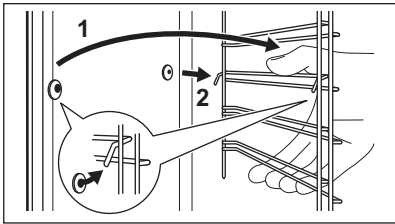
Krok č. 1	Rúru vypnite a počkajte, kým nevychladne.	
Krok č. 2	Odtiahnite prednú časť zasúvacích lišt od bočnej steny.	
Krok č. 3	Zadnú časť lišt odtiahnite od bočnej steny a lišty vyberte.	
Krok č. 4	Pri inštalácii zasúvacích lišt zvolte opačný postup. Upevňovacie kolíky na teleskopických lištách musia smerovať dopredu.	

11.4 Spôsob používania: Čistenie pyrolýzou

Čistenie rúry pomocou Čistenie pyrolýzou.



VAROVANIE!

Hrozí riziko popálenín.



UPOZORNENIE!



Ak sú v tej istej kuchynskej skrinke nainštalované ďalšie spotrebiče, nepoužívajte ich súčasne s touto funkciou. Mohlo by to spôsobiť poškodenie rúry.

Pred Čistenie pyrolýzou:

Rúru vypnite a počkajte, kým nevychladne.	Odstráňte všetko príslušenstvo a vyberateľné zasúvacie lišty.	Dno rúry a vnútorný sklenený panel dveriek vyčistite teplou vodou, mäkkou handričkou a miernym čistiacim prostriedkom.
---	---	--

Čistenie pyrolýzou

Krok č. 1	Vstupná ponuka: Čistenie $\frac{ml}{h}$.	
Voliteľná funkcia	Doba trvania	
C1 - Ľahké čistenie	1 h	
C2 - Normálne čistenie	1 h 30 min	

Čistenie pyrolýzou	
C3 - Dôkladné čistenie	3 h
Krok č. 2	OK – stlačením vyberte program čistenia.
Krok č. 3	OK – stlačením spustíte čistenie.
Krok č. 4	Po čistení otočte ovládač funkcií ohrevu do polohy Vypnuté.
 Počas čistenia je osvetlenie v rúre vypnuté.	
Keď rúra dosiahne nastavenú teplotu, dvierka sa zablokujú. Kým sa dvierka neodblokujú, na displeji sú zobrazené:  .	



Po skončení čistenia:		
Rúru vypnite a počkajte, kým nevychladne.	Vnútro vyčistite mäkkou handričkou.	Z dna rúry odstráňte zvyšky po čistení.

11.5 Pripomenka čistenia

Rúra vám pripomenie, že ju treba vyčistiť pyrolýzou.	
 bliká na displeji 5 sekúnd po každom pečení.	Na vypnutie pripomenky vstúpte do Ponuka a vyberte Nastavenia, Pripomenka čistenia.

11.6 Vybratie a inštalácia: Dvierka

Dvierka a vnútorné sklenené panely môžete vybrať, aby ste ich vyčistili. Počet sklenených panelov dvierok je pre rôzne modely odlišný.

	VAROVANIE! Dvierka sú ťažké.
	UPOZORNENIE! So sklom zaobchádzajte opatrne, predovšetkým okolo okrajov predného panela. Sklo môže prasknúť.

OŠETROVANIE A ČISTENIE

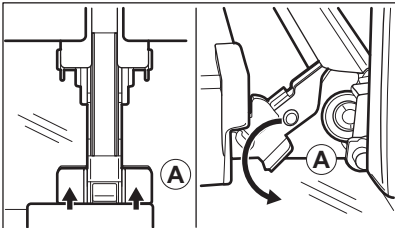
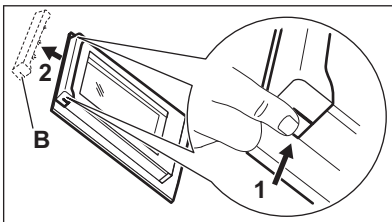
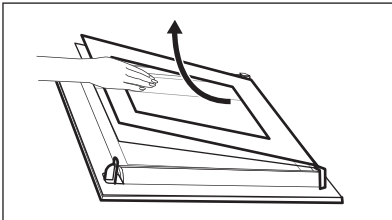
Krok č. 1	Dvierka úplne otvorte.	
Krok č. 2	Nadvihnite a stlačte upínacie páky (A) na oboch pántoch dvierok.	
Krok č. 3	Dvierka rúry privrite, aby zostali v prvej otvorenej polohe (približne v 70° uhle). Dvierka rúry uchopte po oboch stranách a potiahnite ich od rúry smerom nahor. Dvierka položte vonkajšou stranou nadol na mäkkú tkaninu na rovny povrch.	
Krok č. 4	Uchopte rám dvierok (B) po stranách v hornej časti a zatlačte ich smerom dnu, aby sa uvoľnila upevňovacia západka.	
Krok č. 5	Rám dvierok vyberte potiahnutím smerom dopredu.	
Krok č. 6	Sklenené panely dvierok uchopte na ich hornej hrane a po jednom ich vyťahnite smerom nahor z úchytiak.	
Krok č. 7	Sklenený panel vyčistíte vodou s prídavkom saponátu. Sklenený panel dôkladne osušte. Sklenené panely neumývajte v umývačke riadu.	
Krok č. 8	Po čistení zvoľte opačný postup.	
Krok č. 9	Najprv namontujte malý panel, potom väčší a dvierka. Uistite sa, že sú sklá vložené v správnej polohe, inak sa môže povrch dierok prehriať.	

11.7 Výmena: Osvetlenie



VAROVANIE!

Hrozí nebezpečenstvo zásahu elektrickým prúdom.
Žiarovka môže byť horúca.

Pred výmenou žiarovky v osvetlení:

Krok č. 1	Krok č. 2	Krok č. 3
Vypnite rúru. Počkajte, kým nebude rúra studená.	Rúru odpojte zo siete.	Na dno dutiny položte handričku.

Horné osvetlenie

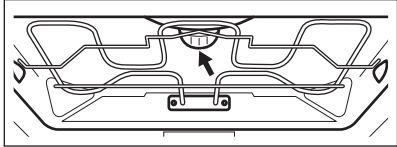
Krok č. 1	Otočte sklenený kryt a vyberte ho.	
Krok č. 2	Sklenený kryt vyčistite.	
Krok č. 3	Nahradte žiarovku inou vhodnou žiarovkou odolnou teplotám do 300 °C.	
Krok č. 4	Nasadte sklenený kryt.	

12. RIEŠENIE PROBLÉMOV



VAROVANIE!

Pozrite si kapitoly ohľadne bezpečnosti.

12.1 Čo robiť, ak...

V prípadoch, ktoré nie sú uvedené v tejto tabuľke, sa obráťte na autorizované servisné stredisko.

 Rúra sa nezapne ani sa nezohrieva	
Problém	Skontrolujte, či...
Rúra sa nedá zapnúť ani používať.	Rúra je správne pripojená ku zdroju elektrického napájania.
Rúra sa nezohrieva.	Deaktivovalo sa automatické vypínanie.

RIEŠENIE PROBLÉMOV



Rúra sa nezapne ani sa nezohrieva

Rúra sa nezohrieva.	Dvierka rúry sú zatvorené.
Rúra sa nezohrieva.	Nie je vypálená poistka.
Rúra sa nezohrieva.	Je vypnutá detská poistka.



Komponenty

Problém	Skontrolujte, či...
Osvetlenie je vypnuté.	Vlhký horúci vzduch – je zapnuté.
Žiarovka nefunguje.	Žiarovka je vypálená.



Chybové kódy

Displej zobrazuje...	Skontrolujte, či...
Err C3	Dvierka rúry sú zatvorené alebo je pokazené blokovanie dvierok.
Err F102	Dvierka rúry sú zatvorené.
Err F102	Blokovanie dvierok nie je pokazené.
0:00	Došlo k výpadku napájania. Nastavte presný čas.

Ak sa na displeji zobrazí chybový kód, ktorý nie je v tabuľke, vypnite domovú poistku a reštartujte rúru. Ak sa chybový kód objaví znova, obráťte sa na autorizované servisné stredisko.



Čistenie

Problém	Skontrolujte, či...
Z priehlbiny dutiny rúry vyteká voda.	V priehlbine dutiny rúry je priveľa vody.

12.2 Servisné údaje

Ak problém nedokážete odstrániť sami, kontaktujte predajcu alebo autorizované servisné stredisko.

Údaje potrebné pre autorizované servisné stredisko nájdete na typovom štítku. Typový štítok sa nachádza na prednom ráme vnútorného priestoru rúry. Neodstraňujte typový štítok z dutiny rúry.

Odporúčame, aby ste si sem zapísali tieto údaje:	
Model (MÓD.)
Číslo výrobku (PNC)
Sériové číslo (S.N.)

13. ENERGETICKÁ ÚČINNOSŤ

13.1 Informácie o výrobku a informačný list k výrobku*

Názov dodávateľa	AEG	
Model	BPB351160M 944188506 BPS351160M 944188507	
Index energetickej účinnosti	81.2	
Trieda energetickej účinnosti	A+	
Spotreba energie pri štandardnom naplnení, tradičný režim	1.09 kWh/cyklus	
Spotreba energie pri štandardnom naplnení, režim s ventilátorom	0.69 kWh/cyklus	
Počet dutín	1	
Zdroj tepla	Elektrina	
Objem	71 l	
Typ rúry	Zabudovateľná rúra	
Hmotnosť	BPB351160M	34.0 kg
	BPS351160M	34.0 kg

ŠTRUKTÚRA PONUKY

*Pre Európsku úniu podľa nariadení EÚ 65/2014 a 66/2014.
Pre Bieloruskú republiku podľa STB 2478-2017, Dodatok G; STB 2477-2017, Prílohy A a B.
Pre Ukrajinu podľa 568/32020.

Trieda energetickej účinnosti sa nevzťahuje na Rusko.

EN 60350-1 - Elektrické varné spotrebiče pre domácnosť. Časť 1: Sporáky, rúry, parné rúry a grily. Metódy merania výkonových parametrov.

13.2 Úspora energie



Rúra má funkcie, ktoré vám pomôžu usporiť energiu pri každodennom varení.

Uistite sa, že dvierka rúry sú počas jej prevádzky zatvorené. Počas pečenia dvierka rúry neotvárajte príliš často. Tesnenie dvierok udržiavajte čisté a uistite sa, že je upevnené na svojom mieste.

V záujme vyššej úspory energie použite kovový riad.

Ak je to možné, rúru pred pečením nepredhrievajte.

Keď pripravujete niekoľko pokrmov naraz, zachovajte čo najkratšie prestávky medzi pečením.

Pečenie s ventilátorom

Ak je to možné, použite funkcie pečenia s ventilátorom, aby ste dosiahli úsporu energie.

Zvyškové teplo

Ventilátor a osvetlenie budú naďalej v činnosti. Keď rúru vypnete, na displeji sa zobrazí zvyškové teplo. Teplo môžete použiť na udržanie teploty jedla.

Ak trvá pečenie dlhšie ako 30 minút, znížte teplotu rúry na minimum 3 – 10 minút pred koncom pečenia. Pomocou zvyškového tepla v rúre bude pečenie pokračovať.

Zvyškové teplo použite na ohrev ostatných pokrmov.

Uchovanie teploty jedla

Ak chcete jedlo uchovať teplé pomocou zvyškového tepla, zvolte najnižšie možné nastavenie teploty. Na displeji sa zobrazí ukazovateľ zvyškového tepla alebo teplota.

Pečenie s vypnutým osvetlením

Počas pečenia vypnite osvetlenie. Zapnite ho iba v prípade potreby.

Vlhký horúci vzduch

Funkcia určená na úsporu energie počas pečenia.



Keď používate túto funkciu, osvetlenie sa po 30 sekundách automaticky vypne. Osvetlenie môžete opäť zapnúť, ale tento úkon zníži očakávanú úsporu energie.

14. ŠTRUKTÚRA PONUKY

14.1 Ponuka





– vyberte pre vstup do Ponuka.

Ponuka štruktúra		
Sprievodca pečením 	Čistenie 	Nastavenia 

Krok č. 1	Krok č. 2	Krok č. 3	Krok č. 4	Krok č. 5
				
Vyberte Ponuka, Nastavenia.	Potvrďte nastavenia.	Vyberte nastavenie.	Potvrďte nastavenia.	Upravte hodnoty a stlačte OK.

Nastavenia					
O1	Presný čas	Zmeniť	O2	Jas displeja	1 - 5
O3	Tóny tlačidiel	1 – Pípnutie 2 – Cvaknutie 3 – Vypnutý zvuk	O4	Hlasitosť zvuku	1 - 4
O5	Časovač	Zap./Vyp.	O6	Osvetlenie rúry	Zap./Vyp.
O7	Rýchle zohrievanie	Zap./Vyp.	O8	Pripomenka čistenia	Zap./Vyp.
O9	Režim Demo	Aktivačný kód: 2468	O10	Verzia softvéru	Kontrola
O11	Zrušiť všetky nastavenia	Áno/nie			

15. OCHRANA ŽIVOTNÉHO PROSTREDIA

Materiály označené symbolom  odovzdajte na recykláciu. Obal hodte do príslušných kontajnerov na recykláciu. Chráňte životné prostredie a zdravie ľudí a recyklujte odpad z elektrických a elektronických spotrebičov. Nelikvidujte spotrebiče označené symbolom spolu s odpadom z domácnosti.  Výrobok odovzdajte v miestnom recyklačnom zariadení alebo sa obráťte na obecný alebo mestský úrad.

ZA POPOLNE REZULTATE

Zahvaljujemo se vam, da ste izbrali ta izdelek AEG. Ustvarili smo ga, da bi vam zagotovili dolgoletno brezhibno delovanje z inovativnimi tehnologijami, ki pomagajo poenostaviti življenje – s funkcijami, ki jih ne morete najti pri običajnih napravah. Prosimo, vzemite si nekaj minut za branje, da ga kar najbolje izkoristite.

Obiščite naše spletno mesto za



Pridobitev nasvetov glede uporabe, brošure, odpravljanje težav, servisne informacije in informacije glede popravil:

www.aeg.com/support



Registrirajte izdelek za večjo uporabnost:

www.registreaeg.com



Kupite dodatno opremo, potrošno blago in originalne nadomestne dele za vašo napravo:

www.aeg.com/shop



Za več receptov, namigov in odpravljanje težav prenesite aplikacijo **My AEG Kitchen**.



SKRIB ZA STRANKE IN SERVIS

Vedno uporabite samo originalne rezervne dele.

Ko kličete servis, imejte pri roki naslednje podatke: Model, številka izdelka, serijska številka.

Podatke najdete na ploščici za tehnične navedbe.

 Opozorilo / varnostne informacije

 Splošni podatki in nasveti

 Informacije o varovanju okolja

Pridržujemo si pravico do sprememb.

KAZALO

1. VARNOSTNE INFORMACIJE.....	441	3. OPIS IZDELKA.....	446
1.1 Varnost otrok in ranljivih oseb.....	441	3.1 Splošni pregled.....	447
1.2 Splošna varnost.....	442	3.2 Dodatna oprema.....	447
2. VARNOSTNA NAVODILA.....	443	4. ZA VKLOP IN IZKLOP PEČICE.....	448
2.1 Montaža.....	443	4.1 Gumbi, ki jih lahko potisnete	
2.2 Električne povezave.....	444	nazaj.....	448
2.3 Uporaba.....	444	4.2 Upravljalna plošča.....	448
2.4 Vzdrževanje in čiščenje.....	445	5. PRED PRVO UPORABO.....	449
2.5 Pirolytično čiščenje.....	445	5.1 Začetno čiščenje.....	449
2.6 Notranja osvetlitev.....	446	5.2 Začetno predgrevanje.....	450
2.7 Servis.....	446		
2.8 Odstranjevanje.....	446		

6. VSAKODNEVNA UPORABA.....	450	11. VZDRŽEVANJE IN ČIŠČENJE.....	465
6.1 Nastavitev: Funkcije pečice.....	450	11.1 Opombe glede čiščenja.....	466
6.2 Funkcije pečice.....	451	11.2 Postopek čiščenja: Izboklina	
6.3 Opombe glede: Vlažno pečenje...452		pečice.....	466
6.4 Nastavitev: Kuharski pomočnik...452		11.3 Odstranjevanje: nosilec rešetk	466
6.5 Kuharski pomočnik z recepti.....	453	11.4 Uporaba: Pirolitično čiščenje.....	467
7. ČASOVNE FUNKCIJE.....	458	11.5 Opomnik za čiščenje.....	468
7.1 Časovne funkcije.....	458	11.6	
7.2 Nastavitev: Časovne funkcije.....	459	Odstranjevanje in nameščanje: vrat..	468
8. UPORABA: PRIPOMOČKOV.....	460	11.7 Zamenjava: Luči.....	469
8.1 Vstavljanje opreme.....	460	12. ODPRAVLJANJE TEŽAV.....	470
9. DODATNE FUNKCIJE.....	461	12.1 Kaj storite v primeru	470
9.1 Ključavnica.....	461	12.2 Servisni podatki.....	472
9.2 Samodejni izklop.....	462	13. ENERGIJSKA UČINKOVITOST.....	472
9.3 Ventilator za hlajenje.....	462	13.1 Informacije o izdelku in	
10. NAMIGI IN NASVETI.....	462	informacijski list o izdelku*.....	472
10.1 Vlažno pečenje.....	462	13.2 Varčevanje z energijo.....	473
10.2 Vlažno pečenje -		14. STRUKTURA MENIJA.....	473
priporočeni pripomočki.....	463	14.1 Meni.....	473
10.3 Razpredelnice za pečenje za			
preizkuševalne inštitute.....	463		

1. ⚠ VARNOSTNE INFORMACIJE

Pred namestitvijo in uporabo naprave natančno preberite priložena navodila. Proizvajalec ni odgovoren za poškodbe ali škodo, nastalo zaradi nepravilne namestitve ali uporabe. Navodila vedno shranite na varnem in dostopnem mestu za poznejšo uporabo.

1.1 Varnost otrok in ranljivih oseb

- To napravo lahko otroci od osmega leta naprej ter osebe z zmanjšanimi telesnimi, čutnimi ali razumskimi sposobnostmi ali s pomanjkanjem izkušenj ter znanja uporabljajo le pod nadzorom ali če so dobile ustrezna navodila glede varne uporabe naprave in če se zavedajo nevarnosti, ki obstajajo. Otroci, mlajši od osem (8) let, ter osebe z visoko stopnjo invalidnosti se ne smejo približevati napravi, če niso pod nenehnim nadzorom.

- Otroci morajo biti pod nadzorom, da se ne igrajo z napravo.
- Vso embalažo hranite zunaj dosega otrok in jo ustrezno zavržite.
- **OPOZORILO:** Ko naprava deluje ali se ohlaja, poskrbite, da so otroci in hišni ljubljenci dovolj oddaljeni od naprave. Dostopni deli se med uporabo segrejejo.
- Če je naprava opremljena z zaščito za otroke, mora biti zaščita vklopljena.
- Otroci ne smejo izvajati čiščenja in uporabniškega vzdrževanja naprave, če ni zagotovljen nadzor.

1.2 Splošna varnost

- Nameščanje naprave in zamenjavo kabla lahko opravi le strokovno usposobljena oseba.
- Ne uporabljajte, preden jo namestite v vgrajeno strukturo.
- Pred vzdrževalnimi deli napravo odklopite iz napajanja.
- Če je napajalni kabel poškodovan, ga mora zamenjati predstavnik proizvajalca, pooblaščenega servisnega centra ali druga strokovno usposobljena oseba, da se izognete nevarnosti električnega udara.
- **OPOZORILO:** Pred zamenjavo žarnice mora biti naprava izklopljena, da preprečite možnost udara električnega toka.
- **OPOZORILO:** Naprava in dostopni deli se med uporabo segrejejo. Pazite, da se ne dotaknete grelcev.
- Pripomočke ali posodo vedno odstranjujte iz pečice ali postavljajte vanjo z zaščitnimi rokavicami.
- Za odstranitev nosilcev rešetk najprej povlecite sprednji del nosilcev rešetk in nato zadnjega od stranskih sten. Nosilce rešetk namestite v obratnem zaporedju.
- Naprave ne čistite s paro.
- Za čiščenje steklenih vrat ne uporabljajte grobih čistilnih sredstev ali ostrega kovinskega strgala, da ne poškodujete stekla.

- Pred pirolitičnim čiščenjem je treba odstraniti razlito tekočino. Iz pečice odstranite vse dele.

2. VARNOSTNA NAVODILA

2.1 Montaža



OPOZORILO!

To napravo lahko namesti le strokovno usposobljena oseba.

- Odstranite vso embalažo.
- Ne nameščajte ali uporabljajte poškodovane naprave.
- Upoštevajte navodila za namestitev, priložena napravi.
- Pri premikanju naprave bodite pazljivi, ker je težka. Vedno uporabljajte zaščitne rokavice in priloženo obutev.
- Naprave ne vlecite za ročaj.
- Napravo namestite na varno in primerno mesto, ki ustreza zahtevam za namestitev.
- Upoštevajte predpisano najmanjšo razdaljo do drugih naprav in enot.
- Pred namestitvijo pečice preverite, ali se vrata neovirano odpirajo.
- Naprava je opremljena z električnim hladilnim sistemom. Za krmiljenje slednjega je potrebno električno napajanje.
- Vgrajena enota mora ustrezati zahtevam glede stabilnosti standarda DIN 68930.

Najmanjša višina omarice (najmanjša višina omarice pod delovno površino)	578 (600) mm
Širina omarice	560 mm
Globina omarice	550 (550) mm
Višina sprednjega dela naprave	594 mm
Višina hrbtnege dela naprave	576 mm
Širina sprednjega dela naprave	595 mm
Širina hrbtnege dela naprave	559 mm
Globina naprave	567 mm
Vgradna globina naprave	546 mm
Globina ob odprtih vratih	1027 mm
Najmanjša velikost prezračevalne odprtine. Odprti-na na dnu hrbtne strani	560 x 20 mm

Dolžina napajalnega kabla. Kabel je v desnem vogalu na hrbtni strani	1500 mm
Pritrdilni vijaki	4 x 25 mm

2.2 Električne povezave



OPOZORILO!

Nevarnost požara in električnega udara.

- Električno priključitev mora opraviti usposobljen električar.
- Naprava mora biti ozemljena.
- Preverite, ali so parametri s ploščice za tehnične navedbe združljivi z električno napetostjo omrežja.
- Vedno uporabite pravilno nameščeno varnostno vtičnico.
- Ne uporabljajte razdelilnikov in podaljškov.
- Pazite, da ne poškodujete vtiča in kabla. Če je treba kabel zamenjati, mora to storiti osebje pooblaščenega servisnega centra.
- Priključni kabli ne smejo priti v stik ali bližino vrat naprave ali odprtine pod napravo, še posebej, ko naprava deluje ali so vrata vroča.
- Zaščita pred udarom električnega toka izoliranih delov in delov pod električno napetostjo mora biti pritrjena tako, da je ni mogoče odstraniti brez orodja.
- Vtič vtaknite v vtičnico šele ob koncu nameščanja. Poskrbite, da bo vtič dosegljiv tudi po namestitvi.
- Če je omrežna vtičnica zrahljana, ne vtikajte vtiča.
- Ne vlecite za električni priključni kabel, če želite izključiti napravo. Vedno povlecite za vtič.
- Uporabite le prave izolacijske naprave: odklopnike, varovalke (talilne varovalke odvijte iz nosilca), zaščitne naprave na diferenčni tok in kontaktorje.
- Električna napeljava mora imeti izolacijsko napravo, ki omogoča odklop naprave z omrežja na vseh polih. Izolacijska naprava mora imeti med posameznimi kontakti minimalno razdaljo 3 mm.
- Preden vtaknete vtič v vtičnico, povsem zaprite vrata naprave.
- Ta naprava je dobavljena z vtičem in napajalnim kablom.

2.3 Uporaba



OPOZORILO!

Nevarnost poškodbe, opeklin in električnega udara ali eksplozije.

- Naprava je namenjena samo za (notranjo) uporabo v gospodinjstvu.
- Ne spreminjajte specifikacij te naprave.
- Prepričajte se, da prezračevalne odprtine niso ovirane.
- Naprave med delovanjem ne puščajte brez nadzora.
- Po vsaki uporabi izklopite napravo.
- Pri odpiranju vrat naprave, medtem ko je naprava v uporabi, bodite previdni. Lahko pride do izpusta vročega zraka.
- Naprave se ne dotikajte z mokrimi rokami, ali kadar je v stiku z vodo.
- Ne pritiskajte odprtih vrat.

- Naprave ne uporabljajte kot delovno površino ali površino za odlaganje.
- Previdno odprite vrata naprave. Uporaba sestavin z alkoholom lahko povzroči mešanico alkohola in zraka.
- Ne dovolite, da bi iskre ali odprti plameni prišli v stik z napravo, ko odprete vrata.
- Ne postavljajte vnetljivih izdelkov ali predmetov, ki so prepojeni z vnetljivimi izdelki, v napravo, blizu nje ali nanjo.



OPOZORILO!

Obstaja nevarnost škode na napravi.

- Za preprečevanje poškodb ali razbarvanja emajla:
 - Ne smete postaviti pekačev ali drugih predmetov neposredno na dno naprave.
 - Ne smete postaviti aluminijaste folije neposredno na dno naprave.
 - Ne smete postaviti vode neposredno v vročo napravo.
 - Ne smete hraniti vlažnih jedi in hrane v napravi, potem ko nehate kuhati.
 - Pri odstranjevanju ali nameščanju opreme bodite previdni.
- Sprememba barve emajla ali nerjavnega jekla ne vpliva na zmogljivost naprave.
- Za vlažno pecivo uporabite globok pekač. Sadni sokovi povzročijo madeže, ki so lahko trajni.
- Ta naprava je namenjena le kuhanju. Ne smete je uporabljati v druge namene, denimo za ogrevanje prostorov.
- Vedno kuhajte z zaprtimi vrati pečice.
- Če napravo namestite za ploščo omarice (npr. vrata), poskrbite, da vrata med delovanjem naprave ne bodo nikoli zaprta. Za zaprto ploščo omarice se lahko nakopičita toplota in vlaga ter povzročita nadaljnje poškodbe naprave, ohišja ali tal. Plošče omarice ne zapirajte, dokler se po uporabi naprava popolnoma ne ohladi.

2.4 Vzdrževanje in čiščenje



OPOZORILO!

Nevarnost telesnih poškodb, požara ali poškodb naprave.

- Pred vzdrževanjem izklopite napravo in iztahnite vtič iz vtičnice.
- Prepričajte se, da je naprava hladna. Vroče steklene plošče lahko počijo.
- Ko se steklene plošče v vratih poškodujejo, jih takoj zamenjajte. Obrnite se na pooblaščen servisni center.
- Ob odstranjevanju vrat z naprave bodite previdni. Vrata so težka!
- Napravo redno čistite, da preprečite poškodbe materiala na površini.
- Napravo očistite z vlažno mehko krpo. Uporabljajte samo nevtralna čistilna sredstva. Za čiščenje ne uporabljajte abrazivnih čistil, grobih gobic, topil ali kovinskih predmetov.
- Če uporabljate razpršilo za čiščenje pečice, upoštevajte varnostna navodila z embalaže.

2.5 Pirolitično čiščenje



OPOZORILO!

Nevarnost poškodb/Požara/Kemičnih emisij (hlapov) v načinu Piroliza.

- Pred izvajanjem funkcije samodejnega čiščenja s pirolizo ali pred prvo uporabo iz pečice odstranite:
 - Vse odvečne ostanke hrane, razlito olje ali maščobo/obloge.
 - Vse odstranljive predmete (vključno z rešetkami, stranskimi vodili itd., ki so priloženi izdelku), še posebej lonce, ponve, pekače, posode s premazom proti prijemanju itd.
- Pazljivo preberite vsa navodila za pirolitično čiščenje.

- Med pirolitičnim čiščenjem naj se otroci ne zadržujejo v bližini naprave. Naprava se močno segreje, iz sprednjih hladilnih odprtin pa se sprošča vroč zrak.
- Pri pirolitičnem čiščenju so prisotne visoke temperature, zaradi katerih se lahko iz ostankov hrane in konstrukcijskega materiala kadi, takrat uporabniku močno priporočamo, da naredi naslednje:
 - Med in po vsakem pirolitičnem čiščenju poskrbi za dobro prezračevanje.
 - Med prvo uporabo pri najvišji temperaturi in po njej zagotovi dobro prezračevanje.
- Za razliko od ljudi so nekateri ptiči in plazilci lahko izredno občutljivi na morebitne hlapce, ki se sproščajo med čiščenjem pirolitičnih pečic.
 - Med in po pirolitičnem čiščenju umaknite živali (še posebej ptice) iz okolice naprave, prostor pa naj bo po čiščenju ob prvi uporabi pečice pri najvišji temperaturi dobro prezračevan.
- Majhne domače živali so prav tako lahko občutljive na krajevne temperaturne spremembe v bližini vseh pirolitičnih pečic med izvajanjem programa samodejnega pirolitičnega čiščenja.
- Površine proti prijemanju na loncih, ponvah, pekačih, posodah itd. lahko poškodujejo visoke temperature pri pirolitičnem čiščenju vseh pirolitičnih pečic in so lahko tudi vir nizke stopnje škodljivih hlapov.
- Hlapi, ki se sproščajo iz pirolitičnih pečic/ostankov hrane, kot je opisano, niso škodljivi za ljudi, vključno z otroki ali osebami z zdravstvenimi težavami.

2.6 Notranja osvetlitev



OPOZORILO!

Nevarnost električnega udara.

- O žarnicah v izdelku in nadomestnih žarnicah, ki se prodajajo ločeno: Te žarnice so zasnovane za ekstremne pogoje v gospodinjskih aparatih, kot so izjemne temperature, vibracije in vlažnosti, ali za sporočanje informacij o delovanju aparata. Niso namenjene za uporabo drugje in niso primerne za sobno razsvetljavo v gospodinjstvu
- Uporabite le žarnice z istimi specifikacijami.

2.7 Servis

- Za popravilo naprave se obrnite na pooblaščen servisni center.
- Uporabljajte samo originalne nadomestne dele.

2.8 Odstranjevanje



OPOZORILO!

Nevarnost poškodbe ali zadušitve.

- Napravo izključite iz napajanja.
- Odrežite električni priključni kabel tik ob napravi in napravo zavržite.
- Odstranite zapah in na ta način preprečite, da bi se otroci ali živali zaprli v napravo.

3. OPIS IZDELKA

3.1 Splošni pregled

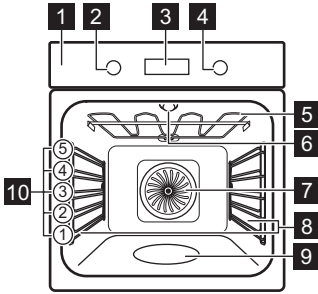

- 1** Upravljalna plošča
- 2** Gumb za funkcije pečice
- 3** Prikazovalnik
- 4** Upravljalni gumb
- 5** Grelnik
- 6** Luč
- 7** Ventilator
- 8** Nosilec police, snemljiv
- 9** Položaji polic
- 10** Vboklina pečice

3.2 Dodatna oprema

Mreža za pečenje

Za posode za kuhanje, pekače za pecivo, pečenke.

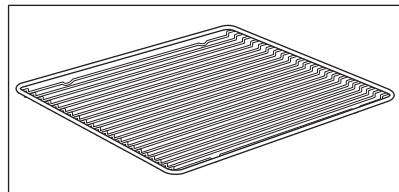

Pekač za pecivo

Za pecivo in biskvit.

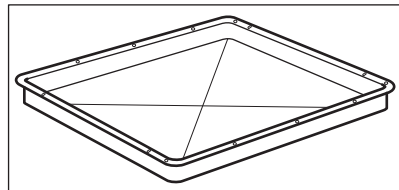

ZA VKLOP IN IZKLOP PEČICE

Posoda za žar/pekač

Za peko in praženje, ali kot posoda za zbiranje maščobe.

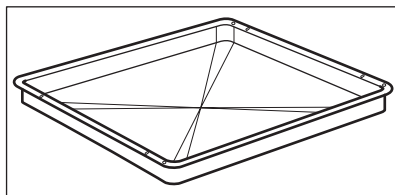

Teleskopska vodila

Za preprostejše vstavljanje in odstranjevanje pekačev in rešetke.

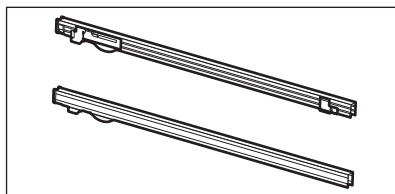







4. ZA VKLOP IN IZKLOP PEČICE

4.1 Gumbi, ki jih lahko potisnete nazaj

Za uporabo naprave pritisnite gumb. Gumb izskoči.

4.2 Upravljalna plošča

Senzorska polja nadzorne plošče					Pritiskajte	Obrnite gumb
 Časovnik	 Hitro se- grevanje pečice	 Osve- tlitev	 Ključavnica	OK		







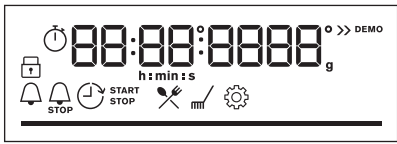

Izberite funkcijo pečice, da izklopite pečico.

Gumb za funkcije pečice obrnite v položaj za izklop, da izklopite pečico.

	Ko je gumb za funkcije pečice v položaju za izklop, prikazovalnik preklopi v stanje pripravljenosti.
---	--

	<p>Med pečenjem se na prikazovalniku prikažejo nastavljena temperatura, ura in druge razpoložljive možnosti.</p>
	<p>Prikazovalnik z največjim številom nastavljenih funkcij.</p>

Indikatorji prikazovalnika

 Ključavnica	 Kuharski pomočnik	 Čiščenje	 Nastavitve	 Hitro segrevanje pečice
Indikatorji programske ure:				





<p>Vrstica napredovanja – za temperaturo ali uro.</p>	
---	---

<p>Indikator pečenja s paro</p>	
---------------------------------	---

5. PRED PRVO UPORABO

 <p>OPOZORILO! Oglejte si poglavja o varnosti.</p>

5.1 Začetno čiščenje

<p>Pred prvo uporabo očistite prazno pečico in nastavite čas:</p>			
			 00:00 Nastavite programsko uro. Pritisnite OK.

VSAKODNEVNA UPORABA

5.2 Začetno predgrevanje



Pred prvo uporabo prazno pečico predhodno ogrevajte.

1. korak:

Iz pečice odstranite vso opremo in odstranljive nosilce rešetk.

2. korak:

Nastavite najvišjo temperaturo za funkcijo: .
Pečica naj deluje eno uro.

3. korak:

Nastavite najvišjo temperaturo za funkcijo: .
Pečica naj deluje 15 minut.

 Pečica lahko med predgrevanjem oddaja neprijetne vonjave in dim. Poskrbite za prezračevanje prostora.

6. VSAKODNEVNA UPORABA



OPOZORILO!

Oglejte si poglavja o varnosti.

6.1 Nastavitev: Funkcije pečice

Začetek pečenja

1. korak



Nastavitev funkcije pečice.

2. korak



Nastavite temperaturo.

Priprava jedi s paro

Prepričajte se, da je pečica hladna.



1. korak

2. korak

3. korak

4. korak

Priprava jedi s paro



						<p>Predhodno segrevajte prazno pečico 10 minut, da ustvarite vlago. Postavite hrano v pečico.</p>
<p>Vboklino pečice napolnite z vodo iz pipe.</p>	<p>Nastavite funkcijo gretja s paro.</p>	<p>Nastavite temperaturo.</p>				
<p>i V vboklino pečice lahko natočite največ 250 ml. Vbokline pečice ne polnite ponovno med peko ali ko je pečica vroča.</p>						







Ko se pečenje s paro konča:

1. korak	2. korak	3. korak
<p>Gumb za funkcije pečice obrnite v položaj za izklop za izklop pečice.</p>	<p>Previdno odprite vrata. Sproščena vlaga lahko povzroči opekline.</p>	<p>Prepričajte se, da je pečica hladna. Iz vbokline pečice odstranite preostalo vodo.</p>

6.2 Funkcije pečice

Standardne funkcije pečice

Funkcija pečice	Aplikacija
 <p>Vroči zrak</p>	<p>Za sočasno pečenje na do treh višinah pečice in sušenje živil. Temperaturo nastavite za 20–40 °C nižje kot pri funkciji Gretje zgoraj/spodaj.</p>
 <p>Gretje zgoraj/spodaj</p>	<p>Za peko in pečenje mesa na enem položaju rešetke.</p>
 <p>SteamBake</p>	<p>Za dodajanje vlage med pripravo hrane. Zagotovite pravo barvo in hrustljivo skorjo med pečenjem. Za večjo sočnost med pogrevanjem. Za ohranjanje sadja ali zelenjave.</p>

Funkcija pečice	Aplikacija
 <p>Pizza funkcija</p>	Za peko pizze. Za močno zapečenost in hrustljivo dno.
 <p>Gretje spodaj</p>	Za peko tort s hrustljivim dnom in da se hrana ne pokvari.
 <p>Zamrznjene jedi</p>	Za hrustljave pripravljene jedi (npr. ocvrti krompir, pečen krompir v oblikah ali spomladanski zvitki).
 <p>Vlažno pečenje</p>	Ta funkcija je zasnovana za varčevanje z energijo med pečenjem. Ko uporabljate to funkcijo, se lahko temperatura v pečici razlikuje od nastavljene. Uporabljena je akumulirana toplota. Moč segrevanja se lahko zmanjša. Za dodatne informacije si oglejte poglavje »Dnevna uporaba«, Opombe: Vlažno pečenje.
 <p>Žar</p>	Za pečenje tankih živil na žaru in popekanje kruha.
 <p>Infra pečenje</p>	Za pečenje velikih kosov mesa ali perutnine s kostmi na eni višini. Za gratiniranje in dodatno zapečenost.
 <p>Meni</p>	Za vstop v meni: Kuharski pomočnik, Čiščenje, Nastavitve.

6.3 Opombe glede: Vlažno pečenje

Ta funkcija je bila uporabljena za skladnost z razredom energijske učinkovitosti in zahtevami glede okoljske primernosti v skladu z EU 65/2014 in EU 66/2014. Preizkusi v skladu z EN 60350-1.





Med pečenjem morajo biti vrata pečice zaprta, da se funkcija ne prekine in pečica deluje z največjo energijsko učinkovitostjo.

Ko uporabljate to funkcijo, luč po 30 sekundah samodejno ugasne.



Za navodila za kuhanje si oglejte poglavje »Namigi in nasveti«, Vlažno pečenje. Za splošna priporočila za varčevanje z energijo si oglejte poglavje »Energijska učinkovitost«, Varčevanje z energijo.

6.4 Nastavitev: Kuharski pomočnik



Vsaka jed v tem podmeniju ima priporočeno funkcijo in temperaturo. Čas in temperaturo lahko nastavite med pečenjem.

Kuharski pomočnik – uporabite ga za hitro pripravo s privzetimi nastavitvami:			
1. korak	2. korak	3. korak	4. korak
 	 	 1 - 45	 OK
Vstopite v meni.	Izberite Kuharski pomočnik. Pritisnite OK.	Izberite jed. Pritisnite OK.	Vstavite jed v pečico. Potrdite nastavitvev.





6.5 Kuharski pomočnik z recepti











Legenda	
	Količina vode za funkcijo s paro.
	Preden začnete peči, predhodno ogrejte pečico.
	Višina rešetke.

Ko se funkcija konča, preverite, ali je hrana pripravljena.













	Jed	Teža	Višina rešetke / dodatna oprema	Čas trajanja
Govedina 				
P1	Goveja pečenka, manj pečena	1–1,5 kg; 4–5 cm debeli kosi	 2; pekač za pecivo Nekaj minut pražite meso v vroči posodi. Vstavite v pečico.	40 min
P2	Goveja pečenka, srednje pečena			50 min
P3	Goveja pečenka, dobro pečena			60 min





















VSAKODNEVNA UPORABA

	Jed	Teža	Višina rešetke / dodatna oprema	Čas trajanja
P4	Zrezek, srednje pečen	180–220 g na kos; 3 cm debele rezine	  3; posoda za pečenje na mreži za pečenje Nekaj minut pražite meso v vroči posodi. Vstavite v pečico.	15 min
P5	Pečena/dušena govedina (bržolna pečenka, notranje stegno, debela potrebušina)	1,5–2 kg	 2; posoda za pečenje na mreži za pečenje Nekaj minut pražite meso v vroči posodi. Dodajte tekočino. Vstavite v pečico.	120 min
P6	Goveja pečenka, manj pečena (pečenje z nizko temp.)	1–1,5 kg; 4–5 cm debeli kosi	 2; pekač za pecivo Uporabite vaše priljubljene začimbe ali preprosto sol in sveže mleti poper. Nekaj minut pražite meso v vroči posodi. Vstavite v pečico.	75 min
P7	Goveja pečenka, srednje pečena (pečenje z nizko temp.)			85 min
P8	Goveja pečenka, bolj pečena (pečenje z nizko temp.)			130 min
P9	File, manj pečen (pečenje z nizko temp.)	0,5–1,5 kg; 5–6 cm debeli kosi	 2; pekač za pecivo Uporabite vaše priljubljene začimbe ali preprosto sol in sveže mleti poper. Nekaj minut pražite meso v vroči posodi. Vstavite v pečico.	75 min
P10	File, srednje pečen (pečenje z nizko temp.)			90 min
P11	File, dobro pečen (pečenje z nizko temp.)			120 min





















	Jed	Teža	Višina rešetke / dodatna oprema	Čas trajanja
Teletina 				
P12	Telečja pečenka (npr. pleče)	0,8–1,5 kg; 4 cm debeli kosi	 2 ; posoda za pečenje na mreži za pečenje Uporabite vaše priljubljene začimbe. Dodajte tekočino. Pecite pokrito.	80 min
Svinjina  				
P13	Pečen svinjski vrat ali pleče	1,5–2 kg	 2 ; posoda za pečenje na mreži za pečenje Po polovici časa pečenja meso obrnite.	120 min
P14	Natrgana svinjina LTC	1,5–2 kg	 2 ; pekač za pecivo Uporabite vaše priljubljene začimbe. Po polovici časa pečenja meso obrnite, da se enakomerno zapeče.	215 min
P15	Ledvena pečenka, sveža	1–1,5 kg; 5–6 cm debeli kosi	 2 ; posoda za pečenje na mreži za pečenje Uporabite vaše priljubljene začimbe.	55 min
P16	Rebrca	2–3 kg; uporabite surova, 2–3 cm tanka rebrca	 3 ; globok pekač Dodajte tekočino, da prekrijete spodnji del jedi. Po polovici časa pečenja meso obrnite.	90 min
Jagnjetina 				
P17	Jagnečje stegno s kostmi	1,5–2 kg; 7–9 cm debeli kosi	 2 ; posoda za pečenje na pekaču za pecivo Dodajte tekočino. Po polovici časa pečenja meso obrnite.	130 min
Perutnina 				

VSAKODNEVNA UPORABA

	Jed	Teža	Višina rešetke / dodatna oprema	Čas trajanja
P18	Cel piščanec	1–1,5 kg; svež	 2;  200 ml; kozica na pekaču za pecivo Uporabite vaše priljubljene začimbe. Po polovici časa pečenja piščanca obrnite, da se enakomerno zapeče.	60 min
P19	Piščanec, polovica	0,5–0,8 kg	 3; pekač za pecivo Uporabite vaše priljubljene začimbe.	40 min
P20	Piščančje prsi	180–200 g na kos	  2; kozica na mreži za pečenje Uporabite vaše priljubljene začimbe. Nekaj minut pražite meso v vroči posodi.	25 min
P21	Piščančja bedra, sveža	-	 3; pekač za pecivo Če ste piščančja bedra marinirali, nastavite nižjo temperaturo in jih pecite dlje.	30 min
P22	Raca, cela	2–3 kg	 2; posoda za pečenje na mreži za pečenje Uporabite vaše priljubljene začimbe. Postavite meso v posodo za pečenje. Po polovici časa pečenja raco obrnite.	100 min
P23	Gos, cela	4–5 kg	 2; globok pekač Uporabite vaše priljubljene začimbe. Postavite meso na globok pekač. Po polovici časa pečenja gos obrnite.	110 min
Ostalo 				
P24	Mesna štruca	1 kg	 2; mreža za pečenje Uporabite vaše priljubljene začimbe.	60 min
 Ribe				
P25	Cela riba, pečena na žaru	0,5–1 kg na ribo	 2; pekač za pecivo Napolnite ribo z maslom in uporabite vaše priljubljene začimbe in zelišča.	30 min

	Jed	Teža	Višina rešetke / dodatna oprema	Čas trajanja
P26	Ribji file	-	  3; kozica na mreži za pečenje Uporabite vaše priljubljene začimbe.	20 min.
Kolači / sladice   				
P27	Skutna torta	-	 2; \varnothing 28 cm model za pečenje s snemljivim obodom na mreži za pečenje	90 min
P28	Jabolčni kolač	-	 2;  100–150 ml; pekač za pecivo	60 min
P29	Jabolčna pita	-	 2; model za pito na mreži za pečenje	40 min
P30	Jabolčna pita	-	 2;  100–150 ml; \varnothing 22 cm model za pito na mreži za pečenje	60 min
P31	Čokoladni kolač z lešniki	2 kg	 3; globok pekač	30 min
P32	Čokoladni muffini	-	 2;  100–150 ml; pekač za muffine na mreži za pečenje	30 min
P33	Biskvitno pecivo	-	 2; model za kruh na mreži za pečenje	50 min
Zelenjava/priloge   				
P34	Pečen krompir	1 kg	 2; pekač za pecivo Postavite cele neolupljene krompirje na pekač za pecivo.	50 min
P35	Pečeni krompir v oblicah	1 kg	 3; pekač za pecivo, obdan s papirjem za peko Uporabite vaše priljubljene začimbe. Narežite krompir na kose.	35 min
P36	Mešana zelenjava na žaru	1–1,5 kg	 3; pekač za pecivo, obdan s papirjem za peko Uporabite vaše priljubljene začimbe. Narežite zelenjavo na kose.	30 min



ČASOVNE FUNKCIJE

	Jed	Teža	Višina rešetke / dodatna oprema	Čas trajanja
P37	Kroketi, zamrznjeni	0,5 kg	 3; pekač za pecivo	25 min
P38	Ocvrt krompir, zamrznjen	0,75 kg	 3; pekač za pecivo	25 min
Gratiniranje, kruh in pizza   				
P39	Lazanja / zloženska iz re-zancev	1–1,5 kg	 2; kozica na mreži za pečenje	45 min.
P40	Gratiniran krompir	1–1,5 kg	 1; kozica na mreži za pečenje	50 min
P41	Sveža pizza, tanka	-	  2;  100 ml; pekač za pecivo, obdan s papirjem za peko	15 min.
P42	Sveža pizza, debela	-	  2;  100 ml; pekač za pecivo, obdan s papirjem za peko	25 min
P43	Kiš	-	 2; model za pečenje na mreži za pečenje	45 min.
P44	Francoske štručke / ciabatta / beli kruh	0,8 kg	  3;  150 ml; pekač za pecivo, obdan s papirjem za peko Več časa, potrebnega za beli kruh.	30 min
P45	Polnozrnat/rženi/črni kruh v modelu za kruh	1 kg	  2;  150 ml; pekač za pecivo, obdan s papirjem za peko / mreža za pečenje	45 min.



7. ČASOVNE FUNKCIJE







7.1 Časovne funkcije

Časovna funkcija	Aplikacija
	Odštevalna ura. Ko se programska ura izteče, se oglasi zvočni signal.







Časovna funkcija	Aplikacija
	Čas priprave. Ko se programska ura izteče, se oglasi zvočni signal, funkcija pečice pa se izklopi.
	Zamik vklopa. Za zamik začetka in/ali konca pečenja.
	Čas delovanja. Največ je 23 ur in 59 minut. Ta funkcija ne vpliva na delovanje pečice. Za vklop in izklop Čas delovanja izberite: Meni, Nastavitve.

7.2 Nastavitev: Časovne funkcije

Nastavitev: Ura		
1. korak	2. korak	3. korak
		
Za spremembo ure vstopite v meni in izberite Nastavitve, Ura.	Nastavite uro.	Pritisnite: OK.

Nastavitev: Odštevalna ura			
1. korak	Na prikazovalniku se prikaže: 0:00 	2. korak	3. korak
			
Pritisnite:  .	Nastavite Odštevalna ura	Pritisnite: OK.	
 Programska ura začne takoj odštevati čas.			

UPORABA: PRIPOMOČKOV

Nastavitev: Čas priprave				
1. korak	2. korak	Na prikazovalniku se prikaže: 0:00  STOP	3. korak	4. korak
				
Izberite funkcijo pečice in nastavite temperaturo.	Ponavljajoče pritisnite:  .		Nastavite čas kuhanja.	Pritisnite: OK.
 Programska ura začne takoj odšteti čas.				

Nastavitev: Zamik vklopa							
1. korak	2. korak	Na prikazovalniku se prikaže: ura  ZAČETEK	3. korak	4. korak	Na prikazovalniku se prikaže: --:--  ZAUSTAVITEV	5. korak	6. korak
							
Izberite funkcijo pečice.	Ponavljajoče pritisnite:  .		Nastavite začetni čas.	Pritisnite: OK.		Nastavite končni čas.	Pritisnite: OK.
 Programska ura začne odšteti čas ob nastavljenem začetnem času.							

8. UPORABA: PRIPOMOČKOV

8.1 Vstavljanje opreme

Majhna zarez na vrhu poveča varnost. Zareze so tudi varovala pred prevračanjem. Visok rob okrog mreže preprečuje zdrs posode.

Mreža za pečenje:

Mrežo potisnite med vodili nosilca rešetk .

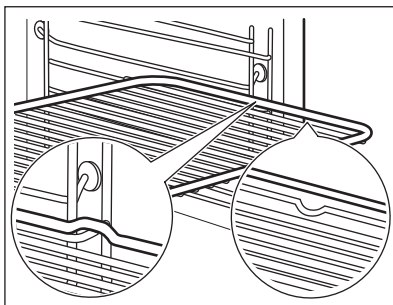

Pekač za pecivo /Globok pekač:

Pekač potisnite med vodili nosilca rešetk.

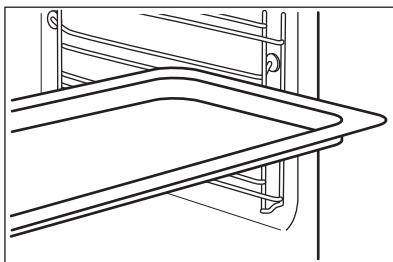

Mreža za pečenje, Pekač za pecivo /Globok pekač:

Pekač potisnite med vodili nosilca rešetk in mrežo za pečenje na vodilih zgoraj.

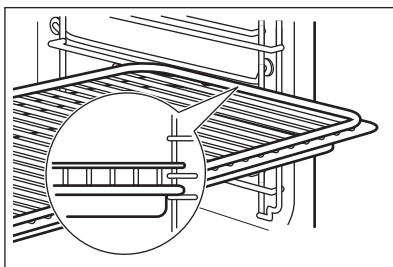

9. DODATNE FUNKCIJE

9.1 Ključavnica

Ta funkcija preprečuje nenamerno spremembo funkcije pečice.

Vklopite jo, ko pečica deluje – nastavljeno pečenje se nadaljuje, nadzorna plošča je zaklenjena.
 Vklopite jo, ko je pečica izklopljena – pečice ni mogoče vklopiti, nadzorna plošča je zaklenjena.

NAMIGI IN NASVETI

Ta funkcija preprečuje nenamerno spremembo funkcije pečice.





 - pritisnite in držite za vklop funkcije.
Oglasi se zvočni signal.

 - pritisnite in držite, da jo izklopite.

 3 x  - utripne, ko je zapora vklopljena.

9.2 Samodejni izklop

Iz varnostnih razlogov se pečica po določenem času izklopi, če deluje funkcija pečice in ne spremenite nastavitvev.

 (°C)	 (h)
30 - 115	12.5
120 - 195	8.5
200 - 245	5.5
250 - maksimalno	3

Samodejni izklop ne deluje pri naslednjih funkcijah: Osvetlitev, Zamik vklopa.



9.3 Ventilator za hlajenje



Ko pečica deluje, se samodejno vklopi ventilator za hlajenje, ki ohranja površine pečice hladne. Če pečico izklopite, lahko ventilator za hlajenje še naprej deluje, dokler se pečica ne ohladi.

10. NAMIGI IN NASVETI

10.1 Vlažno pečenje



Za najboljše rezultate upoštevajte priporočila, navedena v spodnji razpredelnici. Uporabite tretji položaj rešetk.

	 (°C)	 (min.)
Gratinirane testenine	200 - 220	45 - 55

	 (°C)	 (min.)
Gratiniran krompir	180 - 200	70 - 85
Musaka	170 - 190	70 - 95
Lazanja	180 - 200	75 - 90
Kaneloni	180 - 200	70 - 85
Kruhov narastek	190 - 200	55 - 70
Rižev puding	170 - 190	45 - 60
Jabolčno pecivo iz umešanega testa (okrogel model za pečenje)	160 - 170	70 - 80
Beli kruh	190 - 200	55 - 70

10.2 Vlažno pečenje - priporočeni pripomočki

Uporabite temne in neodbojne pekače in posode. Bolje vsrkavajo toploto od svetlih barvnih in odbojnih posod.

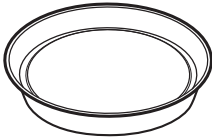
			
Posoda za pico	Pekač za peko	Majhne posodice za pečenje in serviranje	Model za testo za kolač
Temen, neodbojen premer 28 cm	Temen, neodbojen premer 26 cm	Keramika premer 8 cm, višina 5 cm	Temen, neodbojen premer 28 cm

10.3 Razpredelnice za pečenje za preizkuševalne inštitute





Informacije za preizkuševalne inštitute

Preizkusi v skladu z: EN 60350, IEC 60350.

NAMIGI IN NASVETI



PEKA NA ENEM NIVOJU. Peka v modelih





		 (°C)	 (min.)	
Pusti biskvit	Vroči zrak	140 - 150	35 - 50	2
Pusti biskvit	Gretje zgoraj/spodaj	160	35 - 50	2
Jabolčna pita, 2 modela za pečenje Ø 20 cm	Vroči zrak	160	60 - 90	2
Jabolčna pita, 2 modela za pečenje Ø 20 cm	Gretje zgoraj/spodaj	180	70 - 90	1



PEKA NA ENEM NIVOJU. Drobno pecivo







Uporabite tretji položaj rešetk.

		 (°C)	 (min.)
Masleni piškoti / Pecivo iz krhkega testa	Vroči zrak	140	25 - 40
Masleni piškoti / Pecivo iz krhkega testa, predhodno ogrejte prazno pečico	Gretje zgoraj/spodaj	160	20 - 30
Drobno pecivo (20 kosov na pekač), predhodno ogrejte prazno pečico	Vroči zrak	150	20 - 35
Drobno pecivo (20 kosov na pekač), predhodno ogrejte prazno pečico	Gretje zgoraj/spodaj	170	20 - 30

VZDRŽEVANJE IN ČIŠČENJE



PEKA NA VEČ NIVOJIH. Drobno pecivo

		 (°C)	 (min.)	
Masleni piškoti / Pecivo iz krhkega testa	Vroči zrak	140	25 - 45	1 / 4
Drobno pecivo (20 kosov na pekač), predhodno ogrejte prazno pečico	Vroči zrak	150	23 - 40	1 / 4
Pusti biskvit	Vroči zrak	160	35 - 50	1 / 4







ŽAR



Prazno pečico pet minut predhodno segrevajte.



Žar z najvišjo nastavitvijo temperature.

		 (min.)	
Toast	Žar	1 - 3	5
Goveji zrezek, obrnite po polovici časa priprave	Žar	24 - 30	4



11. VZDRŽEVANJE IN ČIŠČENJE



OPOZORILO!

Oglejte si poglavja o varnosti.

11.1 Opombe glede čiščenja

 Čistilna sredstva	Sprednji del pečice očistite z mehko krpo, toplo vodo in blagim čistilom.
	Za čiščenje kovinskih površin uporabite čistilno raztopino.
	Madeže očistite z blagim čistilnim sredstvom.
 Vsakodnevna uporaba	Pečico očistite po vsaki uporabi. Nakopičena maščoba ali drugi ostanki lahko povzročijo požar.
	Hrane ne shranjujte v pečici dlje kot 20 minut. Po vsaki uporabi notranjost posušite z mehko krpo.
 Pripomočki	Vso opremo očistite po vsaki uporabi in pustite, da se posuši. Uporabite mehko krpo s toplo vodo in blago čistilno sredstvo. Pripomočkov ne pomivajte v pomivalnem stroju.
	Pripomočkov s premazom proti prijemanju ne čistite z abrazivnimi čistilnimi sredstvi ali ostrimi predmeti.

11.2 Postopek čiščenja: Izboklina pečice

Po peki s paro očistite vboklino pečice, da odstranite ostanke apnenca.

1. korak	2. korak	3. korak
Vlijte: 250 ml belega kisa v vboklino pečice. Uporabite največ 6-odstotni kis brez dodatkov.	Kis naj 30 minut pri temperaturi okolja raztaplja ostanke apnenca.	Notranjost pečice očistite s toplo vodo in mehko krpo.
Za funkcijo: SteamBake očistite pečico vsakih 5 - 10 ciklov peke.		

11.3 Odstranjevanje: nosilcev rešetk

Pred začetkom čiščenja pečice odstranite nosilce rešetk.

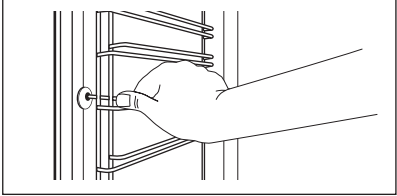
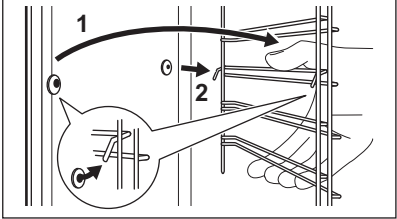
1. korak:	Izklopite pečico in počakajte, da se ohladi.	
2. korak:	Sprednji del nosilca rešetke povlecite stran od stranske stene.	
3. korak:	Zadnji del nosilca rešetke potegnite s stranskih sten in ga odstranite.	
4. korak:	Nosilce rešetk namestite v obratnem zaporedju. Zadrževalni zatiči na teleskopskih vodilih morajo biti obrnjeni naprej.	

11.4 Uporaba: Pirolitično čiščenje

Za čiščenje pečice uporabite Pirolitično čiščenje.



OPOZORILO!

Obstaja tveganje opeklin.



POZOR!

Če v isti kuhinjski element namestite druge naprave, jih ne uporabljajte sočasno s to funkcijo. To lahko poškoduje pečico.



Pred Pirolitično čiščenje:

Izklopite pečico in počakajte, da se ohladi.	Odstranite pripomočke in odstranljive nosilce rešetk.	Dno pečice in notranje steklo vrat očistite s toplo vodo, mehko krpo in blagim čistilnim sredstvom.
--	---	---

Pirolitično čiščenje

1. korak	Odprite meni: Čiščenje m/\cdot .	
Možnost	Trajanje	
C1 - Rahlo čiščenje	1 h	
C2 - Običajno čiščenje	1 h 30 min	

VZDRŽEVANJE IN ČIŠČENJE

Pirolitično čiščenje	
C3 - Temeljito čiščenje	3 h
2. korak	OK – pritisnite za izbiro programa čiščenja.
3. korak	OK – pritisnite za začetek čiščenja.
4. korak	Po čiščenju obrnite gumb za funkcije pečice v položaj za izklop.
 Med čiščenjem luč v pečici ne sveti.	
Ko pečica doseže nastavljeno temperaturo, se vrata zaklenejo. Dokler se vrata ne odklenejo, prikazovalnik prikazuje:  .	



Ko se čiščenje konča:		
Izklopite pečico in počakajte, da se ohladi.	Notranjost pečice očistite z mehko krpo.	Z dna pečice odstranite ostanke.

11.5 Opomnik za čiščenje

Pečica vas opomni, kdaj jo morate očistiti s pomočjo pirolitičnega čiščenja.	
 5 sekund utripa na prikazovalniku po vsakem postopku priprave jedi.	Za izklop opomnika vnesite Meni in izberite Nastavitve, Opomnik za čiščenje.

11.6 Odstranjevanje in nameščanje: vrat

Za čiščenje lahko odstranite vrata in notranje steklene plošče. Število steklenih plošč se razlikuje med modeli.

 OPOZORILO! Vrata so težka.
 POZOR! S steklom ravnajte previdno, zlasti okoli robov sprednje plošče. Steklo lahko počí.

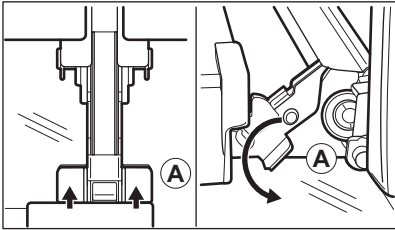
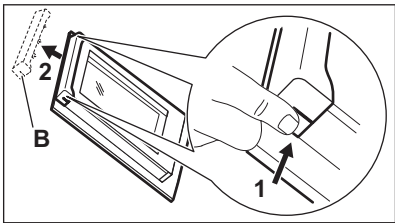
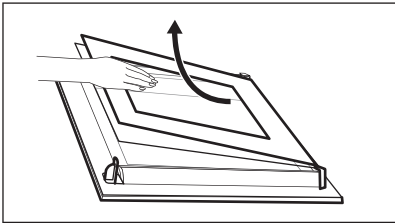
1. korak	Povsem odprite vrata.	
2. korak	Dvignite in pritisnite vpenjalni ročici (A) na tečajih.	
3. korak	Odprite vrata pečice do prvega položaja odpiranja (približno do kota 70°). Vrata držite na obeh straneh in jih potegnite stran od pečice pod kotom navzgor. Nato položite vrata z zunanjo stranjo navzdol na mehko krpo in trdno površino.	
4. korak	Okvir vrat (B) pridržite na njegovem zgornjem robu na obeh straneh in potisnete navznoter, da sprostite tesnilo sponke.	
5. korak	Okvir vrat potegnite k sebi in ga odstranite.	
6. korak	Steklene plošče vrat primite na zgornjem robu eno za drugo in jih potegnite navzgor iz vodila.	
7. korak	Stekleno ploščo očistite z vodo in milom. Stekleno ploščo temeljito osušite. Steklenih plošč ne pomivajte v pomivalnem stroju.	
8. korak	Po čiščenju naredite zgornje korake v obratnem vrstnem redu.	
9. korak	Najprej vstavite manjšo ploščo, nato pa večjo in vrata. Poskrbite, da boste steklene plošče vstavili pravilno, drugače se lahko površina vrat pregreje.	

11.7 Zamenjava: Luči



OPOZORILO!

Nevarnost električnega udara.
Žarnica je lahko vroča.

ODPRAVLJANJE TEŽAV

Pred zamenjavo žarnice:

1. korak:	2. korak:	3. korak:
Izklopite pečico. Počakajte, da se pečica ohladi.	Pečico izključite iz napajanja.	Na dno pečice položite krpo.

Zgornja žarnica

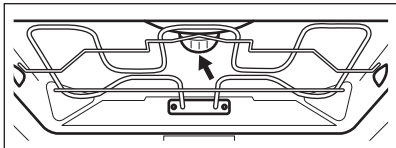
1. korak:	Obrnite steklen pokrov in ga odstranite.	
2. korak:	Očistite steklen pokrov.	
3. korak:	Žarnico zamenjajte z ustrežno žarnico, odporno proti visoki temperaturi 300 °C.	
4. korak:	Namestite steklen pokrov.	

12. ODPRAVLJANJE TEŽAV



OPOZORILO!

Oglejte si poglavja o varnosti.

12.1 Kaj storite v primeru ...

V vseh primerih, ki niso vključeni v to razpredelnico, se obrnite na pooblaščen servisni center.



Pečica se ne vklopi ali segreje

Problem	Preverite naslednje:
Pečice ni mogoče vklopiti ali je uporabljati.	Pečica je pravilno priključena na električno napajanje.
Pečica se ne segreje.	Samodejni izklop je onemogočen.
Pečica se ne segreje.	Vrata pečice so zaprta.



Pečica se ne vklopi ali segreje

Pečica se ne segreje.	Varovalka ni pregorela.
Pečica se ne segreje.	Varovalo za otroke je izklopljeno.



Komponente

Problem	Preverite naslednje:
Luč ne sveti.	Vlažno pečenje – je vklopljeno.
Luč ne deluje.	Luč je pregorela.



Kode napak

Na prikazovalniku se prikaže ...	Preverite naslednje:
Err C3	Vrata pečice so zaprta ali pa zapora vrat ni pokvarjena.
Err F102	Vrata pečice so zaprta.
Err F102	Zapora vrat ni pokvarjena.
00:00	Prišlo je do izpada napajanja. Nastavite uro.

Če se na prikazovalniku prikaže koda napake, ki je ni v razpredelnici, izklopite in vklopite varovalko, da ponovno zaženete pečico. Če se koda napake pojavi ponovno, se obrnite na pooblaščen servisni center.



Čiščenje

Problem	Preverite naslednje:
Voda izteka iz vbokline pečice.	V vboklini pečice je preveč vode.

12.2 Servisni podatki

Če rešitve težave ne morete najti sami, se obrnite na prodajalca ali pooblaščen servisni center. Potrebni podatki za servisni center se nahajajo na ploščici za tehnične navedbe. Ploščica za tehnične navedbe se nahaja na sprednjem okviru notranjosti pečice. Ploščice za tehnične navedbe ne odstranjujte iz notranjosti pečice.

Priporočamo, da podatke zapišete sem:	
Ime modela (MOD.)
Številka izdelka (PNC)
Serijska številka (S.N.)

13. ENERGIJSKA UČINKOVITOST

13.1 Informacije o izdelku in informacijski list o izdelku*

Ime dobavitelja	AEG	
Identifikacija modela	BPB351160M 944188506 BPS351160M 944188507	
Indeks energijske učinkovitosti	81,2	
Razred energijske učinkovitosti	A+	
Poraba energije pri standardni obremenitvi ter običajnem načinu	1,09 kWh/cikel	
Poraba energije pri standardni obremenitvi in načinu z ventilatorjem	0,69 kWh/cikel	
Število prostorov za peko	1	
Toplotni vir	Elektrika	
Prostornina	71 l	
Vrsta pečice	Vgradna pečica	
Teža	BPB351160M	34.0 kg
	BPS351160M	34.0 kg

* Za Evropsko unijo glede na predpisa EU 65/2014 in 66/2014.
Za Belorusijo glede na STB 2478-2017, dodatek G; STB 2477-2017, prilogi A in B.
Za Ukrajino glede na 568/32020.

Razred energijske učinkovitosti ne velja za Rusijo.

EN 60350-1 - Gospodinjski aparati za kuhanje z elektriko - 1. del: štedilniki, pečice, parne pečice in žari - Postopki za merjenje učinkovitosti delovanja.

13.2 Varčevanje z energijo



Pečica ima funkcije, ki vam pomagajo varčevati z energijo med vsakodnevnim pečenjem.

Poskrbite, da bodo vrata med delovanjem pečice zaprta. Vrat pečice med pečenjem ne odpirajte prepogosto. Poskrbite, da bo tesnilo vrat čisto, in preverite, da je dobro nameščeno. Uporabljajte kovinsko posodo za boljše varčevanje z energijo.

Ko je mogoče, pečice ne segrevajte pred pečenjem.
Presledki med pečenjem več jedi naj bodo čim krajši.

Pečenje z ventilatorjem

Ko je mogoče, uporabljajte funkcije pečenja z ventilatorjem, da prihranite energijo.

Akumulirana toplota

Ventilator in luč še naprej delujeta. Ko izklopite pečico, se na prikazovalniku prikaže akumulirana toplota. To toploto lahko uporabite za ohranjanje toplote hrane.

Pri pečenju, daljšem od 30 minut, tri do 10 minut pred potekom časa pečenja znižajte temperaturo pečice na najnižjo stopnjo. Akumulirana toplota v pečici peče naprej. Z akumulirano toploto pogrejte ostale jedi.

Ohranjanje jedi toplih

Če želite uporabiti akumulirano toploto in ohraniti topel obrok, izberite najnižjo možno nastavitev temperature. Na prikazovalniku se prikaže indikator akumulirane toplote ali temperatura.

Pečenje ob izklopljeni luči

Med pečenjem izklopite luč. Vključite jo samo, ko jo potrebujete.

Vlažno pečenje

Funkcija je zasnovana za varčevanje z energijo med pečenjem.

Ko uporabljate to funkcijo, luč po 30 sekundah samodejno ugasne. Luč lahko ponovno vklopite, a to dejanje bo zmanjšalo pričakovani prihranek energije.



14. STRUKTURA MENIJA

14.1 Meni



— — — – izberite, da vnesete Meni.

Meni struktura



Kuharski pomočnik 	Čiščenje 	Nastavitve 
---	--	--

1. korak	2. korak	3. korak	4. korak	5. korak
	 OK	 O1 - O11	 OK	
Izberite Meni, Nastavitve.	Potrdite nastavitve.	Izberite nastavitve.	Potrdite nastavitve.	Prilagodite vrednost in pritisnite OK.

Nastavitve

O1	Ura	Spremeni	O2	Osvetlitev	1 - 5
O3	Zvok tipk	1 - Pisk 2 - Klik 3 - Zvok izklopljen	O4	Glasnost	1 - 4
O5	Čas delovanja	Vklop/Izklop	O6	Osvetlitev	Vklop/Izklop
O7	Hitro segrevanje pečice	Vklop/Izklop	O8	Opomnik za čiščenje	Vklop/Izklop
O9	Predstavitveni način	Aktivacijska koda: 2468	O10	Različica programske opreme	Preverjanje
O11	Ponastavi vse nastavitve	Da/ne			

15. SKRB ZA OKOLJE

Reciklirajte materiale, ki jih označuje simbol . Embalažo odložite v ustrezne zabojnike za reciklažo. Pomagajte zaščititi okolje in zdravje ljudi ter reciklirati odpadke električnih in elektronskih naprav. Naprav, označenih s simbolom , ne odstranjujte z gospodinjskimi odpadki. Izdelek vrnite na krajevno zbirališče za recikliranje ali se obrnite na občinski urad.

www.aeg.com/shop



867362410-A-032021



AEG

Ovaj dokument je originalno proizveden i objavljen od strane proizvođača, brenda AEG, i preuzet je sa njihove zvanične stranice. S obzirom na ovu činjenicu, Tehnoteka ističe da ne preuzima odgovornost za tačnost, celovitost ili pouzdanost informacija, podataka, mišljenja, saveta ili izjava sadržanih u ovom dokumentu.

Napominjemo da Tehnoteka nema ovlašćenje da izvrši bilo kakve izmene ili dopune na ovom dokumentu, stoga nismo odgovorni za eventualne greške, propuste ili netačnosti koje se mogu naći unutar njega. Tehnoteka ne odgovara za štetu nanесenu korisnicima pri upotrebi netačnih podataka. Ukoliko imate dodatna pitanja o proizvodu, ljubazno vas molimo da kontaktirate direktno proizvođača kako biste dobili sve detaljne informacije.

Za najnovije informacije o ceni, dostupnim akcijama i tehničkim karakteristikama proizvoda koji se pominje u ovom dokumentu, molimo posetite našu stranicu klikom na sledeći link:

<https://tehnoteka.rs/p/aeg-ugradna-rerna-bpb351160m-akcija-cena/>