

Uputstvo za upotrebu (kratko)

GORENJE štapni usisivač SVC216FMLW

gorenje



Tehnoteka je online destinacija za upoređivanje cena i karakteristika bele tehnike, potrošačke elektronike i IT uređaja kod trgovinskih lanaca i internet prodavnica u Srbiji. Naša stranica vam omogućava da istražite najnovije informacije, detaljne karakteristike i konkurentne cene proizvoda.

Posetite nas i uživajte u ekskluzivnom iskustvu pametne kupovine klikom na link:

<https://tehnoteka.rs/p/gorenje-stapni-usisivac-svc216fmlw-akcija-cena/>

gorenje

Life Simplified

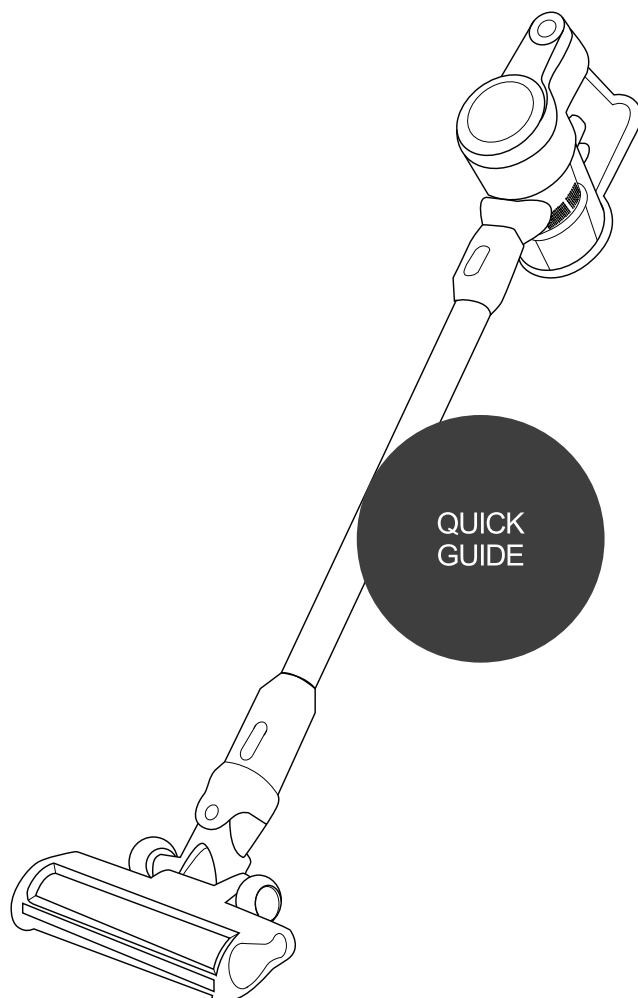

CORDLESS VACUUM CLEANER

FREESTYLE MOVE LITE



78 dB (A)

2/1

Turbo

Icons: Turbo mode, No cord, Battery level, Motor status, Dust container, Motor status, Turbo mode, No cord, Battery level, Motor status, Dust container, Motor status.

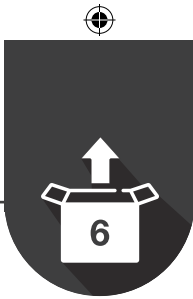

1. Suction hose



2. Motor unit with housing

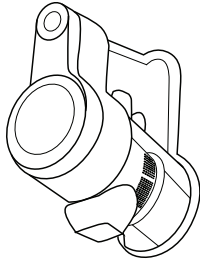

3. Adapter with power cord

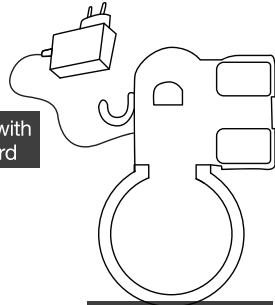

4. Wall-mountable holder

6. Electric brush

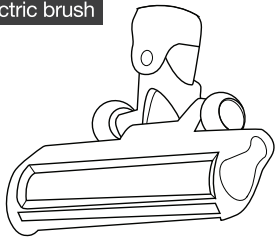

5. Extra attachments

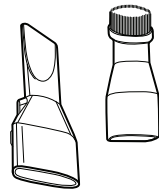

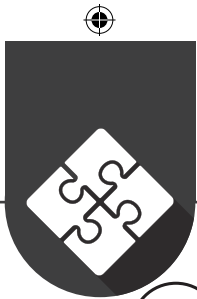

1.

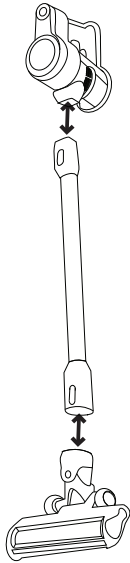

2.

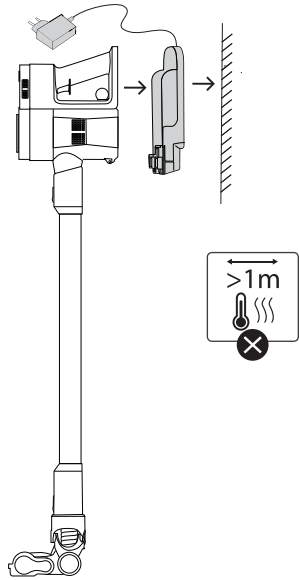

i

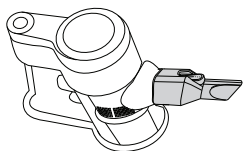
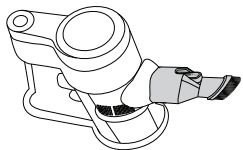
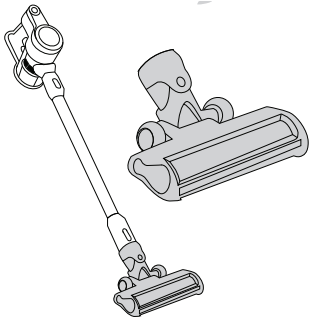

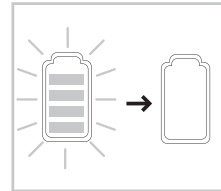
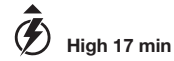
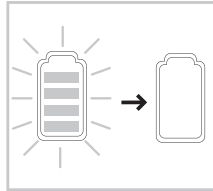
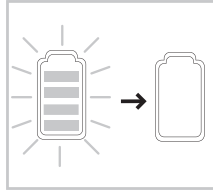
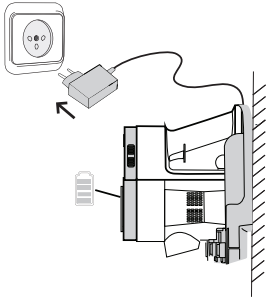

1

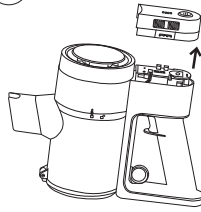

2

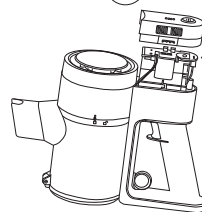

5

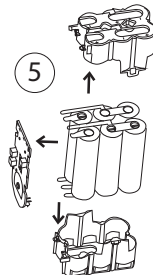

4

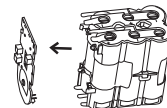

3

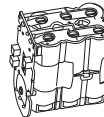

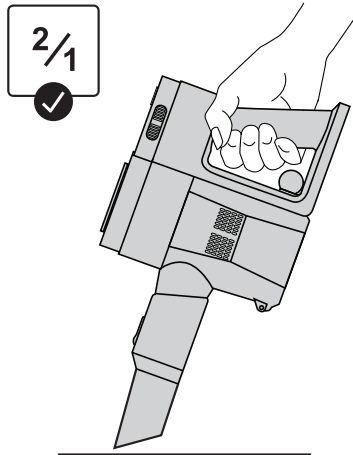
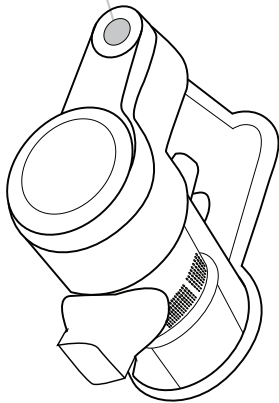
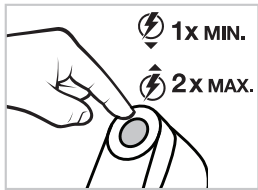
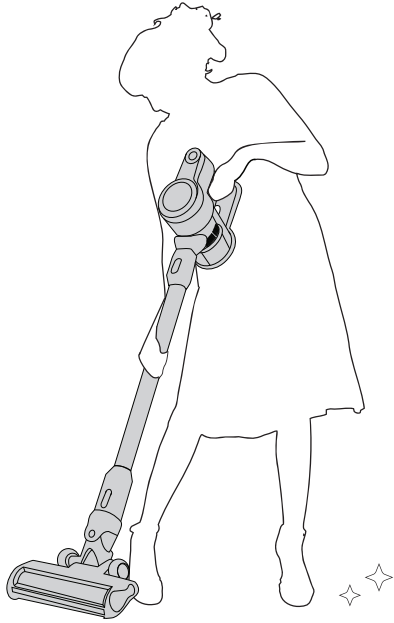
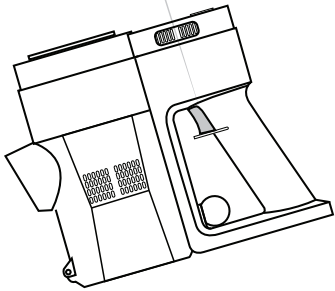
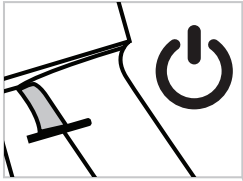



a)

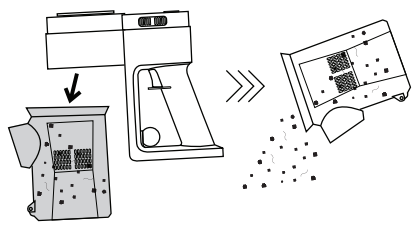

b)

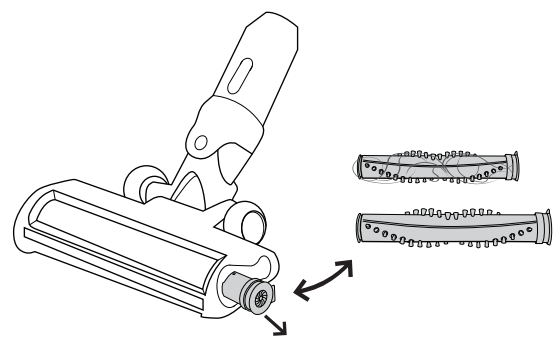
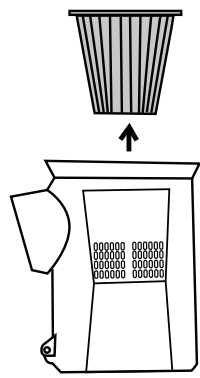
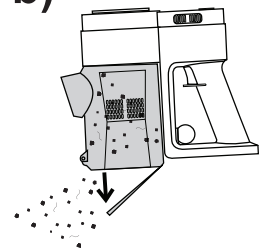

gorenje
Life Simplified

Ovaj dokument je originalno proizveden i objavljen od strane proizvođača, brenda Gorenje, i preuzet je sa njihove zvanične stranice. S obzirom na ovu činjenicu, Tehnoteka ističe da ne preuzima odgovornost za tačnost, celovitost ili pouzdanost informacija, podataka, mišljenja, saveta ili izjava sadržanih u ovom dokumentu.

Napominjemo da Tehnoteka nema ovlašćenje da izvrši bilo kakve izmene ili dopune na ovom dokumentu, stoga nismo odgovorni za eventualne greške, propuste ili netačnosti koje se mogu naći unutar njega. Tehnoteka ne odgovara za štetu nanесenu korisnicima pri upotrebi netačnih podataka. Ukoliko imate dodatna pitanja o proizvodu, ljubazno vas molimo da kontaktirate direktno proizvođača kako biste dobili sve detaljne informacije.

Za najnovije informacije o ceni, dostupnim akcijama i tehničkim karakteristikama proizvoda koji se pominje u ovom dokumentu, molimo posetite našu stranicu klikom na sledeći link:

<https://tehnoteka.rs/p/gorenje-stapni-usisivac-svc216fmlw-akcija-cena/>