

Uputstvo za upotrebu

BEKO ugradni frižider BCNA275E4FN

beko



Tehnoteka je online destinacija za upoređivanje cena i karakteristika bele tehnike, potrošačke elektronike i IT uređaja kod trgovinskih lanaca i internet prodavnica u Srbiji. Naša stranica vam omogućava da istražite najnovije informacije, detaljne karakteristike i konkurentne cene proizvoda.

Posetite nas i uživajte u ekskluzivnom iskustvu pametne kupovine klikom na link:

<https://tehnoteka.rs/p/beko-ugradni-frizider-bcna275e4fn-akcija-cena/>

beko

Refrigerator

Instruction of use

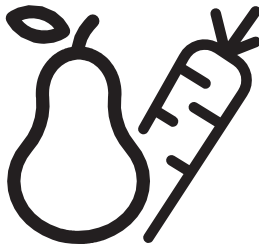

BCNA275E4FN

Please read this user manual first!

Dear Customer,

We hope that your product, which has been produced in modern plants and checked under the most meticulous quality control procedures, will provide you an effective service.



Therefore, read this entire user manual carefully before using the product and keep it as a reference. If you handover the product to someone else, give the user manual as well.

The user manual will help you use the product in a fast and safe way.

- Read the manual before installing and operating the product.
- Make sure you read the safety instructions.
- Keep the manual in an easily accessible place as you may need it later.
- Read the other documents given with the product.
- Remember that this user manual is also applicable for several other models.
- Differences between models will be identified in the manual.

Explanation of symbols

Throughout this user manual the following symbols are used:

-  Important information or useful tips.
-  Warning against dangerous conditions for life and property.
-  Warning against electric voltage.



WARNING!

In order to ensure a normal operation of your refrigerating appliance, which uses a completely environmentally friendly refrigerant the R600a (flammable only under certain conditions) you must observe the following rules:

- Do not hinder the free circulation of the air around the appliance.
- Do not use mechanical devices in order to accelerate the defrosting, others than the ones recommended by the manufacturer.
- Do not destroy the refrigerating circuit.
- Do not use electric appliances inside the food keeping compartment, other than those that might have been recommended by the manufacturer.

INFORMATION



ENERGY



SUPPLIER'S NAME

MODEL IDENTIFIER (*)

A

A

The model information as stored in the product data base can be reached by entering following website and searching for your model identifier (*) found on energy label.

<https://eprel.ec.europa.eu/>

CONTENTS

1 Your refrigerator	3	4 Preparation	10
2 Important Safety Warnings	4	5 Using your refrigerator	11
Intended use	4	Control panel	11
General safety	4	Dual cooling system	12
For products with a water dispenser...	6	Defrost	12
Child safety.....	6	The dairy (cold storage) bin	12
HCA warning.....	6	HarvestFresh	13
Things to be done for energy saving ..	6		
3 Installation	7	6 Maintenance and cleaning	14
Points to be paid attention to when the relocation of the refrigerator	7	Protection of plastic surfaces.....	14
Before you start the refrigerator,.....	7		
Electrical connection.....	7	7 Troubleshooting	15
Disposing of the packaging	8		
Disposing of your old refrigerator	8		
Placing and Installation	8		
Replacing the interior lamp	8		
Reversing the doors	9		

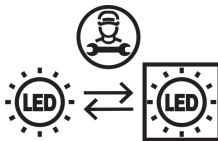

This product is equipped with a lighting source of the "G" energy class. The lighting source in this product shall only be replaced by professional repairers.

Recycling

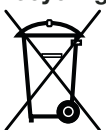

This product is supplied with the selective sorting symbol for waste electrical and electronic equipment (WEEE). This means that this product must be handled pursuant to European Directive 2012/19/EU in order to be recycled or dismantled to minimise its impact on the environment. For further information, please contact your local or regional authorities. Electronic products not included in the selective sorting process are potentially dangerous for the environment and human health due to the presence of hazardous substances.

1 Your refrigerator

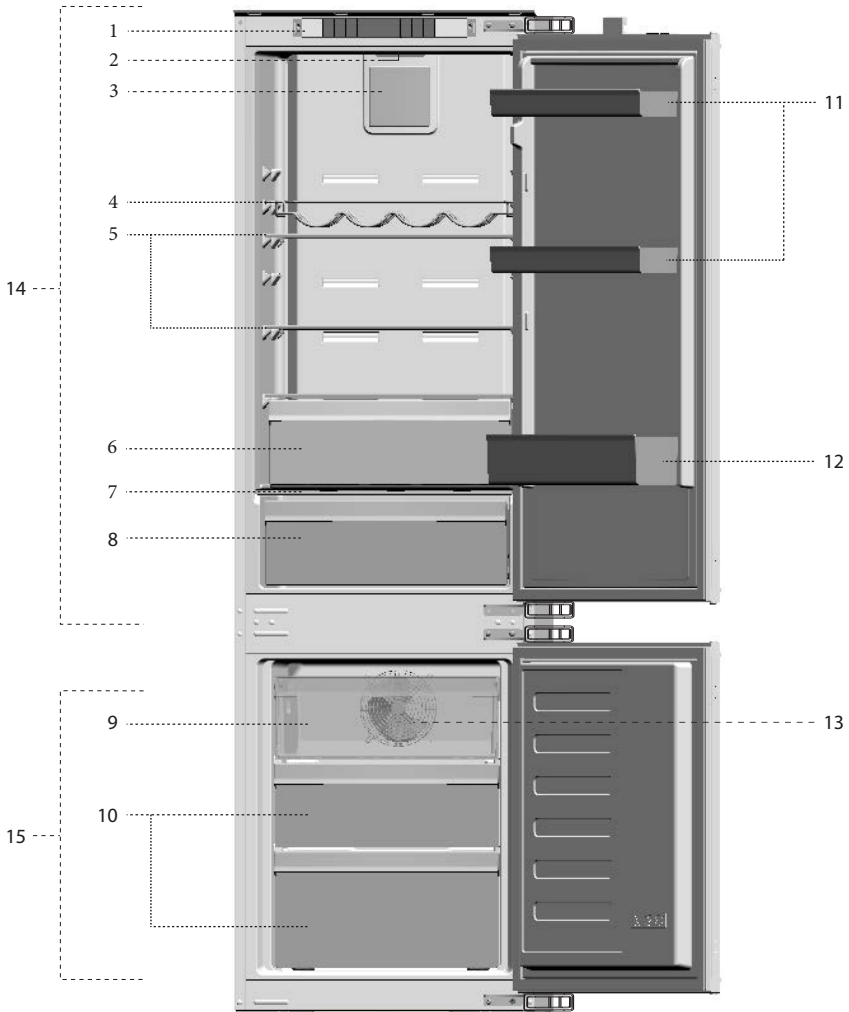

- | | |
|-----------------------|-------------------------------------|
| 1. Control panel | 9. Compartment for quickly freezing |
| 2. Interior light | 10. Freezer compartment drawers |
| 3. Fresh food fan | 11. Adjustable door shelves |
| 4. Wine rack | 12. Bottle shelf |
| 5. Adjustable shelves | 13. Freezer fan |
| 6. Dairy bin | 14. Fridge compartment |
| 7. Crisper cover | 15. Freezer compartment |
| 8. Crisper | |

i Figures that take place in this instruction manual are schematic and may not correspond exactly with your product. If the subject parts are not included in the product you have purchased, then it is valid for other models.

2 Important Safety Warnings

Please review the following information. Failure to observe this information may cause injuries or material damage. Otherwise, all warranty and reliability commitments will become invalid.

Original Spare parts will be provided for 10 years, following the product purchasing date.

Intended use

This product is intended to be used:

- indoors and in closed areas such as homes;
- in closed working environments such as stores and offices;
- in closed accommodation areas such as farm houses, hotels, pensions.
- It should not be used outdoors.

General safety

- When you want to dispose/scrapp the product, we recommend you to consult the authorized service in order to learn the required information and authorized bodies.
- Consult your authorized service for all your questions and problems related to the refrigerator. Do not intervene or let someone intervene to the refrigerator without notifying the authorised services.
- For products with a freezer compartment; Do not eat cone ice cream and ice cubes immediately after you take them out of the freezer compartment! (This may cause frostbite in your mouth.)
- For products with a freezer compartment; Do not put bottled and canned liquid beverages in the freezer compartment. Otherwise, these may burst.

- Do not touch frozen food by hand; they may stick to your hand.
- Unplug your refrigerator before cleaning or defrosting.
- Vapor and vaporized cleaning materials should never be used in cleaning and defrosting processes of your refrigerator. In such cases, the vapor may get in contact with the electrical parts and cause short circuit or electric shock.
- Never use the parts on your refrigerator such as the door as a means of support or step.
- Do not use electrical devices inside the refrigerator.
- Do not damage the parts, where the refrigerant is circulating, with drilling or cutting tools. The refrigerant that might blow out when the gas channels of the evaporator, pipe extensions or surface coatings are punctured causes skin irritations and eye injuries.
- Do not cover or block the ventilation holes on your refrigerator with any material.
- Electrical devices must be repaired by only authorised persons. Repairs performed by incompetent persons create a risk for the user.
- In case of any failure or during a maintenance or repair work, disconnect your refrigerator's mains supply by either turning off the relevant fuse or unplugging your appliance.
- Do not pull by the cable when pulling off the plug.
- Place the beverage with higher proofs tightly closed and vertically.

- Never store spray cans containing flammable and explosive substances in the refrigerator.
- Do not use mechanical devices or other means to accelerate the defrosting process, other than those recommended by the manufacturer.
- This appliance is not intended for use by persons (including children) with reduced physical, sensory or mental capabilities, or lack of experience and knowledge, unless they have been given supervision or instruction concerning use of the appliance by a person responsible for their safety. Children should be supervised to ensure that they do not play with the appliance.
- Do not operate a damaged refrigerator. Consult with the service agent if you have any concerns.
- Electrical safety of your refrigerator shall be guaranteed only if the earth system in your house complies with standards.
- Exposing the product to rain, snow, sun and wind is dangerous with respect to electrical safety.
- Contact authorized service when there is a power cable damage to avoid danger.
- Never plug the refrigerator into the wall outlet during installation. Otherwise, risk of death or serious injury may arise.
- This refrigerator is intended for only storing food items. It must not be used for any other purpose.
- Label of technical specifications is located on the left wall inside the refrigerator.
- Never connect your refrigerator to electricity-saving systems; they may damage the refrigerator.
- If there is a blue light on the refrigerator, do not look at the blue light with optical tools.
- For manually controlled refrigerators, wait for at least 5 minutes to start the refrigerator after power failure.

- This operation manual should be handed in to the new owner of the product when it is given to others.
- Avoid causing damage on power cable when transporting the refrigerator. Bending cable may cause fire. Never place heavy objects on power cable.

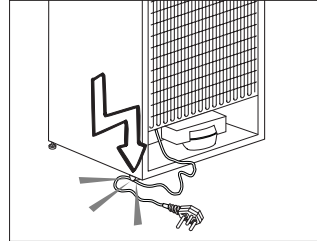

- Do not touch the plug with wet hands when plugging the product.
- Do not plug the refrigerator if the wall outlet is loose.
- Water should not be sprayed on inner or outer parts of the product for safety purposes.
- Do not spray substances containing inflammable gases such as propane gas near the refrigerator to avoid fire and explosion risk.
- Never place containers filled with water on top of the refrigerator; in the event of spillages, this may cause electric shock or fire.
- Do not overload the refrigerator with food. If overloaded, the food items may fall down and hurt you and damage refrigerator when you open the door.
- Never place objects on top of the refrigerator; otherwise, these objects may fall down when you open or close the refrigerator's door.
- As they require a precise temperature, vaccines, heat-sensitive medicine and scientific materials and etc. should not be kept in the refrigerator.

- If not to be used for a long time, refrigerator should be unplugged. A possible problem in power cable may cause fire.
- The plug's tip should be cleaned regularly with a dry cloth; otherwise, it may cause fire.
- Refrigerator may move if adjustable legs are not properly secured on the floor. Properly securing adjustable legs on the floor can prevent the refrigerator to move.
- When carrying the refrigerator, do not hold it from door handle. Otherwise, it may be snapped.
- When you have to place your product next to another refrigerator or freezer, the distance between devices should be at least 8 cm. Otherwise, adjacent side walls may be humidified.

For products with a water dispenser

Pressure of water mains should be minimum 1 bar. Pressure of water mains should be maximum 8 bars.

- Use only potable water.

Child safety

- If the door has a lock, the key should be kept away from reach of children.
- Children must be supervised to prevent them from tampering with the product.

HCA warning

If your product's cooling system contains R600a:

This gas is flammable. Therefore, pay attention to not damaging the cooling system and piping during usage and transportation. In the event of damage, keep your product away from potential fire sources that can cause the product catch a fire and ventilate the room in which the unit is placed.

Ignore this warning if your product's cooling system contains R134a.

Type of gas used in the product is stated in the type label which is on the left wall inside the refrigerator.

Never throw the product in fire for disposal.

Things to be done for energy saving

- Do not leave the doors of your refrigerator open for a long time.
- Do not put hot food or drinks in your refrigerator.
- Do not overload your refrigerator so that the air circulation inside of it is not prevented.
- Do not install your refrigerator under direct sunlight or near heat emitting appliances such as ovens, dishwashers or radiators. Keep your refrigerator at least 30 cm away from heat emitting sources and at least 5 cm from electrical ovens.
- Pay attention to keep your food in closed containers.
- For products with a freezer compartment; You can store maximum amount of food items in the freezer when you remove the shelf or drawer of the freezer. Energy consumption value stated for your refrigerator has been determined by removing freezer shelf or drawer and under maximum load. There is no harm to use a shelf or drawer according to the shapes and size of food to be frozen.
- Thawing frozen food in fridge compartment will both provide energy saving and preserve the food quality.

3 Installation

⚠ In case the information which are given in the user manual are not taken into account, manufacturer will not assume any liability for this.

Points to be paid attention to when the relocation of the refrigerator

1. Your refrigerator should be unplugged. Before transportation of your refrigerator, it should be emptied and cleaned.
2. Before it is re-packaged, shelves, accessories, crisper, etc. inside your refrigerator should be fixed with adhesive tape and secured against impacts. Package should be bound with a thick tape or sound ropes and the transportation rules on the package should be strictly observed.
3. Original packaging and foam materials should be kept for future transportations or moving.

Before you start the refrigerator

Check the following before you start to use your refrigerator:

1. Is the interior of the refrigerator dry and can the air circulate freely in the rear of it?
2. Clean the interior of the refrigerator as recommended in the "Maintenance and cleaning" section.
3. Connect the plug of the refrigerator to the wall socket. When the fridge door is opened, fridge internal lamp will turn on.

4. When the compressor starts to operate, a sound will be heard. The liquid and gases sealed within the refrigeration system may also give rise to noise, even if the compressor is not running and this is quite normal.
5. Front edges of the refrigerator may feel warm. This is normal. These areas are designed to be warm to avoid condensation.

Electrical connection

Connect your product to a grounded socket which is being protected by a fuse with the appropriate capacity.

Important:

The connection must be in compliance with national regulations.

- The power plug must be easily accessible after installation.
- Electrical safety of your refrigerator shall be guaranteed only if the earth system in your house complies with standards.
- The voltage stated on the label located at left inner side of your product should be equal to your network voltage.
- **Extension cables and multi plugs must not be used for connection.**

⚠ A damaged power cable must be replaced by a qualified electrician.

⚠ Product must not be operated before it is repaired! There is the risk of electric shock!

Disposing of the packaging

The packing materials may be dangerous for children. Keep the packing materials out of the reach of children or dispose of them by classifying them in accordance with the waste instructions stated by your local authorities. Do not throw away with regular house waste, throw away on packaging pick up spots designated by the local authorities. The packing of your refrigerator is produced from recyclable materials.

Disposing of your old refrigerator

Dispose of your old refrigerator without giving any harm to the environment.

- You may consult your authorized dealer or waste collection center of your municipality about the disposal of your refrigerator.

Before disposing of your refrigerator, cut out the electric plug and, if there are any locks on the door, make them inoperable in order to protect children against any danger.

Placing and Installation

⚠ If the entrance door of the room where the refrigerator will be installed is not wide enough for the refrigerator to pass through, then call the authorized service to have them remove the doors of your refrigerator and pass it sideways through the door.

1. Install your refrigerator to a place that allows ease of use.
2. Keep your refrigerator away from heat sources, humid places and direct sunlight.
3. There must be appropriate air ventilation around your refrigerator in order to achieve an efficient operation. If the refrigerator is to be placed in a recess in the wall, there must be at least 5 cm distance with the ceiling and at least 5 cm with the wall. Do not place your product on the materials such as rug or carpet.
4. Place your refrigerator on an even floor surface to prevent jolts.
5. Do not keep your refrigerator in ambient temperatures under 10°C.

Replacing the interior lamp

To change the Bulb/LED used for illumination of your refrigerator, call your Authorised Service.

The lamp(s) used in this appliance is not suitable for household room illumination. The intended purpose of this lamp is to assist the user to place foodstuffs in the refrigerator/freezer in a safe and comfortable way. The lamps used in this appliance have to withstand extreme physical conditions such as temperatures below -20°C.

Reversing the doors

Proceed in numerical order.

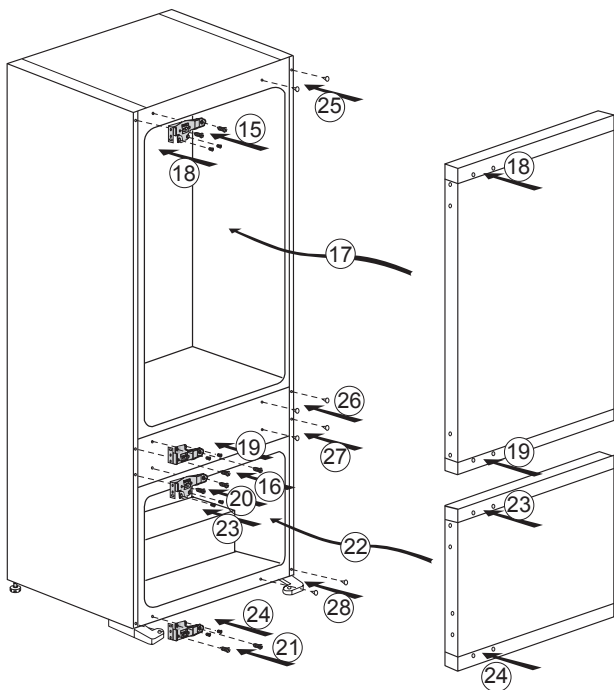
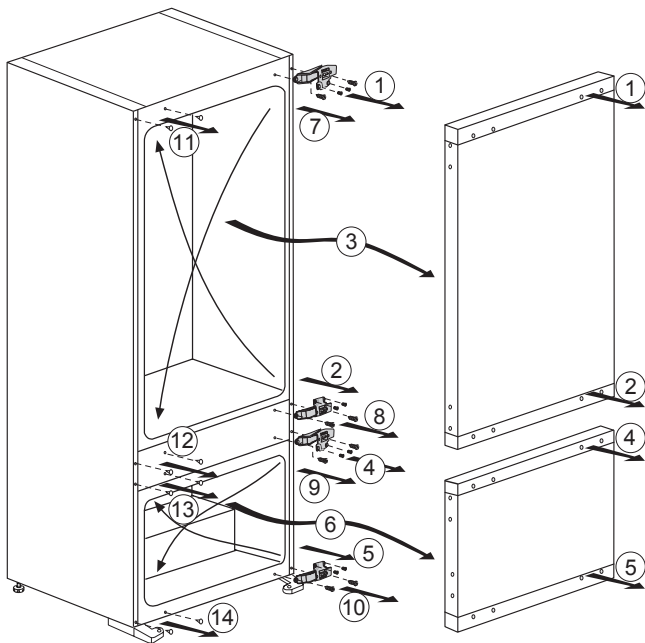

4 Preparation

- Your refrigerator should be installed at least 30 cm away from heat sources such as hobs, ovens, central heater and stoves and at least 5 cm away from electrical ovens and should not be located under direct sunlight.
- The ambient temperature of the room where you install your refrigerator should at least be 10°C. Operating your refrigerator under cooler conditions is not recommended with regard to its efficiency.
- Please make sure that the interior of your refrigerator is cleaned thoroughly.
- If two refrigerators are to be installed side by side, there should be at least 2 cm distance between them.
- When you operate your refrigerator for the first time, please observe the following instructions during the initial six hours.
- The door should not be opened frequently.
- It must be operated empty without any food in it.
- Do not unplug your refrigerator. If a power failure occurs out of your control, please see the warnings in the “Troubleshooting” section.
- Original packaging and foam materials should be kept for future transportations or moving.

5 Using your refrigerator

Control Panel

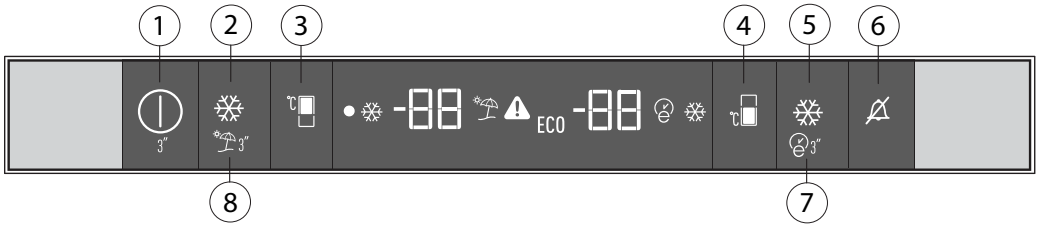

1. On / Off Indicator

Press the On / Off button for 3 seconds to turn off or turn on the fridge. When the fridge is off, the symbol (⏻) is lit. All the other symbols are turned off.

2. Quick fridge function button

The button (❄️) has two functions. To activate or deactivate the Quick Cool function, press it briefly. Quick Cool indicator will turn off and the product return to its normal settings.

Use the Quick Cooling function when you want to quickly cool the food placed in the fridge compartment. If you want to cool large amounts of fresh food, activate this function before putting the food into the product.

If you do not cancel it, Quick Cooling will cancel itself automatically after 1 hour at the most, or when the fridge compartment reaches the required temperature. This function is not recalled when power restores after a power failure.

3. Fridge compartment temperature setting button

Press this button (🌡️) to set the temperature of the fridge compartment to 8, 7, 6, 5, 4, 3, 2, 8... respectively. Press this button to set the fridge compartment temperature to the desired value.

4. Freezer compartment temperature setting button

Press this button (🌡️) to set the temperature of the freezer compartment to -18, -19, -20, -21, -22, -23, -24, -18... respectively. Press this button to set the freezer compartment temperature to the desired value.

5. Quick freeze function button

Press this button (❄️) to activate or deactivate the Quick freeze function. When you activate the function, the freezer compartment will be cooled to a temperature lower than the set value.

Use the Quick Freeze function when you want to quickly freeze the food placed in freezer compartment. If you want to freeze large amounts of fresh food, activate this function before putting the food into the product.

If you do not cancel it, Quick Freeze will cancel itself automatically after 25 hours at the most or when the freezer compartment reaches the required temperature. This function is not recalled when power restores after a power failure.

6. Alarm off warning

In case of power failure / high temperature alarm, after checking the food located in the freezer compartment press the alarm off button (🔔) to clear the warning.

7. Eco fuzzy

Press and hold the eco fuzzy button (🌿) for 3 seconds to activate the Eco fuzzy function. The refrigerator will start to operate in the most economic mode at least 6 hours later and the economic usage indicator will be on (🌿). Press and hold the eco fuzzy function button for 3 seconds to disable the eco fuzzy function. This indicator will be on after 6 hours when eco fuzzy is activated, provided the doors are not opened.

ECO indicator will be active if the freezer compartment temperature is set to -18°C.

8. Vacation Function

In order to activate Vacation function, press this button (🏖️) for 3 seconds, and the vacation mode indicator (🏖️) will be activated. When the vacation function is activated, “-” is displayed on the fridge compartment temperature indicator and no active cooling is performed in the fridge compartment. It is not suitable to keep the food in the fridge compartment in this function. Other compartments will continue to be cooled according to their set temperatures. To cancel this function press **Vacation** function button again.

Dual cooling system

Your refrigerator is equipped with two separate cooling systems to cool the fresh food compartment and freezer compartment. Thus, air in the fresh food compartment and freezer compartment do not get mixed. Thanks to these two separate cooling systems, cooling speed is much higher than other refrigerators. Odors in the compartments do not get mixed. Also additional power saving is provided since the defrosting is performed individually.

Defrost

A) Fridge compartment

Fridge compartment performs full-automatic defrosting.

The defrost water runs to the drain tube via a collection container at the back of the appliance. Check that the tube is permanently placed with its end in the collecting tray on the compressor to prevent the water spilling on the electric installation or on the floor.

B) Freezer compartment

The **NO FROST** type defrost is completely automatic. No intervention from your side is required. The water is collected on the compressor tray. Due to the heat of the compressor the water is evaporated.

Warnings!

The fans inside the freezer and fresh food compartments circulates cold air. Never insert any object through the guard. Do not allow children to play with the fresh food and freezer fan.

Never store products that contain inflammable propellant gas (e.g. dispensers, spray cans etc.) or explosive substances.

Don't cover the shelves with any protective materials, which may obstruct air circulation.

Do not allow children to play with the appliance or tamper with the controls. Do not obstruct the fan guards to ensure that you obtain the best possible performance from your appliance.

Please ensure the fans are not blocked (stopped) or impaired by food or packaging. Blocking (stopping) or impairing the fan can result in an increase of the internal freezer temperature (Thawing).

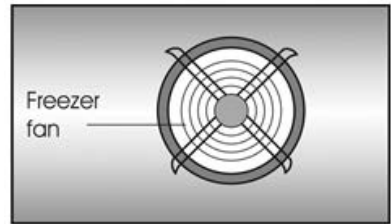
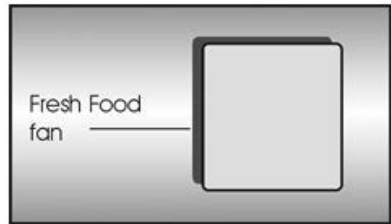

The dairy (cold storage) bin

The dairy (cold storage) bin provides lower temperature within the refrigerator compartment. Use this bin to store delicatessen (salami, sausages, dairy products and etc.) that requires lower storage temperature or meat, chicken or fish products for immediate consumption. Do not store fruits and vegetables inside this bin.

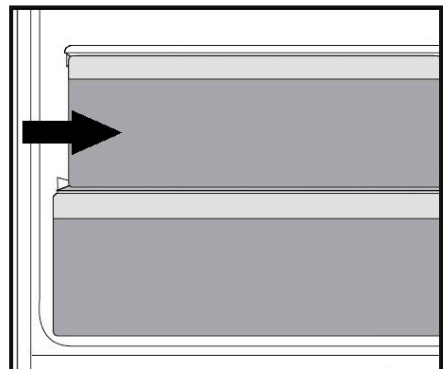

HarvestFresh

Fruits and vegetables stored in crispers illuminated with the HarvestFresh technology preserve their vitamin content (vitamin A and C) for a longer time thanks to the blue, green, red lights and dark cycles, which simulate a day cycle.

If you open the door of the refrigerator during the dark period of the HarvestFresh technology, the refrigerator will automatically detect this and enable the blue, green or red light to illuminate the crisper for your convenience. After you have closed the door of the refrigerator, the dark period will continue, representing the night time in a day cycle.

6 Maintenance and cleaning

- ⚠ Never use gasoline, benzene or similar substances for cleaning purposes.
- ⚠ We recommend that you unplug the appliance before cleaning.
- ⚠ Never use any sharp abrasive instrument, soap, household cleaner, detergent and wax polish for cleaning.
- ℹ Use lukewarm water to clean the cabinet of your refrigerator and wipe it dry.
- ℹ Use a damp cloth wrung out in a solution of one teaspoon of bicarbonate of soda to one pint of water to clean the interior and wipe it dry.
- ⚠ Make sure that no water enters the lamp housing and other electrical items.
- ⚠ If your refrigerator is not going to be used for a long period of time, unplug the power cable, remove all food, clean it and leave the door ajar.
- ℹ Check door seals regularly to ensure they are clean and free from food particles.
- ⚠ To remove door racks, remove all the contents and then simply push the door rack upwards from the base.
- ⚠ Never use cleaning agents or water that contain chlorine to clean the outer surfaces and chromium coated parts of the product. Chlorine causes corrosion on such metal surfaces.

Protection of plastic surfaces

- ℹ Do not put the liquid oils or oil-cooked meals in your refrigerator in unsealed containers as they damage the plastic surfaces of your refrigerator. In case of spilling or smearing oil on the plastic surfaces, clean and rinse the relevant part of the surface at once with warm water.

7 Troubleshooting

Please review this list before calling the service. It will save your time and money. This list includes frequent complaints that are not arising from defective workmanship or material usage. Some of the features described here may not exist in your product.

The refrigerator does not operate.

- The plug is not inserted into the socket correctly. >>>Insert the plug into the socket securely.
- The fuse of the socket which your refrigerator is connected to or the main fuse have blown out. >>>Check the fuse.

Condensation on the side wall of the fridge compartment (MULTIZONE, COOL CONTROL and FLEXI ZONE).

- Ambient is very cold. >>>Do not install the refrigerator in places where the temperature falls below 10°C.
- Door has been opened frequently. >>>Do not open and close the door of refrigerator frequently.
- Ambient is very humid. >>>Do not install your refrigerator into highly humid places.
- Food containing liquid is stored in open containers. >>>Do not store food with liquid content in open containers.
- Door of the refrigerator is left ajar. >>>Close the door of the refrigerator.
- Thermostat is set to a very cold level. >>>Set the thermostat to a suitable level.

Compressor is not running.

- Protective thermic of the compressor will blow out during sudden power failures or plug-out plug-ins as the refrigerant pressure in the cooling system of the refrigerator has not been balanced yet. The refrigerator will start running approximately after 6 minutes. Please call the service if the refrigerator does not startup at the end of this period.
- The fridge is in defrost cycle. >>>This is normal for a full-automatically defrosting refrigerator. Defrosting cycle occurs periodically.
- The refrigerator is not plugged into the socket. >>>Make sure that the plug is fit into the socket.
- Temperature settings are not made correctly. >>>Select the suitable temperature value.
- There is a power outage. >>>Refrigerator returns to normal operation when the power restores.

The operation noise increases when the refrigerator is running.
<ul style="list-style-type: none"> The operating performance of the refrigerator may change due to the changes in the ambient temperature. It is normal and not a fault.
The refrigerator is running frequently or for a long time.
<ul style="list-style-type: none"> New product may be wider than the previous one. Larger refrigerators operate for a longer period of time. The room temperature may be high. >>>It is normal that the product operates for longer periods in hot ambient. The refrigerator might be plugged in recently or might be loaded with food. >>>When the refrigerator is plugged in or loaded with food recently, it will take longer for it to attain the set temperature. This is normal. Large amounts of hot food might be put in the refrigerator recently. >>>Do not put hot food into the refrigerator. Doors might be opened frequently or left ajar for a long time. >>>The warm air that has entered into the refrigerator causes the refrigerator to run for longer periods. Do not open the doors frequently. Freezer or fridge compartment door might be left ajar. >>>Check if the doors are closed completely. The refrigerator is adjusted to a very low temperature. >>>Adjust the refrigerator temperature to a warmer degree and wait until the temperature is achieved. Door seal of the fridge or freezer may be soiled, worn out, broken or not properly seated. >>>Clean or replace the seal. Damaged/broken seal causes the refrigerator to run for a longer period of time in order to maintain the current temperature.
Freezer temperature is very low while the fridge temperature is sufficient.
<ul style="list-style-type: none"> The freezer temperature is adjusted to a very low value. >>>Adjust the freezer temperature to a warmer degree and check.
Fridge temperature is very low while the freezer temperature is sufficient.
<ul style="list-style-type: none"> The fridge temperature is adjusted to a very low value. >>>Adjust the fridge temperature to a warmer degree and check.
Food kept in the fridge compartment drawers is frozen.
<ul style="list-style-type: none"> The fridge temperature is adjusted to a very high value. >>>Adjust the fridge temperature to a lower value and check.

Temperature in the fridge or freezer is very high.
<ul style="list-style-type: none"> The fridge temperature is adjusted to a very high value. >>>Fridge compartment temperature setting has an effect on the temperature of the freezer. Change the temperatures of the fridge or freezer and wait until the relevant compartments attain a sufficient temperature. Doors are opened frequently or left ajar for a long time. >>>Do not open the doors frequently. Door is ajar. >>>Close the door completely. The refrigerator is plugged in or loaded with food recently. >>>This is normal. When the refrigerator is plugged in or loaded with food recently, it will take longer for it to attain the set temperature. Large amounts of hot food might be put in the refrigerator recently. >>>Do not put hot food into the refrigerator.
Vibrations or noise.
<ul style="list-style-type: none"> The floor is not level or stable. >>> If the refrigerator rocks when moved slowly, balance it by adjusting its feet. Also make sure that the floor is strong enough to carry the refrigerator, and level. The items put onto the refrigerator may cause noise. >>>Remove the items on top of the refrigerator.
There are noises coming from the refrigerator like liquid flowing, spraying, etc.
<ul style="list-style-type: none"> Liquid and gas flows occur in accordance with the operating principles of your refrigerator. It is normal and not a fault.
Whistle comes from the refrigerator.
<ul style="list-style-type: none"> Fans are used in order to cool the refrigerator. It is normal and not a fault.
Condensation on the inner walls of refrigerator.
<ul style="list-style-type: none"> Hot and humid weather increases icing and condensation. It is normal and not a fault. Doors are opened frequently or left ajar for a long time. >>>Do not open the doors frequently. Close them if they are open. Door is ajar. >>>Close the door completely.
Humidity occurs on the outside of the refrigerator or between the doors.
<ul style="list-style-type: none"> There might be humidity in the air; this is quite normal in humid weather. When the humidity is less, condensation will disappear.
Bad odour inside the refrigerator.
<ul style="list-style-type: none"> No regular cleaning is performed. >>>Clean the inside of the refrigerator regularly with a sponge, lukewarm water or carbonate dissolved in water. Some containers or package materials may cause the smell. >>>Use a different container or different brand packaging material. Food is put into the refrigerator in uncovered containers. >>>Keep the food in closed containers. Microorganisms spreading out from uncovered containers can cause unpleasant odours. Remove the foods that have expired best before dates and spoiled from the refrigerator.
The door is not closing.
<ul style="list-style-type: none"> Food packages are preventing the door from closing. >>>Replace the packages that are obstructing the door. The refrigerator is not completely even on the floor. >>>Adjust the feet to balance the refrigerator. The floor is not level or strong. >>>Make sure that the floor is level and capable to carry the refrigerator.
Crispers are stuck.
<ul style="list-style-type: none"> The food is touching the ceiling of the drawer. >>>Rearrange food in the drawer.

Ovaj dokument je originalno proizveden i objavljen od strane proizvođača, brenda Beko, i preuzet je sa njihove zvanične stranice. S obzirom na ovu činjenicu, Tehnoteka ističe da ne preuzima odgovornost za tačnost, celovitost ili pouzdanost informacija, podataka, mišljenja, saveta ili izjava sadržanih u ovom dokumentu.

Napominjemo da Tehnoteka nema ovlašćenje da izvrši bilo kakve izmene ili dopune na ovom dokumentu, stoga nismo odgovorni za eventualne greške, propuste ili netačnosti koje se mogu naći unutar njega. Tehnoteka ne odgovara za štetu nanесenu korisnicima pri upotrebi netačnih podataka. Ukoliko imate dodatna pitanja o proizvodu, ljubazno vas molimo da kontaktirate direktno proizvođača kako biste dobili sve detaljne informacije.

Za najnovije informacije o ceni, dostupnim akcijama i tehničkim karakteristikama proizvoda koji se pominje u ovom dokumentu, molimo posetite našu stranicu klikom na sledeći link:

<https://tehnoteka.rs/p/beko-ugradni-frizider-bcna275e4fn-akcija-cena/>