

Uputstvo za instalaciju

HISENSE klima V Pie TV35VD1G

Hisense



Tehnoteka je online destinacija za upoređivanje cena i karakteristika bele tehnike, potrošačke elektronike i IT uređaja kod trgovinskih lanaca i internet prodavnica u Srbiji. Naša stranica vam omogućava da istražite najnovije informacije, detaljne karakteristike i konkurentne cene proizvoda.

Posetite nas i uživajte u ekskluzivnom iskustvu pametne kupovine klikom na link:

<https://tehnoteka.rs/p/hisense-klima-v-pie-tv35vd1g-akcija-cena/>

The Hisense logo is rendered in a bold, black, sans-serif font. It is positioned in the upper left quadrant of the page, partially enclosed by a large, white, circular graphic element that consists of several overlapping, semi-transparent rings.

USE AND INSTALLATION INSTRUCTIONS

Thank you very much for purchasing this Air Conditioner. Please read this use and installation instructions carefully before installing and using this appliance and keep this manual for future reference.

Contents

Safety instructions	1
Preparation before use	3
Safety Precautions	4
Installation instructions	
Installation diagram	5
Select the installation locations	6
Indoor unit installation	7
Outdoor unit installation	12
Air purging	12
Maintenance	14
Protection	15
Troubleshooting	16
Identification of parts	17
Indoor unit	17
Outdoor unit	17
Display introduction	18

Remote controller operating instructions. See "remote controller instructions".

Safety instructions

- 1. To guarantee the unit work normally, please read the manual carefully before installation, and try to install strictly according to this manual.
- 2. Do not let air enter the refrigeration system or discharge refrigerant when moving the air conditioner.
- 3. Properly ground the air conditioner into the earth.
- 4. Check the connecting cables and pipes carefully, make sure they are correct and firm before connecting the power of the air conditioner.
- 5. There must be an air-break switch.
- 6. After installing, the consumer must operate the air conditioner correctly according to this manual, keep a suitable storage for maintenance and moving of the air conditioner in the future.
- 7. Fuse of indoor unit: T3.15A 250VAC or T5A 250VAC. Please refer to the screen printing on the circuit board for the actual parameters, which must be consistent with the parameters on the screen printing.
- 8. The installation instructions for appliances that are intended to be permanently connected to fixed wiring, and have a leakage current that may exceed 10 mA, shall state that the installation of a residual current device (RCD) having a rated residual operating current not exceeding 30 mA is advisable.
- 9. Warning: Risk of electric shock can cause injury or death: Disconnect all remote electric power supplies before servicing .
- 10. The maximum length of the connecting pipe between the indoor unit and outdoor unit should be less than 5 meters. It will affect the efficiency of the air conditioner if the distance longer than that length.
- 11. This appliance is not intended for use by persons (including children) with reduced physical, sensory or mental capabilities, or lack of experience and knowledge, unless they have been given supervision or instruction concerning use of the appliance by a person responsible for their safety. Children should be supervised to ensure that they do not play with the appliance.
- 12. This appliance can be used by children aged from 8 years and above and persons with reduced physical, sensory or mental capabilities or lack of experience and knowledge if they have been given supervision or instruction concerning use of the appliance in a safe way and understand the hazards involved. Children shall not play with the appliance. Cleaning and user maintenance shall not be made by children without supervision.
- 13. The batteries in remote controller must be recycled or disposed of properly. Disposal of Scrap Batteries --- Please discard the batteries as sorted municipal waste at the accessible collection point.
- 14. If the appliance is fixed wiring, the appliance must be fitted with means for disconnection from the supply mains having a contact separation in all poles that provide full disconnection under over voltage category III conditions, and these means must be incorporated in the fixed wiring in accordance with the wiring rules. If the supply cord is damaged, it must be replaced by the manufacturer, its service agent or similarly qualified persons in order to avoid a hazard.

Safety instructions

- 15. If the supply cord is damaged, it must be replaced by the manufacturer, its service agent or similarly qualified persons in order to avoid a hazard.
- 16. The appliance shall be installed in accordance with national wiring regulations.
- 17. The air conditioner must be installed by professional or qualified persons.
- 18. The appliance shall not be installed in the laundry.
- 19. Regarding to installation, please refer to section “Installation instructions”.
- 20. Regarding to maintenance, please refer to section “Maintenance”.

Preparation before use

Note

- When charging refrigerant into the system, make sure to charge in liquid state, if the refrigerant of the appliance is R22 or R410A. Otherwise, chemical composition of refrigerant (R22 or R410A) inside the system may change and thus affect performance of the air conditioner.
- According to the character of refrigerant (R410A, the value of GWP is 2088), the pressure of the tube is very high, so be sure to be careful when you install and repair the appliance.
- If the supply cord is damaged, it must be replaced by the manufacturer, its service agent or similarly qualified persons in order to avoid a hazard.
- The air conditioner must be installed by a professional engineer.
- The temperature of refrigerant circuit will be high, please keep the interconnection cable away from the copper tube.

Preset

Before using the air conditioner, be sure to check and preset as the following.

- **Remote Controller presetting**
Each time after the remote control is replaced with new batteries or is energized, remote control auto presetting heat pump. If the air conditioner you purchased is a Cooling Only one, heat pump remote controller can also be used.
- **Back-light function (optional)**
Hold down any button of the remote controller for about 2 seconds, the back-light will be turned on. It will be turned off automatically after about 10 seconds.
- **Auto Restart Presetting**
The air conditioner has Auto-Restart function.
You can set or cancel this function when the air conditioner is running.
 - Hold down the emergency button (ON/OFF) for a few seconds, this function will be set if you hear beep twice. If you just hear beep once, this function will be canceled.

Safeguarding the environment

This appliance is made of recyclable or re-usable material. Scrapping must be carried out in compliance with local waste disposal regulations. Before scrapping it, make sure to cut off the mains cord so that the appliance cannot be re-used.

For more detailed information on handling and recycling this product, contact your local authorities who deal with the separate collection of rubbish or the shop where you bought the appliance.

SCRAPPING OF APPLIANCE

This appliance is marked according to the European Directive 2012/19/EC, Waste Electrical and Electronic Equipment (WEEE).

This marking indicates that this product should not be disposed with other household wastes throughout the EU. To prevent possible harm to the environment or human health from uncontrolled waste disposal, recycle it responsibly to promote the sustainable reuse of material resources. To return your used device, please use the return and collection systems or contact the retailer where the product was purchased. They can take this product for environmental safe recycling.



Safety precautions

Symbols in this Use and Care Manual are interpreted as shown below.



Be sure not to do.



Grounding is essential.



Pay attention to such a situation.



Warning: Incorrect handling could cause a serious hazard, such as death, serious injury, etc.

Use correct power supply in accordance with the rating plate requirement. Otherwise, serious faults or hazard may occur or a fire may break out.



Keep the power supply circuit breaker or plug from dirt. Connect the power supply cord to it firmly and correctly, lest an electric shock or a fire break out due to insufficient contact.



Do not use the power supply circuit breaker or pull off the plug to turn it off during operation. This may cause a fire due to spark, etc.



It is the user's responsibility to make the appliance be grounded according to local codes or ordinances by a licenced technician.

It is harmful to your health if the cool air reaches you for a long time. It is advisable to let the air flow be deflected to all the room.

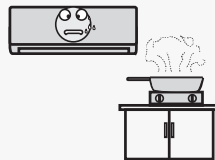

Prevent the air flow from reaching the gas burners and stove.

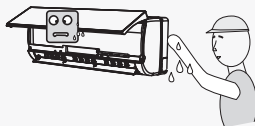

Do not touch the operation buttons when your hands are wet.



Turn off the appliance by remote control firstly before cutting off power supply if malfunction occurs.

Never insert a stick or similar obstacle to the unit. Since the fan rotates at high speed, this may cause an injury.

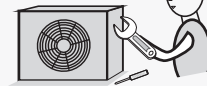

Do not repair the appliance by yourself. If this is done incorrectly, it may cause an electric shock, etc.

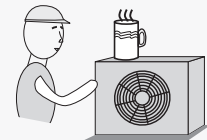

Do not put any objects on the outdoor unit.



Do not knit, pull or press the power supply cord, lest the power supply cord be broken. An electric shock or fire is probably caused by a broken power supply cord.

Installation instructions

Installation diagram

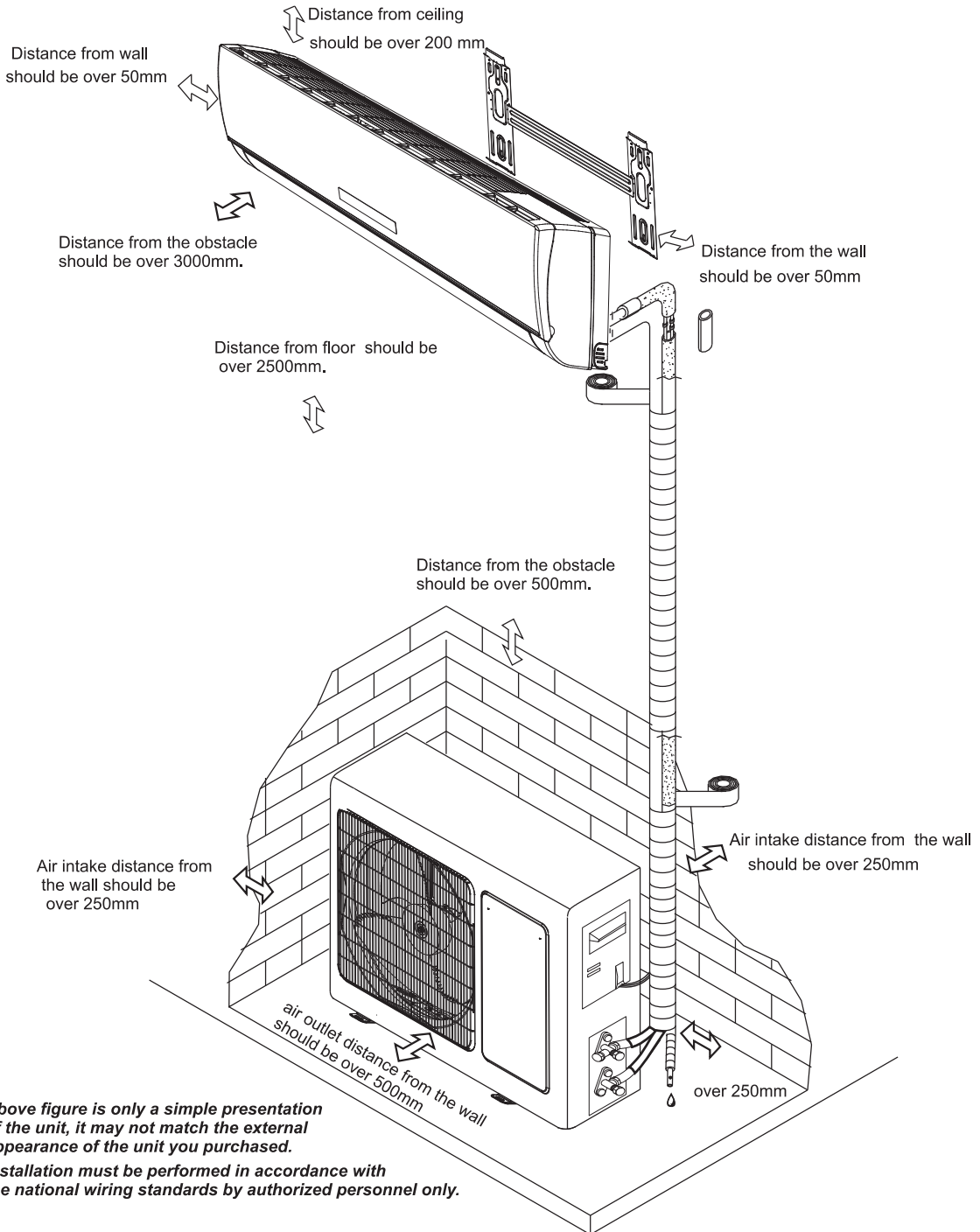

- Above figure is only a simple presentation of the unit, it may not match the external appearance of the unit you purchased.
- Installation must be performed in accordance with the national wiring standards by authorized personnel only.

Installation instructions

Select the installation locations

Location for Installing Indoor Unit

- Where there is no obstacle near the air outlet and air can be easily blown to every corner.
- Where piping and wall hole can be easily arranged.
- Keep the required space from the unit to the ceiling and wall according to the installation diagram on previous page.
- Where the air filter can be easily removed.
- Keep the unit and remote controller 1m or more apart from television, radio etc.
- To prevent the effects of a fluorescent lamps, keep as far as possible.
- Do not put anything near the air inlet to obstruct it from air absorption.
- Where there is strong enough to bear the weight and is not tend to increase operation noise and vibration.

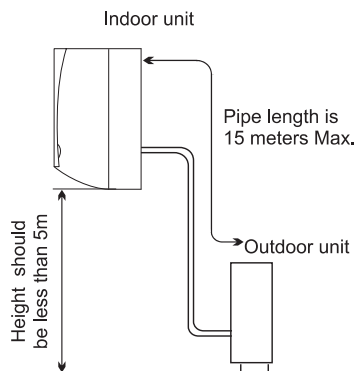

Location for Installing Outdoor Unit

- Where it is convenient to install and well ventilated.
- Avoid installing it where flammable gas could leak.
- Keep the required distance apart from the wall.
- The pipe length between indoor and outdoor unit should be not more than 5 meters in factory default status, but it can go up to maximum 15 meters with additional refrigerant charge.
- Keep the outdoor unit away from a place of greasy dirt, vulcanization gas exit.
- Avoid installing it at the roadside where there is a risk of muddy water.
- A fixed base where is not subject to increasing operation noise.
- Where there is not any blockage for air outlet.

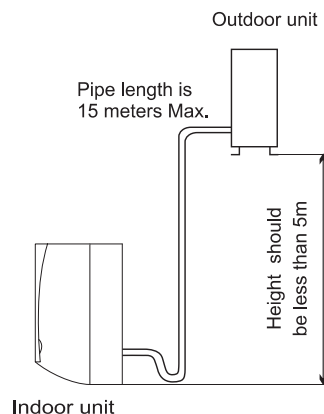

Model	Max. allowed pipe length without additional refrigerant (m)	Limit of pipe length (m)	Limit of Elevation Difference H (m)	Required amount of additional refrigerant (g/m)
5K~18K	5	15	5	20
21K~24K	5	15	5	30
28K~36K	5	15	5	40

If the height or pipe length is out of the scope of the table, please consult the merchant.

Installation instructions

Indoor unit installation

1. Installing the Mounting Plate

- Decide an installing location for the mounting plate according to the indoor unit location and piping direction.
- Keep the mounting plate horizontally with a horizontal ruler or dropping line.
- Drill holes of 32mm in depth on the wall for fixing the plate.
- Insert the plastic plugs to the hole, fix the mounting plate with tapping screws.
- Inspect if the mounting plate is well fixed. Then drill a hole for piping.

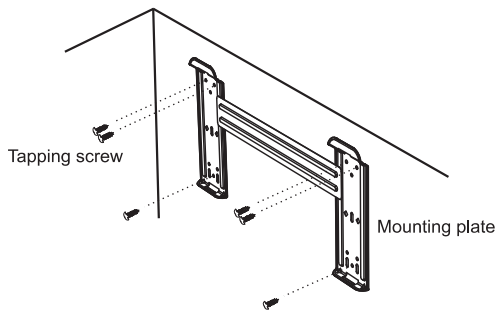

Note: The shape of your mounting plate may be different from the one above, but the installation method is similar.

Note: As the above figure shown, the six holes matched with tapping screw on the mounting plate must be used to fix the mounting plate, the others are prepared.

2. Drill a Hole for Piping

- Decide the position of hole for piping according to the location of mounting plate.
- Drill a hole on the wall. The hole should tilt a little downward toward outside.
- Install a sleeve through the wall hole to keep the wall tidy and clean.

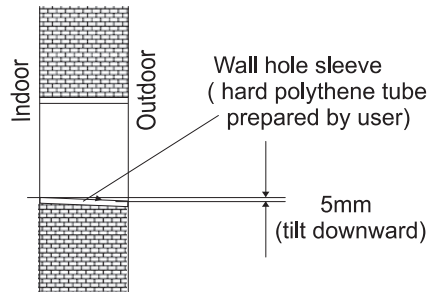

3. Indoor Unit Piping Installation

- Put the piping (liquid and gas pipe) and cables through the wall hole from outside or put them through from inside after indoor piping and cables connection complete so as to connect to outdoor unit.
- Decide whether saw the unloading piece off in accordance with the piping direction.(as shown below)

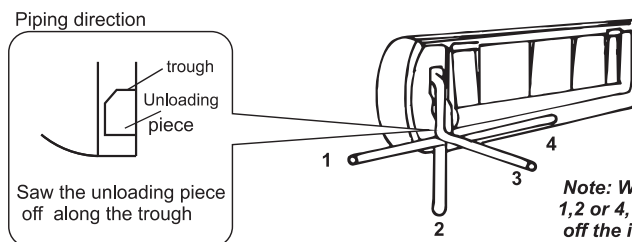

Note: When installing the pipe at the directions 1,2 or 4, saw the corresponding unloading piece off the indoor unit base.

- After connecting piping as required, install the drain hose. Then connect the power cords. After connecting, wrap the piping, cords and drain hose together with thermal insulation materials.

Installation instructions



- **Piping Joints Thermal Insulation:** Wrap the piping joints with thermal insulation materials and then wrap with a vinyl tape.

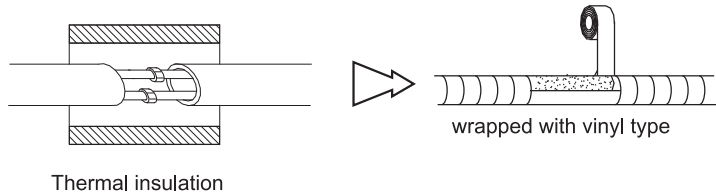

- **Piping Thermal Insulation:**

- Place the drain hose under the piping.
- Insulation material uses polythene foam over 6mm in thickness.
Note: Drain hose is prepared by user.

- Drain pipe should point downward for easy drain flow. Do not arrange the drain pipe twisted, sticking out or wave around, do not immerse the end of it in water.

If an extension drain hose is connected to the drain pipe, make sure to thermal insulated when passing along the indoor unit.

- When the piping is directed to the right, piping, power Cord and drain pipe should be thermal insulated and fixed onto the back of the unit with a piping fixer.

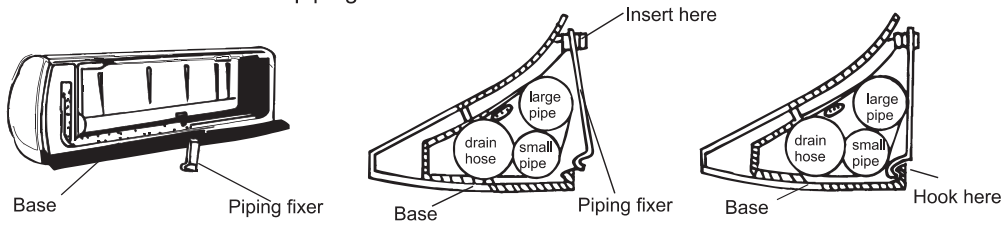
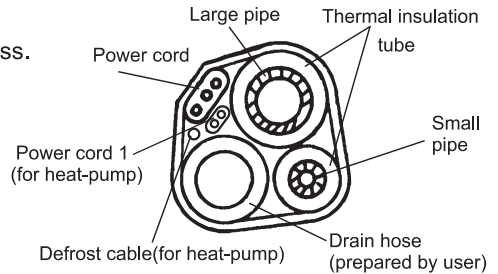

A. Insert the pipe fixer to the slot.

B. Press to hook the pipe fixer onto the base.

Piping Connection:

- Before unscrewing the big and the small sealing caps, press the small sealing cap with the finger until the exhaust noise stops, and then loosen the finger.
- Connect indoor unit pipes with two wrenches. Pay special attention to the allowed torque as shown below to prevent the pipes, connectors and flare nuts from being deformed and damaged.
- Pre-tighten them with fingers at first, then use the wrenches.

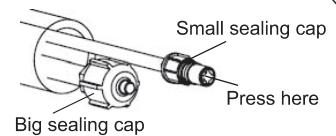

- If you don't hear the exhaust noise, please contact with the merchant.

Model	Pipe size	Torque	Nut width	Min.thickness
5,7,8,9,10,12,14,15,18,24K	Liquid Side (ϕ 6mm or 1/4 inch)	15~20N·m	17mm	0.5mm
18K [#] ,22,24K [#] ,28,30,36K	Liquid Side (ϕ 9.53mm or 3/8 inch)	30~35N·m	22mm	0.6mm
5,7,8,9,10K	Gas Side (ϕ 9.53mm or 3/8 inch)	30~35N·m	22mm	0.6mm
12,14,15,18K	Gas Side (ϕ 12mm or 1/2 inch)	50~55N·m	24mm	0.6mm
18K [#] ,22,24,28,30,36K	Gas Side (ϕ 16mm or 5/8 inch)	60~65N·m	27mm	0.6mm
36K [#]	Gas Side (ϕ 19mm or 3/4 inch)	70~75N·m	32mm	1.0mm

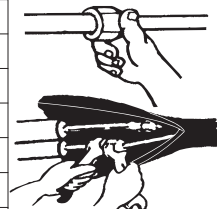

Note: The unit of 18K[#],24K[#],36K[#] is bigger than the unit of 18K,24K,36K.

Installation instructions

4. Connecting of the Cable

• Indoor Unit

Connect the power connecting cord to the indoor unit by connecting the wires to the terminals on the control board individually in accordance with the outdoor unit connection.

Note: For some models, it is necessary to remove the cabinet to connect to indoor unit terminal.

• Outdoor Unit

- 1). Remove the access door from the unit by loosening the screw. Connect the wires to the terminals on the control board individually as the following.
- 2). Secure the power connecting cord onto the control board with cable clamp.
- 3). Reinstall the access door to the original position with the screw.
- 4) Use a recognized circuit breaker for 24K model or above between the power source and the unit.
A disconnecting device to adequately disconnected all supply lines must be fitted.

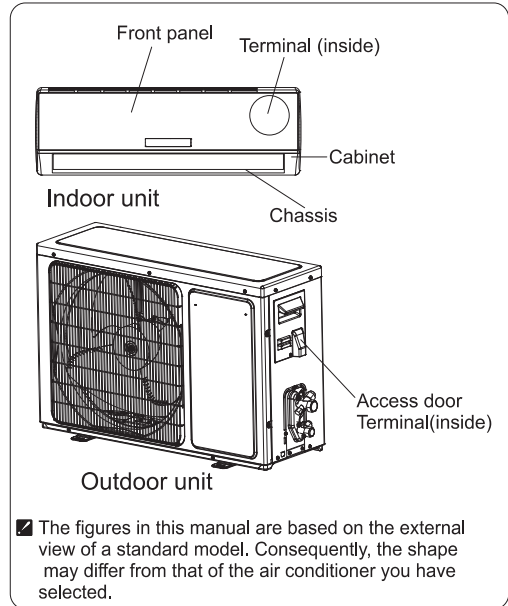

Caution:

1. Never fail to have an individual power circuit specifically for the air conditioner. As for the method of wiring, refer to the circuit diagram posted on the inside of the access door .
2. Confirm that the cable thickness is as specified in the power source specification.
3. Check the wires and make sure that they are all tightly fastened after cable connection.
4. Be sure to install an earth leakage circuit breaker in wet or moist area.

Cable Specifications

Capacity (Btu/h)	Power cord		Power connecting cord		Power connecting cord1		Main power supply
	Type	Normal cross-sectional area	Type	Normal cross-sectional area	Type	Normal cross-sectional area	
5K~13K	H05VV-F	0.75~1.5mm ² X3	H07RN-F H05RN-F	1.5mm ² X3 0.75~1.0mm ² X3	H05RN-F	0.75mm ² X2 (Heat-pump)	To indoor
14K~24K	H05VV-F	1.5~2.5mm ² X3	H07RN-F	1.5~2.5mm ² X3	H05RN-F	0.75mm ² X2 (Heat-pump)	To indoor
18K~30K	H05VV-F	1.5~2.5mm ² X3	H07RN-F	1.5~2.5mm ² X4	H05RN-F	0.75mm ² X2 (Heat-pump&Optional)	To indoor
18K~30K	H07RN-F	2.5mm ² X3	H05RN-F H07RN-F	1.0mm ² X3 1.0mm ² X4 Cooling only	H05RN-F	0.75mm ² X3 (Heat-pump)	To outdoor
24K~36K	H07RN-F	2.5~4.0mm ² X3	H05RN-F H07RN-F	0.75mm ² X4 1.0mm ² X4	H05RN-F	0.75mm ² X2 (Heat-pump&Optional)	To outdoor
24K~36K	H07RN-F	1.5mm ² X5	H05RN-F	0.75mm ² X4	H05RN-F	0.75mm ² X2 (Heat-pump)	To outdoor

The cord may be different from the list above. It may be used as the next list. And it can be larger.

0-6A, use 0.75mm² or 18AWG. 0-10A, use 1mm² or 16AWG. 0-16A, use 1.5mm² or 14AWG.

0-20A, use 2.5mm² or 14AWG. 0-25A, use 2.5mm² or 12AWG. 0-32A, use 4mm².

Installation instructions

Wiring Diagram

Warning: Before obtaining access to terminals, all supply circuits must be disconnected.

Note: All the wires may be different colors. The indicators '1L 2L 3L' may be '4 5 6' or others. And the terminal may be different from the material object.

• 5K~24K Model

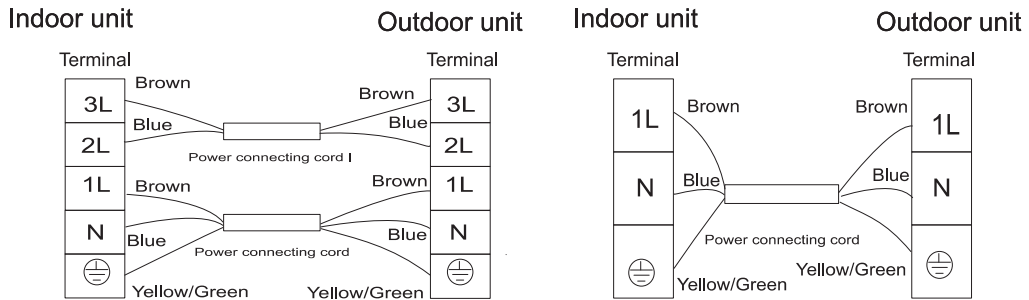

For above models, the power supply are connected from indoor unit.
For these models, the ground wire may be connected to the electric box directly.

• 18K~30K Model

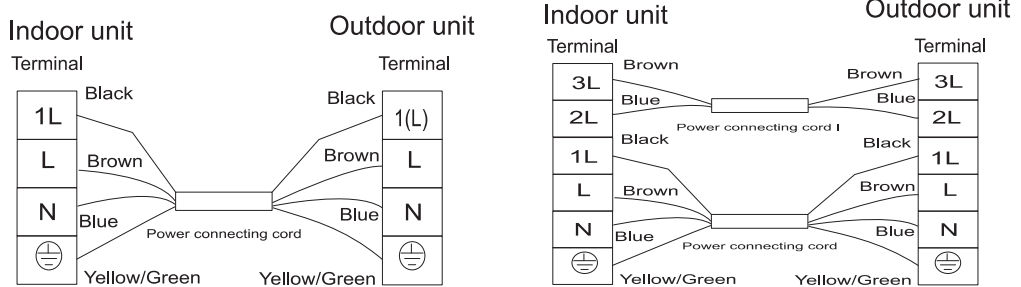

For above models, the power supply are connected from indoor unit.
For these models, the ground wire may be connected to the electric box directly.

• 18K~30K Model

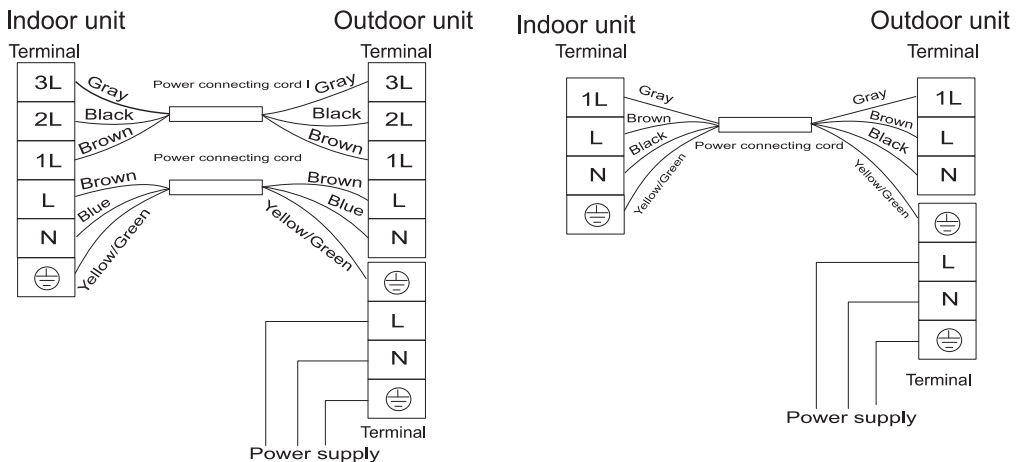

For these models, the power supply are connected from outdoor unit, with a circuit breaker.

Installation instructions

Warning: Before obtaining access to terminals, all supply circuits must be disconnected.

Note: All the wires may be different colors. The indicators '1L 2L 3L' may be '4 5 6' or others.

And the terminal may be different from the material object.

• 24K~36K Model

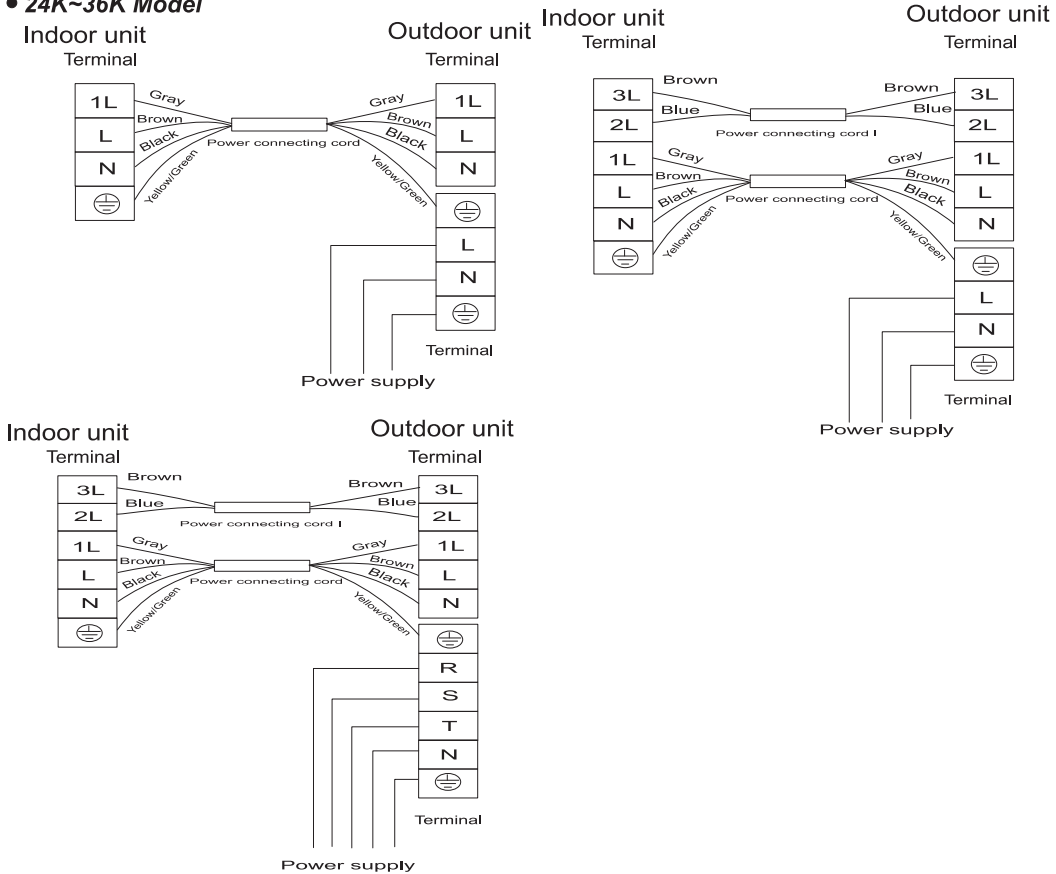

For these models, the power supply are connected from outdoor unit, with a circuit breaker. All the wires may be different colors.

• Defrost cable (for heat-pump air conditioner only ,and it`s an optional part)

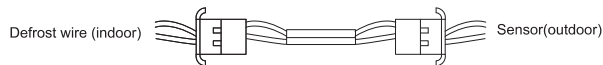

After connection, the defrost wire should be well wrapped with a wrapping tape and the connector should be put inside the unit.

• Overheat protection or high pressure protection cable (it`s an optional part)



After connection, the wire should be well wrapped with a wrapping tape and the connector should be put inside the unit.

• Ionizer (The ionizer is an optional part)

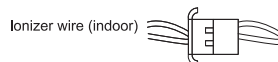

After connection, the ionizer will work automatically .

Installation instructions

Outdoor unit installation

1. Install Drain Port and Drain Hose (for heat-pump model only)

The condensate drains from the outdoor unit when the unit operates in heating mode. In order not to disturb your neighbor and protect the environment, install a drain port and a drain hose to direct the condensate water. Just install the drain port and rubber washer to the chassis of the outdoor unit, then connect a drain hose to the port as the right figure shown.

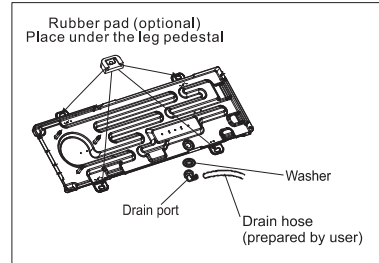

2. Install and Fix Outdoor Unit

Fix with bolts and nuts tightly on a flat and strong floor.

If installed on the wall or roof, make sure to fix the supporter well to prevent it from shaking due to serious vibration or strong wind.

3. Outdoor Unit Piping Connection

- Remove the valve caps from the 2-way and 3-way valve.
- Connect the pipes to the 2-way and 3-way valves separately according to the required torque.

4. Outdoor Unit Cable Connection (see previous page)

Air purging

The air which contains moisture remaining in the refrigeration cycle may cause a malfunction on the compressor. After connecting the indoor and outdoor units, release air and moisture from the refrigerant cycle using a vacuum pump, as shown below.

Note: To protect the environment, be sure not to discharge the refrigerant to the air directly.

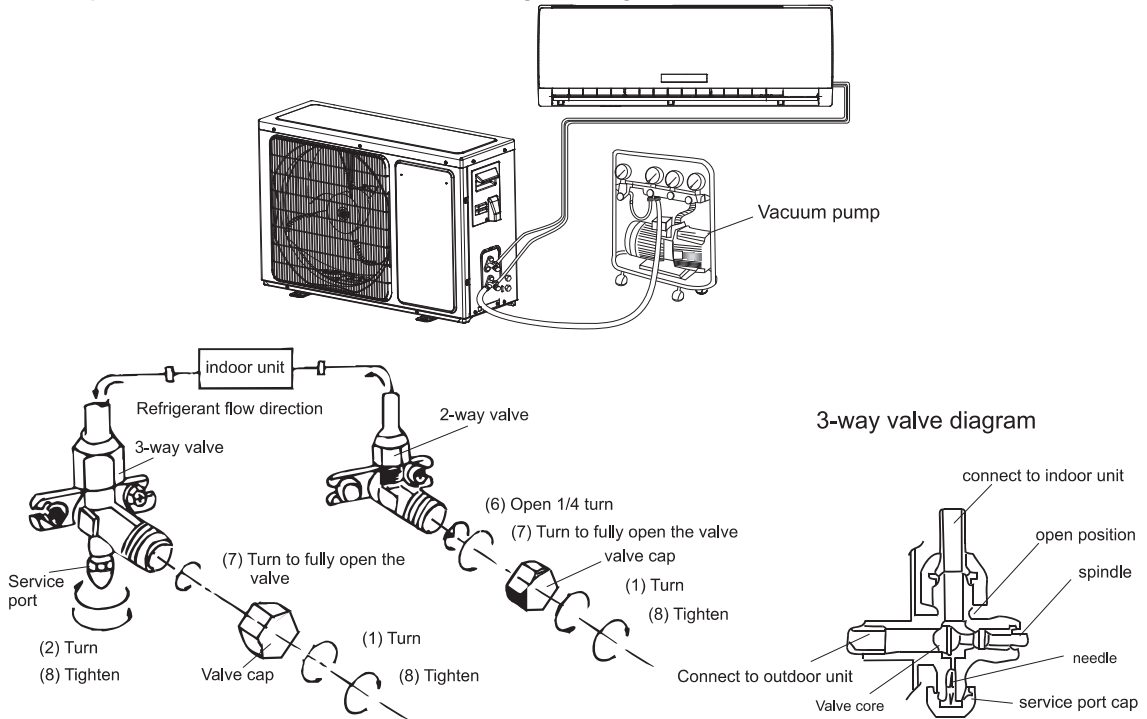





Installation instructions

How to Purge Air Tubes:

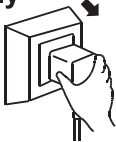
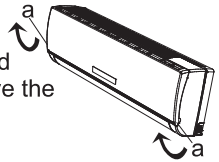

- (1). Unscrew and remove caps from 2 and 3-way valves.
- (2). Unscrew and remove cap from service valve.
- (3). Connect vacuum pump flexible hose to the service valve.
- (4). Start vacuum pump for 10-15 minutes until reaching a vacuum of 10 mm Hg absolutes.
- (5). With vacuum pump still running close the low pressure knob on vacuum pump manifold. Then stop vacuum pump.
- (6). Open 2-way valve 1/4 turn then close it after 10 seconds. Check tightness of all joints using liquid soap or an electronic leak detector.
- (7). Turn 2 and 3-way valves stem to fully open the valves. Disconnect vacuum pump flexible hose.
- (8). Replace and tighten all valve caps.

Maintenance

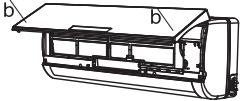
◆ Front panel maintenance

<p>1 Cut off the power supply</p> <p>Turn off the appliance first before disconnecting from power supply.</p> 	<p>2</p> <p>Grasp position "a" and pull outward to remove the front panel.</p> 
<p>3 Wipe with a soft and dry cloth.</p> <p>Use soft moisture cloth to clean if the front panel is very dirty;</p>  <p>Use a dry and soft cloth to clean it.</p>	<p>4 Never use volatile substance such as gasoline or polishing powder to clean the appliance.</p> 
<p>5 Never sprinkle water onto the indoor unit</p>  <p>Dangerous! Electric shock!</p>	<p>6 Reinstall and shut the front panel.</p> <p>Reinstall and shut the front panel by pressing position "b" downward.</p> 

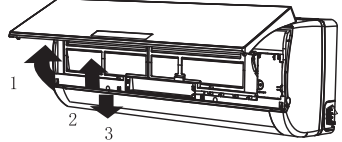
◆ Air filter maintenance

<p>1 Stop the appliance, cut off the power supply and remove the air filter.</p>  <ol style="list-style-type: none"> 1. Open the front panel. 2. Press the handle of the filter gently from the front. 3. Grasp the handle and slide out the filter. 	<p>2 Clean and reinstall the air filter.</p> <p>If the dirt is conspicuous, wash it with a solution of detergent in lukewarm water. After cleaning, dry well in shade.</p> 
<p>3 Close the front panel again.</p> <p>☑ <i>Clean the air filter every two weeks if the air conditioner operates in an extremely dusty environment.</i></p>	<p>It is necessary to clean the air filter after using it for about 100 hours.</p>

Protection

◆ Operating condition

The protective device maybe trip and stop the appliance in the cases listed below.

HEATING	Outdoor air temperature is over 24°C
	Outdoor air temperature is below -7°C
	Room temperature is over 27°C

COOLING	Outdoor air temperature is over *43°C
	Room temperature is below 21°C
DRY	Room temperature is below 18°C

**For Tropical (T3) Climate condition models, the temperature point is 55°C instead of 43°C .
The temperature of some products is allowed beyond the range. In specific situation, please consult the merchant.
If the air conditioner runs in COOLING or DRY mode withdoor or window opened for a long time when relative humidity is above 80%,dew may drip down from the outlet.*

◆ Noise pollution

- Install the air conditioner at a place that can bear its weight in order to operate more quietly.
- Install the outdoor unit at a place where the air discharged and the operation noise would not annoy your neighbors.
- Do not place any obstacles in front of the air outlet of the outdoor unit lest it increases the noise level.

◆ Features of protector

1. The protective device will work at following cases.

- Restarting the unit at once after operation stops or changing mode during operation, you need to wait for 3 minutes.
- Connect to power supply and turn on the unit at once, it may start 20 seconds later.

2. If all operation has stopped, press **ON/OFF** button again to restart, Timer should be set again if it has been canceled.

◆ Features of HEATING mode

Preheat

At the beginning of the HEATING operation, the airflow from the indoor unit is discharged 2-5 minutes later.

Defrost

In **HEATING** operation the appliance will defrost (de-ice) automatically to raise efficiency. This procedure usually lasts 2-10 minutes. During defrosting, fans stop operation. After defrosting completes, it returns to **HEATING** mode automatically.

Note: Heating is NOT available for cooling only air conditioner models.

Troubleshooting

The following cases may not always be a malfunction, please check it before asking for service.

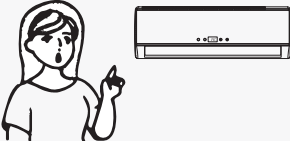
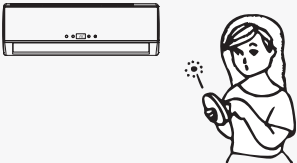
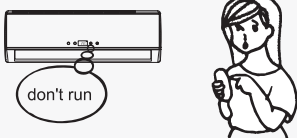
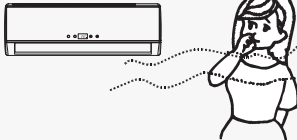
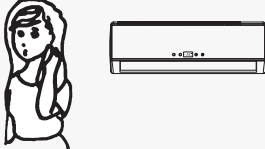
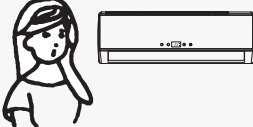
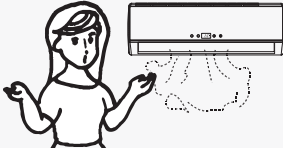
Trouble	Analysis
<p>Does not run</p> 	<ul style="list-style-type: none"> • If the protector trip or fuse is blown. • Please wait for 3 minutes and start again, protector device may be preventing unit to work. • If batteries in the remote controller exhausted. • If the plug is not properly plugged.
<p>No cooling or heating air</p> 	<ul style="list-style-type: none"> • Is the air filter dirty? • Are the intakes and outlets of the air conditioner blocked? • Is the temperature set properly?
<p>Ineffective control</p> 	<ul style="list-style-type: none"> • If strong interference (from excessive static electricity discharge, power supply voltage abnormality) presents, operation will be abnormal. At this time, disconnect from the power supply and connect back 2-3 seconds later.
<p>Does not operate immediately</p> 	<ul style="list-style-type: none"> • Changing mode during operation, 3 minutes will delay.
<p>Peculiar odor</p> 	<ul style="list-style-type: none"> • This odor may come from another source such as furniture, cigarette etc, which is sucked in the unit and blows out with the air.
<p>A sound of flowing water</p> 	<ul style="list-style-type: none"> • Caused by the flow of refrigerant in the air conditioner, not a trouble. • Defrosting sound in heating mode.
<p>Cracking sound is heard</p> 	<ul style="list-style-type: none"> • The sound may be generated by the expansion or contraction of the front panel due to change of temperature.
<p>Spray mist from the outlet</p> 	<ul style="list-style-type: none"> • Mist appears when the room air becomes very cold because of cool air discharged from indoor unit during COOLING or DRY operation mode.
<p>The compressor indicator (red) lights on constantly, and indoor fan stops.</p>	<ul style="list-style-type: none"> • The unit is shifting from heating mode to defrost. The indicator will lights off within ten minutes and returns to heating mode.

Identification of parts

Indoor unit

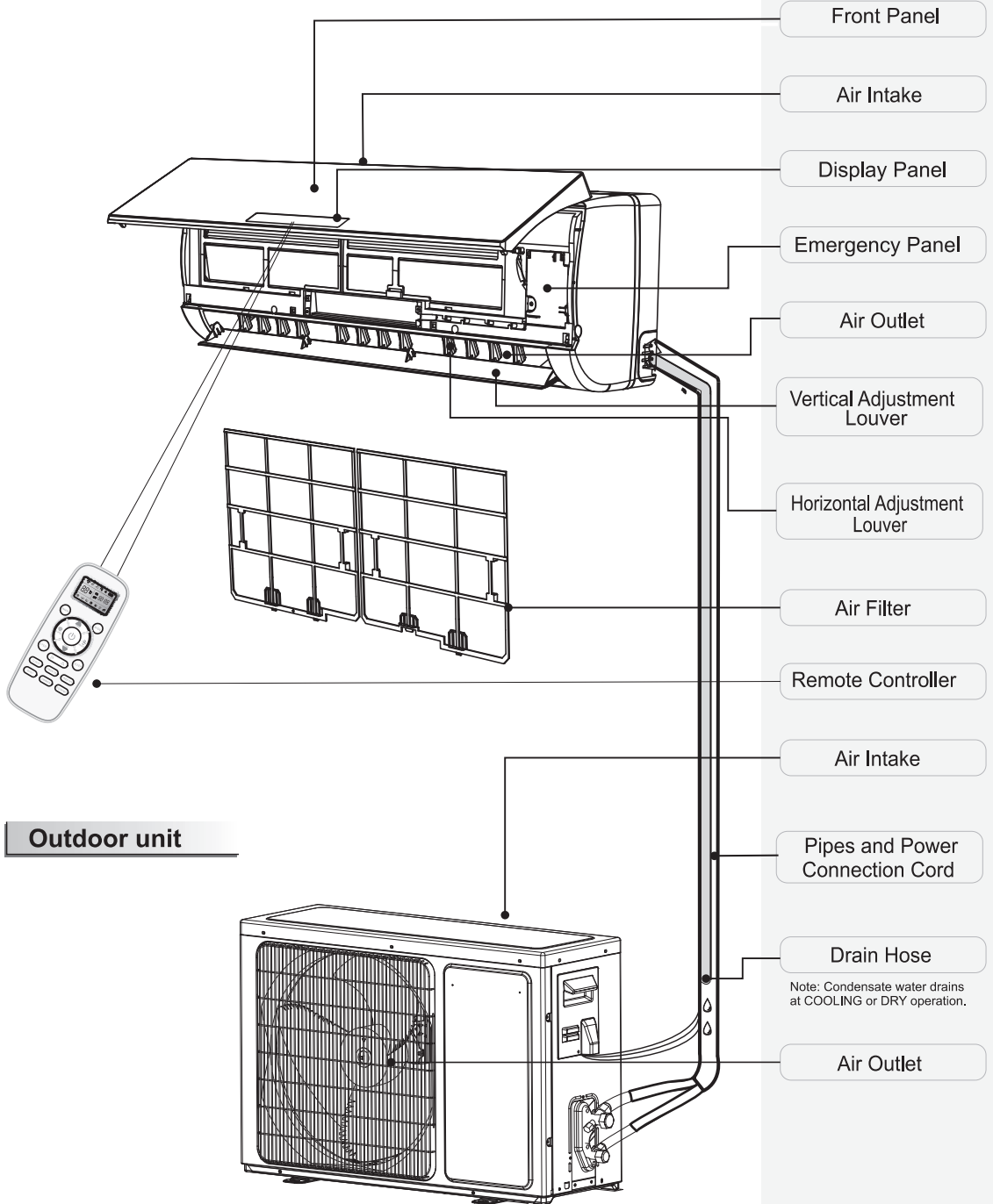









Outdoor unit

- Front Panel
- Air Intake
- Display Panel
- Emergency Panel
- Air Outlet
- Vertical Adjustment Louver
- Horizontal Adjustment Louver
- Air Filter
- Remote Controller
- Air Intake
- Pipes and Power Connection Cord
- Drain Hose
- Air Outlet

Note: Condensate water drains at COOLING or DRY operation.

☑ The figures in this manual are based on the external view of a standard model. Consequently, the shape may differ from that of the air conditioner you have selected.

Display introduction

	<p>Temperature indicator 1</p> <p>Display set temperature. It shows FC after 200 hours of usage as reminder to clean the filter. After filter cleaning press the filter reset button located on the indoor unit behind the front panel in order to reset the display.(optional)</p>
	<p>Running indicator 2</p> <p>It lights up when the AC is running. It flashes during defrosting.</p>
	<p>Timer indicator 3</p> <p>It lights up during set time.</p>
	<p>Sleep indicator 4</p> <p>It lights up in sleep mode.</p>
	<p>Compressor indicator 5</p> <p>It lights up when the compressor is on.</p>
	<p>Mode indicator 6</p> <p>Heating displays orange,others display white</p>
	<p>Fan speed indicator 7</p>
	<p>Signal Receptor 8</p>
	<p>Smart WIFI indicator 9</p> <p>It lights up during WIFI is on.</p>
	<p>FAN ONLY mode indicator 10</p> <p>It lights up in FAN ONLY mode.</p>

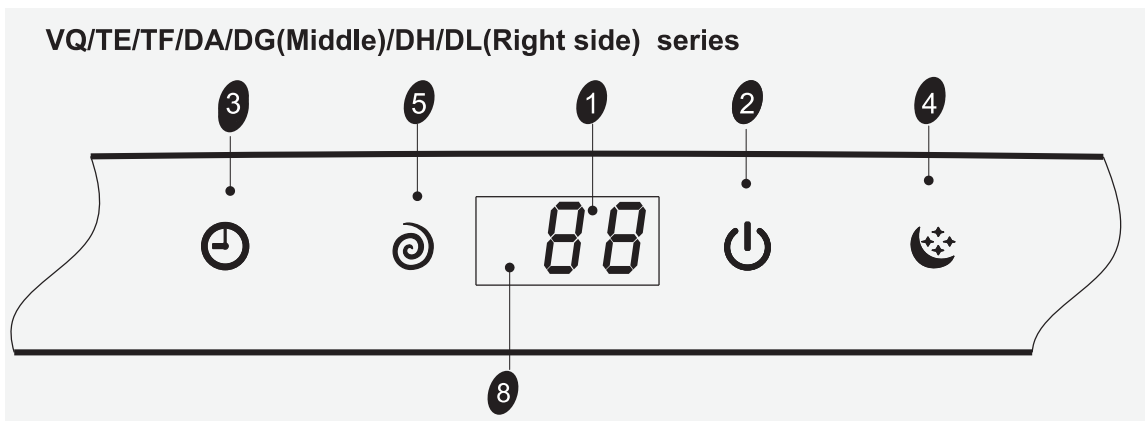

☑ The symbols may be different from these models, but the functions are similar.

Display introduction

VT series

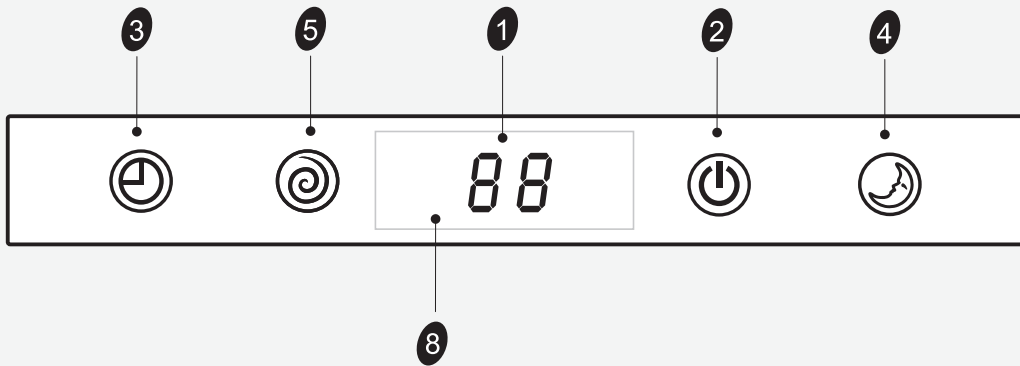

DG(Right side) series

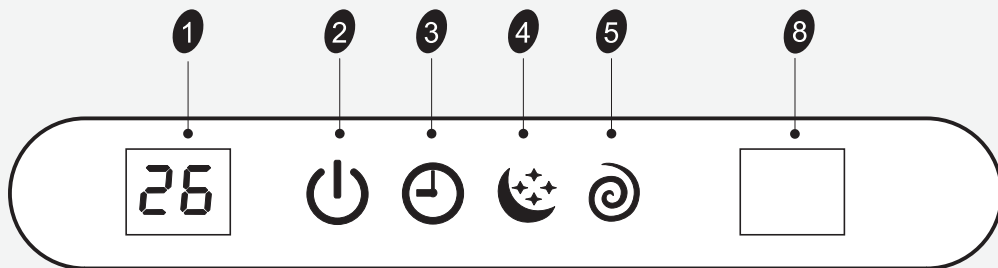

DE series

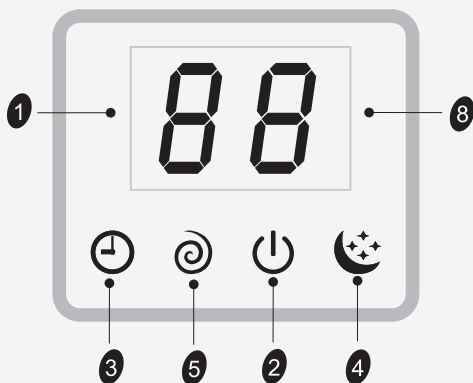

DF series

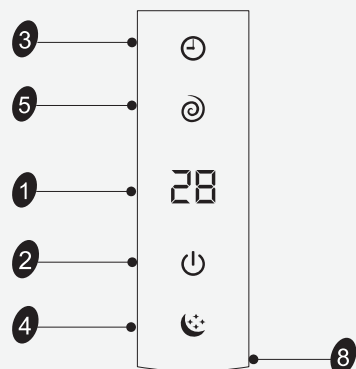

☑ The symbols may be different from these models, but the functions are similar.

Display introduction

TA series

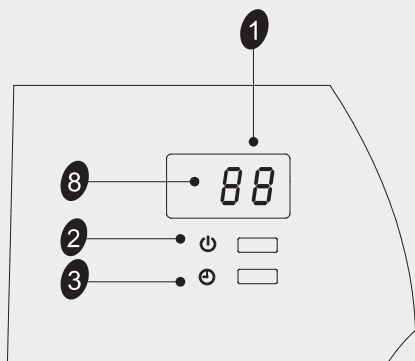

TQ/TR series

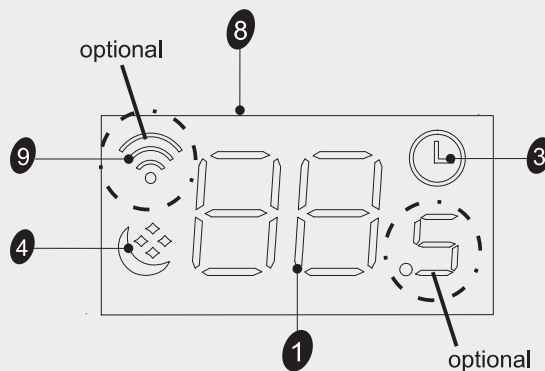

TD/TG/TS/TT/DB/DC/DJ/DK/DN/TV
DH(Hidden display)/DL(Middle) series

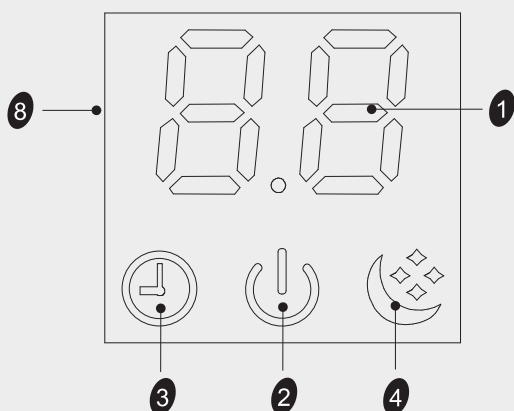

SC series

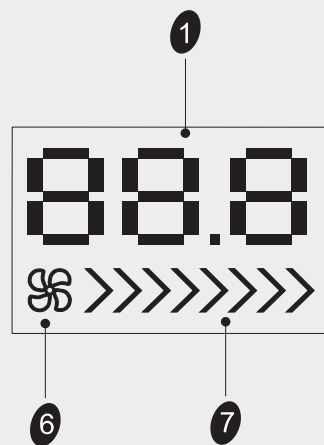

TL series

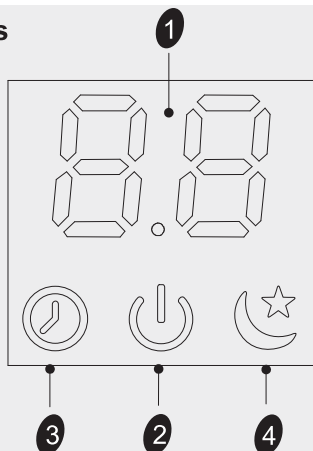

☑ The symbols may be different from these models, but the functions are similar.

Hisense

UPUTSTVO ZA UPOTREBU I UGRADNJU

Hvala što ste se odlučili za kupovinu ovog klima uređaja. Pažljivo pročitajte ovo uputstvo za upotrebu i ugradnju pre ugradnje i upotrebe ovog uređaja, a uputstvo čuvajte za buduće potrebe.

Sadržaj

Bezbednosna uputstva.....	1
Priprema pre upotrebe	2
Mere bezbednosti	3
Pregled delova	4
Unutrašnja jedinica	4
Spoljašnja jedinica.....	4
Prikazi na displeju.....	5
Održavanje.....	6
Zaštita.....	7
Defektaža.....	8
Uputstva za ugradnju	
Šema ugradnje	9
Odabir mesta za ugradnju.....	10
Ugradnja unutrašnje jedinice	11
Ugradnja spoljašnje jedinice	16
Čišćenje vazduhom.....	16

Uputstva za rukovanje daljinskim upravljačem. Videti „Uputstvo za daljinski upravljač“.

Bezbednosna uputstva

- Da biste obezbedili pravilan rad uređaja, pažljivo pročitajte uputstvo pre ugradnje, a ugradnju izvršite isključivo u skladu sa ovim uputstvom.
- Vazduh ne sme da dospe u rashladni sistem, niti se rashladno sredstvo sme ispuštati prilikom pomeranja klima uređaja.
- Pravilno povežite klima uređaj na uzemljenje.
- Pre priključivanja klima uređaja na napajanje pažljivo proverite da li su električni kablovi i cevi ispravni i dobro pričvršćeni.
- Mora postojati vazdušni prekidač.
- Nakon ugradnje, korisnik mora pravilno upravljati klima uređajem u skladu sa ovim uputstvom, imati odgovarajuće skladište za buduće održavanje i premeštaj klima uređaja.
- Tip osigurača koji se koristi kod kontrolera unutrašnje jedinice je Ø5mm X 20mm, specifikacija T 3.15A 250V AC.
- U uputstvima za ugradnju uređaja koji će biti stalno povezani na trajni razvod, a imaju struju curenja koja može biti veća od 10 mA, treba da bude navedeno da se preporučuje ugradnja uređaja za rezidualnu struju (RCD) sa nazivnom radnom rezidualnom strujom koja nije veća od 30 mA.
- Upozorenje: strujni udar može izazvati povrede ili smrt; pre servisiranja isključiti sva daljinska napajanja.
- Maksimalna dužina cevi između unutrašnje i spoljašnje jedinice treba da bude manja od 5 metara. Ukoliko je razmak veći od navedene dužine, to će uticati na efikasnost klima uređaja.
- Ovaj uređaj mogu koristiti deca uzrasta od 8 i više godina i osobe sa nižim fizičkim, čulnim i mentalnim sposobnostima ili osobe bez iskustva i znanja uz nadzor ili uputstva za bezbednu upotrebu uređaja i uz poznavanje mogućih opasnosti. Deca ne treba da se igraju ovim uređajem. Deca ne smeju da obavljaju čišćenje i održavanje bez nadzora.
- Baterije iz daljinskog upravljača se moraju reciklirati ili pravilno odložiti. Odlaganje otpadnih baterija — baterije bacati kao sortirani komunalni otpad u odgovarajući kontejner.
- Ako je priključen na trajni razvod, uređaj mora biti opremljen sredstvom kojim se kontakt svih polova razdvaja čime se obezbeđuje potpuno isključenje u uslovima prenapona kategorije III, a ovo sredstvo mora biti u sklopu trajnog razvoda i u skladu sa pravilima ožičenja.
- Ako se kabl napajanja ošteti, isti mora da zameni proizvođač, njegov ovlašćeni serviser ili slično kvalifikovano osoblje kako bi se izbegla opasnost.
- Uređaj treba ugraditi u skladu da nacionalnim propisima o priključivanju električnih uređaja.
- Ugradnju klima uređaja mogu sa vrše samo stručna i kvalifikovana lica.
- Uređaj se ne sme ugraditi u vešernici.

Priprema pre upotrebe

Napomena

- Sistem se puni rashladnim sredstvom u tečnom stanju ako je rashladno sredstvo za uređaj R22 ili R410A. U suprotnom, hemijski sastav rashladnog sredstva (R22 ili R410A) unutar sistema može da se promeni i na taj način utiče na rad klima uređaja.
- U skladu sa svojstvima rashladnog sredstva (R410A, vrednost GWP je 2088), pritisak u cevi je veoma visok i zbog toga morate biti pažljivi prilikom ugradnje i servisiranja uređaja.
- Ako se priključni kabl ošteti, isti mora da zameni proizvođač, njegov ovlašćeni serviser ili slično kvalifikovano lice kako bi se izbegla opasnost.
- Ugradnju klima uređaja može da vrši samo stručni inženjer.
- Temperatura rashladnog kola će biti visoka i zbog toga je neophodno držati kabl za međusobno povezivanje dalje od bakarne cevi.

Postavke

Pre upotrebe klima uređaja, obavezno izvršiti proveru i podešavanje prema datom u nastavku.

- **Podešavanje daljinskog upravljača**
Posle svake zamene baterija daljinskog upravljača ili uključivanjem, vrši se automatsko podešavanje toplotne pumpe putem daljinskog upravljača. Ako je klima uređaj koji ste kupili predviđen samo za hlađenje, može se koristiti i daljinski upravljač za toplotnu pumpu.
- **Funkcija pozadinskog svetla (opciono)**
Držite pritisnutim bilo koje dugme na daljinskom upravljaču u trajanju od oko 2 sekunde i pozadinsko svetlo će se uključiti. Isto se automatski isključuje posle oko 10 sekundi.
- **Podešavanje automatskog restartovanja**
Klima uređaj ima funkciju automatskog restartovanja.
Ovu funkciju možete aktivirati ili otkazati kada klima uređaj radi.
 - Držite pritisnutim dugme za brzo uključivanje/isključivanje (ON/OFF) u trajanju od nekoliko sekundi i ova funkcija će se aktivirati pri čemu ćete čuti dva zvučna signala. Ako čujete samo jedan zvučni signal, to znači da ste deaktivirali ovu funkciju.

Zaštita životne sredine

Ovaj uređaj je napravljen od materijala koji se može reciklirati ili ponovo upotrebljavati. Odlaganje se mora vršiti u skladu sa lokalnim propisima o odlaganju otpada. Pre odlaganja, obavezno odseći kabl za mrežno napajanje, tako da se uređaj ne može ponovo koristiti.

Za više informacija o rukovanju i recikliranju ovog proizvoda, obratite se lokalnim organima koji su zaduženi za odvojeno prikupljanje otpada ili prodavnicu u kojoj ste kupili uređaj.

ODLAGANJE UREĐAJA

Ovaj uređaj je obeležen u skladu sa evropskom Direktivom 2012/19/EZ, Električni i elektronski otpad (WEEE).

Ove oznake ukazuju na to da proizvod ne treba odlagati zajedno sa drugim komunalnim otpadom u EU. Da biste sprečili moguće narušavanje životne sredine ili zdravlja čoveka usled nekontrolisanog odlaganja otpada, postupite odgovorno i reciklirajte ovaj proizvod kako biste promovisali ponovnu upotrebu materijala. Da biste upotrebljavani uređaj vratili, koristite sisteme za vraćanje i sakupljanje ili se obratite prodavcu kod koga ste kupili ovaj proizvod. Oni ga mogu preuzeti radi reciklaže bezbedne po životnu sredinu.



Mere predostrožnosti

Simboli u Uputstvu za upotrebu i održavanje se tumače na sledeći način:

 Zabranjeno.

 Uzemljenje je obavezno.

 Pažnja.

 Upozorenje: nepravilno rukovanje može dovesti do ozbiljne opasnosti, kao što je smrt, teška povreda itd.

 Koristiti odgovarajuće napajanje u skladu sa zahtevima specifikacije. U suprotnom može doći do ozbiljnih kvarova ili opasnosti ili požara.





 Prekidač ili utikač napajanja redovno čistiti od prašine. Pravilno i dobro pričvrstite priključni kabl na uređaj da ne bi došlo do strujnog udara ili požara zbog slabog kontakta.





 Ne koristiti prekidač napajanja ili ne izvlačiti utikač radi isključivanja uređaja u toku rada, jer može doći do požara usled varničenja itd.

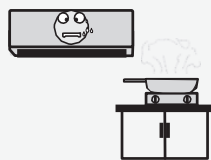

 Korisnik snosi odgovornost za uzemljenje uređaja u skladu sa lokalnim propisima ili uputstvima ovlašćenog tehničara.

 Duže direktno izlaganje hladnom vazduhu je štetno po vaše zdravlje. Preporučuje se protok vazduha kroz celu prostoriju.





 Vazduh koji se izduvava ne sme doći u kontakt sa plinskim ringlama i štednjacima.



 Ne dodirivati dugmad za upravljanje mokrim rukama.



 U slučaju nepravilnog rada, uređaj najpre isključiti putem daljinskog upravljača, a tek onda isključiti napajanje.

 Ni u kom slučaju ne zabijati štap ili sličnu prepreku u jedinicu. Ventilator se okreće velikom brzinom, tako da može doći do povrede.



 Nemojte sami popravljati uređaj. Nepravilna popravka može dovesti do strujnog udara itd.



 Ne ostavljati predmete na spoljašnjoj jedinici.



 Priključni kabl ne sme da se zaplete, vuče, niti pritiska, jer se tako može oštetiti. Strujni udar ili požar je obično rezultat neispravnog priključnog kabla.

Pregled delova

Unutrašnja jedinica

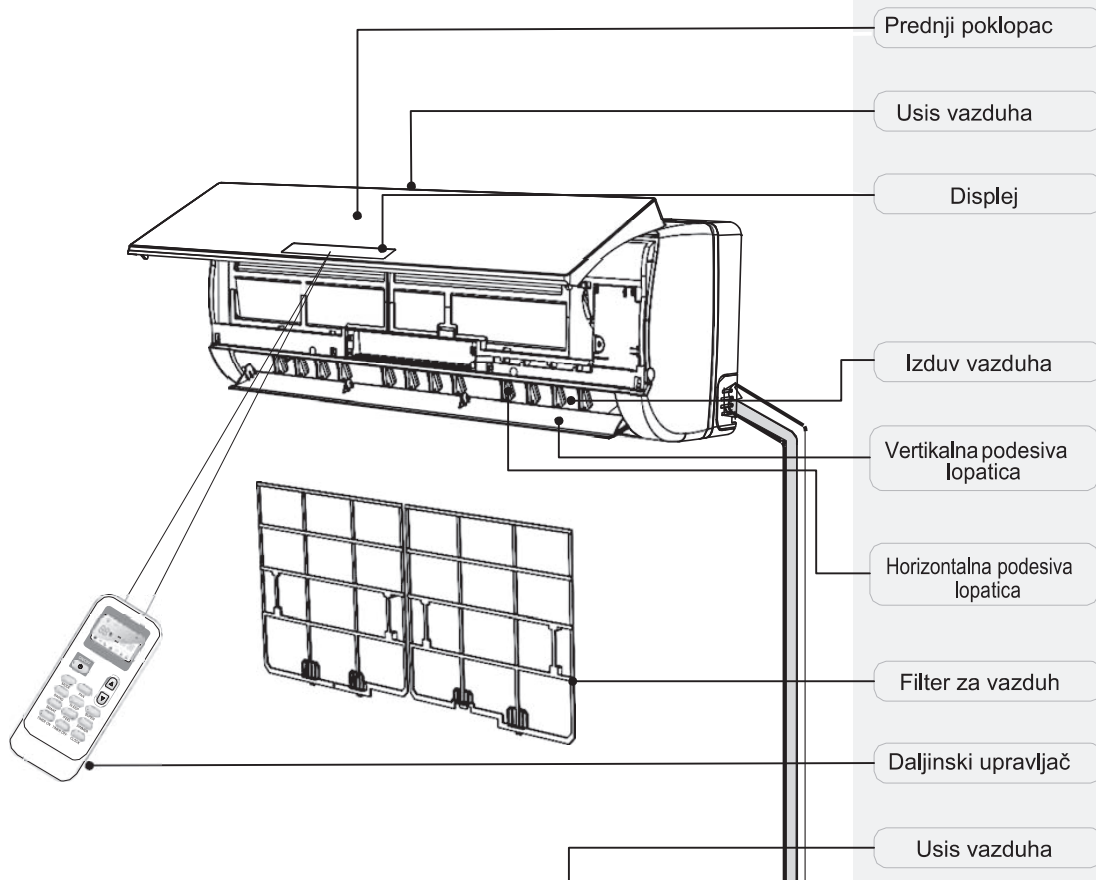

Spoljašnja jedinica

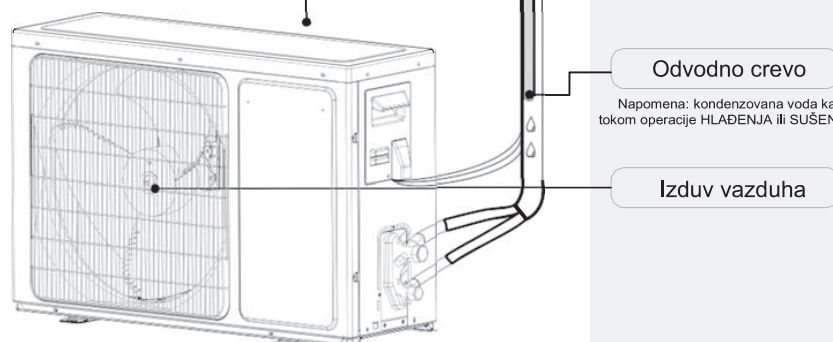

Napomena: kondenzovana voda kaplje tokom operacije HLADENJA ili SUŠENJA.

Na slikama iz ovog uputstva je prikazan spoljašnji izgled standardnog modela. Zbog toga se oblik klima uređaja koji ste odabrali može razlikovati.

Prikazi na displeju

Indikator temperature

88

Prikazuje podešenu temperaturu.
Prikazuje oznaku „FC“ nakon 200 sati korišćenja označavajući da je potrebno čišćenje filtera. Posle čišćenja filtera pritisnite dugme na unutrašnjoj jedinici iza prednjeg poklopca kako biste resetovali displej (opciono).
Prikazuje podešenu vlažnost u režimu vlažnosti. (opciono)



Run



Timer



Sleep



Comp.



Indikator rada

Pali se kada naizmenična struja prolazi kroz uređaj. Treperi prilikom odmrzavanja.

Indikator vremena

Pali se kada je podešeno vreme.

Indikator režima spavanja

Pali se u režimu spavanja.

Indikator kompresora

Pali se kada je kompresor uključen.

Indikator režima super

Pali se u režimu super.

Indikator režima

Grejanje se prikazuje narandžastom, a ostalo belom bojom

Indikator brzine ventilatora

Prijemnik signala

Indikator čišćenja filtera

Pali se kada je potrebno čišćenje filtera.

Pametni WIFI indikator

Pali se kada je uključen WIFI.

Indikator 6. udobnosti

Pali se u režimu 6. udobnosti.

Indikator vlažnosti

Pali se u režimu vlažnosti.

VG/VL serije

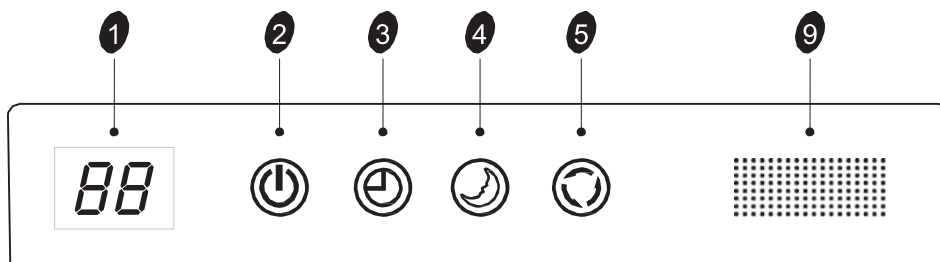

☑ Simboli mogu izgledati drugačije od simbola koji se prikazuju kod ovih modela, ali su funkcije slične.

Prikazi na displeju

VT serija

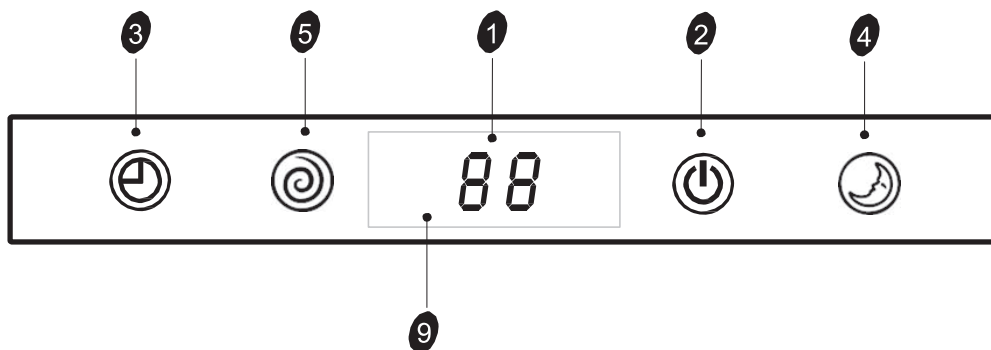

SF/DG(desna strana) serije

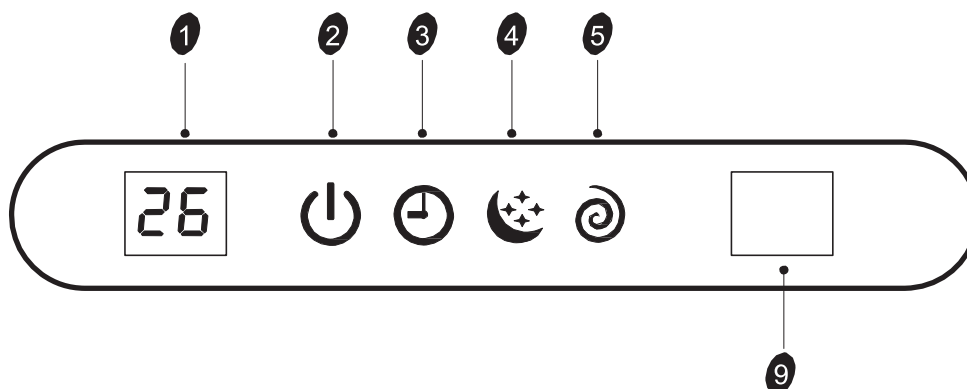

SE serija

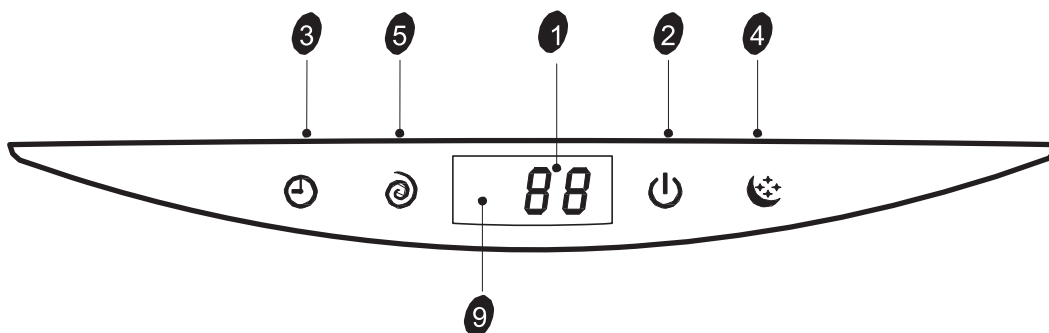

☑ Simboli mogu izgledati drugačije od simbola koji se prikazuju kod ovih modela, ali su funkcije slične.

Prikazi na displeju

NS/DE serije

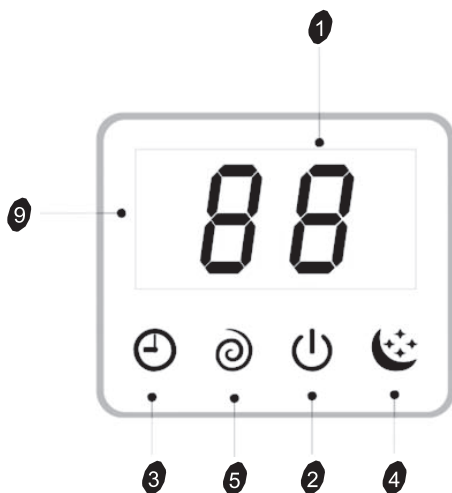

NT serija

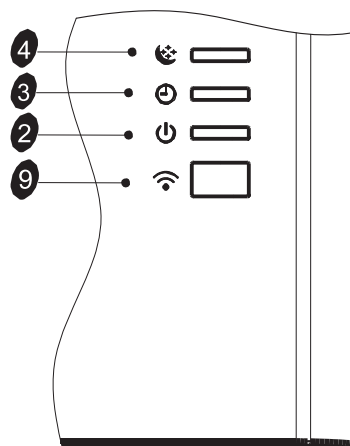

SH serija

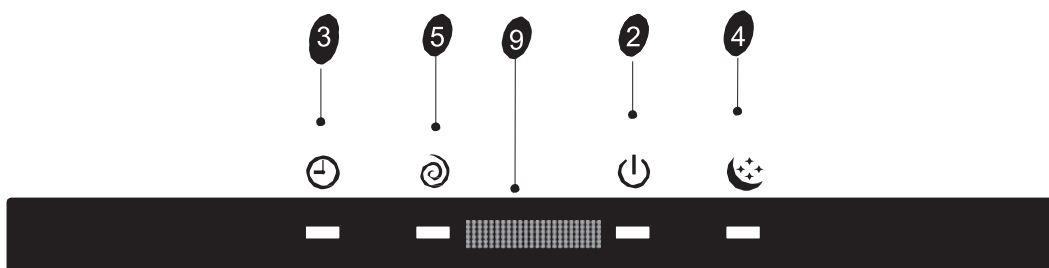

VQ/TE/TF/TK/DA/DG(sredina)/DH/SG serije

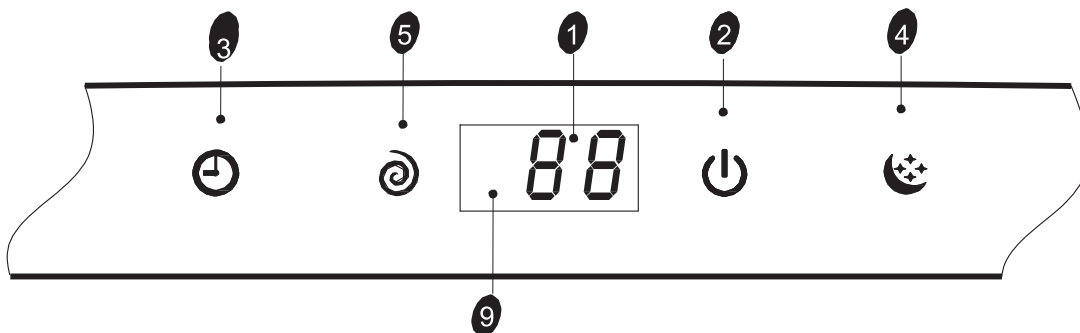

☑ Simboli mogu izgledati drugačije od simbola koji se prikazuju kod ovih modela, ali su funkcije slične.

Prikazi na displeju

VM serija

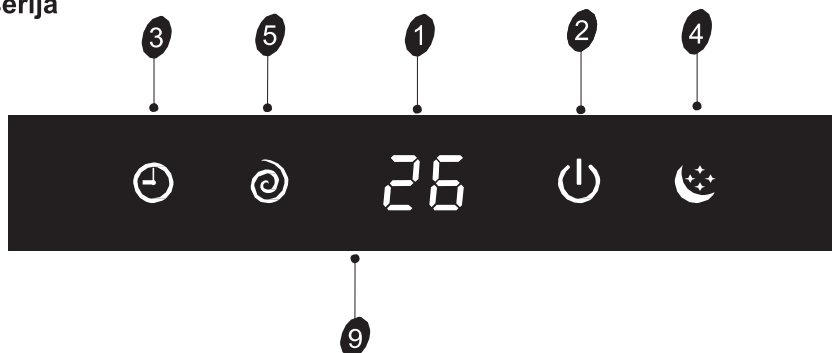

NM/DF serije

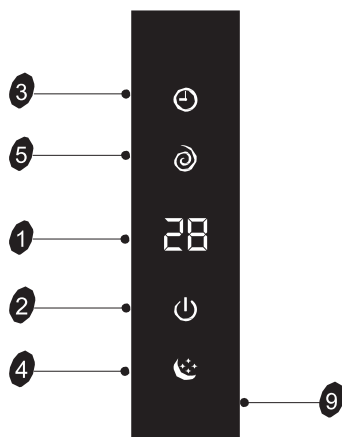

NK serija

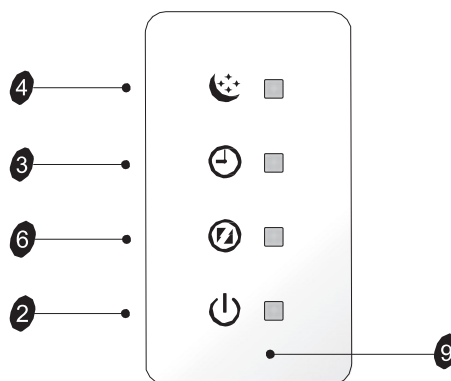

TA/TC serije

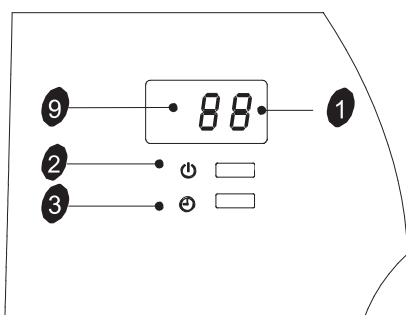

TM/TP serije

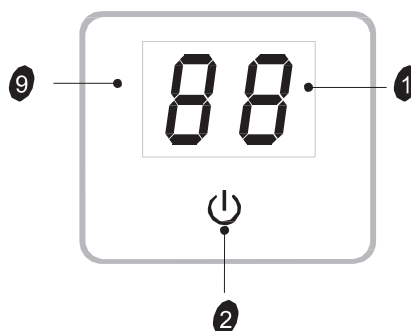

☑ Simboli mogu izgledati drugačije od simbola koji se prikazuju kod ovih modela, ali su funkcije slične.

Prikazi na displeju

TJ serija

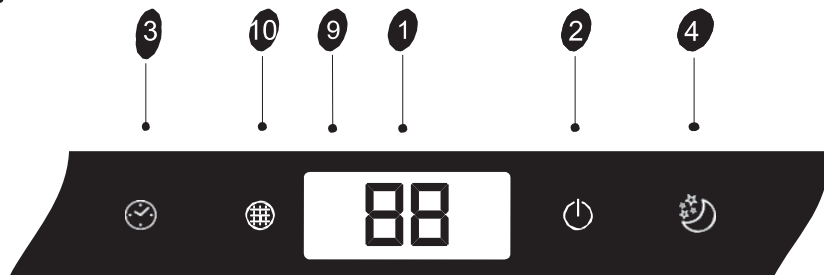

WLP serija:TJ (skriveni displej)

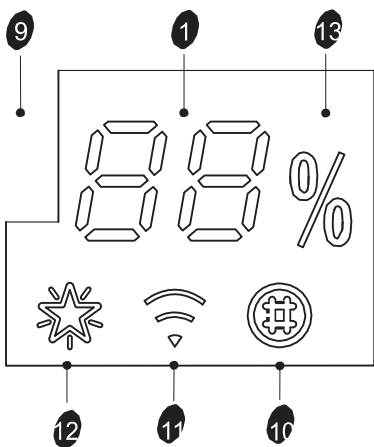
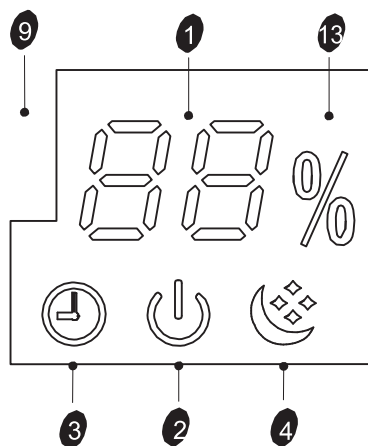
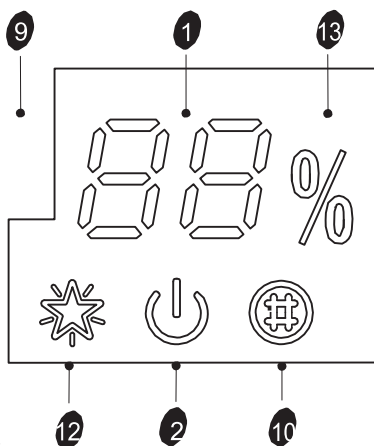

☑ Simboli mogu izgledati drugačije od simbola koji se prikazuju kod ovih modela, ali su funkcije slične.

Prikazi na displeju

WLP serija:TJ (skriveni displej)/DX/DB

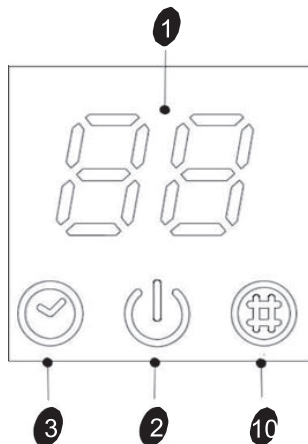

TL serija

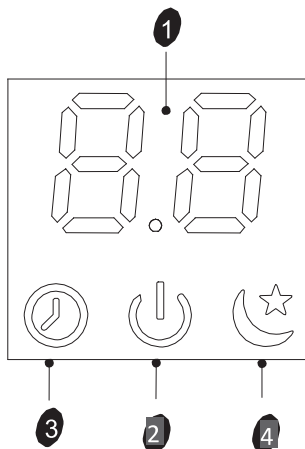

VC serija

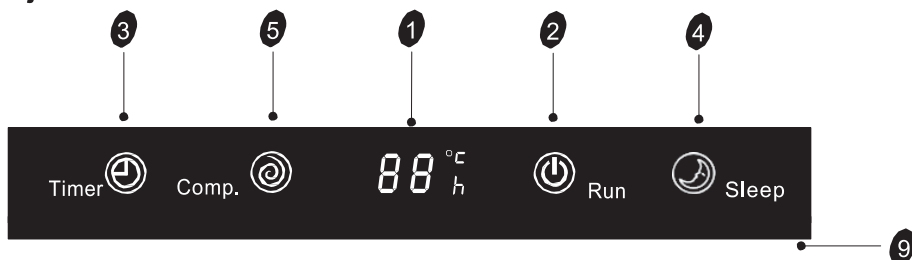

☑ Simboli mogu izgledati drugačije od simbola koji se prikazuju kod ovih modela, ali su funkcije slične.

Prikazi na displeju

(TL/TJ/TQ/TR/TU/TV/TP/TM/TU/DB/DC/DL/
DJ/DK/DX/KB/KG/LB)
/(CA/CB/CD/CE/KA) serija

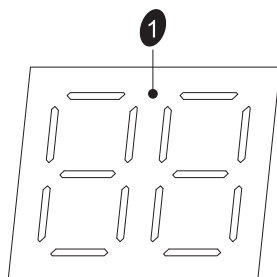

DA(za WLP) serija

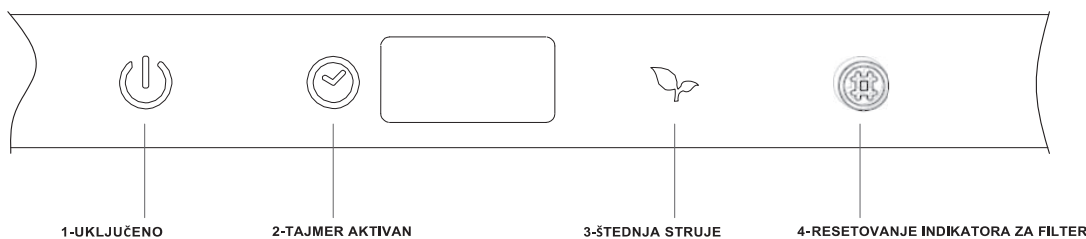

SA/TD/TG/DB/DC/DJ/DK/TV serije

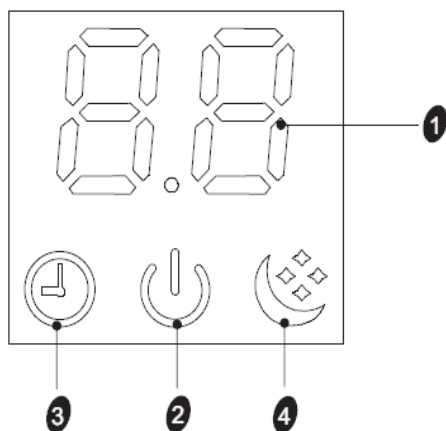

SC serija

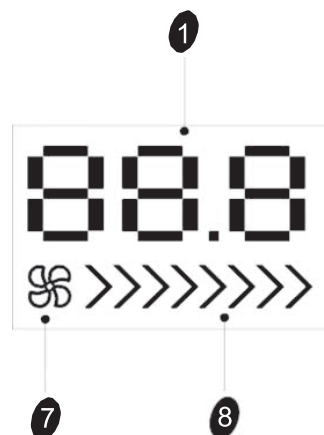

☑ Simboli mogu izgledati drugačije od simbola koji se prikazuju kod ovih modela, ali su funkcije slične.

Prikazi na displeju

DG(za WLP) serija

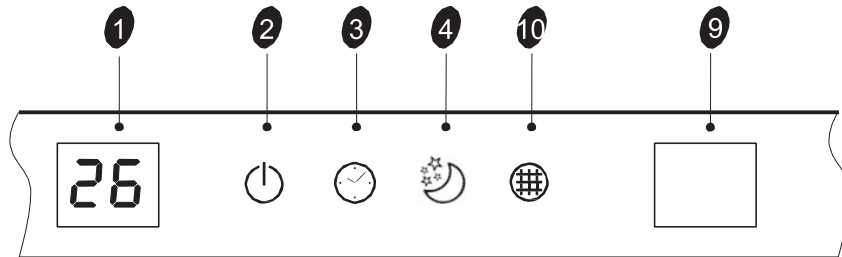

TQ/TR serije

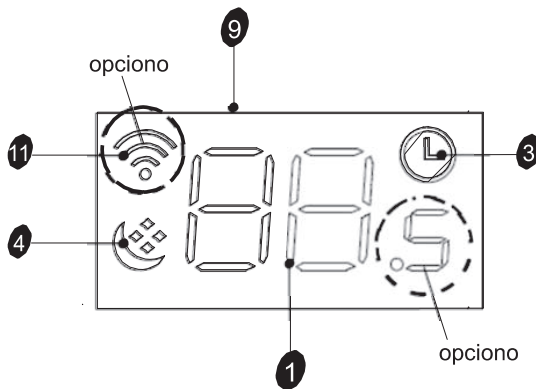

WLP TJ SERIJA

Dugme za brzo
uključenje/isključenje

ON/OFF Pritiskom na dugme, uređaj se uključuje/isključuje.

Dugme za resetovanje indikatora za fiter

Pritiskom na dugme resetuje se indikator za čišćenje filtera .

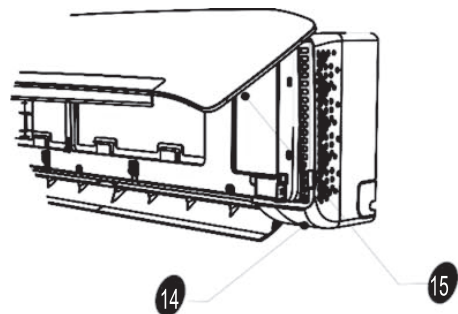

Dugme za brzo
uključenje/isključenje

ON/OFF Pritiskom na dugme, uređaj se uključuje/isključuje.

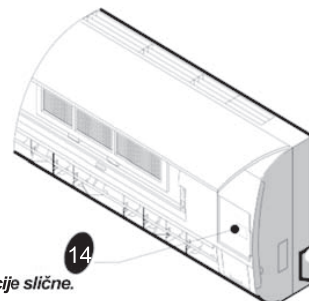



☑ Simboli mogu izgledati drugačije od simbola koji se prikazuju kod ovih modela, ali su funkcije slične.

Održavanje

♦ Održavanje prednjeg pokopca

<p>1 Isključite napajanje</p> <p>Prvo isključite uređaj, a zatim isključite napajanje.</p> 	<p>2</p> <p>Prihvatite poklopac u poziciji „a“ i povucite ga prema spolja kako biste ga skinuli.</p> 
<p>3 Obrišite mekom i suvom krpom.</p> <p>Koristite malo navlaženu krpu za čišćenje ako je prednji poklopac veoma zaprljan.</p>  <p>Koristite suhu i meku krpu za čišćenje.</p>	<p>4 Za čišćenje uređaja ni u kom slučaju ne koristiti lako isparljive supstance kao što su benzin i prah za poliranje.</p> 
<p>5 Unutrašnju jedinicu ni u kom slučaju ne prskati vodom</p> 	<p>6 Montirajte i zatvorite prednji poklopac</p> <p>Montirajte i zatvorite prednji poklopac pritiskom pozicije „b“ nadole.</p> 

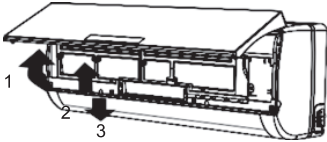
♦ Održavanje filtera za vazduh

<p>1 Isključite uređaj, isključite napajanje i izvadite filter za vazduh.</p>  <ol style="list-style-type: none">1. Otvorite prednji poklopac.2. Pažljivo pritisnite ručicu filtera sa prednje strane.3. Uхватite ručicu i izvucite filter.	<p>2 Očistite i postavite filter.</p> <p>Ako je filter voma zaprljan, operite ga rastvorom deterđenta i mlake vode. Posle čišćenja ostavite ga da se dobro osuši u hladu.</p> 
<p>3 Ponovo zatvorite prednji poklopac.</p> <p>☑ Čišćenje filtera je potrebno na svake dve nedelje ako klima uređaj radi u izuzetno prašnjavom okruženju.</p>	<p>Filter za vazduh čistiti nakon 100 sati upotrebe.</p>

Zaštita

Uslovi rada

Zaštitni uređaj može da isključi klima uređaj u sledećim slučajevima:

GREJANJE	Spoljašnja temp. vazduha je preko 24°C
	Spoljašnja temp. vazduha je ispod -7°C
	Sobna temperatura je preko 27°C
HLAĐENJE	Spoljašnja temp. vazduha je preko *43°C
	Sobna temperatura je ispod 21°C
SUŠENJE	Sobna temperatura je ispod 18°C

**Kod modela za uslove tropske klime (T3), temperatura isključenja iznosi 55°C umesto 43°C.*

Kod nekih proizvoda temperatura je dozvoljena van opsega. Za konkretnu situaciju konsultujte prodavca.

Kada klima uređaj radi u režimu HLAĐENJA ili SUŠENJA u prostoriji gde su vrata ili prozor duže vreme otvoreni i kada je relativna vlažnost veća od 80%, iz izduva vazduha može kapati voda.

Zagađenje bukom

- Ugradite klima uređaj na mesto koje može izdržati njegovu težinu kako bi mogao tiše da radi.
- Ugradite spoljašnju jedinicu na mesto gde vazduh koji se izduvava i buka usled rada uređaja neće smetati susedima.
- Ne postavljajte predmete ispred izduva vazduha spoljašnje jedinice da se nivo buke ne bi povećao.

Karakteristike zaštitnog uređaja

1 Zaštitni uređaj će raditi u sledećim slučajevima.

- U slučaju restartovanja jedinice odmah po isključenju ili promene režima tokom rada potrebno je sačekati 3 minuta.
- Povežite napajanje i odmah uključite jedinicu i počće da radi posle 20 sekundi.

2 Ako su sve funkcije isključene, pritisnite dugme **ON/OFF (UKLJUČENO/ISKLJUČENO)** kako biste restartovali uređaj, a tajmer je potrebno ponovo podesiti ako je bio isključen.

Karakteristike režima GREJANJA

Zagrevanje

Na početku operacije **GREJANJA**, unutrašnja jedinica počinje da duva nakon 2–5 minuta.



Odmrzavanje

Prilikom operacije **GREJANJA**, uređaj će se automatski odmrznuti kako bi se povećala efikasnost. Ova procedura traje 2–10 minuta. Tokom odmrzavanja ventilatori ne rade. Kada se odmrzavanje završi, uređaj se automatski prebacuje na režim **GREJANJA**.

Napomena: grejanje NIJE dostupno kod klima uređaja koji su predviđeni samo za hlađenje.

Defektaža

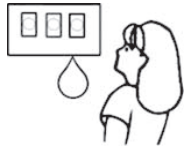
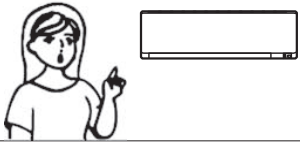
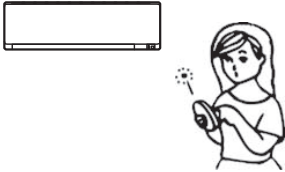
Sledeći slučajevi ne predstavljaju uvek neispravnost, te vas molimo da pre zahteva za servisiranje izvršite proveru.

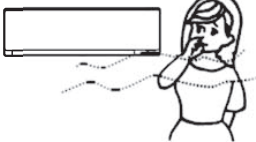
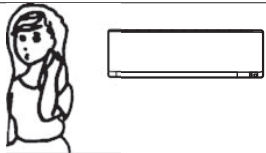
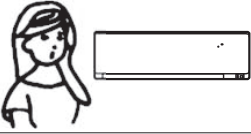
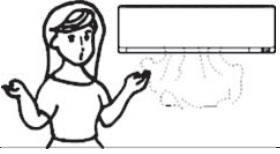
Problem	Analiza
<p>Uređaj ne radi</p> 	<ul style="list-style-type: none"> Zbog isključenja zaštitnim uređajem ili iskakanja osigurača Sačekajte 3 minuta i ponovo uključite uređaj Zbog praznih baterija u daljinskom upravljaču Zbog neodgovarajućeg priključivanja utikača
<p>Nema hladnog ili toplog vazduha</p> 	<ul style="list-style-type: none"> Da li je filter za vazduh zaprljan? Da li su zapušeni izduvi i usisi vazduha klima uređaja? Da li je temperatura pravilno podešena?
<p>Upravljač ne radi</p> 	<ul style="list-style-type: none"> U slučaju velikih smetnji (od prekomernog elektrostatičkog pražnjenja, neodgovarajućeg napona napajanja) rad će biti nepravilan. Tada je potrebno da isključite napajanje i uključite ga 2–3 sekunde kasnije.
<p>Ne počinje odmah sa radom</p> 	<ul style="list-style-type: none"> Prilikom promene režima, uređaj počinje da radi 3 minuta kasnije.
<p>Specifičan miris</p> 	<ul style="list-style-type: none"> Ovaj miris može da potiče od drugog izvora kao što je nameštaj, cigarete itd, a koji je jedinica usisala i sada izduvava zajedno sa vazduhom.
<p>Zvuk tekuće vode</p> 	<ul style="list-style-type: none"> Uzrok je protok rashladnog sredstva u klima uređaju, ne predstavlja kvar. Zvuk odmrzavanja u režimu grejanja.
<p>Čuje se pucketanje</p> 	<ul style="list-style-type: none"> Zvuk može biti posledica širenja ili skupljanja prednjeg poklopca usled promene temperature.
<p>Iz izduva se raspršuje magla</p> 	<ul style="list-style-type: none"> Magla se pojavljuje kada je vazduh u prostoriji veoma hladan zbog hladnog vazduha koji izduvava unutrašnja jedinica tokom režima HLADENJA ili SUŠENJA.
<p>Indikator kompresora (crvena lampica) je stalno uključen, a ventilator unutrašnje jedinice ne radi.</p>	<ul style="list-style-type: none"> Jedinica se prebacuje iz režima grejanja na odmrzavanje. Indikator se gasi u roku od deset minuta i uređaj počinje da radi u režimu grejanja.

Uputstva za ugradnju

Šema ugradnje

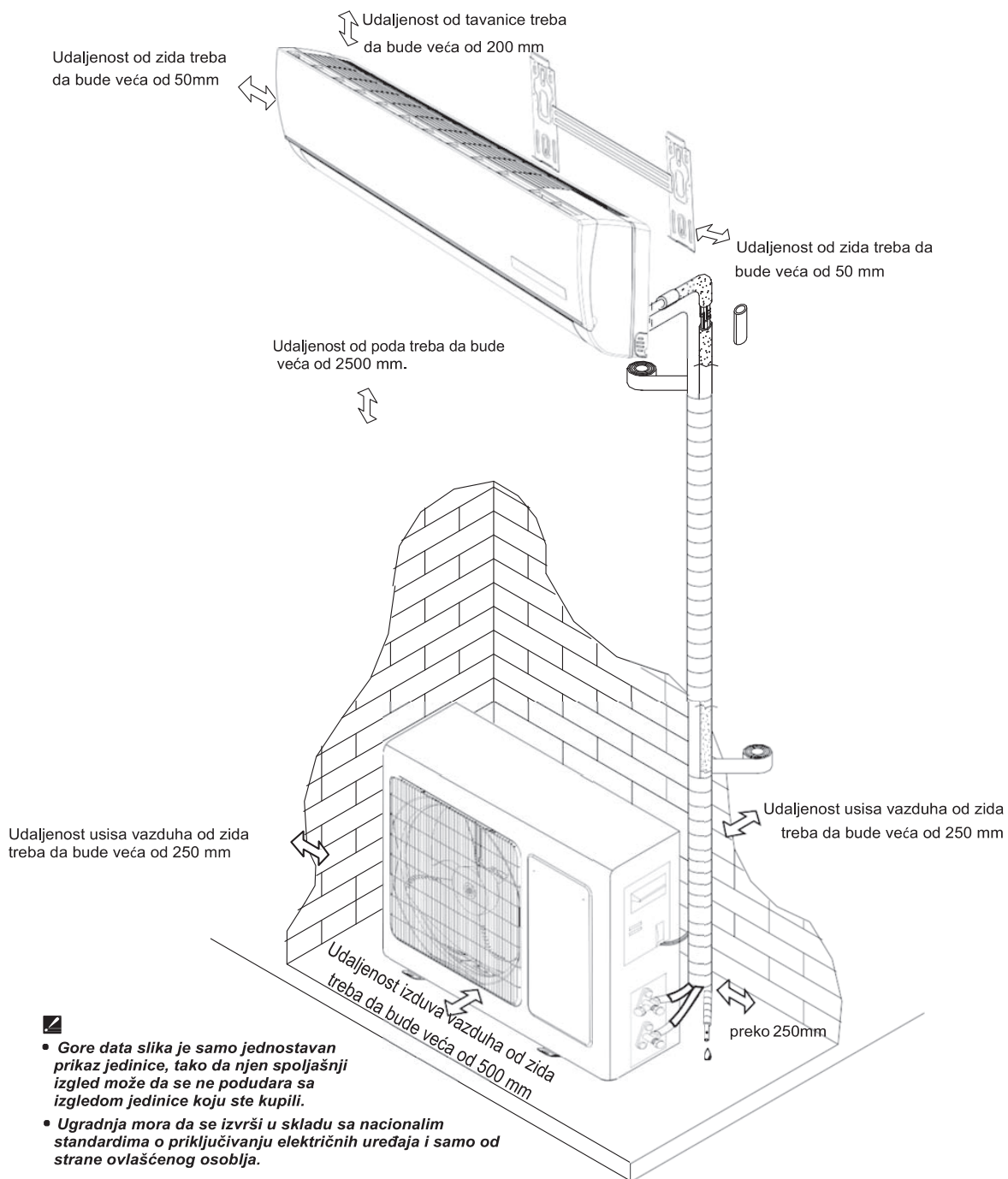

Uputstva za ugradnju

Odabir mesta za ugradnju

Mesto ugradnje unutrašnje jedinice

- Na mestu bez prepreka u blizini izduva vazduha kako bi vazduh mogao lako da dopre do svakog ugla.
- Na mestu gde se cevi mogu lako postaviti u rupi u zidu.
- Jedinicu postaviti na potrebnoj udaljenosti od tavanice i zida prema šemi ugradnje na prethodnoj strani.
- Na mestu gde se filter za vazduh može lako izvaditi.
- Jedinica i daljinski upravljač treba da budu udaljeni 1 m ili više od televizora, radija itd.
- Da biste sprečili uticaj fluorescentnih lampi, postavite ga što je dalje moguće.
- Ne postavljajte ništa u blizini usisa vazduha kako usisavanje vazduha ne bi imalo prepreke.
- Na mestu koje može da izdrži težinu jedinice i koje neće povećati buku i vibracije prilikom rada.

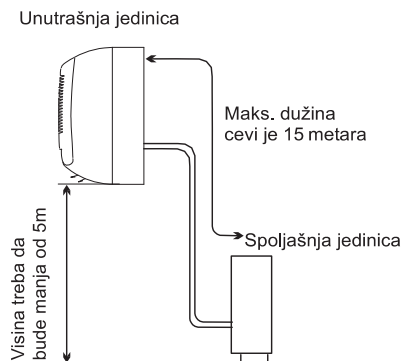

Mesto ugradnje spoljašnje jedinice

- Na mestu gde je ugradnja pogodna, sa dobrom ventilacijom.
- Izbegavati ugradnju na mestu gde zapaljivi gas može da curi.
- Postaviti na potrebnoj udaljenosti od zida.
- Razmak između unutrašnje i spoljašnje jedinice treba da bude 5 metara, a najviše 15 uz dopunu rashladnog sredstva.
- Spoljašnja jedinica ne sme da se nalazi u blizini mesta sa masnom prljavštinom, izlaza gasa za vulkanizaciju.
- Ne postavljati na strani puta gde postoji mogućnost prskanja blatnjavom vodom.
- Fiksirana osnova koja neće povećati buku uređaja dok radi.
- Na mestu bez prepreka izduva vazduha.

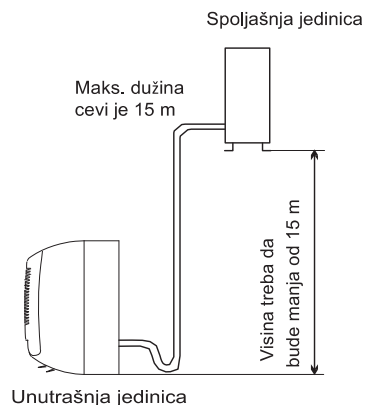

Model	Maks. dozvoljena dužina cevi pri isporuci (m)	Ograničenje dužine cevi (m)	Ograničenje visinske razlike H (m)	Potrebna dodatna količina rashladnog sredstva (g/m)
5K~18K	5	15	5	20
22K.24K	5	15	5	30
28K.30K.36K	5	15	5	40

Ako visina ili dužina cevi nije obuhvaćena tabelom, konsultujte prodavca.

Uputstva za ugradnju

Ugradnja unutrašnje jedinice

1. Ugradnja nosača

- Odredite mesto ugradnje nosača prema mestu ugradnje unutrašnje jedinice i smeru cevi.
- Nosač postavite horizontalno pomoću ravnog lenjira ili libele.
- Na zidu izbušite rupe dubine 32 mm za pričvršćivanje nosača.
- Postavite tiplove u rupu i pričvrstite nosač samobušećim vijcima.
- Proverite da li je nosač dobro pričvršćen. Posle toga izbušite rupu za cev.

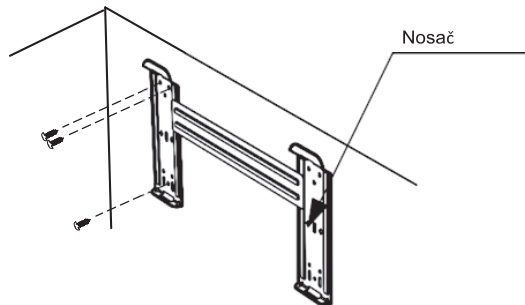

Napomena: oblik vašeg nosača se može razlikovati od oblika nosača na slici, ali je postupak ugradnje sličan.

2. Izbušite rupu za cev

- Odredite mesto rupe za cev prema mestu nosača.
- Izbušite rupu na zidu. Rupa treba da ima blagi pad prema spolja.
- Postavite rukavac kroz rupu u zidu kako bi zid bio uredan i čist.

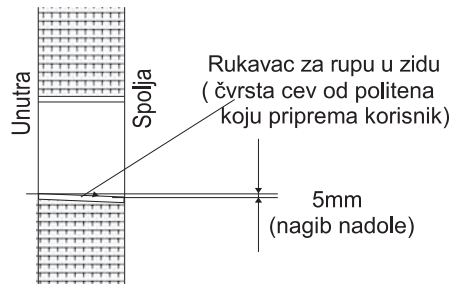

3. Ugradnja cevi unutrašnje jedinice

- Provcite cev (cev za tečnost i gas) i kablove kroz rupu u zidu sa spoljašnje strane ili ih provucite iznutra nakon povezivanja cevi i kablova unutrašnje jedinice kako biste ih priključili na spoljašnju jedinicu.
- Odsecite višak cevi u skladu sa smerom cevi (kao što je prikazano u nastavku)

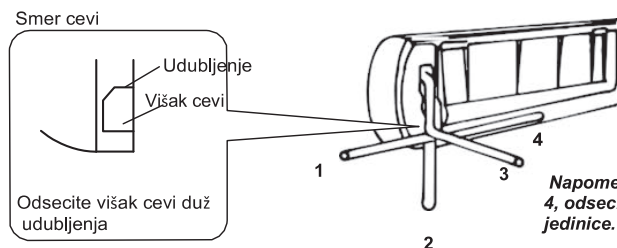

Napomena: kada cev postavljate u smeru 1, 2 ili 4, odsecite višak iste sa osnove unutrašnje jedinice.

- Nakon pravilnog priključivanja cevi, postavite odvodno crevo. Posle toga povežite električne kablove. Nakon povezivanja, zajedno obmotajte cev, kablove i odvodno crevo termoizolacionim materijalima.

Uputstva za ugradnju



- **Termoizolacija spojeva cevi:**
Spojeve cevi obmotajte termoizolacionim materijalima, a zatim vinil trakom.

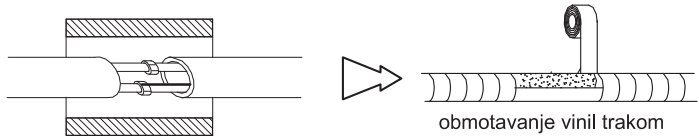

Termoizolacija

obmotavanje vinil trakom

- **Termoizolacija cevi:**

- Postavite odvodno crevo ispod cevi.
- Izolacioni materijal treba da bude od polietilenske pene debljine preko 6 mm.

Napomena: odvodno crevo priprema korisnik.

- Odvodna cev treba da ima pad radi lakšeg oticanja. Odvodna cev ne sme biti uvijena ili iskrivljena i njen kraj ne sme biti potopljen u vodu.

Ako se na odvodnu cev poveže produžno odvodno crevo, proverite da li ima termoizolaciju do unutrašnje jedinice.

- Kada je cev usmerena nadesno, cev, električni kabl i odvodna cev treba da imaju termoizolaciju i da budu pričvršćeni na zadnjoj strani jedinice pomoću pričvršćivača cevi.

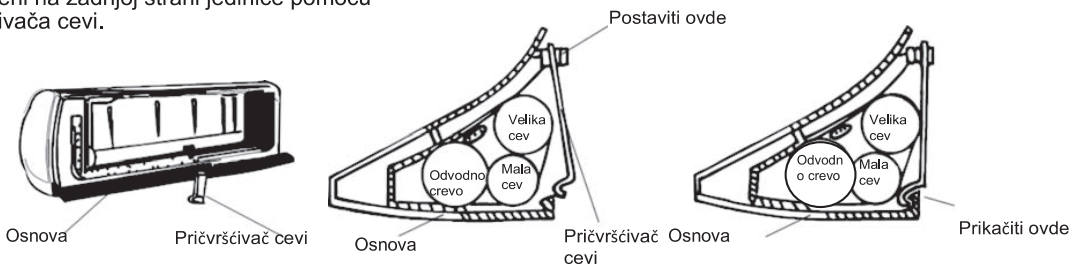
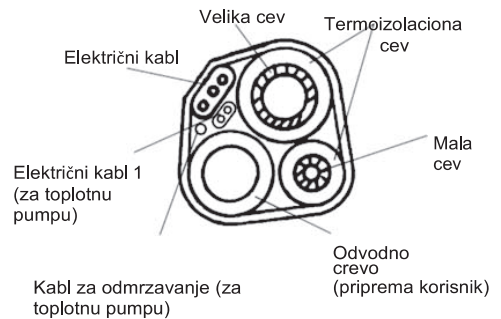

A. Postaviti pričvršćivač cevi u žleb.

B. Pritisnite kako biste pričvršćivač cevi prikačili na osnovu.

Povezivanje cevi:

- Povežite cevi unutrašnje jedinice pomoću dva ključa. Vodite računa o potrebnom zateznom momentu, kao što je prikazano u nastavku, a kako ne bi došlo do deformacije ili oštećenja cevi, priključaka i navrtki.



Model	Dimenzije cevi	Moment	Širina navrtke	Min. debljina
5,7,8,9,10,12,14,15,18,24K	Strana tečnosti (Φ6mm ili 1/4 inča)	15~20N·m	17 mm	0,5 mm
18K*,22,24K*,28,30,36K	Strana tečnosti (Φ9,53mm ili 3/8 inča)	30~35N·m	22 mm	0,6 mm
5,7,8,9,10K	Strana gasa (Φ9,53mm ili 3/8 inča)	30~35N·m	22 mm	0,6 mm
12,14,15,18K	Strana gasa (Φ12mm ili 1/2 inča)	50~55N·m	24 mm	0,6 mm
18K*,22,24,28,30,36K	Strana gasa (Φ16mm ili 5/8 inča)	60~65N·m	27 mm	0,6 mm
36K*	Strana gasa (Φ19mm ili 3/4 inča)	70~75N·m	32 mm	1,0 mm

Jedinica modela 12K, 18K*, 24K*, 30K*, 36K* je veća od jedinice modela 12K, 18K, 24K, 30K, 36K.

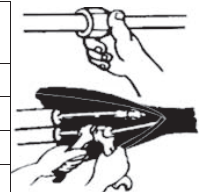

Uputstva za ugradnju

4. Povezivanje kabla

• Unutrašnja jedinica

Povežite priključni kabl na unutrašnju jedinicu povezivanjem pojedinačnih žica na terminale na kontrolnoj tabli u skladu sa konekcijom spoljašnje jedinice.

Napomena: kod nekih modela je potrebno izvoditi pregradu radi povezivanja na terminal unutrašnje jedinice.

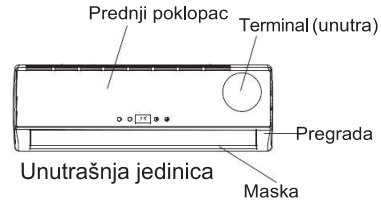

• Spoljašnja jedinica

- 1). Skinite vrata za pristup sa jedinice odvijanjem šrafa. Povežite pojedinačne žice na terminale na kontrolnoj tabli kao što sledi.
- 2). Pričvrstite priključni kabl na kontrolnu tablu pomoću kablovske obujmice.
- 3). Postavite vrata na prvobitno mesto pomoću šrafa.
- 4) Postavite odobreni prekidač za model 24K ili novije modele između izvora napajanja i jedinice. Uređaj za prekid strujnog kola se mora ugraditi za pravilno isključivanje napajanja.

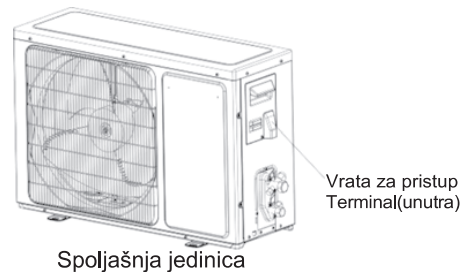

■ Na slikama iz ovog uputstva je prikazan spoljašnji izgled standardnog modela. Zbog toga se oblik klima uređaja koji ste odabrali može razlikovati.

Oprez:

1. Posebno strujno kolo samo za klima uređaj je obavezno. Način povezivanja žica je prikazan na šemi kola sa unutrašnje strane vrata za pristup.
2. Proverite da li debljina kabla odgovara specifikacijama izvora napajanja.
3. Nakon povezivanja kablova proverite da li su žice dobro pričvršćene.
4. Obavezno ugradite prekidač kola protiv gubitka struje (ELCB) u mokrim i vlažnim prostorijama.

Kapacitet (Btu/h)	Priključni kabl		Električni kabl		Električni kabl 1		Glavno napajanje
	Tip	Poprečni presek	Tip	Poprečni presek	Tip	Poprečni presek	
5K~13K	H05VV-F	1,0~1,5mm2X3	H07RN-F H05RN-F	1,5mm2X3 1,0mm2X3	H05RN-F	0,75mm2X2 (toplotna pumpa)	Unutraš. jed.
14K~24K	H05VV-F	1,5~2,5mm2X3	H07RN-F	1,5-2,5mm2X3	H05RN-F	0,75mm2X2 (toplotna pumpa)	Unutraš. jed.
18K~30K	H05VV-F	1,5-2,5mm2X3	H07RN-F	1,5-2,5mm2X4	H05RN-F	0,75mm2X2 (toplotna pumpa i opciono)	Unutraš. jed.
18K~30K	H07RN-F	2,5mm2X3	H05RN-F H07RN-F	1,0mm2X3 1,0mm2X4samo hlađenje	H05RN-F	0,75mm2X3 (toplotna pumpa)	Spoljaš. jed.
24K~36K	H07RN-F	2,5~4,0mm2X3	H05RN-F H07RN-F	0,75mm2X4 1,0mm2X4	H05RN-F	0,75mm2X2 (toplotna pumpa i opciono)	Spoljaš. jed.
24K~36K	H07RN-F	1,5mm2X5	H05RN-F	0,75mm2X4	H05RN-F	0,75mm2X2 (toplotna pumpa)	Spoljaš. jed.

Kabl se može razlikovati od gore date liste. Može se koristiti u skladu sa sledećom listom. Može biti i veći.
 0-7A, koristiti 0,75mm² ili 18AWG. 0-10A, koristiti 1mm² ili 16AWG. 0-16A, koristiti 1,5mm² ili 14AWG.
 0-20A, koristiti 2,5mm² ili 14AWG. 0-25A, koristiti 2,5mm² ili 12AWG. 0-32A, koristiti 4mm² ili 12AWG.

Uputstva za ugradnju

Šema ožičenja

Upozorenje: pre nego što pristupite terminalima isključite svo napajanje.

Napomena: sve žice moraju biti različitih boja. Indikatori „1L 2L 3L“ mogu biti „4 5 6“ ili drugi.

Terminal se može razlikovati od fizičkog predmeta.

• Model 5K~24K

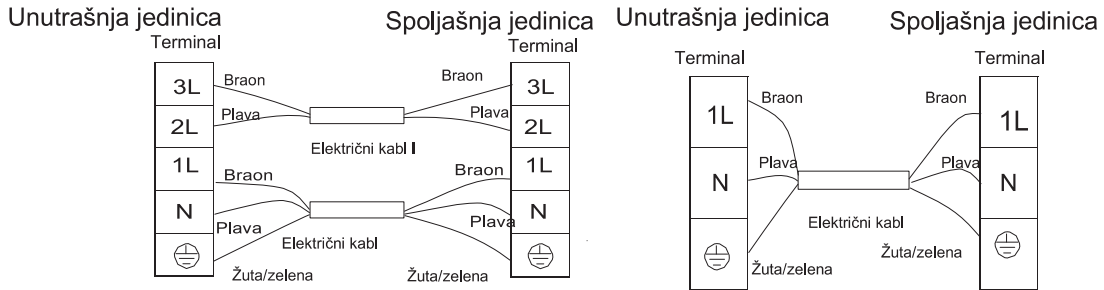

Kod gore navedenih modela, napajanje se priključuje sa unutrašnje jedinice.

Kod ovih modela, uzemljenje se može povezati direktno na električnu kutiju.

• Model 18K~30K

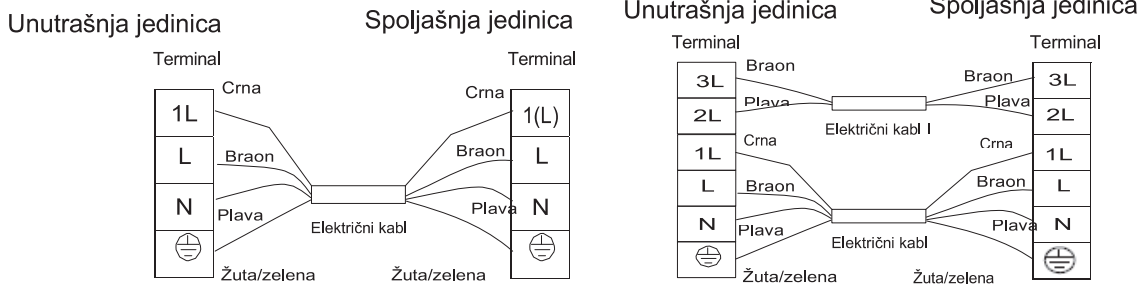

Kod gore navedenih modela, napajanje se priključuje sa unutrašnje jedinice.

Kod ovih modela, uzemljenje se može povezati direktno na električnu kutiju.

• Model 18K~30K

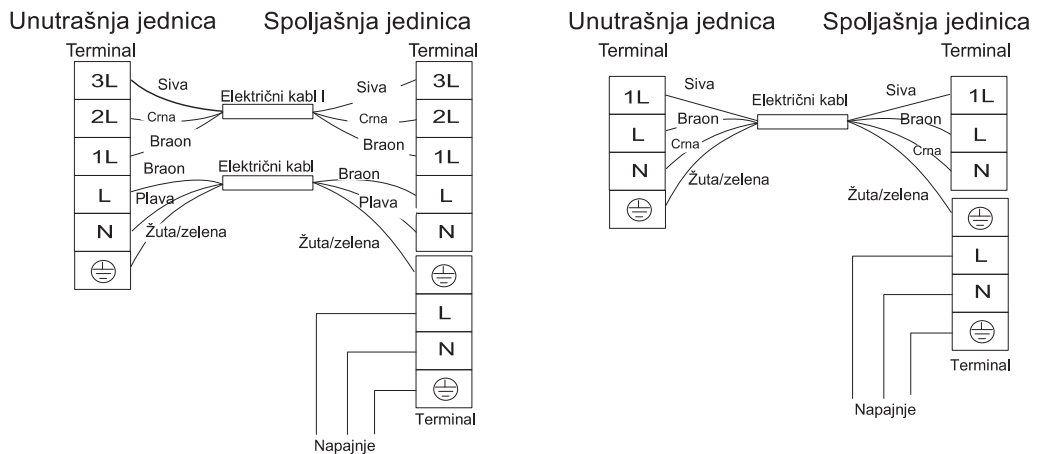

Kod ovih modela napajanje se povezuje sa spoljašnje jedinice, sa prekidačem.

Uputstva za ugradnju

Upozorenje: pre nego što pristupite terminalima isključite svo napajanje.

Napomena: sve žice moraju biti različitih boja. Indikatori „1L 2L 3L“ mogu biti „4 5 6“ ili drugi.

Terminal se može razlikovati od fizičkog predmeta.

• Model 24K~36K

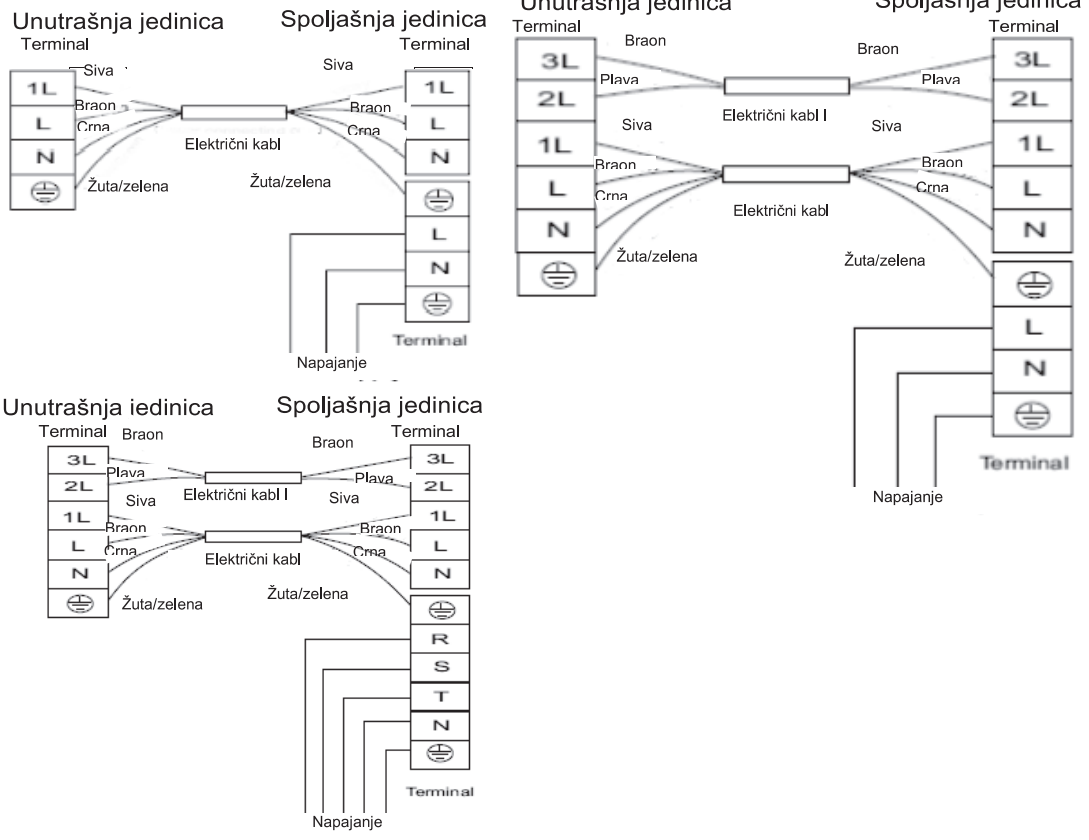

Kod ovih modela napajanje se povezuje sa spoljašnje jedinice, sa prekidačem. Sve žice mogu biti različitih boja.

- Kabl za odmrzavanje (samo kod klima uređaja sa toplotnom pumpom i to je opcioni deo)

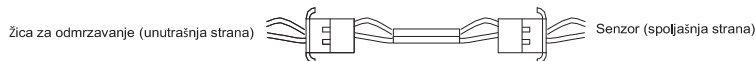

Nakon povezivanja, žicu za odmrzavanje treba dobro obmotati trakom, a priključak se stavlja unutar jedinice.

- Kabl za zaštitu od pregrevanja ili visokog pritiska (opcioni deo)

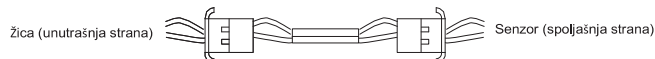

Nakon povezivanja, žicu za odmrzavanje treba dobro obmotati trakom, a priključak se stavlja unutar jedinice.

- Jonizator (jonizator je opcioni deo)

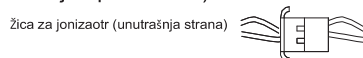

Nakon povezivanja, jonizator automatski radi.

Uputstva za ugradnju

Ugradnja spoljašnje jedinice

1. Ugradite odvodni port i odvodno crevo samo kod modela sa toplotnom pumpom. Kondenzovana tečnost otiče sa spoljašnje jedinice kada jedinica radi u režimu grejanja. Kako ne biste smetali susedima i kako biste zaštitili životnu sredinu, ugradite odvodni port i odvodno crevo za oticanje kondenzovane vode. Najpre ugradite odvodni port i gumenu podlošku na masku spoljašnje jedinice, a zatim povežite odvodno crevo na port kao što je prikazano na slici desno.
2. Postavite i pričvrstite spoljašnju jedinicu
Dobro pričvrstite šrafovim i navrtkama na ravan i čvrst pod.
Ako se ugrađuje na zid ili krov, dobro pričvrstite na nosač kako ne bi došlo do podrhtavanja usled većih vibracija ili jakog vetra.
3. Povezivanje cevi spoljašnje jedinice
 - Skinuti poklopce sa dvosmernog i trosmernog ventila.
 - Posebno povežite cevi na dvosmerni i trosmerni ventil prema odgovarajućem zateznom momentu.
4. Povezivanje kablova spoljašnje jedinice (videti prethodnu stranu).

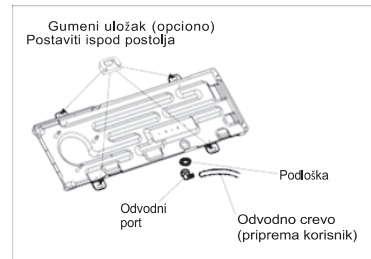

Čišćenje vazduhom

Vazduh koji sadrži vlagu iz ciklusa hlađenja može dovesti do kvara kompresora. Posle povezivanja unutrašnje i spoljašnje jedinice, izbacite vazduh i vlagu iz ciklusa hlađenja pomoću vakuumpumpe, kao što je prikazano u nastavku.

Napomena: da biste zaštitili životnu sredinu, nemojte direktno ispuštati rashladno sredstvo u vazduh. Videti postupak čišćenja vazduhom na sledećoj strani.

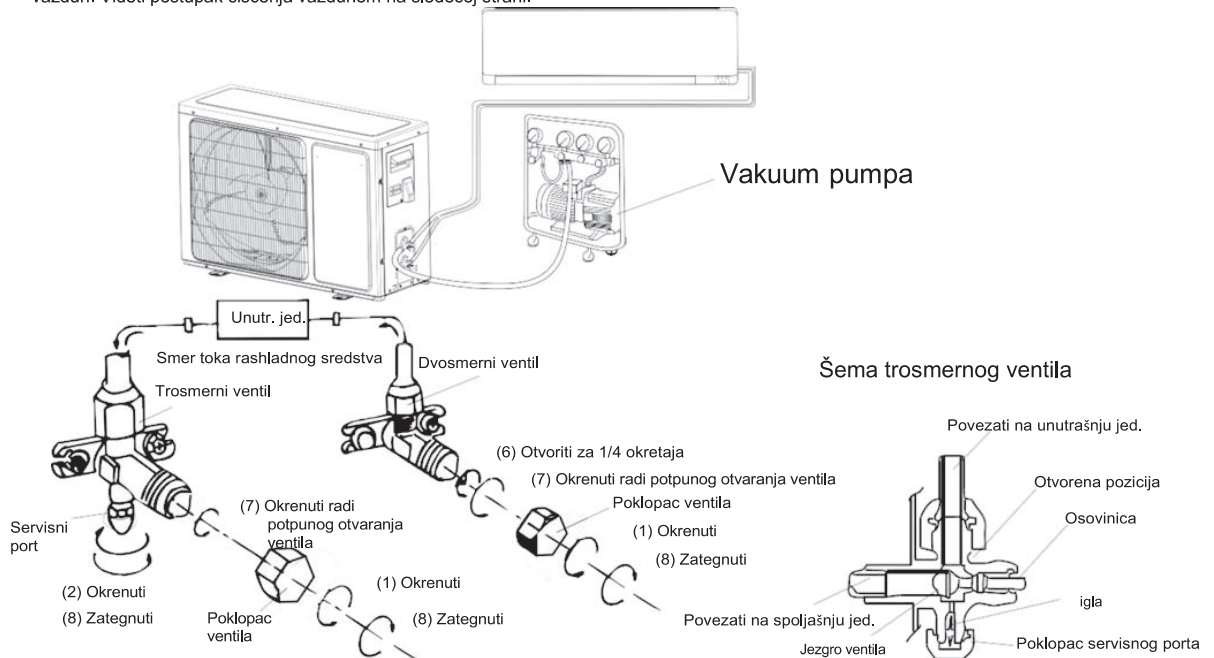

Uputstva za ugradnju

Kako čistiti cevi vazduhom:

- (1). Odvijanjem skinuti poklopce dvosmernog i trosmernog ventila.
- (2). Odvijanjem skinuti poklopac sa servisnog ventila.
- (3). Povezati savitljivo crevo vakuum pumpe na servisni ventil.
- (4). Pokrenuti vakuum pumpu na 10–15 minuta dok se ne dostigne vakuum od 10 mm Hg apsolutnog pritiska.
- (5). Dok vakuum pumpa još radi zatvorite ručicu za nizak pritisak na manipulativnom cevovodu vakuum pumpe. Zatim isključite vakuum pumpu.
- (6). Otvorite dvosmerni ventil za 1/4 okretaja, a zatim ga zatvorite posle 10 sekundi. Proverite zaptivenost svih spojeva pomoću tečnog sapuna ili elektronskog detektora curenja.
- (7). Okrenite osnovu dvosmernog i trosmernog ventila kako biste ih zatvorili. Skinite savitljivo crevo vakuum pumpe.
- (8). Zamenite i pričvrstite sve poklopce ventila.

Ovaj dokument je originalno proizveden i objavljen od strane proizvođača, brenda Hisense, i preuzet je sa njihove zvanične stranice. S obzirom na ovu činjenicu, Tehnoteka ističe da ne preuzima odgovornost za tačnost, celovitost ili pouzdanost informacija, podataka, mišljenja, saveta ili izjava sadržanih u ovom dokumentu.

Napominjemo da Tehnoteka nema ovlašćenje da izvrši bilo kakve izmene ili dopune na ovom dokumentu, stoga nismo odgovorni za eventualne greške, propuste ili netačnosti koje se mogu naći unutar njega. Tehnoteka ne odgovara za štetu nanесenu korisnicima pri upotrebi netačnih podataka. Ukoliko imate dodatna pitanja o proizvodu, ljubazno vas molimo da kontaktirate direktno proizvođača kako biste dobili sve detaljne informacije.

Za najnovije informacije o ceni, dostupnim akcijama i tehničkim karakteristikama proizvoda koji se pominje u ovom dokumentu, molimo posetite našu stranicu klikom na sledeći link:

<https://tehnoteka.rs/p/hisense-klima-v-pie-tv35vd1g-akcija-cena/>